

## Aluminum electrolytic capacitors

Capacitors with 4-pin snap-in terminals and solder pins

**Series/Type:** B43511, B43521

**Date:** November 2012

© EPCOS AG 2015. Reproduction, publication and dissemination of this publication, enclosures hereto and the information contained therein without EPCOS' prior express consent is prohibited.

EPCOS AG is a TDK Group Company.

### Long-life grade capacitors

#### Applications

- Frequency converters
- Solar inverters
- Uninterruptible power supplies
- Professional power supplies
- Medical appliances

#### Features

- Voltage derating ( $0.95 \cdot V_R$ ) enables 105 °C operation, more details available upon request
- Long useful life
- Outstanding ripple current capability
- High volumetric efficiency
- Many different case sizes
- Pinning ensures correct insertion
- RoHS-compatible

#### Construction

- Charge/discharge-proof, polar
- Aluminum case, fully insulated with PVC
- Version with additional PET insulation cap on terminal side available for insulating the capacitor from the PCB (B43511 only)
- Overload protection by safety vent on the case wall

#### Terminals

- 4-pin snap-in terminals (6.3 mm and 4.5 mm length)
- Solder pin mounting on printed circuit boards, pins fit standardized spacings on PCB



B43511

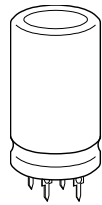

B43521

**Specifications and characteristics in brief**

| Rated voltage $V_R$   | 350 ... 450 V DC   |   |                      |                   |  |   |   |  |   |    |  |  |
|---|--|---|----------------------|-------------------|--|---|---|--|---|----|--|--|
| Surge voltage $V_S$   | $1.1 \cdot V_R$  |   |                      |                   |  |   |   |  |   |    |  |  |
| Rated capacitance $C_R$   | 390 ... 2200 $\mu\text{F}$   |   |                      |                   |  |   |   |  |   |    |  |  |
| Capacitance tolerance   | $\pm 20\% \triangle M$   |   |                      |                   |  |   |   |  |   |    |  |  |
| Dissipation factor $\tan \delta$<br>(20 °C, 120 Hz)   | $V_R \leq 400 \text{ V DC: } \tan \delta \leq 0.15$<br>$V_R > 400 \text{ V DC: } \tan \delta \leq 0.20$  |   |                      |                   |  |   |   |  |   |    |  |  |
| Leakage current $I_{\text{leak}}$<br>(5 min, 20 °C)   | $I_{\text{leak}} \leq 0.3 \mu\text{A} \cdot \left( \frac{C_R}{\mu\text{F}} \cdot \frac{V_R}{\text{V}} \right)^{0.7} + 4 \mu\text{A}$   |   |                      |                   |  |   |   |  |   |    |  |  |
| Self-inductance ESL   | Approx. 20 nH  |   |                      |                   |  |   |   |  |   |    |  |  |
| Useful life <sup>1)</sup><br>85 °C; $V_R$ ; $I_{\text{AC,R}}$<br>40 °C; $V_R$ ; $1.6 \cdot I_{\text{AC,R}}$ | $> 12000 \text{ h}$<br>$> 200000 \text{ h}$  | <b>Requirements:</b><br>$\Delta C/C \leq \pm 20\%$ of initial value<br>$\tan \delta \leq 2$ times initial specified limit<br>$I_{\text{leak}} \leq$ initial specified limit             |                      |                   |  |   |   |  |   |    |  |  |
| Voltage endurance test<br>85 °C; $V_R$  | 3000 h   | <b>Post test requirements:</b><br>$\Delta C/C \leq \pm 10\%$ of initial value<br>$\tan \delta \leq 1.3$ times initial specified limit<br>$I_{\text{leak}} \leq$ initial specified limit |                      |                   |  |   |   |  |   |    |  |  |
| Vibration resistance test   | To IEC 60068-2-6, test Fc:<br>Frequency range 10 ... 55 Hz, displacement amplitude 0.35 mm, acceleration max. 5 g, duration $3 \times 2 \text{ h}$ .<br>Capacitor mounted by its body which is rigidly clamped to the work surface.  |   |                      |                   |  |   |   |  |   |    |  |  |
| Characteristics at low temperature  | Max. impedance ratio at 100 Hz <table border="1" data-bbox="568 986 912 1114" style="margin-left: 20px;"> <thead> <tr> <th><math>V_R</math></th> <th><math>\leq 400 \text{ V}</math></th> <th><math>&gt; 400 \text{ V}</math></th> </tr> </thead> <tbody> <tr> <td><math>Z_{-25\text{ °C}} / Z_{20\text{ °C}}</math></td> <td>4</td> <td>7</td> </tr> <tr> <td><math>Z_{-40\text{ °C}} / Z_{20\text{ °C}}</math></td> <td>7</td> <td>14</td> </tr> </tbody> </table> | $V_R$   | $\leq 400 \text{ V}$ | $> 400 \text{ V}$ | $Z_{-25\text{ °C}} / Z_{20\text{ °C}}$ | 4 | 7 | $Z_{-40\text{ °C}} / Z_{20\text{ °C}}$ | 7 | 14 |  |  |
| $V_R$   | $\leq 400 \text{ V}$   | $> 400 \text{ V}$   |                      |                   |  |   |   |  |   |    |  |  |
| $Z_{-25\text{ °C}} / Z_{20\text{ °C}}$  | 4  | 7   |                      |                   |  |   |   |  |   |    |  |  |
| $Z_{-40\text{ °C}} / Z_{20\text{ °C}}$  | 7  | 14  |                      |                   |  |   |   |  |   |    |  |  |
| IEC climatic category   | To IEC 60068-1:<br>$V_R \leq 400 \text{ V DC: } 40/085/56$ (–40 °C/+85 °C/56 days damp heat test)<br>$V_R > 400 \text{ V DC: } 25/085/56$ (–25 °C/+85 °C/56 days damp heat test)<br>The capacitors can be operated in the temperature range of –40 °C to +85 °C but the impedance at –40 °C should be taken into consideration.  |   |                      |                   |  |   |   |  |   |    |  |  |
| Detail specification  | Similar to CECC 30301-805  |   |                      |                   |  |   |   |  |   |    |  |  |
| Sectional specification   | IEC 60384-4  |   |                      |                   |  |   |   |  |   |    |  |  |

1) Refer to chapter "General technical information, 5 Useful life" on how to interpret useful life.



**B43511, B43521**

**Outstanding ripple current – 85 °C**

**Dimensional drawings**

**B43511, 4-pin snap-in terminals, PVC insulation**



| Dimensions (mm) |      | Approx. weight (g) | Packing units (pcs.) |
|-----------------|------|--------------------|----------------------|
| d +1            | l ±2 |                    |                      |
| 35              | 50   | 63                 | 60                   |
| 35              | 60   | 76                 | 36                   |
| 35              | 70   | 88                 | 36                   |
| 35              | 80   | 101                | 36                   |
| 35              | 100  | 126                | 36                   |
| 40              | 40   | 71                 | 33                   |
| 40              | 50   | 89                 | 33                   |
| 40              | 60   | 107                | 33                   |
| 40              | 70   | 125                | 33                   |
| 40              | 80   | 143                | 33                   |
| 40              | 100  | 178                | 33                   |
| 45              | 40   | 90                 | 28                   |
| 45              | 50   | 113                | 28                   |
| 45              | 60   | 136                | 28                   |
| 45              | 70   | 158                | 28                   |
| 45              | 80   | 181                | 28                   |
| 45              | 100  | 226                | 28                   |

Standard snap-in terminals:

length (6.3 ± 1) mm.

Also available with length of (4.5 – 1) mm.

All pin holes must be drilled into the PC-board, since the unconnected pins serve as mountings. These pins must be soldered to isolated pads or pads with the same potential as the negative pole.



**B43511, 4-pin snap-in terminals, PVC insulation and PET insulation cap on terminal side**

| Dimensions (mm) |           | Approx. weight (g) | Packing units (pcs.) |
|-----------------|-----------|--------------------|----------------------|
| d +1.4          | l +2.2/-2 |                    |                      |
| 35              | 50        | 63                 | 60                   |
| 35              | 60        | 76                 | 36                   |
| 35              | 70        | 88                 | 36                   |
| 35              | 80        | 101                | 36                   |
| 35              | 100       | 126                | 36                   |
| 40              | 40        | 71                 | 33                   |
| 40              | 50        | 89                 | 33                   |
| 40              | 60        | 107                | 33                   |
| 40              | 70        | 125                | 33                   |
| 40              | 80        | 143                | 33                   |
| 40              | 100       | 178                | 33                   |
| 45              | 40        | 90                 | 28                   |
| 45              | 50        | 113                | 28                   |
| 45              | 60        | 136                | 28                   |
| 45              | 70        | 158                | 28                   |
| 45              | 80        | 181                | 28                   |
| 45              | 100       | 226                | 28                   |

Standard snap-in terminals:

length (6.3 +1/-1.4) mm. Also available with length of (4.5 -1.4) mm. PET insulation cap is positioned under the insulation sleeve.

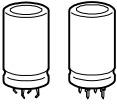
All pin holes must be drilled into the PC-board, since the unconnected pins serve as mountings. These pins must be soldered to isolated pads or pads with the same potential as the negative pole.



**B43511, B43521**

**Outstanding ripple current – 85 °C**

**B43521, solder pins**

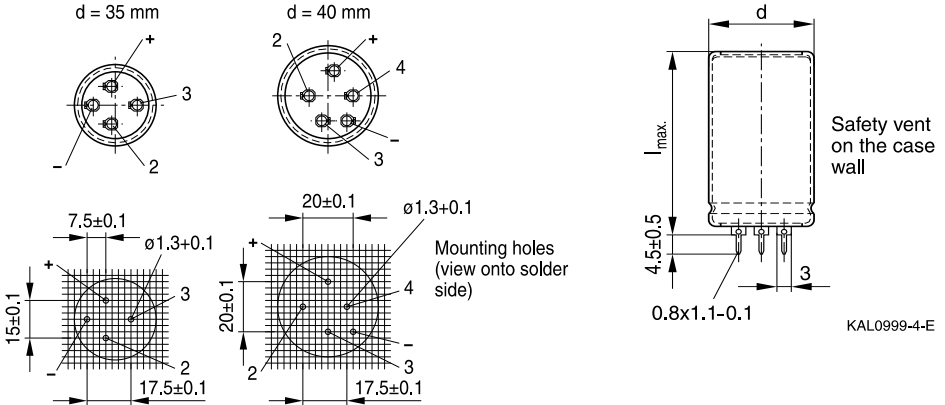

Pole markings: Plus: +; Minus: –

All pin holes must be drilled into the PC-board, since the unconnected pins serve as mountings. These pins must be soldered to isolated pads or pads with the same potential as the negative pole.

| Dimensions (mm) |                  | Approx. weight (g) | Packing units (pcs.) |
|-----------------|------------------|--------------------|----------------------|
| d +1            | l <sub>max</sub> |                    |                      |
| 35              | 54               | 63                 | 60                   |
| 35              | 64               | 76                 | 36                   |
| 35              | 74               | 88                 | 36                   |
| 35              | 84               | 101                | 36                   |
| 35              | 104              | 126                | 36                   |
| 40              | 44               | 71                 | 33                   |
| 40              | 54               | 89                 | 33                   |
| 40              | 64               | 107                | 33                   |
| 40              | 74               | 125                | 33                   |
| 40              | 84               | 143                | 33                   |
| 40              | 104              | 178                | 33                   |



**Packing of 4-pin snap-in terminal and solder pin capacitors**



For ecological reasons the packing is pure cardboard.

**Ordering codes for terminal styles and insulation features**

Identification in 3rd block of ordering code

4-pin snap-in terminal capacitors

| Terminal version          | Insulation version |                  |
|---------------------------|--------------------|------------------|
|                           | PVC                | PVC plus PET cap |
| Standard terminals 6.3 mm | M000               | M080             |
| Short terminals 4.5 mm    | M007               | M087             |

Ordering examples:

B43511A9188M007 } 4-pin snap-in capacitor with short terminals and standard PVC insulation

B43511A9188M080 } 4-pin snap-in capacitor with standard terminals and PVC insulation with additional PET insulation cap on terminal side

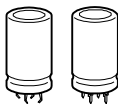
**B43511, B43521**
**Outstanding ripple current – 85 °C**
**Overview of available types**

| $V_R$ (V DC)            | 350                               | 400                            | 420                            | 450                           |
|-------------------------|-----------------------------------|--------------------------------|--------------------------------|-------------------------------|
|                         | Case dimensions $d \times l$ (mm) |                                |                                |                               |
| $C_R$ ( $\mu\text{F}$ ) |                                   |                                |                                |                               |
| 390                     |                                   |                                |                                | 35 × 50<br>40 × 40            |
| 470                     |                                   | 35 × 50<br>40 × 40             | 35 × 50<br>40 × 40             | 35 × 60<br>40 × 50<br>45 × 40 |
| 560                     | 35 × 50                           | 35 × 60<br>45 × 40             | 35 × 60<br>40 × 50             | 35 × 70<br>40 × 60            |
| 680                     | 35 × 60<br>40 × 50                | 35 × 70<br>40 × 60<br>45 × 50  | 35 × 70<br>40 × 60<br>45 × 50  | 35 × 80<br>40 × 60<br>45 × 50 |
| 820                     | 35 × 70<br>40 × 60                | 35 × 80<br>40 × 60             | 35 × 80<br>40 × 70<br>45 × 50  | 40 × 70<br>45 × 60            |
| 1000                    | 35 × 80<br>40 × 60<br>45 × 50     | 35 × 100<br>40 × 70<br>45 × 60 | 35 × 100<br>40 × 80<br>45 × 60 | 40 × 100<br>45 × 70           |
| 1500                    | 40 × 80<br>45 × 70                | 40 × 100<br>45 × 80            | 40 × 100<br>45 × 80            | 45 × 100                      |
| 1800                    |                                   | 45 × 100                       | 45 × 100                       |                               |
| 2200                    | 45 × 100                          |                                |                                |                               |

The capacitance and voltage ratings listed above are available in different cases upon request.

Other voltage and capacitance ratings are also available upon request.

Capacitors with solder pins are only available in 35 and 40 mm case diameters.



**Technical data and ordering codes**

| $C_R$<br>100 Hz<br>20 °C<br>$\mu\text{F}$  | Case<br>dimensions<br>$d \times l$<br>mm | ESR <sub>typ</sub><br>100 Hz<br>20 °C<br>m $\Omega$ | $Z_{\text{max}}$<br>10 kHz<br>20 °C<br>m $\Omega$ | $I_{\text{AC,max}}$<br>100 Hz<br>60 °C<br>A | $I_{\text{AC,R}}$<br>100 Hz<br>85 °C<br>A | Ordering code<br>(composition see<br>below) |
|--|--|---|---|---|---|---|
| <b><math>V_R = 350 \text{ V DC}</math></b> |  |   |   |   |   |   |
| 560  | 35 × 50                                  | 160   | 190   | 5.7   | 3.2                                       | B435*1A4567M0##                             |
| 680  | 35 × 60                                  | 140   | 150   | 6.7   | 3.7                                       | B435*1A4687M0##                             |
| 680  | 40 × 50                                  | 140   | 150   | 6.6   | 3.7                                       | B435*1C4687M0##                             |
| 820  | 35 × 70                                  | 110   | 130   | 7.8   | 4.4                                       | B435*1A4827M0##                             |
| 820  | 40 × 60                                  | 110   | 130   | 7.8   | 4.3                                       | B435*1C4827M0##                             |
| 1000                                       | 35 × 80                                  | 90  | 110   | 9.2   | 5.1                                       | B435*1A4108M0##                             |
| 1000                                       | 40 × 60                                  | 90  | 110   | 8.6   | 4.8                                       | B435*1C4108M0##                             |
| 1000                                       | 45 × 50                                  | 90  | 110   | 8.1   | 4.5                                       | B43511E4108M0##                             |
| 1500                                       | 40 × 80                                  | 60  | 70  | 11.8  | 6.5                                       | B435*1A4158M0##                             |
| 1500                                       | 45 × 70                                  | 60  | 70  | 11.2  | 6.2                                       | B43511C4158M0##                             |
| 2200                                       | 45 × 100                                 | 50  | 50  | 15.6  | 8.6                                       | B43511A4228M0##                             |
| <b><math>V_R = 400 \text{ V DC}</math></b> |  |   |   |   |   |   |
| 470  | 35 × 50                                  | 190   | 220   | 5.2   | 2.9                                       | B435*1A9477M0##                             |
| 470  | 40 × 40                                  | 190   | 220   | 5.1   | 2.8                                       | B435*1C9477M0##                             |
| 560  | 35 × 60                                  | 160   | 190   | 6.1   | 3.4                                       | B435*1A9567M0##                             |
| 560  | 45 × 40                                  | 160   | 190   | 5.6   | 3.1                                       | B43511C9567M0##                             |
| 680  | 35 × 70                                  | 140   | 150   | 7.1   | 4.0                                       | B435*1A9687M0##                             |
| 680  | 40 × 60                                  | 140   | 150   | 7.1   | 3.9                                       | B435*1C9687M0##                             |
| 680  | 45 × 50                                  | 140   | 150   | 6.6   | 3.7                                       | B43511E9687M0##                             |
| 820  | 35 × 80                                  | 110   | 130   | 8.3   | 4.6                                       | B435*1A9827M0##                             |

Capacitors with solder pins are only available in 35 and 40 mm case diameters.

**Composition of ordering code**

\* = Terminal type

1 = 4-pin snap-in terminals

2 = solder pin

## = Terminal style and insulation feature

00 = solder pin or 4-pin snap-in standard terminals and PVC insulation

07 = 4-pin snap-in short terminals and PVC insulation

80 = 4-pin snap-in standard terminals and PVC insulation with additional PET insulation cap on terminal side

87 = 4-pin snap-in short terminals and PVC insulation with additional PET insulation cap on terminal side

**B43511, B43521**
**Outstanding ripple current – 85 °C**
**Technical data and ordering codes**

| $C_R$<br>100 Hz<br>20 °C<br>μF  | Case<br>dimensions<br>d × l<br>mm | ESR <sub>typ</sub><br>100 Hz<br>20 °C<br>mΩ | Z <sub>max</sub><br>10 kHz<br>20 °C<br>mΩ | I <sub>AC,max</sub><br>100 Hz<br>60 °C<br>A | I <sub>AC,R</sub><br>100 Hz<br>85 °C<br>A | Ordering code<br>(composition see<br>below) |
|---------------------------------|-----------------------------------|---|---|---|---|---|
| <b>V<sub>R</sub> = 400 V DC</b> |                                   |   |   |   |   |   |
| 820                             | 40 × 60                           | 110   | 130                                       | 7.8   | 4.3                                       | B435*1C9827M0##                             |
| 1000                            | 35 × 100                          | 90  | 110                                       | 10.1  | 5.6                                       | B435*1C9108M0##                             |
| 1000                            | 40 × 70                           | 90  | 110                                       | 9.1   | 5.1                                       | B435*1A9108M0##                             |
| 1000                            | 45 × 60                           | 90  | 110                                       | 8.6   | 4.8                                       | B435*1B9108M0##                             |
| 1500                            | 40 × 100                          | 60  | 70  | 12.9  | 7.2                                       | B435*1A9158M0##                             |
| 1500                            | 45 × 80                           | 60  | 70  | 11.8  | 6.5                                       | B43511C9158M0##                             |
| 1800                            | 45 × 100                          | 50  | 60  | 14.1  | 7.8                                       | B43511A9188M0##                             |
| <b>V<sub>R</sub> = 420 V DC</b> |                                   |   |   |   |   |   |
| 470                             | 35 × 50                           | 320   | 340                                       | 5.2   | 2.9                                       | B435*1A0477M0##                             |
| 470                             | 40 × 40                           | 320   | 340                                       | 5.1   | 2.8                                       | B435*1C0477M0##                             |
| 560                             | 35 × 60                           | 270   | 290                                       | 6.1   | 3.4                                       | B435*1A0567M0##                             |
| 560                             | 40 × 50                           | 270   | 290                                       | 6.0   | 3.3                                       | B435*1C0567M0##                             |
| 680                             | 35 × 70                           | 230   | 240                                       | 7.1   | 4.0                                       | B435*1A0687M0##                             |
| 680                             | 40 × 60                           | 230   | 240                                       | 7.1   | 3.9                                       | B435*1C0687M0##                             |
| 680                             | 45 × 50                           | 230   | 240                                       | 6.6   | 3.7                                       | B43511E0687M0##                             |
| 820                             | 35 × 80                           | 190   | 200                                       | 8.3   | 4.6                                       | B435*1A0827M0##                             |
| 820                             | 40 × 70                           | 190   | 200                                       | 8.2   | 4.6                                       | B435*1C0827M0##                             |
| 820                             | 45 × 50                           | 190   | 200                                       | 7.3   | 4.1                                       | B43511E0827M0##                             |
| 1000                            | 35 × 100                          | 160   | 160                                       | 10.1  | 5.6                                       | B435*1A0108M0##                             |
| 1000                            | 40 × 80                           | 160   | 160                                       | 9.6   | 5.3                                       | B435*1C0108M0##                             |
| 1000                            | 45 × 60                           | 160   | 160                                       | 8.6   | 4.8                                       | B43511E0108M0##                             |
| 1500                            | 40 × 100                          | 110   | 110                                       | 12.9  | 7.2                                       | B435*1A0158M0##                             |
| 1500                            | 45 × 80                           | 110   | 110                                       | 11.8  | 6.5                                       | B43511C0158M0##                             |
| 1800                            | 45 × 100                          | 90  | 90  | 14.1  | 7.8                                       | B43511A0188M0##                             |

Capacitors with solder pins are only available in 35 and 40 mm case diameters.

**Composition of ordering code**

\* = Terminal type

1 = 4-pin snap-in terminals

2 = solder pin

## = Terminal style and insulation feature

00 = solder pin or 4-pin snap-in standard terminals and PVC insulation

07 = 4-pin snap-in short terminals and PVC insulation

80 = 4-pin snap-in standard terminals and PVC insulation with additional PET insulation cap on terminal side

87 = 4-pin snap-in short terminals and PVC insulation with additional PET insulation cap on terminal side

**Technical data and ordering codes**

| $C_R$<br>100 Hz<br>20 °C<br>μF  | Case<br>dimensions<br>d × l<br>mm | ESR <sub>typ</sub><br>100 Hz<br>20 °C<br>mΩ | Z <sub>max</sub><br>10 kHz<br>20 °C<br>mΩ | I <sub>AC,max</sub><br>100 Hz<br>60 °C<br>A | I <sub>AC,R</sub><br>100 Hz<br>85 °C<br>A | Ordering code<br>(composition see<br>below) |
|---------------------------------|-----------------------------------|---|---|---|---|---|
| <b>V<sub>R</sub> = 450 V DC</b> |                                   |   |   |   |   |   |
| 390                             | 35 × 50                           | 390   | 410                                       | 4.7   | 2.6                                       | B435*1A5397M0##                             |
| 390                             | 40 × 40                           | 390   | 410                                       | 4.6   | 2.6                                       | B435*1C5397M0##                             |
| 470                             | 35 × 60                           | 320   | 340                                       | 5.6   | 3.1                                       | B435*1A5477M0##                             |
| 470                             | 40 × 50                           | 320   | 340                                       | 5.5   | 3.1                                       | B435*1C5477M0##                             |
| 470                             | 45 × 40                           | 320   | 340                                       | 5.1   | 2.9                                       | B43511E5477M0##                             |
| 560                             | 35 × 70                           | 270   | 290                                       | 6.5   | 3.6                                       | B435*1A5567M0##                             |
| 560                             | 40 × 60                           | 270   | 290                                       | 6.4   | 3.6                                       | B435*1C5567M0##                             |
| 680                             | 35 × 80                           | 230   | 240                                       | 7.5   | 4.2                                       | B435*1A5687M0##                             |
| 680                             | 40 × 60                           | 230   | 240                                       | 7.1   | 3.9                                       | B435*1C5687M0##                             |
| 680                             | 45 × 50                           | 230   | 240                                       | 6.6   | 3.7                                       | B43511E5687M0##                             |
| 820                             | 40 × 70                           | 190   | 200                                       | 8.2   | 4.6                                       | B435*1A5827M0##                             |
| 820                             | 45 × 60                           | 190   | 200                                       | 7.8   | 4.3                                       | B43511C5827M0##                             |
| 1000                            | 40 × 100                          | 160   | 160                                       | 10.5  | 5.8                                       | B435*1A5108M0##                             |
| 1000                            | 45 × 70                           | 160   | 160                                       | 9.1   | 5.1                                       | B43511C5108M0##                             |
| 1500                            | 45 × 100                          | 110   | 110                                       | 12.9  | 7.1                                       | B43511A5158M0##                             |

Capacitors with solder pins are only available in 35 and 40 mm case diameters.

**Composition of ordering code**

\* = Terminal type

- 1 = 4-pin snap-in terminals
- 2 = solder pin

## = Terminal style and insulation feature

- 00 = solder pin or 4-pin snap-in standard terminals and PVC insulation
- 07 = 4-pin snap-in short terminals and PVC insulation
- 80 = 4-pin snap-in standard terminals and PVC insulation with additional PET insulation cap on terminal side
- 87 = 4-pin snap-in short terminals and PVC insulation with additional PET insulation cap on terminal side



**B43511, B43521**

**Outstanding ripple current – 85 °C**

**Useful life<sup>1)</sup>**

depending on ambient temperature  $T_A$  under ripple current operating conditions  
Voltage derating ( $0.95 \cdot V_R$ ) enables 105 °C operation

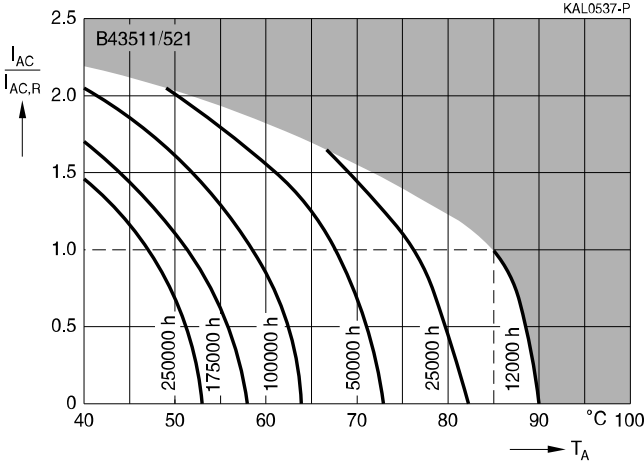

**Frequency factor of permissible ripple current  $I_{AC}$  versus frequency  $f$**

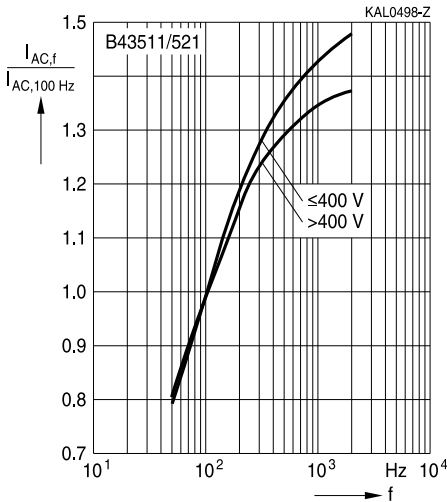

**Frequency characteristics of ESR**  
Typical behavior

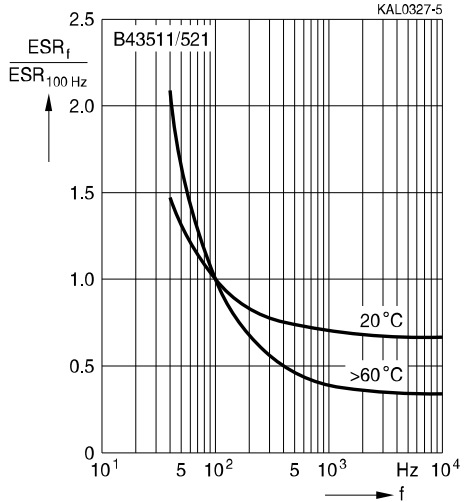

1) Refer to chapter "General technical information, 5 Useful life" on how to interpret useful life.



### Impedance Z versus frequency f

Typical behavior at 20 °C





**B43511, B43521**

**Outstanding ripple current – 85 °C**

## Cautions and warnings

### Personal safety

The electrolytes used by EPCOS have been optimized both with a view to the intended application and with regard to health and environmental compatibility. They do not contain any solvents that are detrimental to health, e.g. dimethyl formamide (DMF) or dimethyl acetamide (DMAC).

Furthermore, some of the high-voltage electrolytes used by EPCOS are self-extinguishing.

As far as possible, EPCOS does not use any dangerous chemicals or compounds to produce operating electrolytes. However, in exceptional cases, such materials must be used in order to achieve specific physical and electrical properties because no alternative materials are currently known. However, the amount of dangerous materials used in our products is limited to an absolute minimum.

Materials and chemicals used in EPCOS aluminum electrolytic capacitors are continuously adapted in compliance with the EPCOS Corporate Environmental Policy and the latest EU regulations and guidelines such as RoHS, REACH/SVHC, GADSL, and ELV.

MDS (Material Data Sheets) are available on the EPCOS website for all types listed in the data book. MDS for customer specific capacitors are available upon request.

MSDS (Material Safety Data Sheets) are available for all of our electrolytes upon request.

Nevertheless, the following rules should be observed when handling aluminum electrolytic capacitors: No electrolyte should come into contact with eyes or skin. If electrolyte does come into contact with the skin, wash the affected areas immediately with running water. If the eyes are affected, rinse them for 10 minutes with plenty of water. If symptoms persist, seek medical treatment. Avoid inhaling electrolyte vapor or mists. Workplaces and other affected areas should be well ventilated. Clothing that has been contaminated by electrolyte must be changed and rinsed in water.



## Product safety

The table below summarizes the safety instructions that must be observed without fail. A detailed description can be found in the relevant sections of chapter "General technical information".

| Topic  | Safety information  | Reference chapter "General technical information"                |
|--|---|--|
| Polarity                                       | Make sure that polar capacitors are connected with the right polarity.  | 1<br>"Basic construction of aluminum electrolytic capacitors"    |
| Reverse voltage                                | Voltages polarity classes should be prevented by connecting a diode.  | 3.1.6<br>"Reverse voltage"                                       |
| Mounting position of screw-terminal capacitors | Do not mount the capacitor with the terminals (safety vent) upside down.  | 11.1.<br>"Mounting positions of capacitors with screw terminals" |
| Robustness of terminals                        | The following maximum tightening torques must not be exceeded when connecting screw terminals:<br>M5: 2.5 Nm<br>M6: 4.0 Nm  | 11.3<br>"Mounting torques"                                       |
| Mounting of single-ended capacitors            | The internal structure of single-ended capacitors might be damaged if excessive force is applied to the lead wires.<br>Avoid any compressive, tensile or flexural stress.<br>Do not move the capacitor after soldering to PC board.<br>Do not pick up the PC board by the soldered capacitor.<br>Do not insert the capacitor on the PC board with a hole space different to the lead space specified. | 11.4<br>"Mounting considerations for single-ended capacitors"    |
| Soldering                                      | Do not exceed the specified time or temperature limits during soldering.  | 11.5<br>"Soldering"  |
| Soldering, cleaning agents                     | Do not allow halogenated hydrocarbons to come into contact with aluminum electrolytic capacitors.   | 11.6<br>"Cleaning agents"  |
| Upper category temperature                     | Do not exceed the upper category temperature.   | 7.2<br>"Maximum permissible operating temperature"               |
| Passive flammability                           | Avoid external energy, such as fire or electricity.   | 8.1<br>"Passive flammability"                                    |



**B43511, B43521**

**Outstanding ripple current – 85 °C**

| Topic                                    | Safety information  | Reference chapter "General technical information"   |
|--|---|---|
| Active flammability                      | Avoid overload of the capacitors.   | 8.2<br>"Active flammability"                        |
| Maintenance                              | Make periodic inspections of the capacitors.<br>Before the inspection, make sure that the power supply is turned off and carefully discharge the electricity of the capacitors.<br>Do not apply any mechanical stress to the capacitor terminals. | 10<br>"Maintenance"                                 |
| Storage                                  | Do not store capacitors at high temperatures or high humidity. Capacitors should be stored at +5 to +35 °C and a relative humidity of $\leq 75\%$ .   | 7.3<br>Storage conditions                           |
|  |   | Reference chapter "Capacitors with screw terminals" |
| Breakdown strength of insulating sleeves | Do not damage the insulating sleeve, especially when ring clips are used for mounting.  | "Screw terminals – accessories"                     |



**Symbols and terms**

| Symbol         | English   | German  |
|----------------|---|---|
| C              | Capacitance   | Kapazität   |
| $C_R$          | Rated capacitance   | Nennkapazität   |
| $C_S$          | Series capacitance  | Serienkapazität   |
| $C_{S,T}$      | Series capacitance at temperature T                       | Serienkapazität bei Temperatur T                          |
| $C_f$          | Capacitance at frequency f                                | Kapazität bei Frequenz f                                  |
| d              | Case diameter, nominal dimension                          | Gehäusedurchmesser, Nennmaß                               |
| $d_{max}$      | Maximum case diameter                                     | Maximaler Gehäusedurchmesser                              |
| ESL            | Self-inductance   | Eigeninduktivität   |
| ESR            | Equivalent series resistance                              | Ersatzserienwiderstand                                    |
| $ESR_f$        | Equivalent series resistance at frequency f               | Ersatzserienwiderstand bei Frequenz f                     |
| $ESR_T$        | Equivalent series resistance at temperature T             | Ersatzserienwiderstand bei Temperatur T                   |
| f              | Frequency   | Frequenz  |
| I              | Current   | Strom   |
| $I_{AC}$       | Alternating current (ripple current)                      | Wechselstrom  |
| $I_{AC,rms}$   | Root-mean-square value of alternating current             | Wechselstrom, Effektivwert                                |
| $I_{AC,f}$     | Ripple current at frequency f                             | Wechselstrom bei Frequenz f                               |
| $I_{AC,max}$   | Maximum permissible ripple current                        | Maximal zulässiger Wechselstrom                           |
| $I_{AC,R}$     | Rated ripple current                                      | Nennwechselstrom  |
| $I_{AC,R} (B)$ | Rated ripple current for base cooling                     | Nennwechselstromstrom für Bodenkühlung                    |
| $I_{leak}$     | Leakage current   | Reststrom   |
| $I_{leak,op}$  | Operating leakage current                                 | Betriebsreststrom   |
| l              | Case length, nominal dimension                            | Gehäuselänge, Nennmaß                                     |
| $l_{max}$      | Maximum case length (without terminals and mounting stud) | Maximale Gehäuselänge (ohne Anschlüsse und Gewindebolzen) |
| R              | Resistance  | Widerstand  |
| $R_{ins}$      | Insulation resistance                                     | Isolationswiderstand                                      |
| $R_{symm}$     | Balancing resistance                                      | Symmetrierwiderstand                                      |
| T              | Temperature   | Temperatur  |
| $\Delta T$     | Temperature difference                                    | Temperaturdifferenz                                       |
| $T_A$          | Ambient temperature                                       | Umgebungstemperatur                                       |
| $T_C$          | Case temperature  | Gehäusetemperatur   |
| $T_B$          | Capacitor base temperature                                | Temperatur des Becherbodens                               |
| t              | Time  | Zeit  |
| $\Delta t$     | Period  | Zeitraum  |
| $t_b$          | Service life (operating hours)                            | Brauchbarkeitsdauer (Betriebszeit)                        |



B43511, B43521

Outstanding ripple current – 85 °C

| Symbol          | English                                 | German                               |
|-----------------|---|--------------------------------------|
| V               | Voltage                                 | Spannung                             |
| V <sub>F</sub>  | Forming voltage                         | Formierspannung                      |
| V <sub>op</sub> | Operating voltage                       | Betriebsspannung                     |
| V <sub>R</sub>  | Rated voltage, DC voltage               | Nennspannung, Gleichspannung         |
| V <sub>S</sub>  | Surge voltage                           | Spitzenspannung                      |
| X <sub>C</sub>  | Capacitive reactance                    | Kapazitiver Blindwiderstand          |
| X <sub>L</sub>  | Inductive reactance                     | Induktiver Blindwiderstand           |
| Z               | Impedance                               | Scheinwiderstand                     |
| Z <sub>T</sub>  | Impedance at temperature T              | Scheinwiderstand bei Temperatur T    |
| tan δ           | Dissipation factor                      | Verlustfaktor                        |
| λ               | Failure rate                            | Ausfallrate                          |
| ε <sub>0</sub>  | Absolute permittivity                   | Elektrische Feldkonstante            |
| ε <sub>r</sub>  | Relative permittivity                   | Dielektrizitätszahl                  |
| ω               | Angular velocity; $2 \cdot \pi \cdot f$ | Kreisfrequenz; $2 \cdot \pi \cdot f$ |

**Note**

All dimensions are given in mm.

## Important notes

The following applies to all products named in this publication:

1. Some parts of this publication contain **statements about the suitability of our products for certain areas of application**. These statements are based on our knowledge of typical requirements that are often placed on our products in the areas of application concerned. We nevertheless expressly point out **that such statements cannot be regarded as binding statements about the suitability of our products for a particular customer application**. As a rule, EPCOS is either unfamiliar with individual customer applications or less familiar with them than the customers themselves. For these reasons, it is always ultimately incumbent on the customer to check and decide whether an EPCOS product with the properties described in the product specification is suitable for use in a particular customer application.
2. We also point out that **in individual cases, a malfunction of electronic components or failure before the end of their usual service life cannot be completely ruled out in the current state of the art, even if they are operated as specified**. In customer applications requiring a very high level of operational safety and especially in customer applications in which the malfunction or failure of an electronic component could endanger human life or health (e.g. in accident prevention or lifesaving systems), it must therefore be ensured by means of suitable design of the customer application or other action taken by the customer (e.g. installation of protective circuitry or redundancy) that no injury or damage is sustained by third parties in the event of malfunction or failure of an electronic component.
3. **The warnings, cautions and product-specific notes must be observed.**
4. In order to satisfy certain technical requirements, **some of the products described in this publication may contain substances subject to restrictions in certain jurisdictions (e.g. because they are classed as hazardous)**. Useful information on this will be found in our Material Data Sheets on the Internet ([www.epcos.com/material](http://www.epcos.com/material)). Should you have any more detailed questions, please contact our sales offices.
5. We constantly strive to improve our products. Consequently, **the products described in this publication may change from time to time**. The same is true of the corresponding product specifications. Please check therefore to what extent product descriptions and specifications contained in this publication are still applicable before or when you place an order. We also **reserve the right to discontinue production and delivery of products**. Consequently, we cannot guarantee that all products named in this publication will always be available. The aforementioned does not apply in the case of individual agreements deviating from the foregoing for customer-specific products.
6. Unless otherwise agreed in individual contracts, **all orders are subject to the current version of the "General Terms of Delivery for Products and Services in the Electrical Industry" published by the German Electrical and Electronics Industry Association (ZVEI)**.
7. The trade names EPCOS, BAOKE, Alu-X, CeraDiode, CeraLink, CSMP, CSSP, CTVS, DeltaCap, DigiSiMic, DSSP, FilterCap, FormFit, MiniBlue, MiniCell, MKD, MKK, MLSC, MotorCap, PCC, PhaseCap, PhaseCube, PhaseMod, PhiCap, SIFERRIT, SIFI, SIKOREL, SilverCap, SIMDAD, SiMic, SIMID, SineFormer, SIOV, SIP5D, SIP5K, ThermoFuse, WindCap are **trademarks registered or pending** in Europe and in other countries. Further information will be found on the Internet at [www.epcos.com/trademarks](http://www.epcos.com/trademarks).

Компания «Океан Электроники» предлагает заключение долгосрочных отношений при поставках импортных электронных компонентов на взаимовыгодных условиях!

Наши преимущества:

- Поставка оригинальных импортных электронных компонентов напрямую с производств Америки, Европы и Азии, а так же с крупнейших складов мира;
- Широкая линейка поставок активных и пассивных импортных электронных компонентов (более 30 млн. наименований);
- Поставка сложных, дефицитных, либо снятых с производства позиций;
- Оперативные сроки поставки под заказ (от 5 рабочих дней);
- Экспресс доставка в любую точку России;
- Помощь Конструкторского Отдела и консультации квалифицированных инженеров;
- Техническая поддержка проекта, помощь в подборе аналогов, поставка прототипов;
- Поставка электронных компонентов под контролем ВП;
- Система менеджмента качества сертифицирована по Международному стандарту ISO 9001;
- При необходимости вся продукция военного и аэрокосмического назначения проходит испытания и сертификацию в лаборатории (по согласованию с заказчиком);
- Поставка специализированных компонентов военного и аэрокосмического уровня качества (Xilinx, Altera, Analog Devices, Intersil, Interpoint, Microsemi, Actel, Aeroflex, Peregrine, VPT, Syfer, Eurofarad, Texas Instruments, MS Kennedy, Miteq, Cobham, E2V, MA-COM, Hittite, Mini-Circuits, General Dynamics и др.);

Компания «Океан Электроники» является официальным дистрибьютором и эксклюзивным представителем в России одного из крупнейших производителей разъемов военного и аэрокосмического назначения «JONHON», а так же официальным дистрибьютором и эксклюзивным представителем в России производителя высокотехнологичных и надежных решений для передачи СВЧ сигналов «FORSTAR».



## JONHON

«JONHON» (основан в 1970 г.)

Разъемы специального, военного и аэрокосмического назначения:

(Применяются в военной, авиационной, аэрокосмической, морской, железнодорожной, горно- и нефтедобывающей отраслях промышленности)

«FORSTAR» (основан в 1998 г.)

ВЧ соединители, коаксиальные кабели, кабельные сборки и микроволновые компоненты:

(Применяются в телекоммуникациях гражданского и специального назначения, в средствах связи, РЛС, а так же военной, авиационной и аэрокосмической отраслях промышленности).



Телефон: 8 (812) 309-75-97 (многоканальный)

Факс: 8 (812) 320-03-32

Электронная почта: [ocean@oceanchips.ru](mailto:ocean@oceanchips.ru)

Web: <http://oceanchips.ru/>

Адрес: 198099, г. Санкт-Петербург, ул. Калинина, д. 2, корп. 4, лит. А