

# Power Entry Modules

*The industry's most complete line of power entry modules are ideal for products that must conform to FCC Part 15 regulations. These metal cased miniature filters offer high performance.*



Bolt-in Rear Terminals .....	PF16-PF17
For General Purpose Applications .....	PF22-PF23
For Medical Applications .....	PF24-PF25
Bolt-in Right Angle Terminals .....	PF18-PF19
For PCB Applications .....	PF46-PF47
High Frequency Attenuation .....	PF20-PF21
Bolt-in for PCB Applications .....	PF48-PF49
Snap-in with Wire Leads .....	PF26-PF27
Bolt-in with Wire Leads .....	PF28-PF31
Snap-in Mount .....	PF32-PF33
Fused Filtered .....	PF34-PF37
For General Purpose Applications .....	PF34-PF35
For Medical or General Purpose Applications .....	PF36-PF37
Switched and Fused Filtered .....	PF38-PF43
PCB Power Filters .....	PF44-PF45

# Power Entry Modules Bolt-in Rear Terminals

## 60-BPR & BPS Series

### Features

- Ideally suited for products that must conform to FCC part 15 regulations
- Metal case offers high performance
- Meets over voltage of IEC 664 category II and complies with IEC 950
- Uses IEC connector that meets most safety standards
- Solder lug and Fast-on tab terminals available
- Operating temperature: -25°C to +85°C (including temperature rise, see graph on page PF17)
- UL approved low leakage version also available

### Applications

- Digital equipment
- Personal computers and peripherals
- Measuring instruments
- Monitor and display units



Tested and found to be IAW VDE 0565 Part 3.



### Circuit Diagram



### Specifications

Model*	Rated Voltage (@ 50/60Hz)	Rated Current	Leakage Current (Max.)	Capacitance		Inductance (L <sub>1</sub> )	Temperature Rise (Max.)
				C <sub>Y</sub>	C <sub>X</sub>		
60-XXX-010-3-2	250VAC	1A	0.35mA	2200pF ± 20%	.022uF ± 20%	6.0mH	30°C
60-XXX-010-3-4					.047uF ± 20%		
60-XXX-010-5-2			0.50mA	3300pF ± 20%	.022uF ± 20%		
60-XXX-010-5-4					.047uF ± 20%		
60-XXX-020-3-2	250VAC	2A	0.35mA	2200pF ± 20%	.022uF ± 20%	2.4mH	30°C
60-XXX-020-3-4					.047uF ± 20%		
60-XXX-020-5-2			0.50mA	3300pF ± 20%	.022uF ± 20%		
60-XXX-020-5-4					.047uF ± 20%		
60-XXX-030-3-2	250VAC	3A	0.35mA	2200pF ± 20%	.022uF ± 20%	1.2mH	30°C
60-XXX-030-3-4					.047uF ± 20%		
60-XXX-030-5-2			0.50mA	3300pF ± 20%	.022uF ± 20%		
60-XXX-030-5-4					.047uF ± 20%		
60-XXX-060-3-2	250VAC	6A	0.35mA	2200pF ± 20%	.022uF ± 20%	0.53mH	45°C
60-XXX-060-3-4					.047uF ± 20%		
60-XXX-060-5-2			0.50mA	3300pF ± 20%	.022uF ± 20%		
60-XXX-060-5-4					.047uF ± 20%		
60-XXX-100-3-2	250VAC	10A	0.35mA	2200pF ± 20%	.022uF ± 20%	0.26mH	45°C
60-XXX-100-5-2			0.50mA	3300pF ± 20%	.022uF ± 20%		
60-BPR-150-3-11	250VAC	15A	0.35mA	2200pF ± 20%	.1uF ± 20%	0.15mH	45°C

Note: Test voltage: 1500VAC one minute, line to ground  
 Insulation resistance: 300 Mohm min. at 500VDC  
 Voltage drop: 1V max. at rated current  
 Weight: 45g  
 Input: Compatible with IEC-320

\* Substitute BPR or BPS for XXX

BPS - Solder lug terminals  
 BPR - Fast-on tab terminals

# Power Entry Modules Bolt-in Rear Terminals

## 60-BPR & BPS Series



# Power Entry Modules Bolt-in Right Angle Terminals



## 60-BPF Series

### Features

- Ideally suited for products that must conform to FCC part 15 regulations
- Metal case offers high performance
- Meets over voltage of IEC 664 category II and complies with IEC 950
- Uses IEC connector that meets most safety standards
- PCB mounting types available (see page PF46)
- Length under tab is shortened for small spaces
- Operating temperature: -25°C to +85°C (including temperature rise, see graph on page PF19)
- UL approved low leakage version also available



Tested and found to be IAW VDE 0565 Part 3.

### Applications

- Digital equipment
- Personal computers and peripherals
- Measuring instruments
- Monitor and display units

### Circuit Diagram



### Specifications

Model	Rated Voltage (@ 50/60Hz)	Rated Current	Leakage Current (Max.)	Capacitance		Inductance (L <sub>1</sub> )	Temperature Rise (Max.)
				C <sub>Y</sub>	C <sub>X</sub>		
60-BPF-010-3-2	250VAC	1A	0.35mA	2200pF ± 20%	.022uF ± 20%	6.0mH	30°C
60-BPF-010-3-4					.047uF ± 20%		
60-BPF-010-5-2			0.50mA	3300pF ± 20%	.022uF ± 20%		
60-BPF-010-5-4					.047uF ± 20%		
60-BPF-020-3-2	250VAC	2A	0.35mA	2200pF ± 20%	.022uF ± 20%	2.4mH	30°C
60-BPF-020-3-4					.047uF ± 20%		
60-BPF-020-5-2			0.50mA	3300pF ± 20%	.022uF ± 20%		
60-BPF-020-5-4					.047uF ± 20%		
60-BPF-030-3-2	250VAC	3A	0.35mA	2200pF ± 20%	.022uF ± 20%	1.2mH	30°C
60-BPF-030-3-4					.047uF ± 20%		
60-BPF-030-5-2			0.50mA	3300pF ± 20%	.022uF ± 20%		
60-BPF-030-5-4					.047uF ± 20%		
60-BPF-060-3-2	250VAC	6A	0.35mA	2200pF ± 20%	.022uF ± 20%	0.53mH	45°C
60-BPF-060-3-4					.047uF ± 20%		
60-BPF-060-5-2			0.50mA	3300pF ± 20%	.022uF ± 20%		
60-BPF-060-5-4					.047uF ± 20%		

Note: Test voltage: 1500VAC one minute, line to ground  
 Insulation resistance: 300 Mohm min. at 500VDC  
 Voltage drop: 1V max. at rated current  
 Weight: 50g  
 Input: Compatible with IEC-320

# Power Entry Modules Bolt-in Right Angle Terminals

## 60-BPF Series

### Temperature Characteristics



### 60-BPF Fast-on Terminals



Dimensions in inches (mm)

### Common Mode



#### 60-BPF-010;-020



#### 60-BPF-030;-060

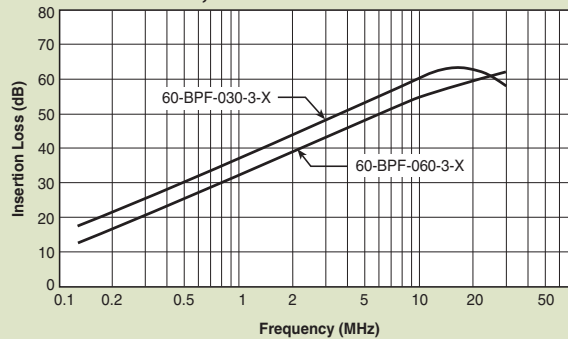

### Normal Mode



#### 60-BPF-010;-020



#### 60-BPF-030;-060

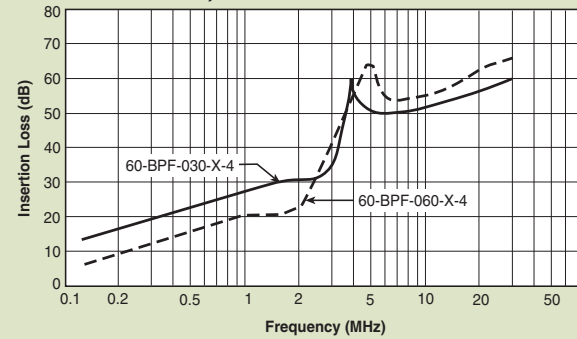

# Power Entry Modules High Frequency Attenuation



## 60-BHS Series



Tested and found to be  
IAW VDE 0565 Part 3.

### Features

- Ideally suited for products that must conform to FCC part 15 regulations
- Metal cased miniature filter offers high performance
- Meets over voltage of IEC 664 category II and complies with IEC 950
- PCB mounting types available (see page PF48)
- PCB mounting minimizes space and provides economical installation
- Excellent filtering characteristics for high frequencies
- Earth coil standard
- Operating temperature: -25°C to +85°C (including temperature rise, see graph on page PF21)

### Applications

- Digital equipment
- Personal computers and peripherals
- Measuring instruments
- Monitor and display units

### Circuit Diagram



### Specifications

Model	Rated Voltage (@ 50/60Hz)	Rated Current	Leakage Current (Max.)	Capacitance		Inductance (L <sub>1</sub> ) (L <sub>2</sub> )		Temperature Rise (Max.)
				C <sub>Y</sub>	C <sub>X</sub>	(L <sub>1</sub> )	(L <sub>2</sub> )	
60-BHS-010-3-11	250VAC	1A	0.35mA	2200pF ± 20%	0.1uF ± 20%	6mH	18.3uH	30°C
60-BHS-010-3-4					.047uF ± 20%			
60-BHS-010-5-11			0.50mA	3300pF ± 20%	0.1uF ± 20%			
60-BHS-010-5-4					.047uF ± 20%			
60-BHS-020-3-11	250VAC	2A	0.35mA	2200pF ± 20%	0.1uF ± 20%	2.4mH	18.3uH	30°C
60-BHS-020-3-4					.047uF ± 20%			
60-BHS-020-5-11			0.50mA	3300pF ± 20%	0.1uF ± 20%			
60-BHS-020-5-4					.047uF ± 20%			
60-BHS-030-3-11	250VAC	3A	0.35mA	2200pF ± 20%	0.1uF ± 20%	1.2mH	18.3uH	30°C
60-BHS-030-3-4					.047uF ± 20%			
60-BHS-030-5-11			0.50mA	3300pF ± 20%	0.1uF ± 20%			
60-BHS-030-5-4					.047uF ± 20%			
60-BHS-060-3-11	250VAC	6A	0.35mA	2200pF ± 20%	0.1uF ± 20%	.53mH	18.3uH	45°C
60-BHS-060-3-4					.047uF ± 20%			
60-BHS-060-5-11			0.50mA	3300pF ± 20%	0.1uF ± 20%			
60-BHS-060-5-4					.047uF ± 20%			

Note: Test voltage: 1500VAC one minute, line to ground  
 Insulation resistance: 300 Mohm min. at 500VDC  
 Voltage drop: 1V max. at rated current  
 Weight: 50g  
 Input: Compatible with IEC-320

# Power Entry Modules High Frequency Attenuation

## 60-BHS Series

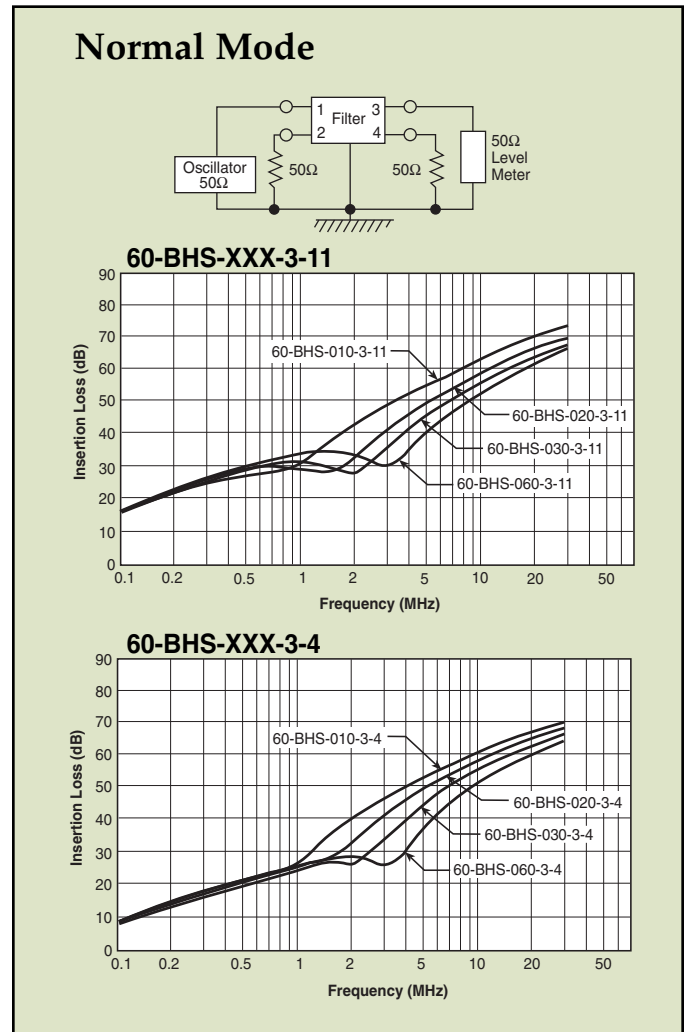

# Power Entry Modules Bolt-in Rear Terminals

For General Purpose Applications



## 10-BPF Series



### Features

- Ideally suited for products that must conform to FCC part 15 regulations
- Metal case offers high performance
- Meets over voltage of IEC 664 category II and complies with IEC 950
- Uses IEC connector that meets most safety standards
- Operating temperature: -25°C to +70°C
- Compact configuration

### Applications

- Digital equipment
- Personal computers and peripherals
- Measuring instruments
- Monitor and display units

### Circuit Diagram



### Specifications

Model	Rated Voltage (@ 50/60Hz)	Rated Current	Leakage Current (Max.)	Capacitance		Inductance (L <sub>1</sub> )	Circuit Diagram	Figure	Temperature Rise (Max.)
				C <sub>Y</sub>	C <sub>X</sub>				
10-BPF-001-5-A	120/250VAC	1A	0.50mA	3300pF	2200pF	3.0mH	1	A	30°C
10-BPF-001-5-C									
10-BPF-003-5-A		3A		4700pF	0.01uF	1.5mH	2	B	
10-BPF-003-5-C									
10-BPF-006-5-A		6A		3300pF	0.5mH	1	A		
10-BPF-006-5-C								C	
10-BPF-006-5-D		10A		3300pF & 0.01uF	3300pF & 0.01uF	1.5mH	2		
10-BPF-010-5-A								A	
10-BPF-010-5-D		3300pF & 0.01uF		3300pF & 0.01uF	1.5mH	3	B		

Note: Test voltage: 1500VAC one minute, line to ground  
 Insulation resistance: 300 Mohm min. at 500VDC  
 Voltage drop: 1V max. at rated current  
 Weight: 45g  
 Input: Compatible with IEC-320



# Power Entry Modules Bolt-in Rear Terminals For General Purpose Applications

## 10-BPF Series

**Figure A**



**Figure B**



**Figure C**



Dimensions in inches (mm)

### Common Mode



#### 10-BPF-001;-003



#### 10-BPF-006;-010



### Normal Mode



#### 10-BPF-001;-003



#### 10-BPF-006;-010



# Power Entry Modules Bolt-in Rear Terminals

For Medical Purpose Applications



## 10-BPF Series



### Features

- Ideally suited for products that must conform to FCC part 15 regulations
- Metal case offers high performance
- Meets over voltage of IEC 664 category II and complies with IEC 950
- Uses IEC connector that meets most safety standards
- Operating temperature: -25°C to +70°C
- Compact configuration
- Low leakage current

### Applications

- Digital equipment
- Personal computers and peripherals
- Measuring instruments
- Monitor and display units

### Circuit Diagram



### Specifications

Model	Rated Voltage (@ 50/60Hz)	Rated Current	Leakage Current (Max.)	Capacitance C <sub>x</sub>	Inductance (L <sub>1</sub> )	Circuit Diagram	Figure	Temperature Rise (Max.)
10-BPF-001-2-A	120/250VAC	1A	5uA	0.01uF	3.0mH	1	A	30°C
10-BPF-003-2-A		3A			1.5mH			
10-BPF-006-2-A		6A			0.5mH			

Note: Test voltage: 1500VAC one minute, line to ground  
 Insulation resistance: 300 Mohm min. at 500VDC  
 Voltage drop: 1V max. at rated current  
 Weight: 45g  
 Input: Compatible with IEC-320

# Power Entry Modules Bolt-in Rear Terminals For Medical Purpose Applications

## 10-BPF Series



Dimensions in inches (mm)



### Common Mode



#### 10-BPF-001;-003;-006



### Normal Mode



#### 10-BPF-001;-003;-006



# Power Entry Modules Snap-in with Wire Leads



## 60-SPL Series

### Features

- Ideally suited for products that must conform to FCC part 15 regulations
- Metal cased miniature filter offers high performance
- Meets over voltage of IEC 664 category II and complies with IEC 950
- Uses IEC connector that meets most safety standards
- Snap-in style saves labor and hardware inventory
- Wire output minimizes space and provides economical installation
- Operating temperature: -25°C to +85°C (including temperature rise, see graph on page PF27)



Tested and found to be IAW VDE 0565 Part 3.

### Applications

- Digital equipment
- Personal computers and peripherals
- Measuring instruments
- Monitor and display units

### Circuit Diagram



### Specifications

Model	Rated Voltage (@ 50/60Hz)	Rated Current	Leakage Current (Max.)	Capacitance		Inductance (L <sub>1</sub> )	Temperature Rise (Max.)	
				C <sub>Y</sub>	C <sub>X</sub>			
60-SPL-010-3-2	250VAC	1A	0.35mA	2200pF ± 20%	22nF ± 20%	6.0mH	30°C	
60-SPL-010-3-3					33nF ± 20%			
60-SPL-010-5-2			0.50mA	3300pF ± 20%	22nF ± 20%			
60-SPL-010-5-3					33nF ± 20%			
60-SPL-020-3-2	250VAC	2A	0.35mA	2200pF ± 20%	22nF ± 20%	2.4mH	30°C	
60-SPL-020-3-3					33nF ± 20%			
60-SPL-020-5-2			0.50mA	3300pF ± 20%	22nF ± 20%			
60-SPL-020-5-3					33nF ± 20%			
60-SPL-030-3-2	250VAC	3A	0.35mA	2200pF ± 20%	.022uF ± 20%	1.2mH	30°C	
60-SPL-030-3-3				3300pF ± 20%				
60-SPL-030-5-2			0.50mA	3300pF ± 20%	2200pF ± 20%			.033uF ± 20%
60-SPL-030-5-3					3300pF ± 20%			
60-SPL-060-3-2	250VAC	6A	0.35mA	2200pF ± 20%	22nF ± 20%	0.53mH	45°C	
60-SPL-060-3-3					33nF ± 20%			
60-SPL-060-5-2			0.50mA	3300pF ± 20%	22nF ± 20%			
60-SPL-060-5-3					33nF ± 20%			

Note: Test voltage: 1500VAC one minute, line to ground  
 Insulation resistance: 300 Mohm min. at 500VDC  
 Voltage drop: 1V max. at rated current  
 Weight: 50g  
 Input: Compatible with IEC-320

# Power Entry Modules Snap-in with Wire Leads

## 60-SPL Series



# Power Entry Modules Bolt-in with Wire Leads



## 60-BPL Series

### Features

- Ideally suited for products that must conform to FCC part 15 regulations
- Metal case filter offers high performance
- Meets over voltage of IEC 664 category II and complies with IEC 950
- Uses IEC connector that meets most safety standards
- Wire output for minimizing space use and economical installation
- Operating temperature: -25°C to +85°C (including temperature rise, see graph on page PF28)



Tested and found to be  
IAW VDE 0565 Part 3.

### Applications

- Digital equipment
- Personal computers and peripherals
- Measuring instruments
- Monitor and display units

### Circuit Diagram



### Specifications

Model	Rated Voltage (@ 50/60Hz)	Rated Current	Leakage Current (Max.)	Capacitance		Inductance (L <sub>1</sub> )	Temperature Rise (Max.)
				C <sub>Y</sub>	C <sub>X</sub>		
60-BPL-010-3-2	250VAC	1A	0.35mA	2200pF ± 20%	22nF ± 20%	6.0mH	30°C
60-BPL-010-3-3					33nF ± 20%		
60-BPL-010-5-2			0.50mA	3300pF ± 20%	22nF ± 20%		
60-BPL-010-5-3					33nF ± 20%		
60-BPL-020-3-2	250VAC	2A	0.35mA	2200pF ± 20%	22nF ± 20%	2.4mH	30°C
60-BPL-020-3-3					33nF ± 20%		
60-BPL-020-5-2			0.50mA	3300pF ± 20%	22nF ± 20%		
60-BPL-020-5-3					33nF ± 20%		
60-BPL-030-3-2	250VAC	3A	0.35mA	2200pF ± 20%	.022uF ± 20%	1.2mH	30°C
60-BPL-030-3-3				3300pF ± 20%			
60-BPL-030-5-2			0.50mA	2200pF ± 20%	.033uF ± 20%		
60-BPL-030-5-3							
60-BPL-060-3-2	250VAC	6A	0.35mA	2200pF ± 20%	22nF ± 20%	0.53mH	45°C
60-BPL-060-3-3					33nF ± 20%		
60-BPL-060-5-2			0.50mA	3300pF ± 20%	22nF ± 20%		
60-BPL-060-5-3					33nF ± 20%		

Note: Test voltage: 1500VAC one minute, line to ground  
 Insulation resistance: 300 Mohm min. at 500VDC  
 Voltage drop: 1V max. at rated current  
 Weight: 50g  
 Input: Compatible with IEC-320

# Power Entry Modules Bolt-in with Wire Leads

## 60-BPL Series



# Power Entry Modules Bolt-in with Wire Leads



## 10-BPL Series



### Features

- Ideally suited for products that must conform to FCC part 15 regulations
- Metal case filter offers high performance
- Meets over voltage of IEC 664 category II and complies with IEC 950
- Uses IEC connector that meets most safety standards
- Wire output for minimizing space use and economical installation
- Operating temperature: -25°C to +70°C
- Compact configuration

### Applications

- Digital equipment
- Personal computers and peripherals
- Measuring instruments
- Monitor and display units

### Circuit Diagram



### Specifications

Model	Rated Voltage (@ 50/60Hz)	Rated Current	Leakage Current (Max.)	Capacitance		Inductance (L <sub>1</sub> )	Circuit Diagram	Figure	Temperature Rise (Max.)
				C <sub>Y</sub>	C <sub>X</sub>				
10-BPL-001-5-B	250VAC	1A	0.50mA	3300pF	0.01uF	3.0mH	1	A	30°C
10-BPL-003-5-B		3A				1.5mH			
10-BPL-006-5-B		6A				0.5mH			

Note: Test voltage: 1500VAC one minute, line to ground  
 Insulation resistance: 300 Mohm min. at 500VDC  
 Voltage drop: 1V max. at rated current  
 Weight: 50g  
 Input: Compatible with IEC-320



# Power Entry Modules Bolt-in with Wire Leads

## 10-BPL Series

**Figure A**



# Power Entry Modules Snap-in Mount

## 60-SPR & SPS Series

### Features

- Ideally suited for products that must conform to FCC part 15 regulations
- Metal cased miniature filter offers high performance
- Meets over voltage of IEC 664 category II and complies with IEC 950
- Uses IEC connector that meets most safety standards
- Snap-in style saves labor and hardware inventory
- Solder lug and fast-on tab terminations available
- Operating temperature: -25°C to +85°C (including temperature rise, see graph on page PF33)
- UL approved low leakage version also available



Tested and found to be IAW VDE 0565 Part 3.



### Applications

- Digital equipment
- Personal computers and peripherals
- Measuring instruments
- Monitor and display units

### Specifications

### Circuit Diagram



Model*	Rated Voltage (@ 50/60Hz)	Rated Current	Leakage Current (Max.)	Capacitance		Inductance (L <sub>1</sub> )	Temperature Rise (Max.)
				C <sub>Y</sub>	C <sub>X</sub>		
60-XXX-010-3-2	250VAC	1A	0.35mA	2200pF ± 20%	.022uF ± 20%	6.0mH	30°C
60-XXX-010-3-4					.047uF ± 20%		
60-XXX-010-5-2			0.50mA	3300pF ± 20%	.022uF ± 20%		
60-XXX-010-5-4				.047uF ± 20%			
60-XXX-020-3-2	250VAC	2A	0.35mA	2200pF ± 20%	.022uF ± 20%	2.4mH	30°C
60-XXX-020-3-4					.047uF ± 20%		
60-XXX-020-5-2			0.50mA	3300pF ± 20%	.022uF ± 20%		
60-XXX-020-5-4				.047uF ± 20%			
60-XXX-030-3-2	250VAC	3A	0.35mA	2200pF ± 20%	.022uF ± 20%	1.2mH	30°C
60-XXX-030-3-4					.047uF ± 20%		
60-XXX-030-5-2			0.50mA	3300pF ± 20%	.022uF ± 20%		
60-XXX-030-5-4				.047uF ± 20%			
60-XXX-060-3-2	250VAC	6A	0.35mA	2200pF ± 20%	.022uF ± 20%	0.53mH	45°C
60-XXX-060-3-4					.047uF ± 20%		
60-XXX-060-5-2			0.50mA	3300pF ± 20%	.022uF ± 20%		
60-XXX-060-5-4				.047uF ± 20%			
60-XXX-100-3-2	250VAC	10A	0.35mA	2200pF ± 20%	.022uF ± 20%	0.26mH	45°C
60-XXX-100-5-2			0.50mA	3300pF ± 20%			
60-SPR-150-3-11	250VAC	15A	0.35mA	2200pF ± 20%	.1uF ± 20%	0.15mH	45°C

Note: Test voltage: 1500VAC one minute, line to ground  
 Insulation resistance: 300 Mohm min. at 500VDC  
 Voltage drop: 1V max. at rated current  
 Weight: 45g  
 Input: Compatible with IEC-320

\* Substitute SPR or SPS for XXX  
 60-SPR - Fast-on terminals  
 60-SPS - Solder lug terminals

# Power Entry Modules Snap-in Mount

## 60-SPR & SPS Series



# Fused Filtered Power Entry Modules

For General Purpose Applications

## 64-65-BFF/64-65-BFS Series



Tested and found to be IAW VDE 0565 Part 3.

### Features

- North American and Metric fuse holders available
- Fuse holder provides effective EMI suppression of common and differential mode
- Suitable for products that must conform to FCC and FTZ requirements
- Meets over voltage category II of IEC 664 and complies with IEC 950
- Fast-on terminals or solder lug terminals
- Metal case provides effective EMI shielding
- Operating temperature: -25°C to +85°C (including temperature rise, see graph on page PF35)

### Applications

- Computers and peripheral equipment
- Electronic equipment
- Digital equipment
- Measuring and testing instruments
- Telecommunications equipment



### Circuit Diagram

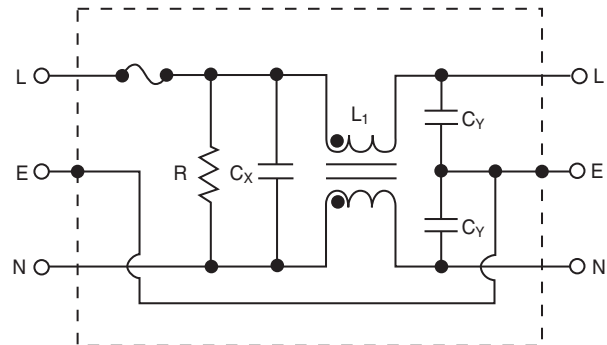

### Specifications

Model*	Rated Voltage (@ 50/60Hz)	Rated Current	Leakage Current (Max.)	Capacitance		Inductance (L <sub>1</sub> )	Temperature Rise (Max.)
				C <sub>Y</sub>	C <sub>X</sub>		
64-XXX-020-3-11	250VAC	2A	0.35mA	2200pF ± 20%	0.1uF	6.5mH	40°C
64-XXX-020-5-11			0.50mA	3300pF ± 20%			
64-XXX-020-3-12			0.35mA	2200pF ± 20%	0.22uF		
64-XXX-020-5-12			0.50mA	3300pF ± 20%			
64-XXX-040-3-11	250VAC	4A	0.35mA	2200pF ± 20%	0.1uF	4.2mH	45°C
64-XXX-040-5-11			0.50mA	3300pF ± 20%			
64-XXX-040-3-12			0.35mA	2200pF ± 20%	0.22uF		
64-XXX-040-5-12			0.50mA	3300pF ± 20%			
64-XXX-060-3-11	250VAC	6A	0.35mA	2200pF ± 20%	0.1uF	1.6mH	45°C
64-XXX-060-5-11			0.50mA	3300pF ± 20%			
64-XXX-060-3-12			0.35mA	2200pF ± 20%	0.22uF		
64-XXX-060-5-12			0.50mA	3300pF ± 20%			
65-XXX-020-3-11	125VAC	2A	0.20mA	2200pF ± 20%	0.1uF	6.5mH	40°C
65-XXX-020-5-11			0.25mA	3300pF ± 20%			
65-XXX-020-3-12			0.20mA	2200pF ± 20%	0.22uF		
65-XXX-020-5-12			0.25mA	3300pF ± 20%			
65-XXX-040-3-11	125VAC	4A	0.20mA	2200pF ± 20%	0.1uF	4.2mH	45°C
65-XXX-040-5-11			0.25mA	3300pF ± 20%			
65-XXX-040-3-12			0.20mA	2200pF ± 20%	0.22uF		
65-XXX-040-5-12			0.25mA	3300pF ± 20%			
65-XXX-060-3-11	125VAC	6A	0.20mA	2200pF ± 20%	0.1uF	1.6mH	45°C
65-XXX-060-5-11			0.25mA	3300pF ± 20%			
65-XXX-060-3-12			0.20mA	2200pF ± 20%	0.22uF		
65-XXX-060-5-12			0.25mA	3300pF ± 20%			

Note: Test Voltage 1500VAC one minute, line to ground  
Insulation Resistance: 300 MΩ min. at 500VDC  
F(S) = Fast-on or (Solder lug terminals)

Voltage Drop: 1V max. at rated current  
Weight: 78g  
Inlet: Compatible with IEC-320

\* Substitute BFF or BFS for XXX  
BFF - Fast-on terminals  
BFS - Solder lug terminals

# Fused Filtered Power Entry Modules

For General Purpose Applications

## 64-65-BFF/64-65-BFS Series

### Temperature Characteristics



### Dimensions 64/65-BFF Series



Dimensions in inches (mm)

### Common Mode



#### 0.50 mA Leakage Versions



#### 0.35 mA Leakage Versions



### Normal Mode



#### 0.50 mA Leakage Versions



#### 0.35 mA Leakage Versions



# Fused Filtered Power Entry Modules

For Medical or General Purpose Applications

## 66-67-BFF/66-67-BFS Series



Tested and found to be IAW VDE 0565 Part 3.

### Features

- Metric and North American fuse holders available
- Fuse holder provides effective EMI suppression of common and differential mode
- Suitable for products that must conform to FCC and FTZ requirements
- Meets over voltage category II of IEC 664 and complies with IEC 950
- Fast-on terminations or solder lug terminations
- Metal case provides effective EMI shielding
- Provides susceptibility protection without the leakage current associated with line-to-ground capacitance
- Reduces the line to ground capacitance in order to meet patient care requirements
- Operating temperature: -25°C to +85°C (including temperature rise, see graph on page PF37)



### Applications

- Medical equipment
- Electronic equipment
- Digital equipment
- Industrial equipment
- Telecommunications equipment
- Measuring and testing instruments
- Personal computers and peripherals

### Circuit Diagrams

66/67-BFF(S)-XXX-1-X Filter



66/67-BFF(S)-XXX-0-X and 66/67-BFF(S)-XXX-4-X Filters



### Specifications

Model*	Rated Voltage (@ 50/60Hz)	Rated Current	Leakage Current (Max.)	Capacitance		Inductance (L <sub>1</sub> )	Temperature Rise (Max.)	
				C <sub>v</sub>	C <sub>x</sub>			
66-XXX-020-1-11	250VAC	2A	0.01mA	none	330pF ± 20%	6.5mH	40°C	
66-XXX-020-1-12								0.1uF
66-XXX-020-0-11								0.22uF
66-XXX-020-4-11								0.075mA
66-XXX-020-0-12								0.1mA
66-XXX-020-4-12								0.075mA
66-XXX-040-1-11	250VAC	4A	0.01mA	none	330pF ± 20%	2.4mH	45°C	
66-XXX-040-1-12								0.1uF
66-XXX-040-0-11								0.22uF
66-XXX-040-4-11								0.075mA
66-XXX-040-0-12								0.1mA
66-XXX-040-4-12								0.075mA
66-XXX-060-1-11	250VAC	6A	0.01mA	none	330pF ± 20%	1.6mH	45°C	
66-XXX-060-1-12								0.1uF
66-XXX-060-0-11								0.22uF
66-XXX-060-4-11								0.075mA
66-XXX-060-0-12								0.1mA
66-XXX-060-4-12								0.075mA
67-XXX-020-1-11	125VAC	2A	0.005mA	none	330pF ± 20%	6.5mH	40°C	
67-XXX-020-1-12								0.1uF
67-XXX-020-0-11								0.22uF
67-XXX-020-4-11								0.035mA
67-XXX-020-0-12								0.05mA
67-XXX-020-4-12								0.035mA
67-XXX-040-1-11	125VAC	4A	0.005mA	none	330pF ± 20%	2.4mH	45°C	
67-XXX-040-1-12								0.1uF
67-XXX-040-0-11								0.22uF
67-XXX-040-4-11								0.035mA
67-XXX-040-0-12								0.05mA
67-XXX-040-4-12								0.035mA
67-XXX-060-1-11	125VAC	6A	0.005mA	none	330pF ± 20%	1.6mH	45°C	
67-XXX-060-1-12								0.1uF
67-XXX-060-0-11								0.22uF
67-XXX-060-4-11								0.035mA
67-XXX-060-0-12								0.05mA
67-XXX-060-4-12								0.035mA

Note: Test Voltage 1500VAC one minute, line to ground  
Insulation Resistance: 300 MΩ min. at 500VDC  
F(S) = Fast-on or (Solder lug terminals)

Voltage Drop: 1V max. at rated current  
Weight: 78g  
Inlet: Compatible with IEC-320

\* Substitute BFF or BFS for XXX  
BFF - Fast-on terminals  
BFS - Solder lug terminals

# Fused Filtered Power Entry Modules

For Medical or General Purpose Applications

## 66-67-BFF/66-67-BFS Series



### Dimensions

#### 66-67-BFF/66-67-BFS Series



# Switched and Fused Filtered Power Entry Modules For General Purpose Applications



## 64-65-BSF/64-65-SSF Series



Tested and found to be  
IAW VDE 0565 Part 3.

### Features

- North American and Metric fuse holders available
- Fuse holder and double pole power ON/OFF switch provided in a convenient/compact package
- Suitable for products that must conform to FCC and FTZ requirements
- Meets over voltage category II of IEC 664 and complies with IEC 950
- Metal case provides effective EMI shielding
- Easy access fuse drawer with space for spare fuse
- Flange-mounted or snap-in styles available for quick mounting
- Operating temperature: -25°C to +85°C (including temperature rise, see graph on page PF39)

### Applications

- Computers and peripheral equipment
- Digital equipment
- Electronic equipment
- Measuring and testing instruments
- Telecommunications equipment

### Circuit Diagram

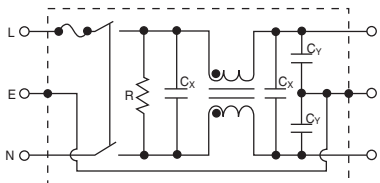

### Specifications

Model*	Rated Voltage (@ 50/60Hz)	Rated Current	Leakage Current (Max.)	Capacitance			Inductance (L <sub>1</sub> )	Temperature Rise (Max.)
				C <sub>Y</sub>	C <sub>X1</sub>	C <sub>X2</sub>		
64-XXX-020-3-12	250VAC	2A	0.35mA	2200pF	0.22uF	NONE	10.5mH	45°C
64-XXX-020-3-04						0.22uF		
64-XXX-020-3-14						NONE		
64-XXX-020-3-06						0.22uF		
64-XXX-020-5-12						NONE		
64-XXX-020-5-04						0.22uF		
64-XXX-020-5-14	250VAC	4A	0.50mA	3300pF	0.47uF	NONE	4.2mH	45°C
64-XXX-020-5-06						0.22uF		
64-XXX-040-3-12						NONE		
64-XXX-040-3-04						0.22uF		
64-XXX-040-3-14						NONE		
64-XXX-040-3-06						0.22uF		
64-XXX-040-5-12	250VAC	6A	0.35mA	2200pF	0.22uF	NONE	1.6mH	45°C
64-XXX-040-5-04						0.22uF		
64-XXX-040-5-14						NONE		
64-XXX-040-5-06						0.22uF		
64-XXX-060-3-12						NONE		
64-XXX-060-3-04						0.22uF		
64-XXX-060-3-14	125VAC	2A	0.20mA	2200pF	0.22uF	NONE	10.5mH	45°C
64-XXX-060-3-06						0.22uF		
64-XXX-060-5-12						NONE		
64-XXX-060-5-04						0.22uF		
64-XXX-060-5-14						NONE		
64-XXX-060-5-06						0.22uF		
64-XXX-060-5-14	125VAC	4A	0.25mA	3300pF	0.47uF	NONE	4.2mH	45°C
64-XXX-060-5-06						0.22uF		
64-XXX-040-3-12						NONE		
64-XXX-040-3-04						0.22uF		
64-XXX-040-3-14						NONE		
64-XXX-040-3-06						0.22uF		
64-XXX-040-5-12	125VAC	6A	0.20mA	2200pF	0.22uF	NONE	1.6mH	45°C
64-XXX-040-5-04						0.22uF		
64-XXX-040-5-14						NONE		
64-XXX-040-5-06						0.22uF		
64-XXX-060-3-12						NONE		
64-XXX-060-3-04						0.22uF		
64-XXX-060-3-14	125VAC	2A	0.25mA	3300pF	0.47uF	NONE	10.5mH	45°C
64-XXX-060-3-06						0.22uF		
64-XXX-060-5-12						NONE		
64-XXX-060-5-04						0.22uF		
64-XXX-060-5-14						NONE		
64-XXX-060-5-06						0.22uF		
64-XXX-060-5-14	125VAC	4A	0.25mA	3300pF	0.47uF	NONE	4.2mH	45°C
64-XXX-060-5-06						0.22uF		
64-XXX-040-3-12						NONE		
64-XXX-040-3-04						0.22uF		
64-XXX-040-3-14						NONE		
64-XXX-040-3-06						0.22uF		
64-XXX-040-5-12	125VAC	6A	0.20mA	2200pF	0.22uF	NONE	1.6mH	45°C
64-XXX-040-5-04						0.22uF		
64-XXX-040-5-14						NONE		
64-XXX-040-5-06						0.22uF		
64-XXX-060-3-12						NONE		
64-XXX-060-3-04						0.22uF		
64-XXX-060-3-14	125VAC	2A	0.25mA	3300pF	0.47uF	NONE	10.5mH	45°C
64-XXX-060-3-06						0.22uF		
64-XXX-060-5-12						NONE		
64-XXX-060-5-04						0.22uF		
64-XXX-060-5-14						NONE		
64-XXX-060-5-06						0.22uF		

Note: Test Voltage 1500VAC one minute, line to ground  
Insulation Resistance: 300 MΩ min. at 500VDC  
B(S) = Bolt-in terminals or (Snap-in terminals)

Voltage Drop: 1V max. at rated current  
Weight: 130g  
Inlet: Compatible with IEC-320

\* **Substitute BSF or SSF for XXX**  
BSF - Bolt-in switched and fused  
SSF - Snap-in switched and fused



# Switched and Fused Filtered Power Entry Modules

For General Purpose Applications

## Temperature Characteristics



## Dimensions

### 64/65-BSF Series



### 64/65-SSF Series



## Common Mode



### 0.35 mA Leakage Versions



### 0.50 mA Leakage Versions



## Normal Mode



### 64/65-B(S)SF-\*-02(04,06)



### 64/65-B(S)SF-\*-11(12,14)



# Switched and Fused Filtered Power Entry Modules

For Medical or General Purpose Applications

## 66-67-BSF/66-67-SSF Series



Tested and found to be IAW VDE 0565 Part 3

### Features

- Metric and North American fuse holders available
- Fuse holder and a double pole power ON/OFF switch provides a convenient/compact package
- Suitable for products that must conform to FCC and FTZ requirements
- Meets over voltage category II of IEC 664 and complies with IEC 950
- Provides susceptibility protection without the leakage current associated with line-to-ground capacitors
- Designed to meet requirements for non-patient and patient care equipment
- Metal case provides effective EMI shielding
- Easy access fuse drawer - space for spare fuse
- Flange-mounted or snap-in styles available for quick mounting
- Operating temperature: -25°C to +85°C (including temperature rise, see graph on page PF41)

### Specifications

Model*	Rated Voltage 50/60Hz	Rated Current	Leakage Current (Max.)	Capacitance			Temp. Induct. (L <sub>1</sub> )	Rise (Max.)				
				C <sub>Y</sub>	C <sub>X1</sub>	C <sub>X2</sub>						
66-XXX-020-0-12	250 VAC	2A	.075mA	330pF	0.22uF	NONE	10.5mH	40°C				
66-XXX-020-0-04					0.22uF	NONE						
66-XXX-020-0-14					0.47uF	NONE						
66-XXX-020-0-06					0.22uF	NONE						
66-XXX-020-1-12					0.22uF	NONE						
66-XXX-020-1-04					0.22uF	NONE						
66-XXX-020-1-14			.01mA	NONE	NONE	0.22uF			NONE			
66-XXX-020-1-06						0.47uF			NONE			
66-XXX-020-1-06						0.22uF			NONE			
66-XXX-020-4-12						0.1mA			470pF	470pF	0.22uF	NONE
66-XXX-020-4-04											0.22uF	NONE
66-XXX-020-4-14											0.47uF	NONE
66-XXX-020-4-06		0.22uF	NONE									
66-XXX-040-0-12		4A	.075mA	330pF	0.22uF		NONE	4.2mH			45°C	
66-XXX-040-0-04					0.22uF		NONE					
66-XXX-040-0-14					0.47uF	NONE						
66-XXX-040-0-06					0.22uF	NONE						
66-XXX-040-1-12					0.22uF	NONE						
66-XXX-040-1-04					0.22uF	NONE						
66-XXX-040-1-14			.01mA	NONE	NONE	0.47uF	NONE					
66-XXX-040-1-06						0.22uF	NONE					
66-XXX-040-1-06						.01mA	470pF		470pF	0.22uF		NONE
66-XXX-040-4-12										0.22uF		NONE
66-XXX-040-4-04										0.22uF		NONE
66-XXX-040-4-14	0.47uF									NONE		
66-XXX-040-4-06	0.22uF	NONE										
66-XXX-060-0-12	6A	.075mA	330pF	0.22uF	NONE			1.6mH		45°C		
66-XXX-060-0-04				0.22uF	NONE							
66-XXX-060-0-14				0.47uF	NONE							
66-XXX-060-0-06				0.22uF	NONE							
66-XXX-060-1-12				0.22uF	NONE							
66-XXX-060-1-04				0.22uF	NONE							
66-XXX-060-1-14		.01mA	NONE	NONE	0.47uF	NONE						
66-XXX-060-1-06					0.22uF	NONE						
66-XXX-060-1-06					.01mA	470pF	470pF		0.22uF		NONE	
66-XXX-060-4-12									0.22uF		NONE	
66-XXX-060-4-04									0.22uF		NONE	
66-XXX-060-4-14									0.47uF		NONE	
66-XXX-060-4-06	0.22uF	NONE										

Note: Test Voltage: 1500VAC one minute, line to ground  
Insulation Resistance: 300 MΩ min. at 500VDC  
Voltage Drop: 1V max. at rated current

Weight: 130g  
Inlet: Compatible with IEC-320  
B(S) = Bolt-in terminals or (Snap-in terminals)

\* Substitute BSF or SSF for XXX  
BSF - Bolt-In Switched and Fused  
SSF - Snap-In Switched and Fused



### Applications

- Medical equipment
- Industrial equipment
- Telecommunications equipment
- Measuring and testing instruments
- Digital equipment (including switching power supplies)
- General purpose filter for susceptibility or high frequency "clean up" applications

### Circuit Diagram

Note: C<sub>Y1</sub> and C<sub>Y2</sub> capacitors omitted on 66/67 B(S)F-XXX-1-X Filters

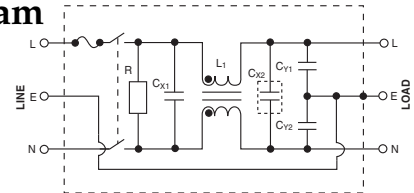

Model*	Rated Voltage 50/60Hz	Rated Current	Leakage Current (Max.)	Capacitance			Temp. Induct. (L <sub>1</sub> )	Rise (Max.)				
				C <sub>Y</sub>	C <sub>X1</sub>	C <sub>X2</sub>						
67-XXX-020-0-12	250 VAC	2A	0.04mA	330pF	0.22uF	NONE	10.5mH	40°C				
67-XXX-020-0-04					0.22uF	NONE						
67-XXX-020-0-14					0.47uF	NONE						
67-XXX-020-0-06					0.22uF	NONE						
67-XXX-020-1-12					0.22uF	NONE						
67-XXX-020-1-04					0.22uF	NONE						
67-XXX-020-1-14			.005mA	NONE	NONE	0.47uF			NONE			
67-XXX-020-1-06						0.22uF			NONE			
67-XXX-020-1-06						0.05mA			470pF	470pF	0.22uF	NONE
67-XXX-020-4-12											0.22uF	NONE
67-XXX-020-4-04											0.22uF	NONE
67-XXX-020-4-14											0.47uF	NONE
67-XXX-020-4-06		0.22uF	NONE									
67-XXX-040-0-12		125 VAC	4A	0.04mA	330pF		0.22uF	NONE			4.2mH	45°C
67-XXX-040-0-04						0.22uF	NONE					
67-XXX-040-0-14						0.47uF	NONE					
67-XXX-040-0-06						0.22uF	NONE					
67-XXX-040-1-12						0.22uF	NONE					
67-XXX-040-1-04						0.22uF	NONE					
67-XXX-040-1-14			.005mA	NONE	NONE	0.47uF	NONE					
67-XXX-040-1-06						0.22uF	NONE					
67-XXX-040-1-06						0.05mA	470pF	470pF	0.22uF	NONE		
67-XXX-040-4-12									0.22uF	NONE		
67-XXX-040-4-04									0.22uF	NONE		
67-XXX-040-4-14	0.47uF								NONE			
67-XXX-040-4-06	0.22uF	NONE										
67-XXX-060-0-12	6A	.005mA	NONE	NONE	0.22uF				NONE	1.6mH	45°C	
67-XXX-060-0-04					0.22uF	NONE						
67-XXX-060-0-14					0.47uF	NONE						
67-XXX-060-0-06					0.22uF	NONE						
67-XXX-060-1-12					0.22uF	NONE						
67-XXX-060-1-04					0.22uF	NONE						
67-XXX-060-1-14		.005mA	NONE	NONE	0.47uF	NONE						
67-XXX-060-1-06					0.22uF	NONE						
67-XXX-060-1-06					0.05mA	470pF	470pF	0.22uF	NONE			
67-XXX-060-4-12								0.22uF	NONE			
67-XXX-060-4-04								0.22uF	NONE			
67-XXX-060-4-14								0.47uF	NONE			
67-XXX-060-4-06	0.22uF	NONE										

# Switched and Fused Filtered Power Entry Modules

For Medical or General Purpose Applications

## Temperature Characteristics



## Dimensions 66/67-BSF Series



## 66/67-SSF Series



## Common Mode



### 0.01 mA Leakage Current



### 0.075 and 0.1 mA Leakage Current



## Normal Mode



### 0.01 mA Leakage Current



### 0.075 and 0.1 mA Leakage Current



# Switched and Fused Filtered Power Entry Modules

## Dual Fuse for European Applications



### 68-BSF Series

#### Features

- Dual fuse for European applications
- Fuse holder and double pole power ON/OFF switch provides a convenient/compact package
- Suitable for products that must conform to FCC and FTZ requirements
- Meets over voltage category II of IEC 664 and complies with IEC 950
- Metal case provides effective EMI shielding
- IEC connector meets the safety standards of most certifying agencies
- Easy access fuse drawer
- Flange-mounted
- UL, CSA, and SEMKO approved
- Designed to be in accordance with VDE 0565, part 3
- Operating temperature: -25°C to +85°C (including temperature rise, see graph on page PF43)

#### Applications

- Computers and peripheral equipment
- Electronic equipment
- Digital equipment
- Measuring and testing instruments
- Telecommunications equipment

#### Circuit Diagram



#### Specifications

Model	Rated Voltage (@ 50/60Hz)	Rated Current	Leakage Current (Max.)	Capacitance				Inductance (L <sub>1</sub> )	Temperature Rise (Max.)
				C <sub>Y1</sub>	C <sub>Y2</sub>	C <sub>X1</sub>	C <sub>X2</sub>		
68-BSF-020-3-01	250VAC	2A	0.35mA	2200pF	2200pF	0.1uF	0.1uF	10.5mH	45°C
68-BSF-020-3-04						0.22uF	0.22uF		
68-BSF-040-3-01		4A				0.1uF	0.1uF	4.2mH	
68-BSF-040-3-04						0.22uF	0.22uF		
68-BSF-060-3-01		6A				0.1uF	0.1uF	1.6mH	
68-BSF-060-3-04						0.22uF	0.22uF		

Note: Test Voltage 1500VAC one minute, line to ground  
 Insulation Resistance: 300 MΩ min. at 500VDC  
 Voltage Drop: 1V max. at rated current  
 Weight: 130g  
 Inlet: Compatible with IEC-320  
 B(S) = Bolt-in terminals

# Switched and Fused Filtered Power Entry Modules

## Dual Fuse for European Applications

### 68-BSF Series



# PCB Power Filters Miniature Printed Circuit Board

## 61-MPC Series



Tested and found to be  
IAW VDE 0565 Part 3

### Features

- Miniature general purpose PCB mounted filter
- Requires minimal PCB real estate space
- Low cost
- Designed for two wire cord systems
- For three wire cord systems, Y capacitors can be attached externally
- Operating temperature: -25°C to +85°C (including temperature rise, see graph on page PF45)

### Applications

- Personal computers and peripherals
- Digital equipment
- Measuring instruments and medical equipment
- TV & VCR monitors and display units
- Home appliances



### Circuit Diagram



## Specifications

Model	Rated Voltage (@ 50/60Hz)	Rated Current	Leakage Current (Max.)	Capacitance		Inductance (L <sub>1</sub> )	Temperature Rise (Max.)
				C <sub>X1</sub>	C <sub>X2</sub>		
61-MPC-010-1-11	250VAC	1A	0.1mA	0.1uF	0.1uF	11mH	40°C
61-MPC-016-1-11		1.6A				6.0mH	
61-MPC-025-1-11		2.5A				2.4mH	
61-MPC-036-1-11		3.6A				1.2mH	

Note: Test voltage: 1500VAC one minute, line to ground  
Insulation resistance: 300 Mohm min. at 500VDC  
Voltage drop: 1V max. at rated current  
Weight: 17.5g

# PCB Power Filters Miniature Printed Circuit Board

## 61-MPC Series



Dimensions in inches (mm)

### Common Mode



### Temperature Characteristics



### 61-MPC



### 61-MPC

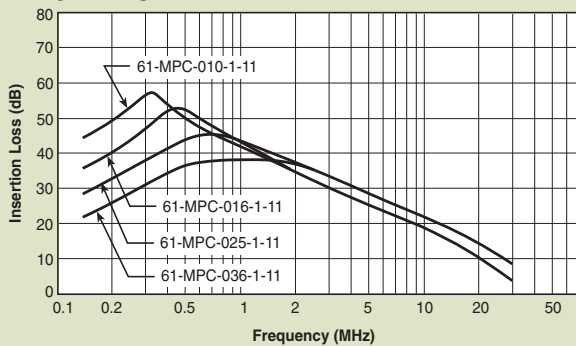

### Normal Mode



### 61-MPC



# Power Entry Modules Bolt-in Right Angle Terminals

for PCB Applications

## 60-BPP Series



Tested and found to be  
IAW VDE 0565 Part 3

### Features

- Ideally suited for products that must conform to FCC part 15 regulations
- Metal case offers high performance
- Meets over voltage of IEC 664 category II and complies with IEC 950
- Uses IEC connector that meets most safety standards Solder lug, Fast-on tab styles available (see page PF18)
- PCB mounting style minimizes space and provides economical installation
- Operating temperature: -25°C to +85°C (including temperature rise, see graph on page PF47)
- UL approved low leakage version also available

### Applications

- Digital equipment
- Personal computers and peripherals
- Measuring instruments
- Monitor and display units



### Circuit Diagram



### Specifications

Model	Rated Voltage (@ 50/60Hz)	Rated Current	Leakage Current (Max.)	Capacitance		Inductance (L <sub>1</sub> )	Temperature Rise (Max.)	
				C <sub>Y</sub>	C <sub>X</sub>			
60-BPP-010-3-2	250VAC	1A	0.35mA	2200pF	0.022uF	6.0mH	30°C	
60-BPP-010-3-4					0.047uF			
60-BPP-010-5-2			0.50mA	3300pF	0.022uF			
60-BPP-010-5-4					0.047uF			
60-BPP-020-3-2		2A	0.35mA	2200pF	0.022uF	2.4mH		
60-BPP-020-3-4					0.047uF			
60-BPP-020-5-2			0.50mA	3300pF	0.022uF			
60-BPP-020-5-4					0.047uF			
60-BPP-030-3-2		3A	0.35mA	2200pF	0.022uF	1.2mH		
60-BPP-030-3-4					0.047uF			
60-BPP-030-5-2			0.50mA	3300pF	0.022uF			
60-BPP-030-5-4					0.047uF			
60-BPP-060-3-2		6A	0.35mA	2200pF	0.022uF	0.53mH		45°C
60-BPP-060-3-4					0.047uF			
60-BPP-060-5-2			0.50mA	3300pF	0.022uF			
60-BPP-060-5-4					0.047uF			

Note: Test voltage: 1500VAC one minute, line to ground  
 Insulation resistance: 300 Mohm min. at 500VDC  
 Voltage drop: 1V max. at rated current  
 Weight: 50g  
 Input: Compatible with IEC-320



# Power Entry Modules Bolt-in Right Angle Terminals

for PCB Applications

## 60-BPP Series

### Temperature Characteristics



### 60-BPP PCB Mounting Type



### Common Mode



#### 60-BPP-010;-020



#### 60-BPP-030;-060



### Normal Mode



#### 60-BPP-010;-020



#### 60-BPP-030;-060



# Power Entry Modules High Frequency Attenuation

Bolt-in for PCB Applications

## 60-BHP Series



Tested and found to be  
IAW VDE 0565 Part 3

### Features

- Ideally suited for products that must conform to FCC part 15 regulations
- Metal cased filter offers high performance
- Meets over voltage of IEC 664 category II and complies with IEC 950
- Solder lug, Fast-on tab styles available (see page PF20)
- PCB mounting minimizes space and provides economical installation
- Excellent filtering characteristics for high frequencies
- Earth coil standard
- Operating temperature: -25°C to +85°C (including temperature rise, see graph on page PF49)

### Applications

- Digital equipment
- Personal computers and peripherals
- Measuring instruments
- Monitor and display units



### Circuit Diagram



### Specifications

Model	Rated Voltage (@ 50/60Hz)	Rated Current	Leakage Current (Max.)	Capacitance		Inductance		Temperature Rise (Max.)
				C <sub>Y</sub>	C <sub>X</sub>	(L <sub>1</sub> )	(L <sub>2</sub> )	
60-BHP-010-3-11	250VAC	1A	0.35mA	2200pF±20%	0.1uF±20%	6mH	18.3 uH	30°C
60-BHP-010-3-4					.047uF±20%			
60-BHP-010-5-11			0.50mA	3300pF±20%	0.1uF±20%			
60-BHP-010-5-4					.047uF±20%			
60-BHP-020-3-11		2A	0.35mA	2200pF±20%	0.1uF±20%	2.4mH		
60-BHP-020-3-4					.047uF±20%			
60-BHP-020-5-11			0.50mA	3300pF±20%	0.1uF±20%			
60-BHP-020-5-4					.047uF±20%			
60-BHP-030-3-11		3A	0.35mA	2200pF±20%	0.1uF±20%	1.2mH		
60-BHP-030-3-4					.047uF±20%			
60-BHP-030-5-11			0.50mA	3300pF±20%	0.1uF±20%			
60-BHP-030-5-4					.047uF±20%			
60-BHP-060-3-11		6A	0.35mA	2200pF±20%	0.1uF±20%	0.53mH		45°C
60-BHP-060-3-4					.047uF±20%			
60-BHP-060-5-11			0.50mA	3300pF±20%	0.1uF±20%			
60-BHP-060-5-4					.047uF±20%			

Note: Test voltage: 1500VAC one minute, line to ground  
 Insulation resistance: 300 Mohm min. at 500VDC  
 Voltage drop: 1V max. at rated current  
 Weight: 50g  
 Input: Compatible with IEC-320

# Power Entry Modules High Frequency Attenuation

Bolt-in for PCB Applications

## 60-BHP Series



### 60-BHP PCB Mounting Type



Компания «Океан Электроники» предлагает заключение долгосрочных отношений при поставках импортных электронных компонентов на взаимовыгодных условиях!

Наши преимущества:

- Поставка оригинальных импортных электронных компонентов напрямую с производств Америки, Европы и Азии, а так же с крупнейших складов мира;
- Широкая линейка поставок активных и пассивных импортных электронных компонентов (более 30 млн. наименований);
- Поставка сложных, дефицитных, либо снятых с производства позиций;
- Оперативные сроки поставки под заказ (от 5 рабочих дней);
- Экспресс доставка в любую точку России;
- Помощь Конструкторского Отдела и консультации квалифицированных инженеров;
- Техническая поддержка проекта, помощь в подборе аналогов, поставка прототипов;
- Поставка электронных компонентов под контролем ВП;
- Система менеджмента качества сертифицирована по Международному стандарту ISO 9001;
- При необходимости вся продукция военного и аэрокосмического назначения проходит испытания и сертификацию в лаборатории (по согласованию с заказчиком);
- Поставка специализированных компонентов военного и аэрокосмического уровня качества (Xilinx, Altera, Analog Devices, Intersil, Interpoint, Microsemi, Actel, Aeroflex, Peregrine, VPT, Syfer, Eurofarad, Texas Instruments, MS Kennedy, Miteq, Cobham, E2V, MA-COM, Hittite, Mini-Circuits, General Dynamics и др.);

Компания «Океан Электроники» является официальным дистрибьютором и эксклюзивным представителем в России одного из крупнейших производителей разъемов военного и аэрокосмического назначения «JONHON», а так же официальным дистрибьютором и эксклюзивным представителем в России производителя высокотехнологичных и надежных решений для передачи СВЧ сигналов «FORSTAR».



## JONHON

«JONHON» (основан в 1970 г.)

Разъемы специального, военного и аэрокосмического назначения:

(Применяются в военной, авиационной, аэрокосмической, морской, железнодорожной, горно- и нефтедобывающей отраслях промышленности)

«FORSTAR» (основан в 1998 г.)

ВЧ соединители, коаксиальные кабели, кабельные сборки и микроволновые компоненты:

(Применяются в телекоммуникациях гражданского и специального назначения, в средствах связи, РЛС, а так же военной, авиационной и аэрокосмической отраслях промышленности).



Телефон: 8 (812) 309-75-97 (многоканальный)

Факс: 8 (812) 320-03-32

Электронная почта: [ocean@oceanchips.ru](mailto:ocean@oceanchips.ru)

Web: <http://oceanchips.ru/>

Адрес: 198099, г. Санкт-Петербург, ул. Калинина, д. 2, корп. 4, лит. А