

Class R Fuseblocks Catalog Data

Catalog Number	Covers		Voltage	Current	Number of Poles	Label
	Class R	w/o Indication				
RM25100-1CR	CVR-RH-25100	CVRI-RH-25100	250	100	1	RM25100-1CR
RM25100-2CR					2	RM25100-2CR
RM25100-3CR					3	RM25100-3CR
RM25200-1CR	CVR-RH-25200	CVRI-RH-25200		200	1	RM25200-1CR
RM25200-2CR					2	RM25200-2CR
RM25200-3CR					3	RM25200-3CR
RM25400-1CR	CVR-RH-25400	CVRI-RH-25400		400	1	RM25400-1CR
RM25400-2CR					2	RM25400-2CR
RM25400-3CR					3	RM25400-3CR
RM25600-1CR	CVR-RH-25600	CVRI-RH-25600		600	1	RM25600-1CR
RM25600-2CR					2	RM25600-2CR
RM25600-3CR					3	RM25600-3CR

Catalog Number	Covers		Voltage	Current	Number of Poles	Label
	Class R	w/o Indication				
RM60100-1CR	CVR-RH-60100	CVRI-RH-60100	600	100	1	RM60100-1CR
RM60100-2CR					2	RM60100-2CR
RM60100-3CR					3	RM60100-3CR
RM60200-1CR	CVR-RH-60200	CVRI-RH-60200		200	1	RM60200-1CR
RM60200-2CR					2	RM60200-2CR
RM60200-3CR					3	RM60200-3CR
RM60400-1CR	CVR-RH-60400	CVRI-RH-60400		400	1	RM60400-1CR
RM60400-2CR					2	RM60400-2CR
RM60400-3CR					3	RM60400-3CR
RM60600-1CR	CVR-RH-60600	CVRI-RH-60600		600	1	RM60600-1CR
RM60600-2CR					2	RM60600-2CR
RM60600-3CR					3	RM60600-3CR

COOPER Bussmann
St. Louis MO 63178

TITLE:

Class R fuse holder-CUST

SCALE: 1:1

SIZE: A3

SHEET: 1 OF 14



PUSH DOWN

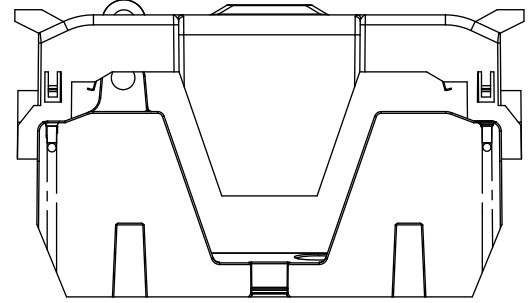
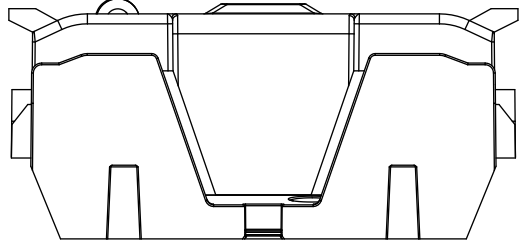

LIFT UP

LIFT UP, THEN ROTATE OVER

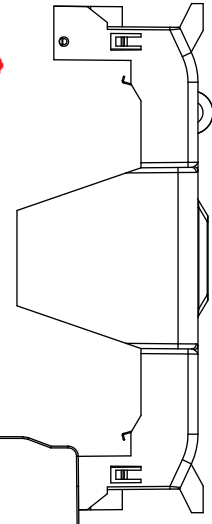
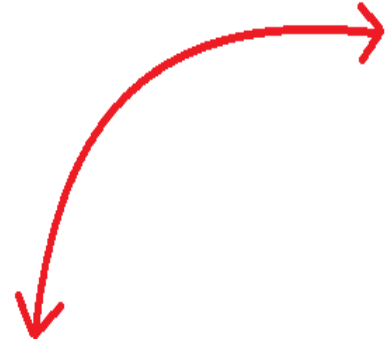

COOPER Bussmann
St. Louis MO 63178

TITLE:
Class R fuse holder-CUST

SCALE: 1:2 SIZE: A3 SHEET: 2 OF 14

www.Bussmann.com

RM25100-1CR

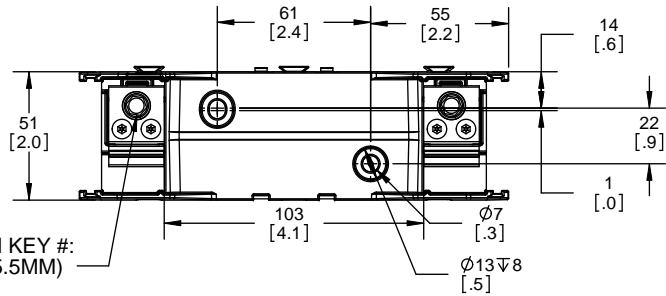

RM25100-1CR WITH CVR-RH-25100 INSTALLED

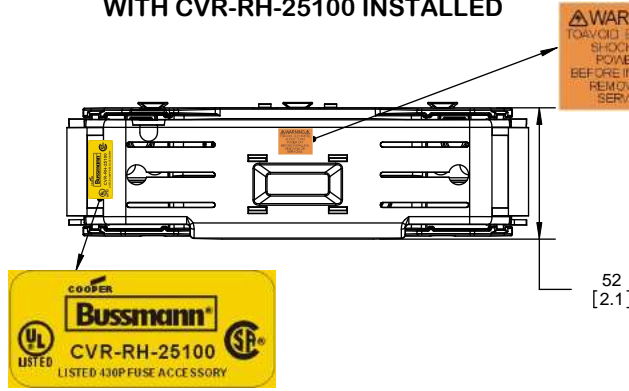

RM25100-1CR WITH CVRI-RH-25100 INSTALLED

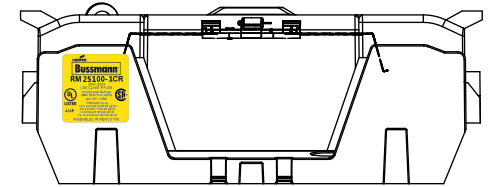
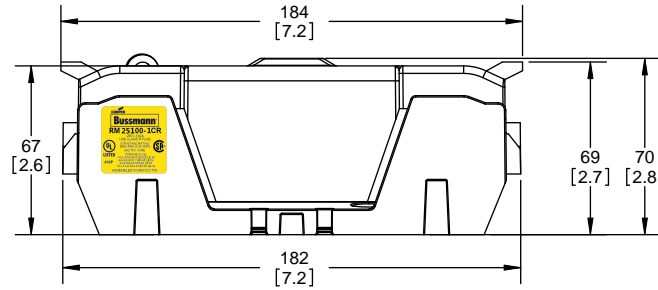
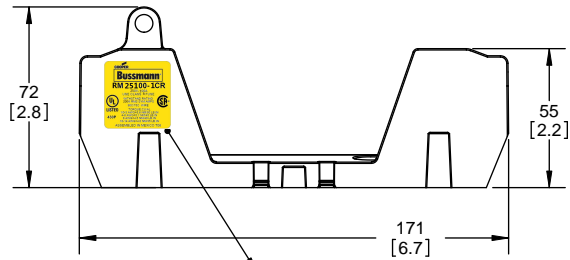
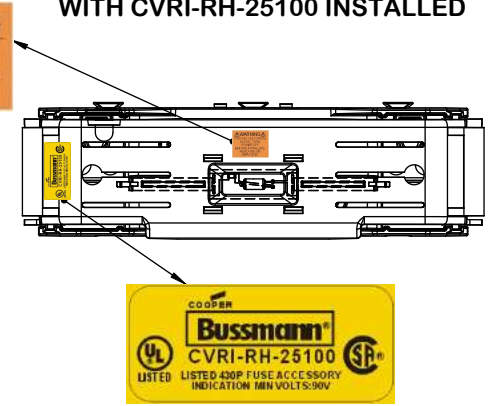

CVR-RH-25100

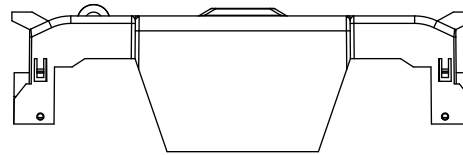

CVRI-RH-25100

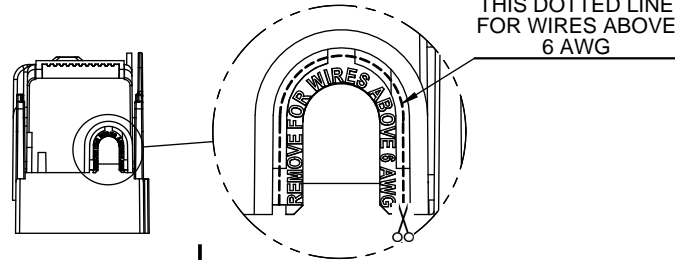
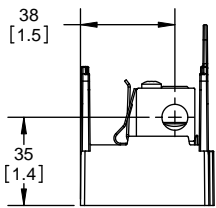
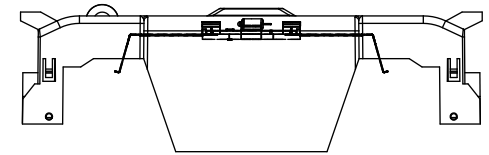

COOPER Bussmann
St. Louis MO 63178

TITLE: **Class R fuse holder-CUST-250V**

SCALE: 1:1 SIZE: A3 SHEET: 3 OF 14

DESIGN UNITS: METRIC (mm)
UNLESS OTHERWISE SPECIFIED
[INCHES]



THIRD ANGLE PROJECTION

RM25100-2CR

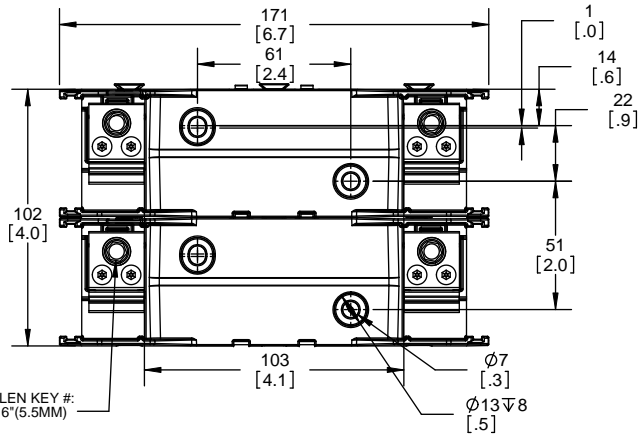

**RM25100-2CR
WITH CVR-RH-25100 INSTALLED**

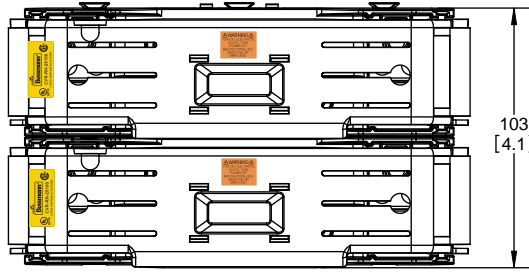

**RM25100-2CR
WITH CVRI-RH-25100 INSTALLED**

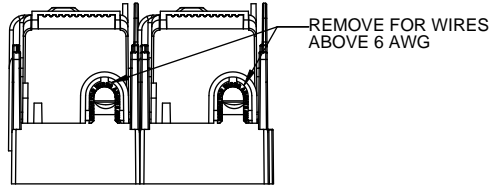
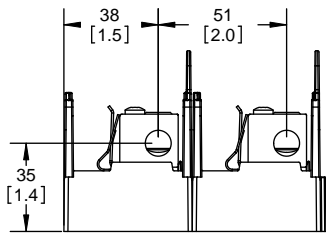
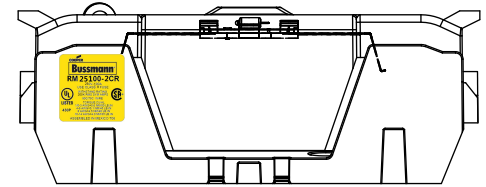
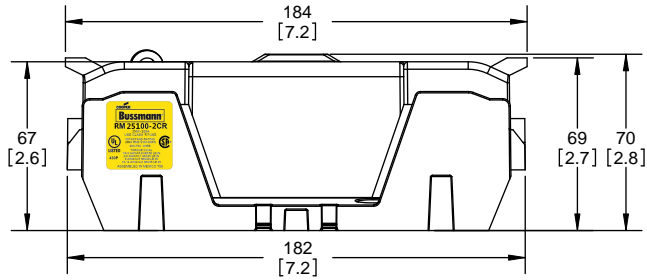
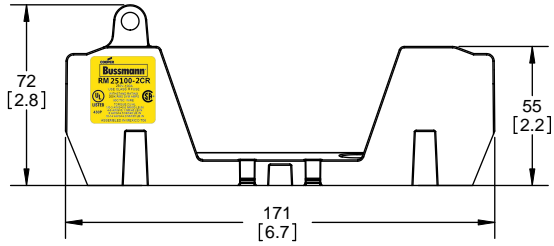
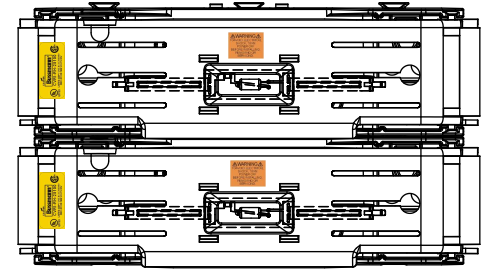

COOPER Bussmann
St. Louis MO 63178

Class R fuse holder-CUST-250V

SCALE: 1:1 SIZE: A3 SHEET: 4 OF 14

DESIGN UNITS: METRIC (mm)
UNLESS OTHERWISE SPECIFIED [INCHES]



THIRD ANGLE PROJECTION

RM25100-3CR

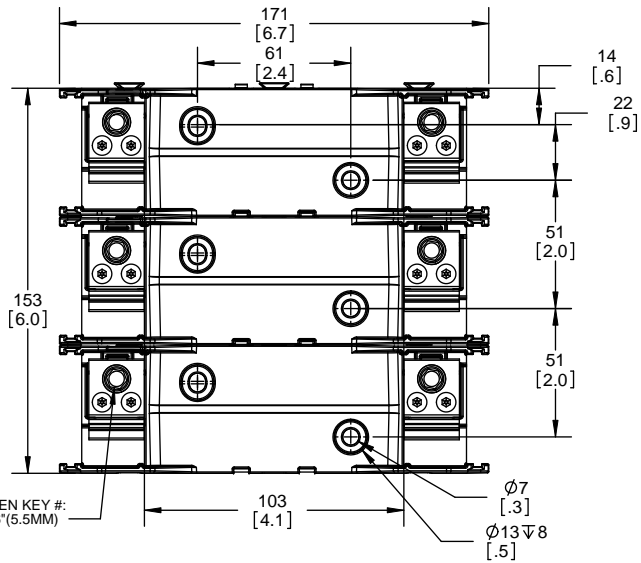

**RM25100-3CR
WITH CVR-RH-25100 INSTALLED**

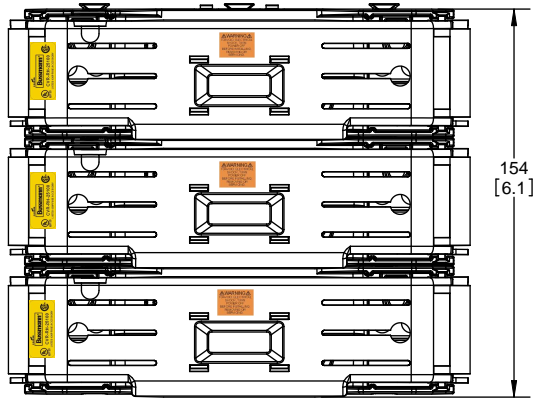

**RM25100-3CR
WITH CVRI-RH-25100 INSTALLED**

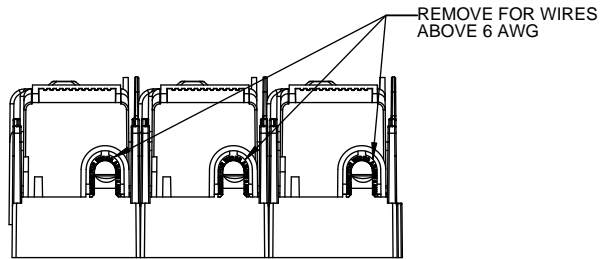
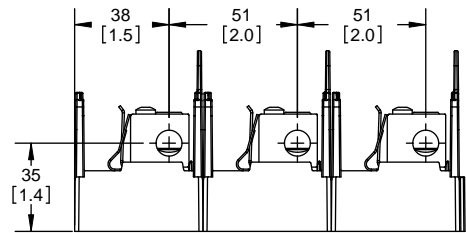
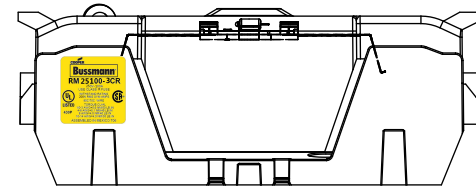
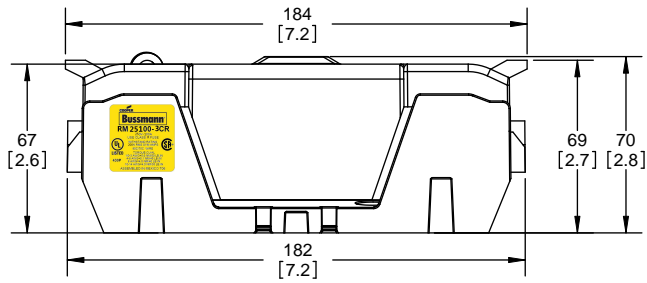
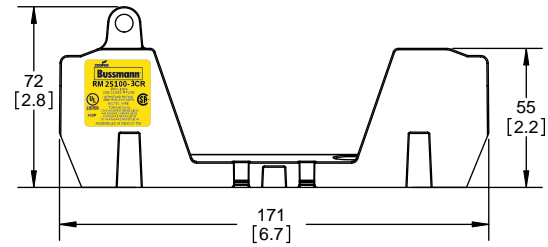
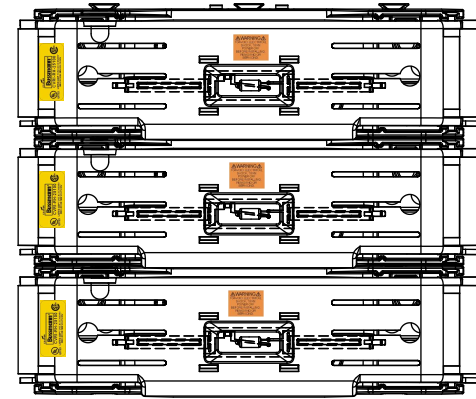

COOPER Bussmann
St. Louis MO 63178

Class R fuse holder-CUST-250V

SCALE: 1:1 SIZE: A3 SHEET: 5 OF 14

DESIGN UNITS: METRIC (mm)
UNLESS OTHERWISE SPECIFIED
[INCHES]



THIRD ANGLE PROJECTION

RM25200-2CR

**RM25200-2CR
WITH CVR-RH-25200 INSTALLED**

**RM25200-2CR
WITH CVRI-RH-25200 INSTALLED**



COOPER Bussmann
St. Louis MO 63178

TITLE:
Class R fuse holder-CUST-250V

SCALE: 1:1 SIZE: A3 SHEET: 7 OF 14

DESIGN UNITS: METRIC (mm)
UNLESS OTHERWISE SPECIFIED [INCHES]



THIRD ANGLE PROJECTION

RM25200-3CR

**RM25200-3CR
WITH CVR-RH-25200 INSTALLED**

**RM25200-3CR
WITH CVRI-RH-25200 INSTALLED**

ALLEN KEY #:
3/8" (10.0MM)

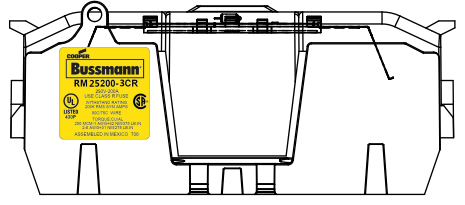
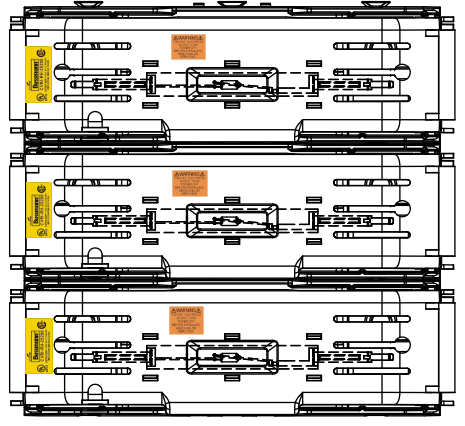

COOPER Bussmann
St. Louis MO 63178

TITLE:
Class R fuse holder-CUST-250V

SCALE: 1:1 SIZE: A3 SHEET: 8 OF 14

DESIGN UNITS: METRIC (mm)
UNLESS OTHERWISE SPECIFIED
[INCHES]

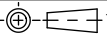

THIRD ANGLE PROJECTION

RM25400-1CR

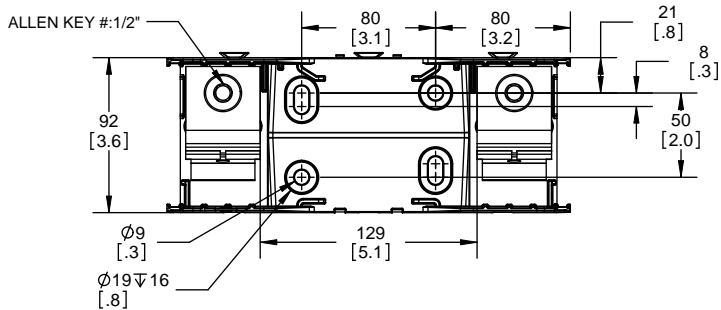

**RM25400-1CR
WITH CVR-RH-25400 INSTALLED**

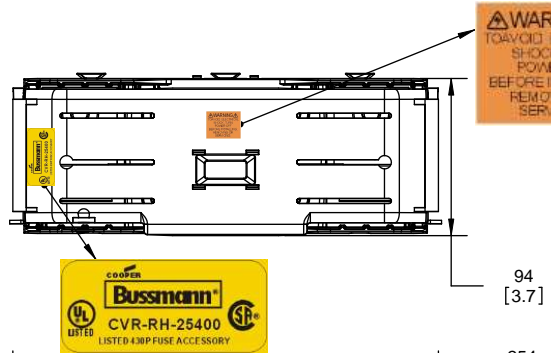

**RM25400-1CR
WITH CVRI-RH-25400 INSTALLED**

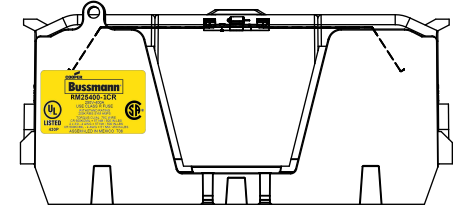
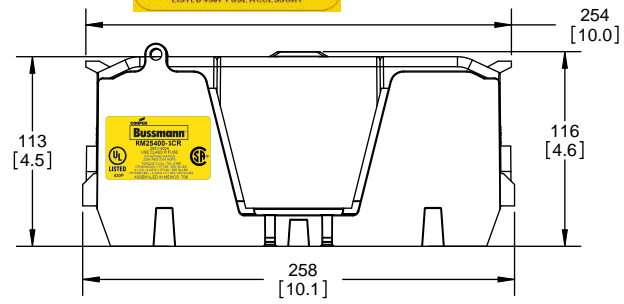
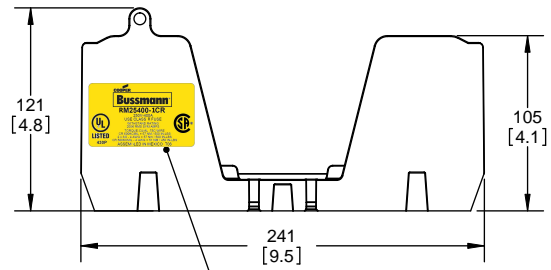
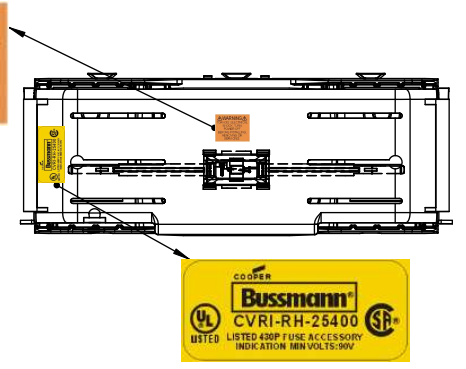

CVR-RH-25400

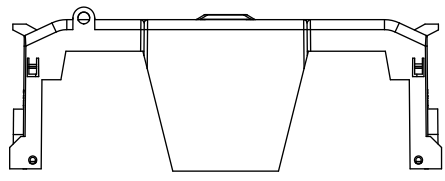

CVRI-RH-25400

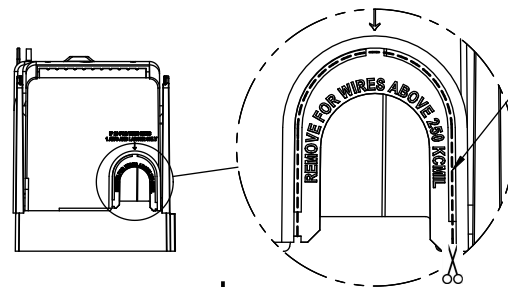
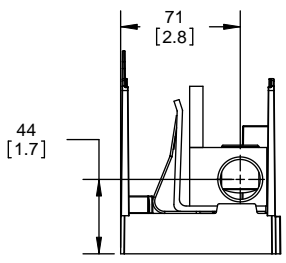
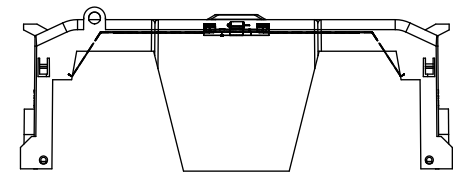

COOPER Bussmann
St. Louis MO 63178

Class R fuse holder-CUST-250V

SCALE: 1:1 SIZE: A3 SHEET: 9 OF 14

DESIGN UNITS: METRIC (mm)
UNLESS OTHERWISE SPECIFIED [INCHES]

THIRD ANGLE PROJECTION

RM25400-2CR

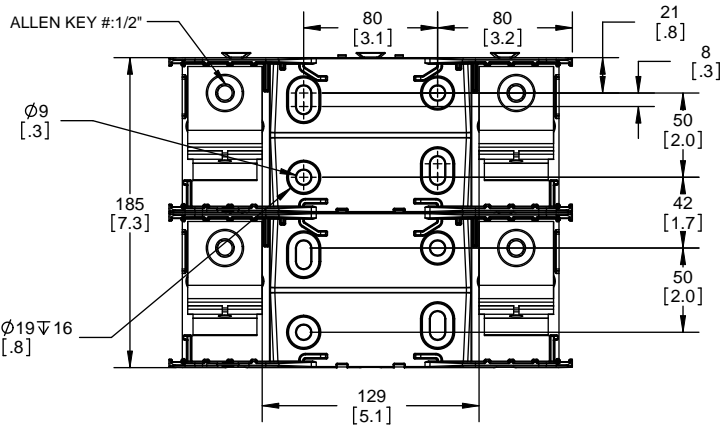

**RM25400-2CR
WITH CVR-RH-25400 INSTALLED**



**RM25400-2CR
WITH CVRI-RH-25400 INSTALLED**

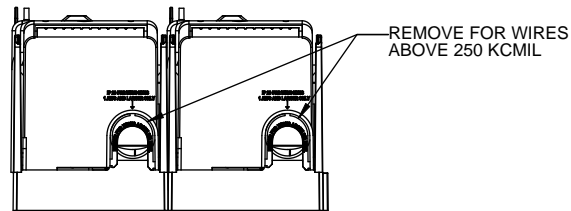
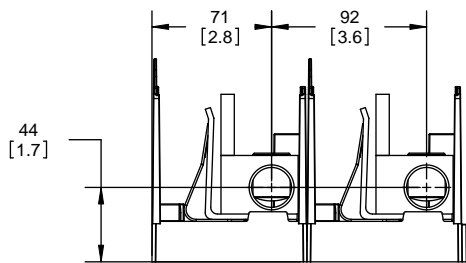
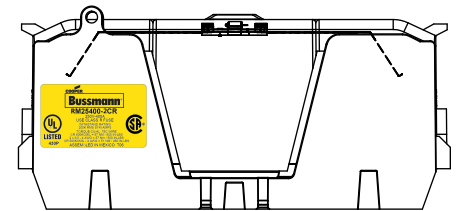
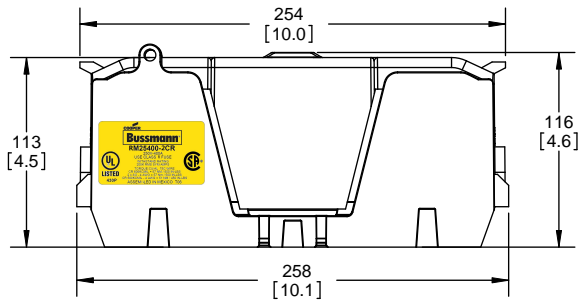
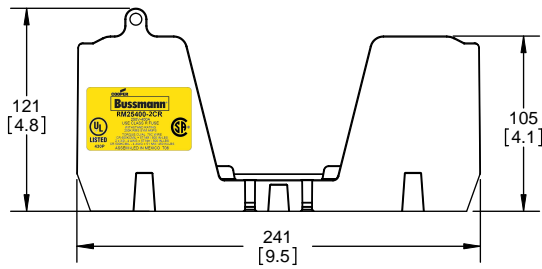
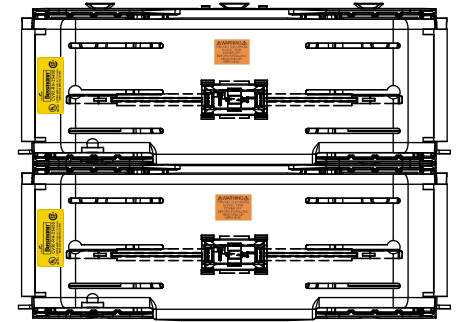

COOPER Bussmann
St. Louis MO 63178

TITLE:
Class R fuse holder-CUST-250V

SCALE: 1:1 SIZE: A3 SHEET: 10 OF 14

DESIGN UNITS: METRIC (mm)
UNLESS OTHERWISE SPECIFIED
[INCHES]



THIRD ANGLE PROJECTION

RM25400-3CR

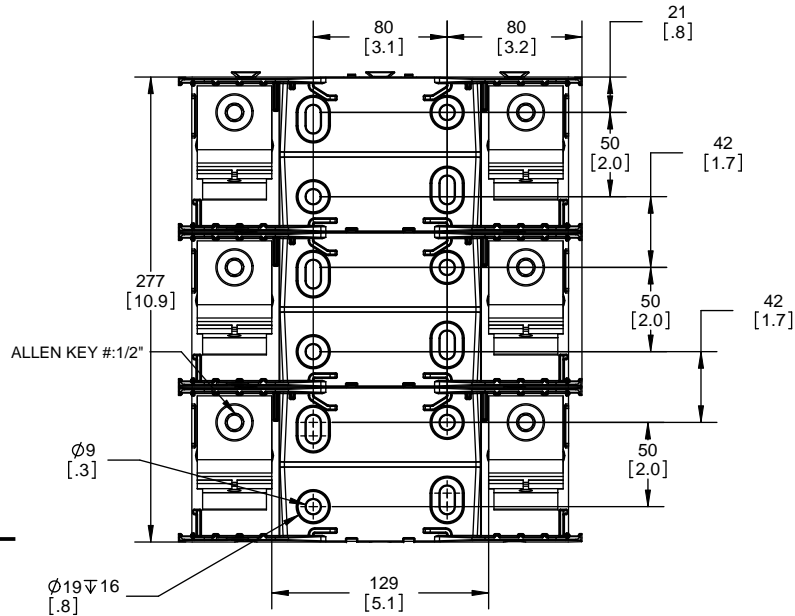

RM25400-3CR
WITH CVR-RH-25400 INSTALLED

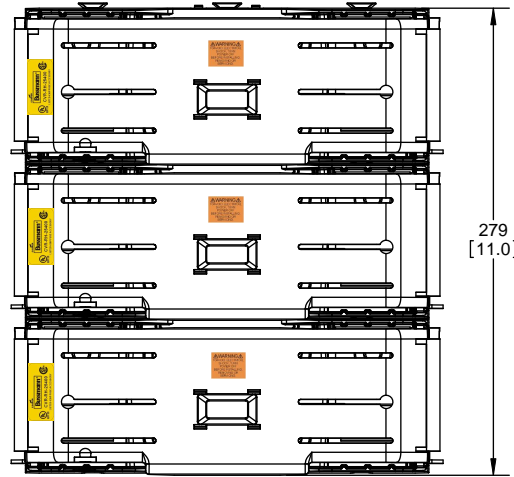

RM25400-3CR
WITH CVRI-RH-25400 INSTALLED

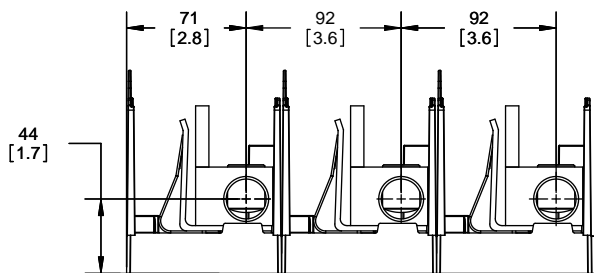
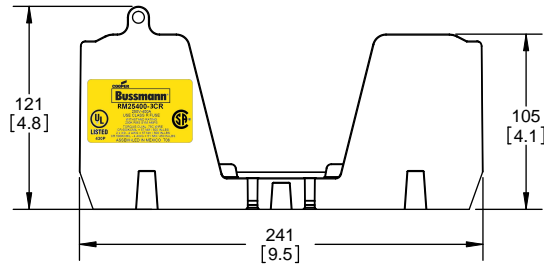

COOPER Bussmann
St. Louis MO 63178

TITLE:
Class R fuse holder-CUST-250V

SCALE: 1:1 SIZE: A3 SHEET: 11 OF 14

DESIGN UNITS: METRIC (mm) UNLESS OTHERWISE SPECIFIED
 THIRD ANGLE PROJECTION

RM25600-1CR

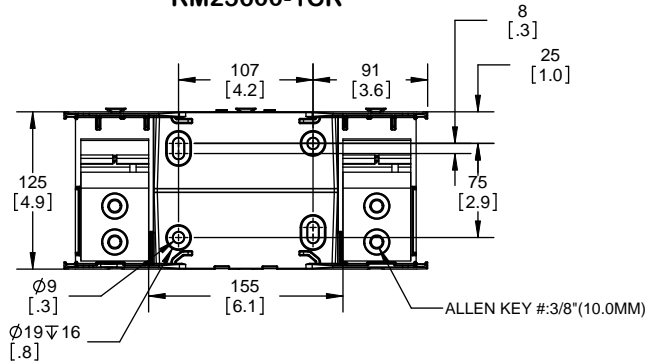

RM25600-1CR WITH CVR-RH-25600 INSTALLED

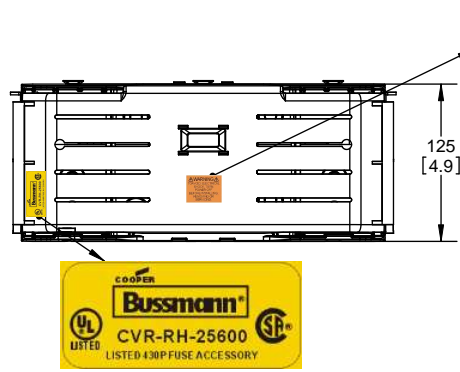

RM25600-1CR WITH CVRI-RH-25600 INSTALLED

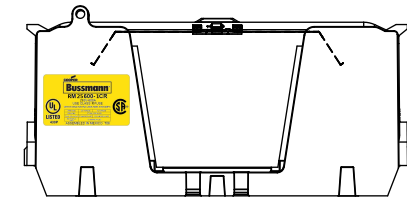
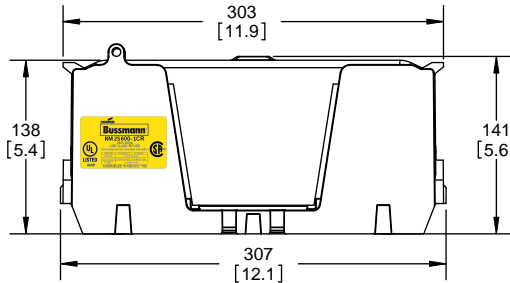
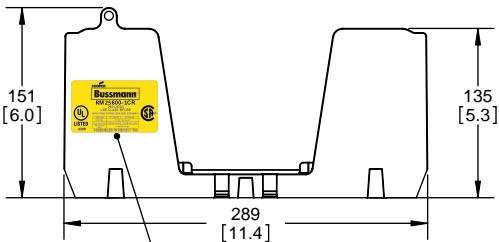
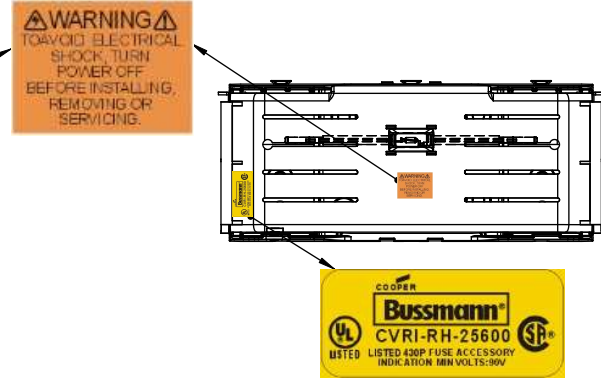

CVR-RH-25600

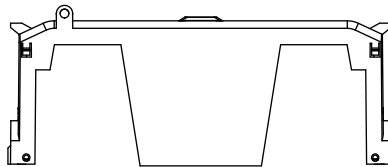

CVRI-RH-25600

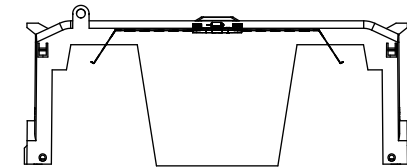

Bussmann
RM 25600-1CR
 250V-600A
 USE CLASS R FUSE
 WITHSTAND RATING 200K RMS SYM AMPS

WIRE SIZE	CUT TORQUE	AL TORQUE
600 KCMIL	87 NM / 620 IN-LBS	
DUAL 304 AWG	37 NM/600 IN-LBS	33.9 NM/300 IN-LBS
100 KCMIL	51 NM/450 IN-LBS	

UL LISTED 430P SA ASSEMBLED IN MEXICO T06

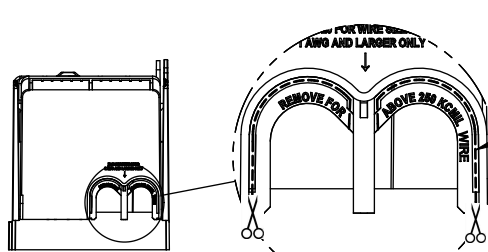

CUT OPEN ALONG THIS DOTTED LINE FOR WIRES ABOVE 250 KCMIL

COOPER Bussmann
 St. Louis MO 63178

Class R fuse holder-CUST-250V

SCALE: 1:1 SIZE: A3 SHEET: 12 OF 14

DESIGN UNITS: METRIC (mm)
UNLESS OTHERWISE SPECIFIED [INCHES]



THIRD ANGLE PROJECTION

RM25600-2CR

**RM25600-2CR
WITH CVR-RH-25600 INSTALLED**

**RM25600-2CR
WITH CVRI-RH-25600 INSTALLED**



COOPER Bussmann
St. Louis MO 63178

TITLE:
Class R fuse holder-CUST-250V

SCALE: 1:1 SIZE: A3 SHEET: 13 OF 14

DESIGN UNITS: METRIC (mm)
UNLESS OTHERWISE SPECIFIED
[INCHES]



THIRD ANGLE PROJECTION

RM25600-3CR



**RM25600-3CR
WITH CVR-RH-25600 INSTALLED**



**RM25600-3CR
WITH CVRI-RH-25600 INSTALLED**



COOPER Bussmann
St. Louis MO 63178

TITLE:
Class R fuse holder-CUST-250V

SCALE: 1:1 SIZE: A3 SHEET: 14 OF 14

REVISIONS			DATE	ECN	BY
REV	ZONE	DESCRIPTION			

RM60100-1CR

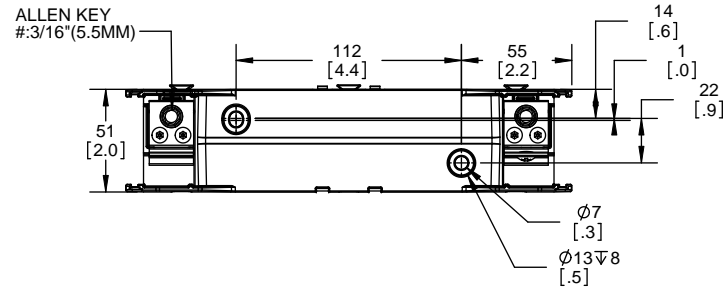

RM60100-1CR WITH CVR-RH-60100 INSTALLED

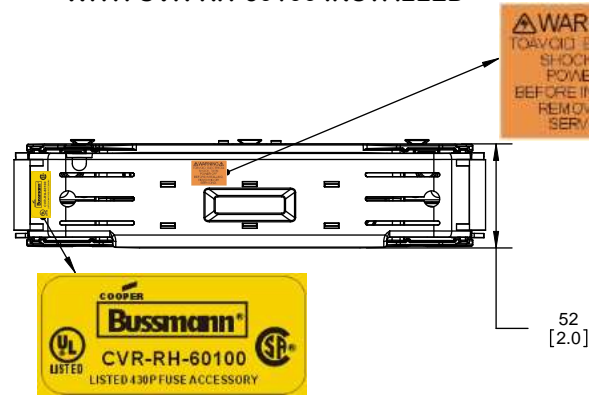

RM60100-1CR WITH CVRI-RH-60100 INSTALLED

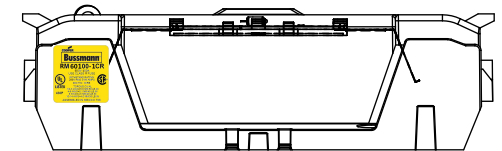
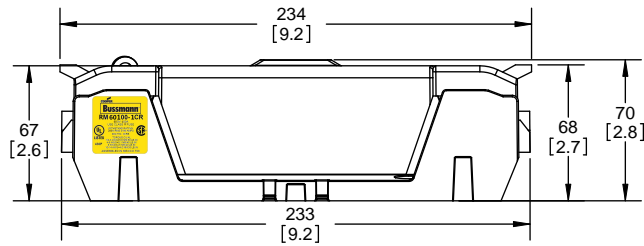
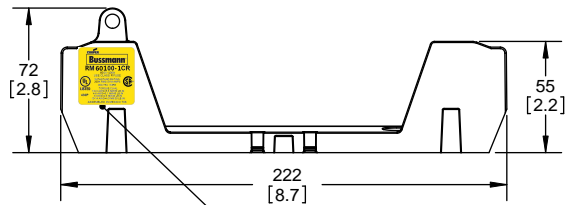
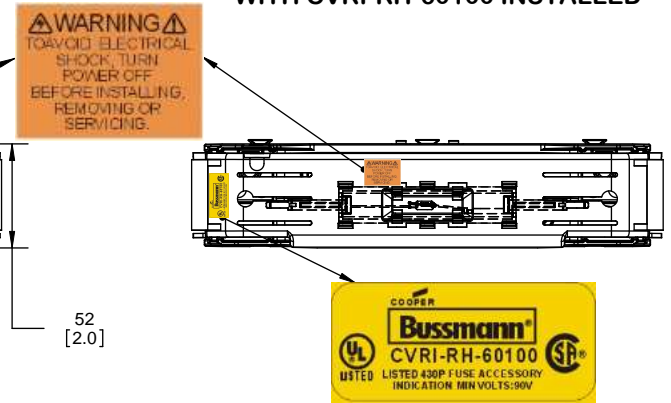

CVR-RH-60100

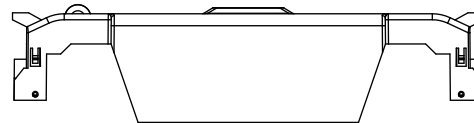

CVRI-RH-60100

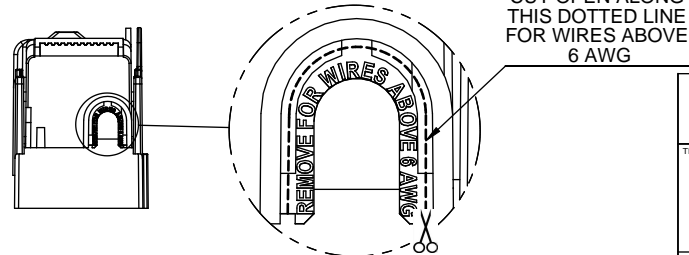
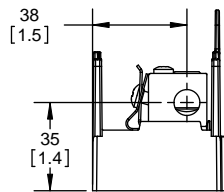
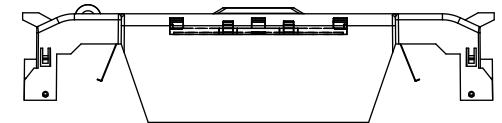

COOPER Bussmann
 St. Louis MO 63178

Class R fuse holder-CUST-600V

SCALE: 1:1 SIZE: A3 SHEET: 1 OF 12

REVISIONS					
REV	ZONE	DESCRIPTION	DATE	ECN	BY

RM60100-2CR

**RM60100-2CR
WITH CVR-RH-60100 INSTALLED**

**RM60100-2CR
WITH CVRI-RH-60100 INSTALLED**

ALLEN KEY
#3/16" (5.5MM)

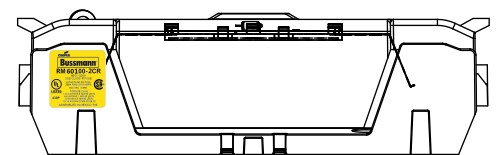

COOPER Bussmann
St. Louis MO 63178

TITLE:
Class R fuse holder-CUST-600V

SCALE: 1:1 SIZE: A3 SHEET: 2 OF 12

RM60100-3CR

RM60100-3CR WITH CVR-RH-60100 INSTALLED

RM60100-3CR WITH CVRI-RH-60100 INSTALLED

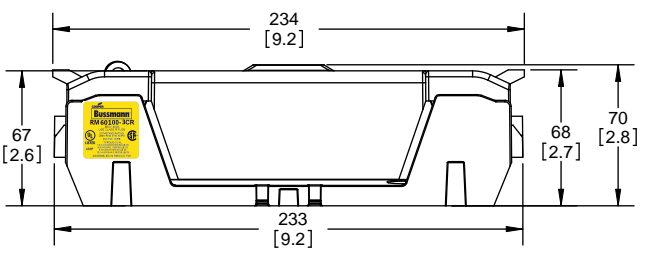

COOPER Bussmann
St. Louis MO 63178

TITLE:
Class R fuse holder-CUST-600V

SCALE: 1:1 SIZE: A3 SHEET: 3 OF 12

REVISIONS			DATE	ECN	BY
REV	ZONE	DESCRIPTION			

RM60200-1CR

RM60200-1CR WITH CVR-RH-60200 INSTALLED

RM60200-1CR WITH CVRI-RH-60200 INSTALLED

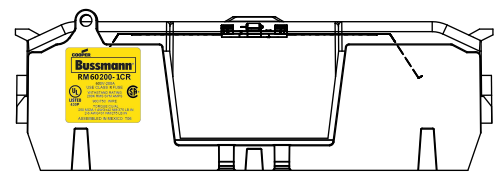
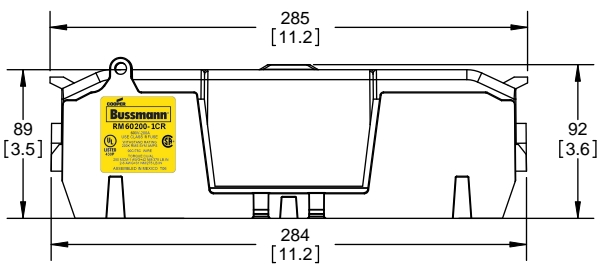
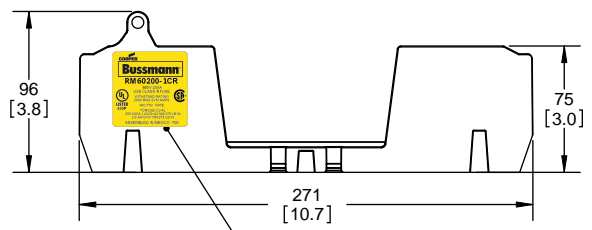
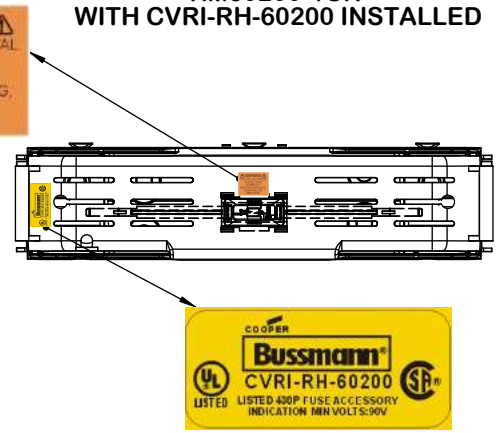
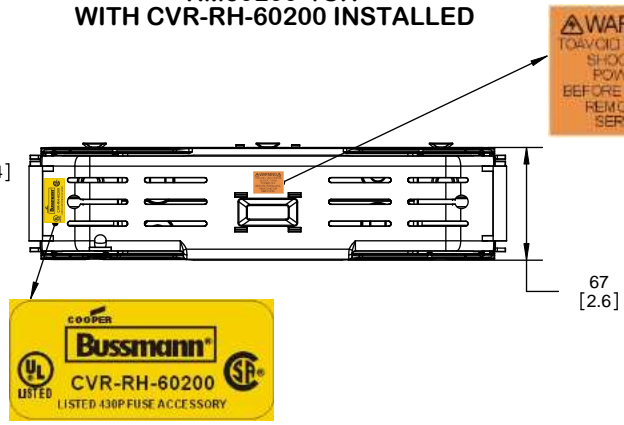
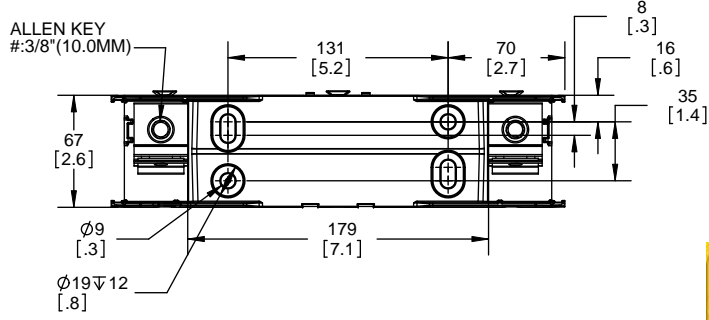

CVR-RH-60200

CVRI-RH-60200

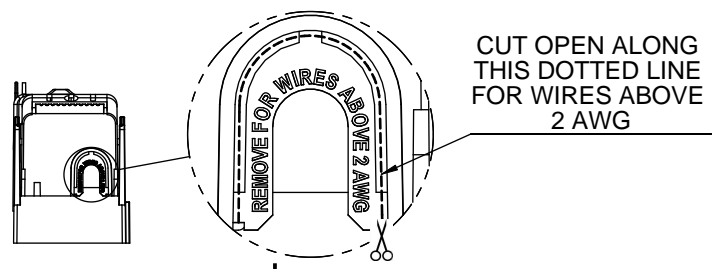
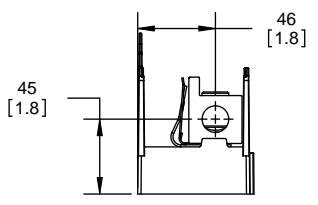
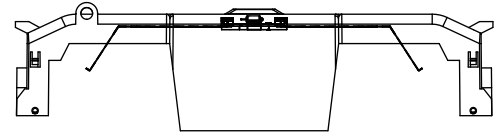
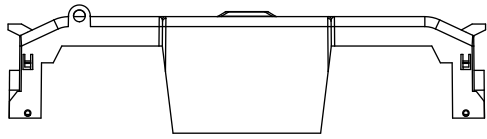

COOPER Bussmann
St. Louis MO 63178

TITLE: **Class R fuse holder-CUST-600V**

SCALE: 1:1 SIZE: A3 SHEET: 4 OF 12

RM60200-2CR

**RM60200-2CR
WITH CVR-RH-60200 INSTALLED**

**RM60200-2CR
WITH CVRI-RH-60200 INSTALLED**

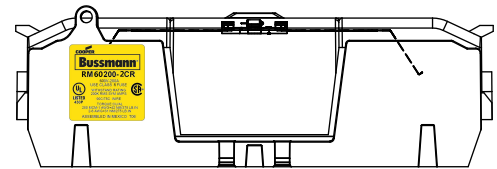
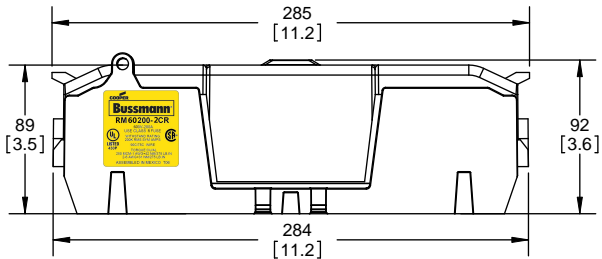
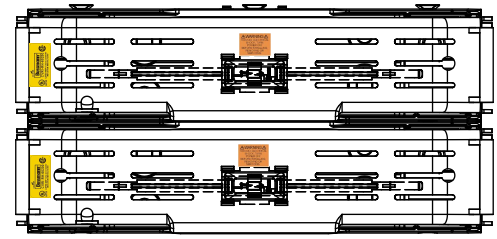
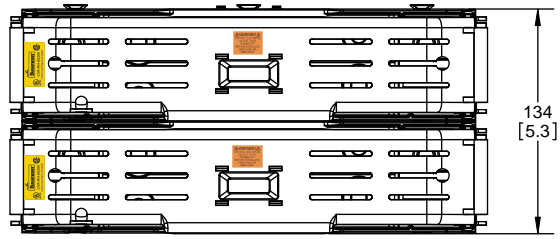

COOPER Bussmann
St. Louis MO 63178

TITLE:
Class R fuse holder-CUST-600V

SCALE: 1:1 SIZE: A3 SHEET: 5 OF 12

RM60200-3CR

**RM60200-3CR
WITH CVR-RH-60200 INSTALLED**

**RM60200-3CR
WITH CVRI-RH-60200 INSTALLED**

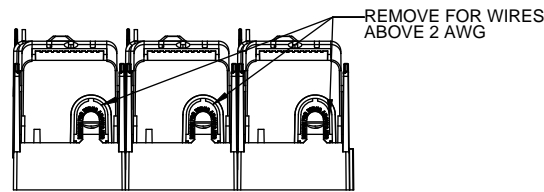
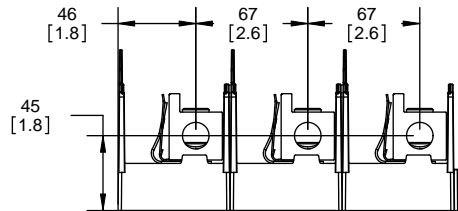
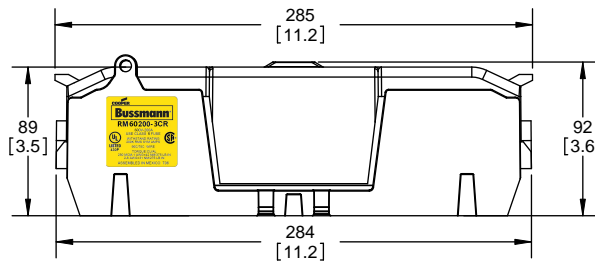
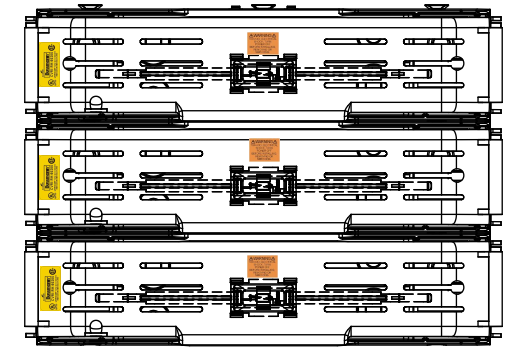
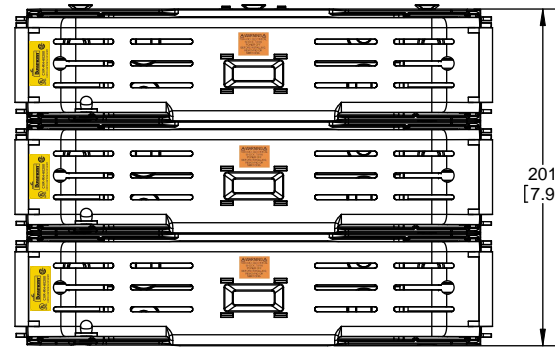
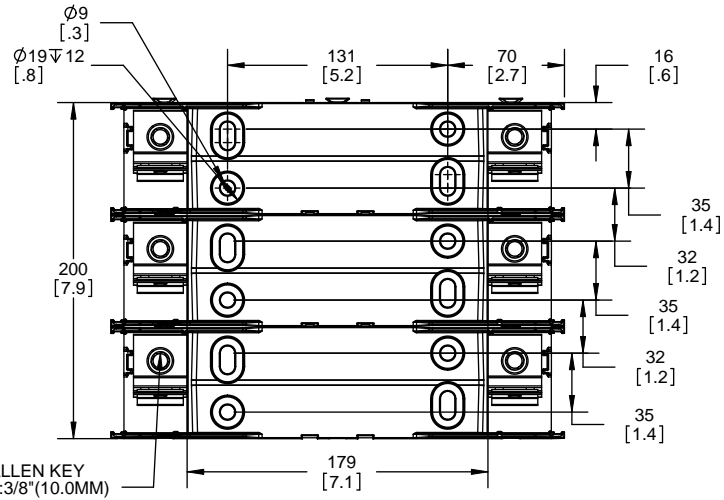

COOPER Bussmann
St. Louis MO 63178

TITLE: **Class R fuse holder-CUST-600V**

SCALE: 1:1 SIZE: A3 SHEET: 6 OF 12

RM60400-1CR



RM60400-1CR WITH CVR-RH-60400 INSTALLED



RM60400-1CR WITH CVRI-RH-60400 INSTALLED



COOPER Bussmann RM60400-1CR
600V-400A
USE CLASS R FUSE
WITHSTAND RATING
200K RMS SYM AMPS
TORQUE CU/AL 75C WIRE
CR 600KCMIL = 57 NM / 500 IN-LBS
2 x 3/0 - 4 AWG = 57 NM / 500 IN-LBS
CR 500KCMIL - 4 AWG = 51 NM / 450 IN-LBS
ASSEMBLED IN MEXICO T06

UL LISTED 430P

CVR-RH-60400

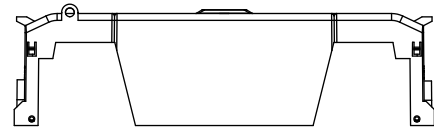

CVRI-RH-60400



CUT OPEN ALONG THIS DOTTED LINE FOR WIRES ABOVE 250 KCMIL

COOPER Bussmann
St. Louis MO 63178

TITLE: **Class R fuse holder-CUST-600V**

SCALE: 1:1 SIZE: A3 SHEET: 7 OF 12

REVISIONS			DATE	ECN	BY
REV	ZONE	DESCRIPTION			

RM60400-2CR



**RM60400-2CR
WITH CVR-RH-60400 INSTALLED**



**RM60400-2CR
WITH CVRI-RH-60400 INSTALLED**

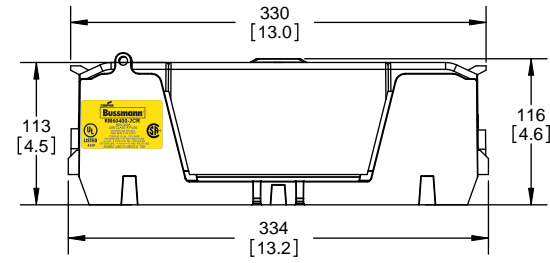

COOPER Bussmann
St. Louis MO 63178

TITLE:
Class R fuse holder-CUST-600V

SCALE: 1:1 SIZE: A3 SHEET: 8 OF 12

DESIGN UNITS: METRIC (mm)
UNLESS OTHERWISE SPECIFIED
[INCHES]

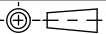

THIRD ANGLE PROJECTION

REVISIONS			DATE	ECN	BY
REV	ZONE	DESCRIPTION			

RM60400-3CR

**RM60400-3CR
WITH CVR-RH-60400 INSTALLED**

**RM60400-3CR
WITH CVRI-RH-60400 INSTALLED**

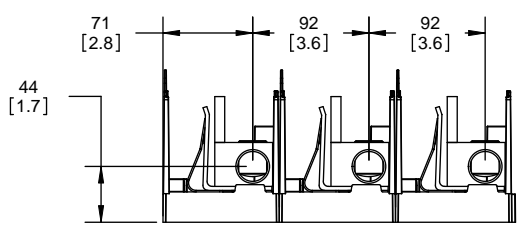
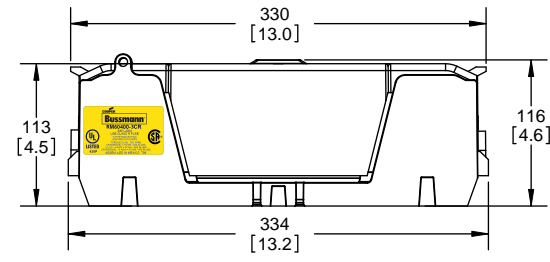
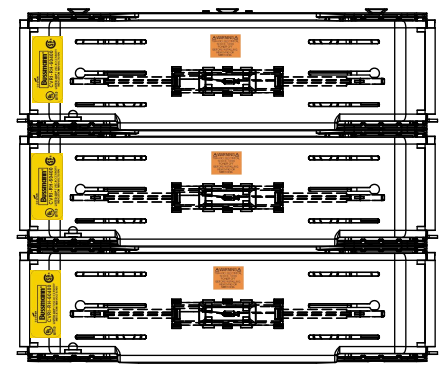
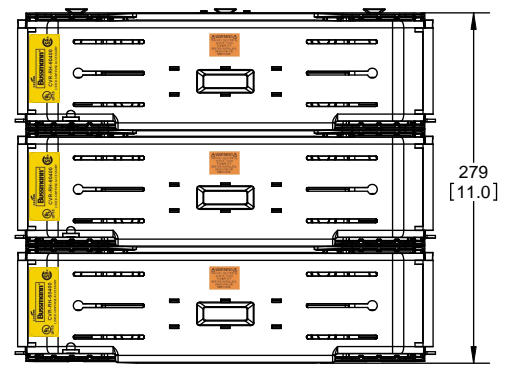
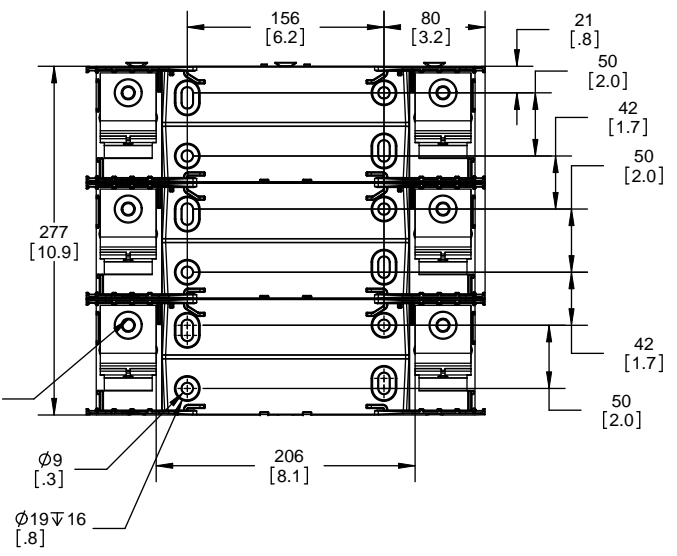

COOPER Bussmann
St. Louis MO 63178

TITLE:
Class R fuse holder-CUST-600V

SCALE: 1:1 SIZE: A3 SHEET: 9 OF 12

DESIGN UNITS: METRIC (mm)
UNLESS OTHERWISE SPECIFIED
[INCHES]

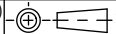

THIRD ANGLE PROJECTION

REVISIONS			DATE	ECN	BY
REV	ZONE	DESCRIPTION			

RM60600-2CR



**RM60600-2CR
WITH CVR-RH-60600 INSTALLED**



**RM60600-2CR
WITH CVRI-RH-60600 INSTALLED**



COOPER Bussmann
St. Louis MO 63178

TITLE:
Class R fuse holder-CUST-600V

SCALE: 1:5 SIZE: A3 SHEET: 11 OF 12

REVISIONS				DATE	ECN	BY
REV	ZONE	DESCRIPTION				

RM60600-3CR

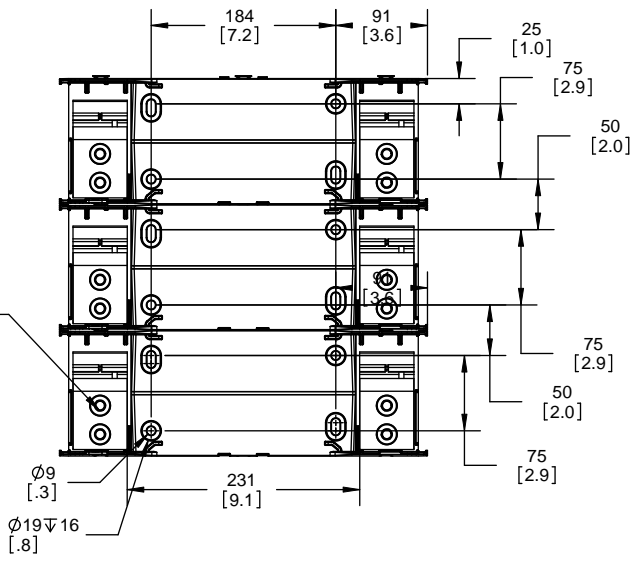

**RM60600-3CR
WITH CVR-RH-60600 INSTALLED**

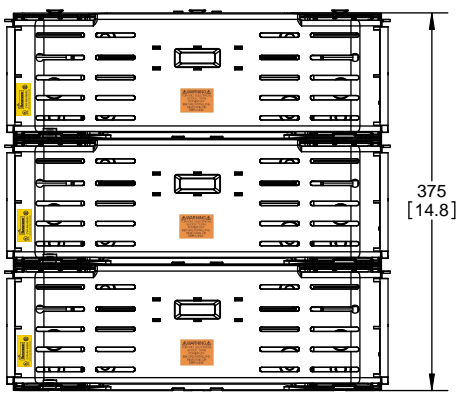

**RM60600-3CR
WITH CVRI-RH-60600 INSTALLED**

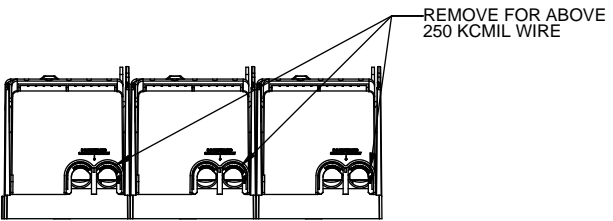
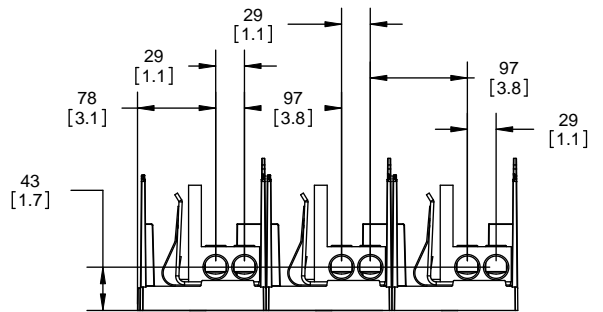
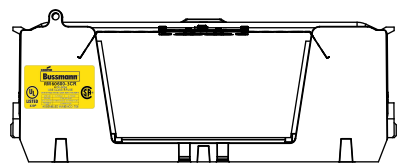
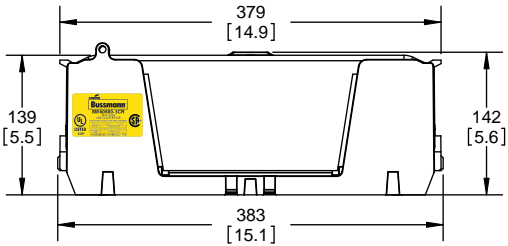
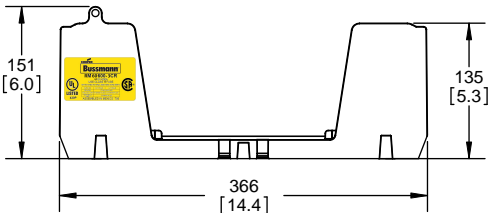
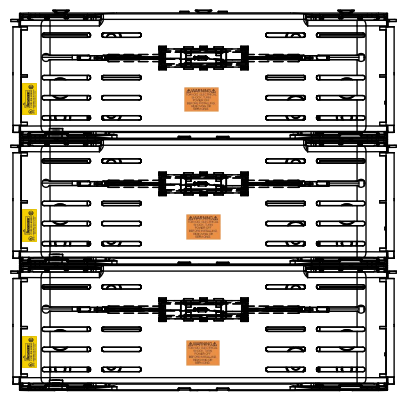

COOPER Bussmann
St. Louis MO 63178

TITLE:
Class R fuse holder-CUST-600V

SCALE: 1:5 SIZE: A3 SHEET: 12 OF 12

Компания «Океан Электроники» предлагает заключение долгосрочных отношений при поставках импортных электронных компонентов на взаимовыгодных условиях!

Наши преимущества:

- Поставка оригинальных импортных электронных компонентов напрямую с производств Америки, Европы и Азии, а так же с крупнейших складов мира;
- Широкая линейка поставок активных и пассивных импортных электронных компонентов (более 30 млн. наименований);
- Поставка сложных, дефицитных, либо снятых с производства позиций;
- Оперативные сроки поставки под заказ (от 5 рабочих дней);
- Экспресс доставка в любую точку России;
- Помощь Конструкторского Отдела и консультации квалифицированных инженеров;
- Техническая поддержка проекта, помощь в подборе аналогов, поставка прототипов;
- Поставка электронных компонентов под контролем ВП;
- Система менеджмента качества сертифицирована по Международному стандарту ISO 9001;
- При необходимости вся продукция военного и аэрокосмического назначения проходит испытания и сертификацию в лаборатории (по согласованию с заказчиком);
- Поставка специализированных компонентов военного и аэрокосмического уровня качества (Xilinx, Altera, Analog Devices, Intersil, Interpoint, Microsemi, Actel, Aeroflex, Peregrine, VPT, Syfer, Eurofarad, Texas Instruments, MS Kennedy, Miteq, Cobham, E2V, MA-COM, Hittite, Mini-Circuits, General Dynamics и др.);

Компания «Океан Электроники» является официальным дистрибьютором и эксклюзивным представителем в России одного из крупнейших производителей разъемов военного и аэрокосмического назначения «JONHON», а так же официальным дистрибьютором и эксклюзивным представителем в России производителя высокотехнологичных и надежных решений для передачи СВЧ сигналов «FORSTAR».



JONHON

«JONHON» (основан в 1970 г.)

Разъемы специального, военного и аэрокосмического назначения:

(Применяются в военной, авиационной, аэрокосмической, морской, железнодорожной, горно- и нефтедобывающей отраслях промышленности)

«FORSTAR» (основан в 1998 г.)

ВЧ соединители, коаксиальные кабели, кабельные сборки и микроволновые компоненты:

(Применяются в телекоммуникациях гражданского и специального назначения, в средствах связи, РЛС, а так же военной, авиационной и аэрокосмической отраслях промышленности).



Телефон: 8 (812) 309-75-97 (многоканальный)

Факс: 8 (812) 320-03-32

Электронная почта: ocean@oceanchips.ru

Web: <http://oceanchips.ru/>

Адрес: 198099, г. Санкт-Петербург, ул. Калинина, д. 2, корп. 4, лит. А