

# Field and Factory Programmable Spread Spectrum Clock Generator for EMI Reduction

## Features

- Wide Operating Output (SSCLK) Frequency Range
  - 3 MHz to 200 MHz
- Programmable Spread Spectrum with nominal 31.5 kHz Modulation Frequency
  - Center Spread:  $\pm 0.25\%$  to  $\pm 2.5\%$
  - Down Spread:  $-0.5\%$  to  $-5.0\%$
- Input frequency range
  - External Crystal: 8 to 30 MHz Fundamental Crystals
  - External Reference: 8 to 166 MHz Clock
- Integrated Phase-Locked Loop (PLL)
- Field Programmable devices available
- Programmable Crystal Load Capacitor Tuning Array
- Low Cycle-to-cycle Jitter
- Spread Spectrum on/off function
- Powerdown or Output Enable function
- Commercial and Industrial temperature ranges
- 3.3 V operation
- 8-pin TSSOP and SOIC packages

## Functional Description

The CY25100 is a Spread Spectrum Clock Generator (SSCG) IC used to reduce EMI found in today's high speed digital electronic systems.

The device uses a Cypress proprietary PLL and Spread Spectrum Clock (SSC) technology to synthesize and modulate the frequency of the input clock. By frequency modulating the clock, the measured EMI at the fundamental and harmonic frequencies are greatly reduced. This reduction in radiated energy can significantly reduce the cost of complying with regulatory agency (EMC) requirements and improve time-to-market without degrading system performance.

The CY25100 uses a factory or field-programmable configuration memory array to synthesize output frequency, spread percentage, crystal load capacitor, reference clock output on/off, spread spectrum on/off function, and PD#/OE options.

The spread percentage is programmed to either center spread or down spread with various spread percentages. The range for center spread is from  $\pm 0.25\%$  to  $\pm 2.50\%$ . The range for down spread is from  $-0.5\%$  to  $-5.0\%$ .

The input to the CY25100 can either be a crystal or a clock signal. The CY25100 has two clock outputs: REFCLK and SSCLK. The non-spread spectrum REFCLK output has the same frequency as the input of the CY25100.

For a complete list of related documentation, click [here](#).

## Logic Block Diagram

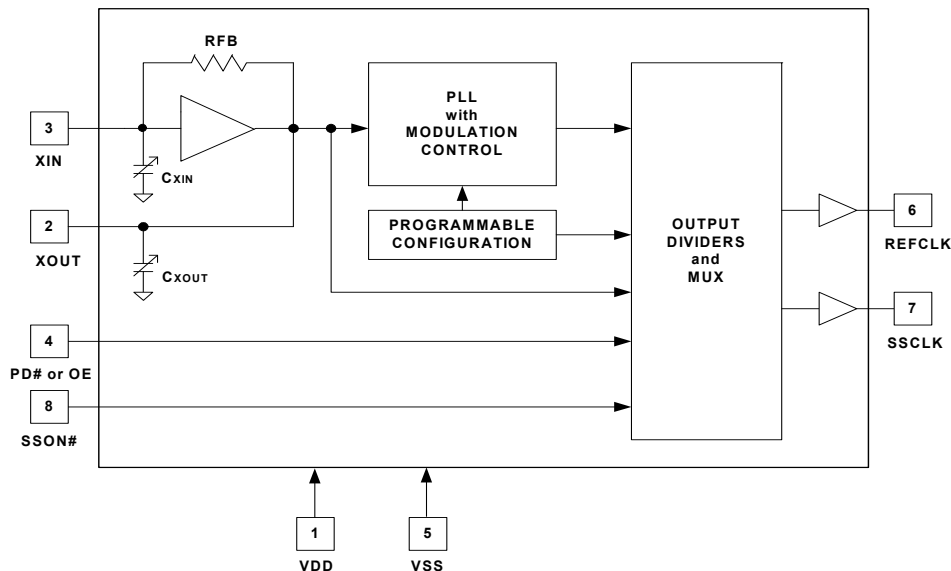

## Contents

<b>Pinouts</b> .....	<b>3</b>	<b>Thermal Resistance</b> .....	<b>6</b>
<b>Pin Description</b> .....	<b>3</b>	<b>Application Circuit</b> .....	<b>7</b>
<b>User Specified Variables</b> .....	<b>3</b>	<b>AC Electrical Characteristics</b> .....	<b>8</b>
<b>Programming Description</b> .....	<b>4</b>	<b>Switching Waveforms</b> .....	<b>9</b>
<b>Field Programmable CY25100</b> .....	<b>4</b>	<b>Informational Graphs</b> .....	<b>10</b>
CY3672 Programmer		<b>Ordering Information</b> .....	<b>12</b>
and CY3690/CY3691 Socket Adapters .....	4	Possible Configurations .....	12
Factory Programmable CY25100 .....	4	Ordering Code Definitions .....	13
<b>Product Functions</b> .....	<b>4</b>	<b>Package Diagrams</b> .....	<b>14</b>
Input Frequency (XIN, Pin 3 and XOUT, Pin 2) .....	4	<b>Acronyms</b> .....	<b>16</b>
CXIN and CXOUT (Pin 3 and Pin 2) .....	4	<b>Document Conventions</b> .....	<b>16</b>
Output Frequency (SSCLK, Pin 7) .....	4	Units of Measure .....	16
Spread Percentage (SSCLK, Pin 7) .....	4	<b>Document History Page</b> .....	<b>17</b>
Reference Output (REFOUT, Pin 6) .....	4	<b>Sales, Solutions, and Legal Information</b> .....	<b>19</b>
Modulation Frequency .....	4	Worldwide Sales and Design Support .....	19
Power Down or Output Enable (PD# or OE, Pin 4) .....	4	Products .....	19
<b>Absolute Maximum Ratings</b> .....	<b>5</b>	PSoC® Solutions .....	19
<b>Recommended Crystal Specifications</b> .....	<b>5</b>	Cypress Developer Community .....	19
<b>Operating Conditions</b> .....	<b>5</b>	Technical Support .....	19
<b>DC Electrical Characteristics</b> .....	<b>6</b>		

Pinouts

Figure 1. 8-pin SOIC/TSSOP pinout

CY25100

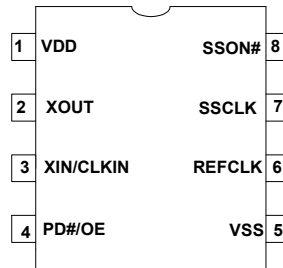

Pin Description

Pin	Name	Type	Description
1	VDD	Power	3.3 V power supply.
2	XOUT	Output	Crystal output. Leave this pin floating if external clock is connected to pin 3.
3	XIN/CLKIN	Input	Crystal input or reference clock input.
4	PD#/OE	Input	User has the option of choosing either PD# or OE function. Power Down pin: Active LOW. If PD# = 0, PLL and crystal oscillator circuit are powered down, and outputs are weakly pulled low. Output Enable pin: Active HIGH. If OE = 1, SSCLK and REFCLK are enabled.
5	VSS	Power	Power supply ground.
6	REFCLK	Output	Buffered reference output.
7	SSCLK	Output	Spread spectrum clock output.
8	SSON#	Input	Spread spectrum control: Active LOW. 0 = spread on. 1 = spread off.

User Specified Variables

Pin Function	Input Frequency	Total Crystal Load Capacitance	Output Frequency	Spread Percent (0.5% – 5%, 0.25% granularity)	Reference Output	Power Down or Output Enable
Pin Name	XIN and XOUT	XIN and XOUT	SSCLK	SSCLK	REFOUT	PD#/OE
Pin#	3 and 2	3 and 2	7	7	6	4
Unit	MHz	pF	MHz	% and Center- or Down-spread	On or Off	Select PD# or OE
	USER SPECIFIED	USER SPECIFIED	USER SPECIFIED	USER SPECIFIED	USER SPECIFIED	USER SPECIFIED

## Programming Description

### Field Programmable CY25100

The CY25100 is programmed at the package level, and must be programmed prior to installation on a circuit board. Field programmable devices are denoted by an “F” in the ordering code, and are blank when shipped. The CY25100 is Flash technology based, which allows it to be reprogrammed up to 100 times. This allows fast and easy design changes and product updates, and eliminates issues with old and out of date inventory.

Samples and small prototype quantities can be programmed on the CY3672 programmer with the CY3690 (TSSOP package) or CY3691 (SOIC package) socket adapter.

### CY3672 Programmer and CY3690/CY3691 Socket Adapters

The Cypress CY3672 programmer and the CY3690 or CY3691 socket adapter may be used to program field programmable versions of the CY25100. The CY3690 enables users to program the CY25100ZXCF and CY25100ZXIF (TSSOP). CY3691 provides the ability to program the CY25100SXCF and CY25100SXIF (SOIC). The CY3690 and CY3691 are separate orderable items, so the existing users of the CY3672 programmer need to order only the specific socket adapter to program the CY25100.

### Factory Programmable CY25100

Factory programming by Cypress is available for high volume orders. All requests must be submitted to the local Cypress Field Application Engineer (FAE) or sales representative. After the request is processed, you will receive a new part number, samples, and data sheet with the programmed values. This part number is used for additional sample requests and production orders.

## Product Functions

### Input Frequency (XIN, Pin 3 and XOUT, Pin 2)

The input to the CY25100 can be a crystal or a clock. The input frequency range for crystals is 8 to 30 MHz, and for clock signals is 8 to 166 MHz.

### C<sub>XIN</sub> and C<sub>XOUT</sub> (Pin 3 and Pin 2)

The CY25100 has internal load capacitors at Pin 3 (C<sub>XIN</sub>) and Pin 2 (C<sub>XOUT</sub>). C<sub>XIN</sub> always equals C<sub>XOUT</sub>, and they are

programmable from 12 pF to 60 pF, in 0.5 pF increments. This feature eliminates the need for external crystal load capacitors.

The following formula is used to calculate the value of C<sub>XIN</sub> and C<sub>XOUT</sub> for matching the crystal load (C<sub>L</sub>):

$$C_{XIN} = C_{XOUT} = 2C_L - C_P$$

where C<sub>L</sub> is the crystal load capacitor as specified by the crystal manufacturer and C<sub>P</sub> is the parasitic PCB capacitance on each node of the crystal.

For example, if a crystal with C<sub>L</sub> of 16 pF is used, and C<sub>P</sub> is 2 pF, C<sub>XIN</sub> and C<sub>XOUT</sub> are calculated as:

$$C_{XIN} = C_{XOUT} = (2 \times 16) - 2 = 30 \text{ pF}$$

If using a driven reference, set C<sub>XIN</sub> and C<sub>XOUT</sub> to the minimum value 12 pF, connect the reference to XIN/CLKIN, and leave XOUT unconnected.

### Output Frequency (SSCLK, Pin 7)

The modulated frequency at the SSCLK output is produced by synthesizing the input reference clock. The modulation can be stopped by SSON# digital control input (SSON# = HIGH, no modulation). If modulation is stopped, the clock frequency is the nominal value of the synthesized frequency without modulation (spread percentage = 0). The range of synthesized clock is from 3 to 200 MHz.

### Spread Percentage (SSCLK, Pin 7)

The SSCLK spread can be programmed at any percentage value from ±0.25% to ±2.5% for center spread and from -0.5% to -5.0% for down spread.

### Reference Output (REFOUT, Pin 6)

The reference clock output has the same frequency and the same phase as the input clock. This output can be programmed to be enabled (clock on) or disabled (High Z, clock off). If this output is not required, it is recommended that the disabled (High Z, Clock Off) option be selected.

### Modulation Frequency

The modulation frequency is 31.5 kHz for all SSCLK frequencies from 3 to 200 MHz.

### Power Down or Output Enable (PD# or OE, Pin 4)

The part can be programmed to include either PD# or OE function. PD# function powers down the oscillator and PLL. The OE function disables the outputs.

### Absolute Maximum Ratings

Supply Voltage ( $V_{DD}$ )	-0.5 to +7.0 V	Junction Temperature	-40 °C to +125 °C
DC Input Voltage	-0.5 V to $V_{DD} + 0.5$ V	Data Retention at $T_j = 125$ °C	> 10 years
Storage Temperature (Non condensing)	-55 °C to +125 °C	Package Power Dissipation	350 mW
		Static Discharge Voltage (per MIL-STD-883, Method 3015)	$\geq 2000$ V

### Recommended Crystal Specifications

Parameter	Description	Comments	Min	Typ	Max	Unit
$f_{NOM}$	Nominal Crystal Frequency	Parallel resonance, fundamental mode, AT cut	8	-	30	MHz
$C_{LNOM}$	Nominal Load Capacitance	Internal load caps	6	-	30	pF
$R_1$	Equivalent Series Resistance (ESR)	Fundamental mode	-	-	25	$\Omega$
$R_3/R_1$	Ratio of Third Overtone Mode ESR to Fundamental Mode ESR	Ratio used because typical $R_1$ values are much less than the maximum spec	3	-	-	-
DL	Crystal Drive Level	No external series resistor assumed	-	0.5	2	mW

### Operating Conditions

Parameter	Description	Min	Typ	Max	Unit
$V_{DD}$	Supply Voltage	3.13	3.30	3.45	V
$T_A$	Ambient Commercial Temperature	0	-	70	°C
	Ambient Industrial Temperature	-40	-	85	°C
$C_{LOAD}$	Maximum Load Capacitance at Pin 6 and Pin 7	-	-	15	pF
$f_{REF}$	External Reference Crystal (Fundamental tuned crystals only)	8	-	30	MHz
	External Reference Clock	8	-	166	MHz
$f_{SSCLK}$	SSCLK Output Frequency, $C_{LOAD} = 15$ pF	3	-	200	MHz
$f_{REFCLK}$	REFCLK Output Frequency, $C_{LOAD} = 15$ pF	8	-	166	MHz
$f_{MOD}$	Spread Spectrum Modulation Frequency	30.0	31.5	33.0	kHz
$t_{PU}$	Power Up Time for all $V_{DD}$ 's to reach minimum specified voltage (power ramp must be monotonic)	0.05	-	500	ms

## DC Electrical Characteristics

Parameter	Description	Condition	Min	Typ	Max	Unit
$I_{OH}$	Output High Current	$V_{OH} = V_{DD} - 0.5 \text{ V}$ , $V_{DD} = 3.3 \text{ V}$ (source)	10	12	–	mA
$I_{OL}$	Output Low Current	$V_{OL} = 0.5 \text{ V}$ , $V_{DD} = 3.3 \text{ V}$ (sink)	10	12	–	mA
$V_{IH}$	Input High Voltage	CMOS levels, 70% of $V_{DD}$	$0.7 \times V_{DD}$	–	$V_{DD}$	V
$V_{IL}$	Input Low Voltage	CMOS levels, 30% of $V_{DD}$	–	–	$0.3 \times V_{DD}$	V
$I_{IH}$	Input High Current, PD#/OE and SSON# Pins	$V_{in} = V_{DD}$	–10	–	10	$\mu\text{A}$
$I_{IL}$	Input Low Current, PD#/OE and SSON# Pins	$V_{in} = V_{SS}$	–10	–	10	$\mu\text{A}$
$I_{OZ}$	Output Leakage Current	Three-state output, PD#/OE = 0, output pulldown resistor disabled	–10	–	10	$\mu\text{A}$
$C_{XIN}$ or $C_{XOUT}$ <sup>[1]</sup>	Programmable Capacitance at Pin 2 and Pin 3	Capacitance at minimum setting	–	12	–	pF
		Capacitance at maximum setting	–	60	–	pF
$C_{IN}$ <sup>[1]</sup>	Input Capacitance at Pin 4 and Pin 8	Input pins excluding XIN and XOUT	–	5	7	pF
$I_{VDD}$	Supply Current	$V_{DD} = 3.45 \text{ V}$ , $F_{in} = 30 \text{ MHz}$ , $REFCLK = 30 \text{ MHz}$ , $SSCLK = 66 \text{ MHz}$ , $C_{LOAD} = 15 \text{ pF}$ , PD#/OE = SSON# = $V_{DD}$	–	25	35	mA
$I_{DDs}$	Standby Current	$V_{DD} = 3.45 \text{ V}$ , Device powered down with PD# = 0 V (driven reference pulled down)	–	15	30	$\mu\text{A}$

## Thermal Resistance

Parameter <sup>[2]</sup>	Description	Test Conditions	8-pin SOIC	8-pin TSSOP	Unit
$\theta_{JA}$	Thermal resistance (junction to ambient)	Test conditions follow standard test methods and procedures for measuring thermal impedance, in accordance with EIA/JESD51.	134	161	$^{\circ}\text{C/W}$
$\theta_{JC}$	Thermal resistance (junction to case)		49	31	$^{\circ}\text{C/W}$

### Notes

1. Guaranteed by characterization, not 100% tested.
2. These parameters are guaranteed by design and are not tested.

## Application Circuit

Figure 2. Application Circuit Diagram [3, 4, 5]

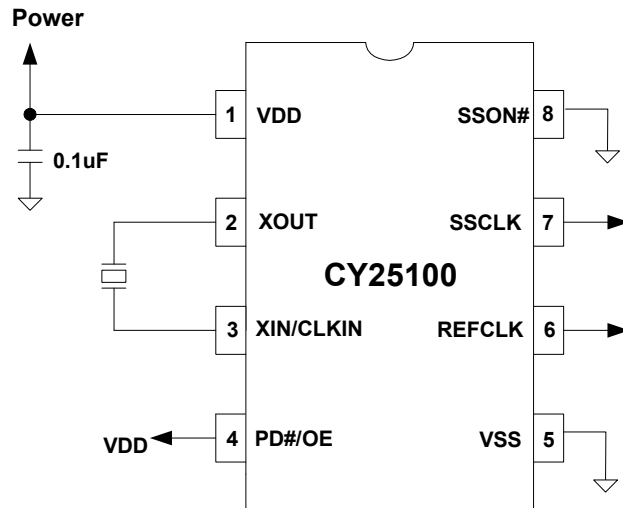

### Notes

3. Because the load capacitors ( $C_{XIN}$  and  $C_{XOUT}$ ) are provided by the CY25100, no external capacitors are needed on the  $X_{IN}$  and  $X_{OUT}$  pins to match the crystal load capacitor ( $C_L$ ). Only a single 0.1-µF bypass capacitor is required on the  $V_{DD}$  pin.
4. If an external clock is used, apply the clock to  $X_{IN}$  (pin 3) and leave  $X_{OUT}$  (pin 2) floating (unconnected).
5. If  $SSON\#$  (pin 8) is LOW ( $V_{SS}$ ), the frequency modulation is on at  $SSCLK$  (pin 7).

## AC Electrical Characteristics

The AC Electrical Characteristics for part CY25100 is as follows. <sup>[6]</sup>

Parameter	Description	Condition	Min	Typ	Max	Unit
DC	Output Duty Cycle	SSCLK, Measured at $V_{DD}/2$	45	50	55	%
	Output Duty Cycle	REFCLK, Measured at $V_{DD}/2$ , Duty Cycle of CLKIN = 50% at input bias	40	50	60	%
SR1	Rising Edge Slew Rate	SSCLK from 3 to 100 MHz; REFCLK from 3 to 100 MHz; 20%–80% of $V_{DD}$	0.7	1.1	3.6	V/ns
SR2	Falling Edge Slew Rate	SSCLK from 3 to 100 MHz; REFCLK from 3 to 100 MHz; 80%–20% of $V_{DD}$	0.7	1.1	3.6	V/ns
SR3	Rising Edge Slew Rate	SSCLK from 100 to 200 MHz; REFCLK from 100 to 166 MHz; 20%–80% of $V_{DD}$	1.0	1.6	4.0	V/ns
SR4	Falling Edge Slew Rate	SSCLK from 100 to 200 MHz; REFCLK from 100 to 166 MHz; 80%–20% of $V_{DD}$	1.2	1.6	4.0	V/ns
$t_{CCJ1}$ <sup>[7]</sup>	Cycle-to-Cycle Jitter, SSCLK (Pin 7)	CLKIN = SSCLK = 166 MHz, 2% spread, REFCLK off	–	90	120	ps
		CLKIN = SSCLK = 66 MHz, 2% spread, REFCLK off	–	100	130	ps
		CLKIN = SSCLK = 33 MHz, 2% spread, REFCLK off	–	130	170	ps
$t_{CCJ2}$ <sup>[7]</sup>	Cycle-to-Cycle Jitter, SSCLK (Pin 7)	CLKIN = SSCLK = 166 MHz, 2% spread, REFCLK on	–	100	130	ps
		CLKIN = SSCLK = 66 MHz, 2% spread, REFCLK on	–	105	140	ps
		CLKIN = SSCLK = 33 MHz, 2% spread, REFCLK on	–	200	260	ps
$t_{CCJ3}$ <sup>[7]</sup>	Cycle-to-Cycle Jitter, REFCLK (Pin 6)	CLKIN = SSCLK = 166 MHz, 2% spread, REFCLK on	–	80	100	ps
		CLKIN = SSCLK = 66 MHz, 2% spread, REFCLK on	–	100	130	ps
		CLKIN = SSCLK = 33 MHz, 2% spread, REFCLK on	–	135	180	ps
$t_{STP}$	Power down Time (pin 4 = PD#)	Time from falling edge on PD# to stopped outputs (Asynchronous)	–	150	350	ns
$t_{OE1}$	Output Disable Time (pin 4 = OE)	Time from falling edge on OE to stopped outputs (Asynchronous)	–	150	350	ns
$t_{OE2}$	Output Enable Time (pin 4 = OE)	Time from rising edge on OE to outputs at a valid frequency (Asynchronous)	–	150	350	ns
$t_{PU1}$	Power Up Time, Crystal is used	Time from rising edge on PD# to outputs at valid frequency (Asynchronous)	–	3.5	5	ms
$t_{PU2}$	Power Up Time, Reference clock is used	Time from rising edge on PD# to outputs at valid frequency (Asynchronous), reference clock at correct frequency	–	2	3	ms

### Notes

- Guaranteed by characterization, not 100% tested.
- Jitter is configuration dependent. Actual jitter is dependent on XIN jitter and edge rate, number of active outputs, output frequencies, spread percentage, temperature, and output load.



### Switching Waveforms

Figure 3. Duty Cycle Timing ( $DC = t_{1A}/t_{1B}$ )

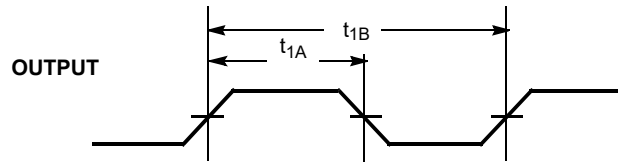
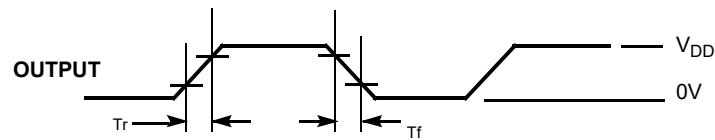

Figure 4. Output Rise/Fall Time (SSCLK and REFCLK)



Output Rise time ( $T_r$ ) =  $(0.6 \times V_{DD})/SR1$  (or  $SR3$ )  
 Output Fall time ( $T_f$ ) =  $(0.6 \times V_{DD})/SR2$  (or  $SR4$ )

Refer to AC Electrical Characteristics table for SR (Slew Rate) values.

Figure 5. Power Down and Power Up Timing

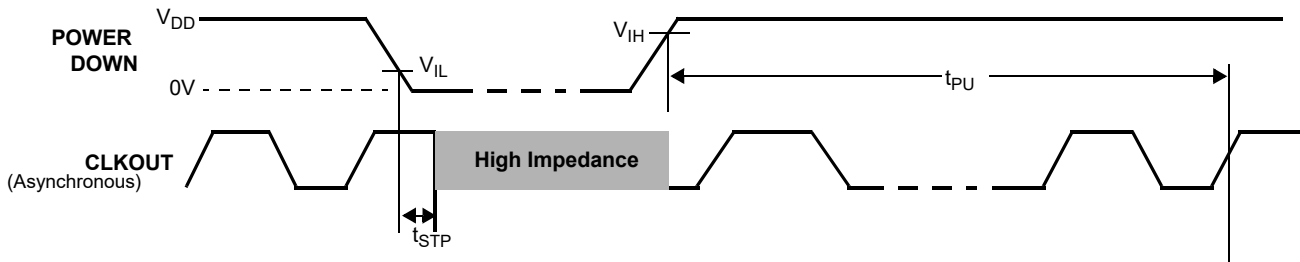
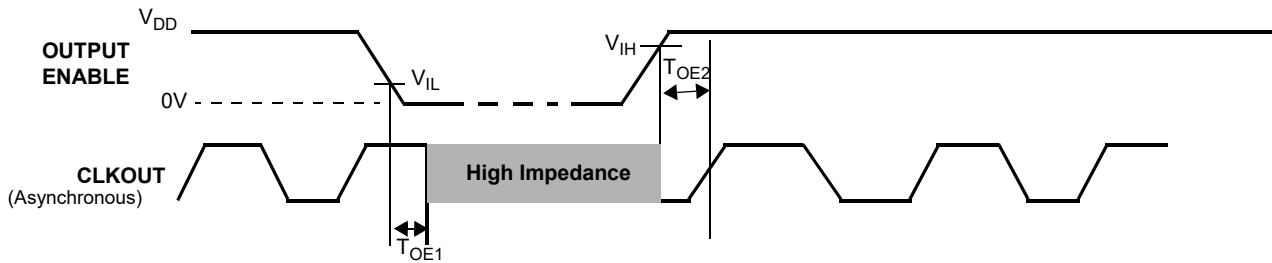
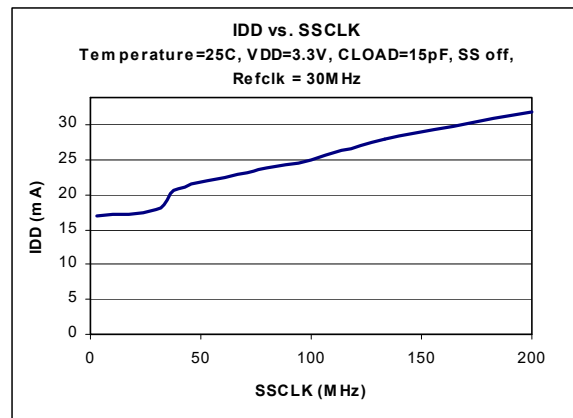
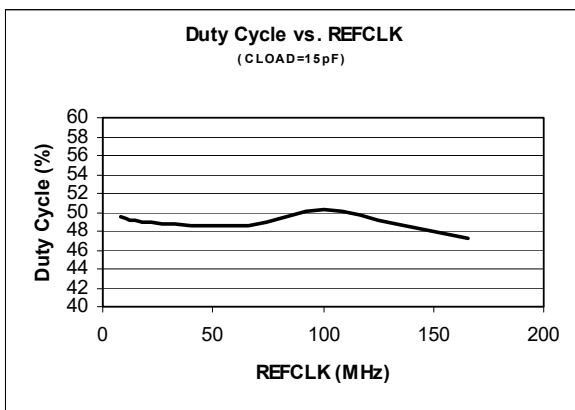
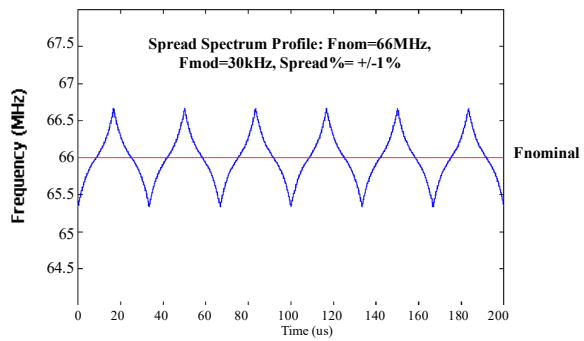
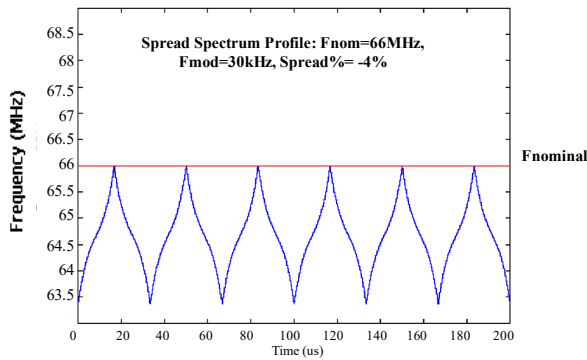
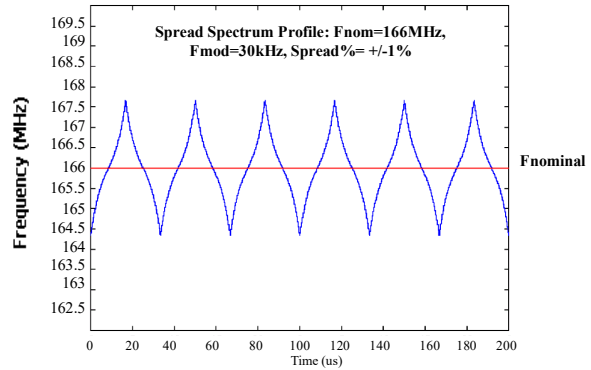
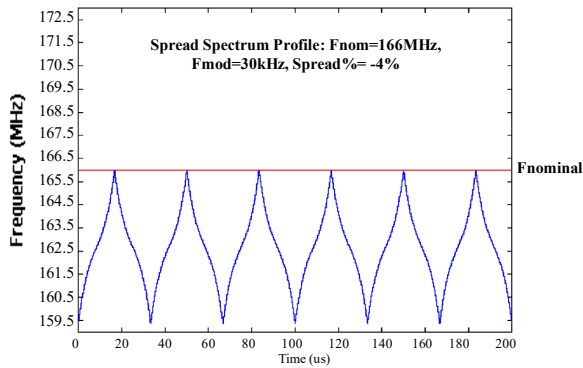

Figure 6. Output Enable/Disable Timing



## Informational Graphs

The Informational Graphs are as follows. [8]



### Note

8. The Informational Graphs are meant to convey the typical performance levels. No performance specifications is implied or guaranteed. Refer to [DC Electrical Characteristics on page 6](#) and [AC Electrical Characteristics on page 8](#) for device specifications.

**Informational Graphs** (continued)

The Informational Graphs are as follows. [8]

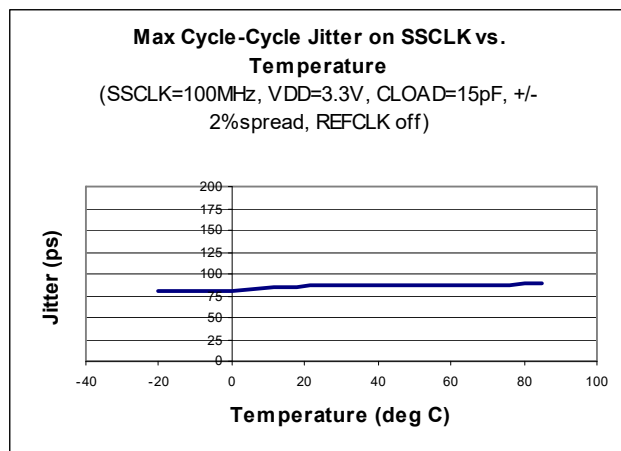
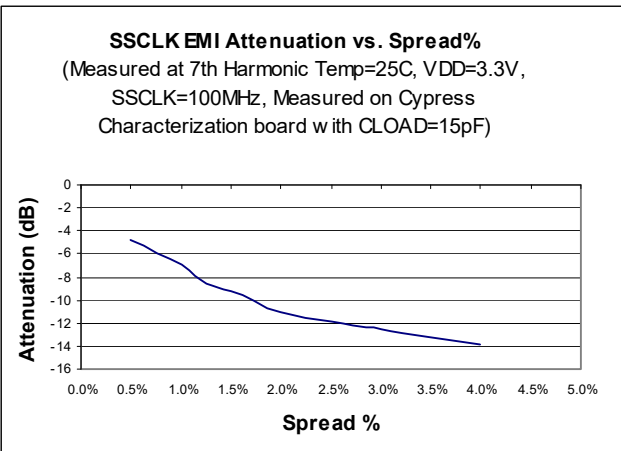
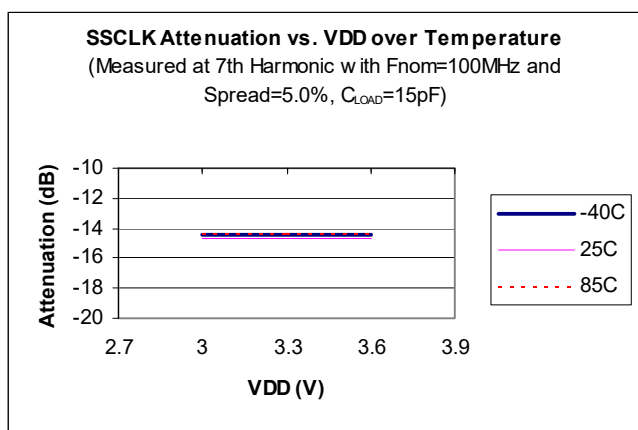
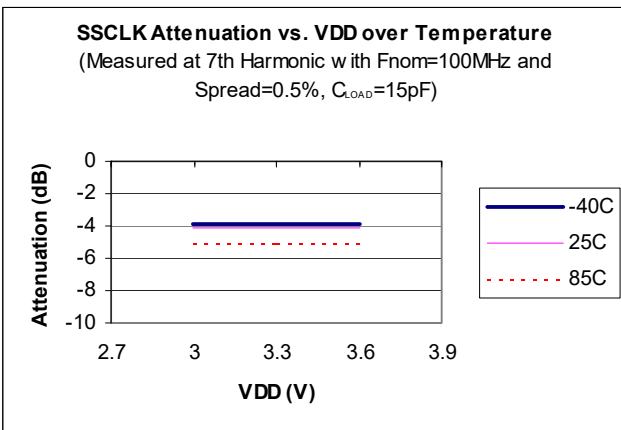
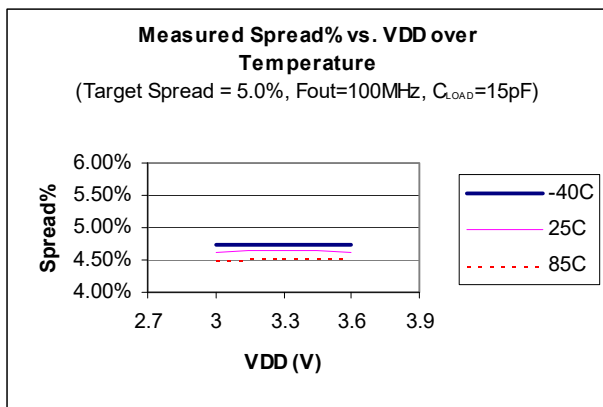
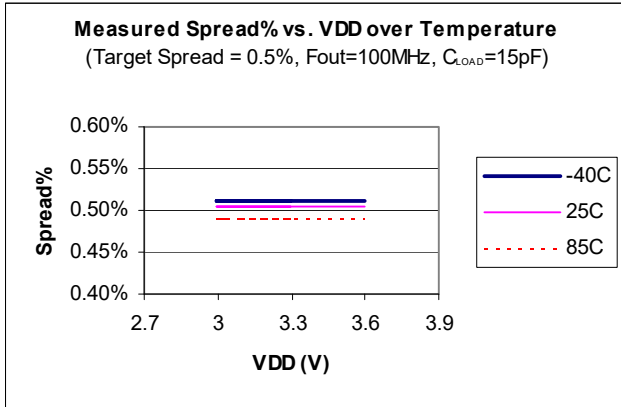

## Ordering Information

Ordering Code	Package Description	Product Flow
<b>Pb-free</b>		
CY25100SXCF	8-pin SOIC	Commercial, 0 °C to 70 °C
CY25100SXCFT	8-pin SOIC – Tape and Reel	Commercial, 0 °C to 70 °C
CY25100SXIF	8-pin SOIC	Industrial, –40 °C to 85 °C
CY25100SXIFT	8-pin SOIC – Tape and Reel	Industrial, –40 °C to 85 °C
CY25100ZXCF	8-pin TSSOP	Commercial, 0 °C to 70 °C
CY25100ZXCFT	8-pin TSSOP – Tape and Reel	Commercial, 0 °C to 70 °C
CY25100ZXIF	8-pin TSSOP	Industrial, –40 °C to 85 °C
CY25100ZXIFT	8-pin TSSOP – Tape and Reel	Industrial, –40 °C to 85 °C
<b>Programmer</b>		
CY3675-CLKMAKER1	Programmer	

Some product offerings are factory programmed customer specific devices with customized part numbers. The Possible Configurations table shows the available device types, but not complete part numbers. Contact your local Cypress FAE or Sales Representative for more information.

## Possible Configurations

Ordering Code	Package Description	Product Flow
CY25100Zlxxx <sup>[9, 10]</sup>	8-pin TSSOP	Industrial, –40 °C to 85 °C
CY25100ZlxxxT <sup>[9, 10]</sup>	8-pin TSSOP – Tape and Reel	Industrial, –40 °C to 85 °C
<b>Pb-free</b>		
CY25100SXCxx <sup>[9]</sup>	8-pin SOIC	Commercial, 0 °C to 70 °C
CY25100SXCxxT <sup>[9]</sup>	8-pin SOIC – Tape and Reel	Commercial, 0 °C to 70 °C
CY25100SXlxxx <sup>[9]</sup>	8-pin SOIC	Industrial, –40 °C to 85 °C
CY25100SXlxxxT <sup>[9]</sup>	8-pin SOIC – Tape and Reel	Industrial, –40 °C to 85 °C
CY25100ZXCxx <sup>[9]</sup>	8-pin TSSOP	Commercial, 0 °C to 70 °C
CY25100ZXCxxT <sup>[9]</sup>	8-pin TSSOP – Tape and Reel	Commercial, 0 °C to 70 °C
CY25100Zxlxx <sup>[9]</sup>	8-pin TSSOP	Industrial, –40 °C to 85 °C
CY25100ZxlxxT <sup>[9]</sup>	8-pin TSSOP – Tape and Reel	Industrial, –40 °C to 85 °C

### Note

9. Ordering codes with "xxx" or "xx" are factory-programmed configurations. "xxx" or "xx" denotes the specific device configuration. "w" denotes the revision. Factory programming is available for high-volume orders. For more details, contact your local Cypress field application engineer or Cypress Sales Representative.

10. Not recommended for new designs. New designs should use Pb-free devices.

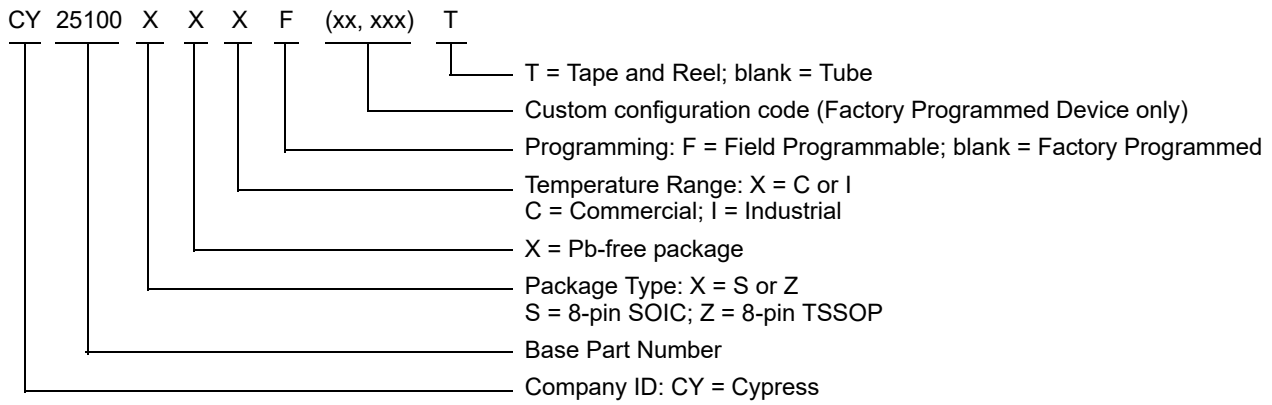
**Ordering Code Definitions**

### Package Diagrams

Figure 7. 8-pin SOIC (150 Mils) S08.15/SZ08.15/SW815 Package Outline, 51-85066

1. DIMENSIONS IN INCHES[MM] MIN. MAX.
2. PIN 1 ID IS OPTIONAL, ROUND ON SINGLE LEADFRAME RECTANGULAR ON MATRIX LEADFRAME
3. REFERENCE JEDEC MS-012
4. PACKAGE WEIGHT 0.07gms

PART #	
S08.15	STANDARD PKG
SZ08.15	LEAD FREE PKG
SW8.15	LEAD FREE PKG

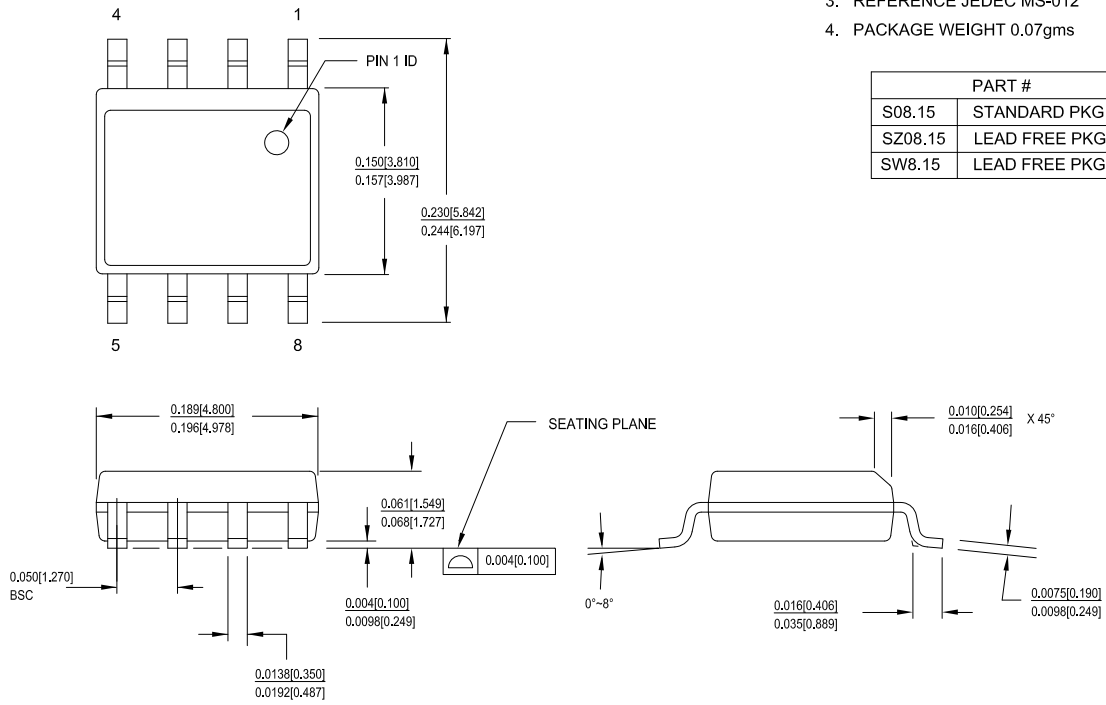

51-85066 \*I

Package Diagrams (continued)

Figure 7. 8-pin TSSOP (4.40 mm Body) Z08.173/ZZ08.173 Package Outline, 51-85093

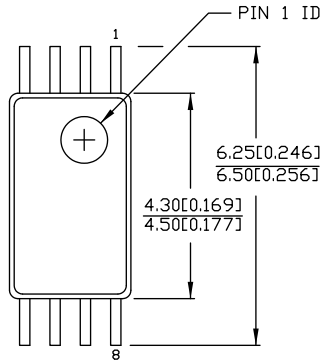

DIMENSIONS IN MM [INCHES] MIN.  
MAX.

REFERENCE JEDEC MO-153

PART #	
Z08.173	STANDARD PKG.
ZZ08.173	LEAD FREE PKG.

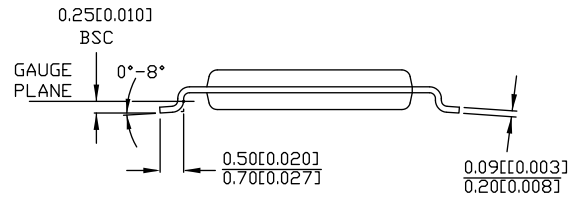
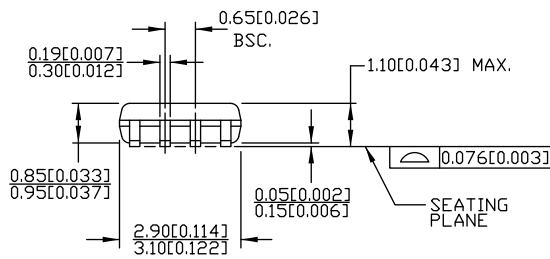

51-85093 \*E

## Acronyms

Acronym	Description
DC	Direct Current
EMI	Electromagnetic Interference
ESR	Equivalent Series Resistance
FAE	Field Application Engineer
JEDEC	Joint Electron Devices Engineering Council
OE	Output Enable
PCB	Printed Circuit Board
PD	Power Down
PLL	Phase Locked Loop
SOIC	Small Outline Integrated Circuit
SSC	Spread Spectrum Clock
SSCG	Spread Spectrum Clock Generator
TSSOP	Thin Shrunk Small Outline Package

## Document Conventions

### Units of Measure

Symbol	Unit of Measure
°C	degree Celsius
kHz	kilohertz
MHz	megahertz
μA	microampere
μF	microfarad
mA	milliampere
mm	millimeter
ms	millisecond
mW	milliwatt
ns	nanosecond
Ω	ohm
%	percent
pF	picofarad
ps	picosecond
V	volt



## Document History Page

Document Title: CY25100, Field and Factory Programmable Spread Spectrum Clock Generator for EMI Reduction Document Number: 38-07499				
Rev.	ECN No.	Orig. of Change	Submission Date	Description of Change
**	126578	CKN	06/27/2003	New data sheet.
*A	128753	IJATMP	08/29/2003	Updated <a href="#">Programming Description</a> : Added <a href="#">Field Programmable CY25100</a> . Added CyberClocks™ Online Software. Added <a href="#">CY3672 Programmer and CY3690/CY3691 Socket Adapters</a> . Added <a href="#">Factory Programmable CY25100</a> . Removed "Custom Configuration Request Procedure". Updated <a href="#">Ordering Information</a> : Updated part numbers. Added Note 9 and referred the same note in "Part Number" column.
*B	130342	RGL	12/02/2003	Updated <a href="#">Application Circuit</a> : Updated <a href="#">Figure 2</a> . Updated <a href="#">Ordering Information</a> : No change in part numbers. Updated details in "Package Description" column corresponding to MPNs CY3690 and CY3691. Updated <a href="#">Package Diagrams</a> : spec 51-85066 – Changed revision from *B to *C. spec 51-85093 – Changed revision from ** to *A.
*C	204121	RGL	02/11/2004	Added Industrial Temperature Range related information in all instances across the document. Updated <a href="#">Ordering Information</a> : Updated part numbers. Updated Note 9.
*D	215392	RGL	03/31/2004	Updated <a href="#">Ordering Information</a> : Updated part numbers.
*E	2513909	AESA	06/10/2008	Updated <a href="#">Ordering Information</a> : Updated part numbers. Replaced "Lead free" with "Pb-Free". Added Note 10 and referred the same note in corresponding MPNs. Added "Pb-Free" in header. Updated details in "Package Description" column (Removed Pb-Free). Updated to new template.
*F	2601881	KVM / PYRS	11/06/2008	Updated <a href="#">AC Electrical Characteristics</a> : Changed minimum value of SR3 parameter from 1.2 V/ns to 1.0 V/ns. Updated <a href="#">Ordering Information</a> : Updated part numbers. Removed reference of Note 9 from Parameter column. Referred Note 9 in 'xxx' parts.
*G	2742910	KVM	07/23/2009	General text cleanup across the document. Replaced "CY3672 FTG" with "CY3672" in all instances across the document. Removed "Benefits". Updated <a href="#">Pin Description</a> : Added a column "Type" and added corresponding details of all pins. Updated <a href="#">Programming Description</a> : Updated CyberClocks™ Online Software: Updated description. Updated <a href="#">Product Functions</a> : Updated <a href="#">Modulation Frequency</a> : Updated description.

**Document History Page** (continued)

Document Title: CY25100, Field and Factory Programmable Spread Spectrum Clock Generator for EMI Reduction Document Number: 38-07499				
Rev.	ECN No.	Orig. of Change	Submission Date	Description of Change
*G (cont.)	2742910	KVM	07/23/2009	Updated <a href="#">DC Electrical Characteristics</a> : Added minimum values for I <sub>IH</sub> and I <sub>IL</sub> parameters. Updated details in "Condition" column corresponding to I <sub>OZ</sub> parameter. Updated <a href="#">AC Electrical Characteristics</a> : Standardized timing parameter names to upper case in "Parameter" column. Updated <a href="#">Ordering Information</a> : Updated part numbers. Updated Note 9. Updated Note 10.
*H	2897317	KVM	03/22/2010	Updated <a href="#">Ordering Information</a> : Updated part numbers. Added <a href="#">Possible Configurations</a> : Moved 'xxx' parts under Possible Configurations. Updated <a href="#">Package Diagrams</a> : spec 51-85066 – Changed revision from *C to *D. spec 51-85093 – Changed revision from *A to *B.
*I	3366141	PURU	09/12/2011	Updated <a href="#">Logic Block Diagram</a> . Updated <a href="#">Ordering Information</a> : No change in part numbers. Added <a href="#">Ordering Code Definitions</a> . Updated <a href="#">Package Diagrams</a> : spec 51-85066 – Changed revision from *D to *E. spec 51-85093 – Changed revision from *B to *C. Added <a href="#">Acronyms</a> and <a href="#">Units of Measure</a> . Updated to new template. Completing Sunset Review.
*J	4108421	CINM	08/30/2013	Updated <a href="#">Package Diagrams</a> : spec 51-85066 – Changed revision from *E to *F. spec 51-85093 – Changed revision from *C to *D. Updated to new template. Completing Sunset Review.
*K	4581659	TAVA	11/28/2014	Updated <a href="#">Functional Description</a> : Added "For a complete list of related documentation, click <a href="#">here</a> ." at the end. Updated <a href="#">Package Diagrams</a> : spec 51-85093 – Changed revision from *D to *E.
*L	5516747	PSR / PAWK	11/10/2016	Updated <a href="#">Programming Description</a> : Removed "CyberClocks™ Online Software". Added <a href="#">Thermal Resistance</a> . Updated <a href="#">Package Diagrams</a> : spec 51-85066 – Changed revision from *F to *H. Updated to new template. Completing Sunset Review.
*M	6015682	PAWK	02/01/2018	Updated <a href="#">Ordering Information</a> : Updated part numbers. Updated <a href="#">Package Diagrams</a> : spec 51-85066 – Changed revision from *H to *I. Updated to new template.

## Sales, Solutions, and Legal Information

### Worldwide Sales and Design Support

Cypress maintains a worldwide network of offices, solution centers, manufacturer's representatives, and distributors. To find the office closest to you, visit us at [Cypress Locations](#).

#### Products

Arm® Cortex® Microcontrollers	<a href="http://cypress.com/arm">cypress.com/arm</a>
Automotive	<a href="http://cypress.com/automotive">cypress.com/automotive</a>
Clocks & Buffers	<a href="http://cypress.com/clocks">cypress.com/clocks</a>
Interface	<a href="http://cypress.com/interface">cypress.com/interface</a>
Internet of Things	<a href="http://cypress.com/iot">cypress.com/iot</a>
Memory	<a href="http://cypress.com/memory">cypress.com/memory</a>
Microcontrollers	<a href="http://cypress.com/mcu">cypress.com/mcu</a>
PSoC	<a href="http://cypress.com/psoc">cypress.com/psoc</a>
Power Management ICs	<a href="http://cypress.com/pmic">cypress.com/pmic</a>
Touch Sensing	<a href="http://cypress.com/touch">cypress.com/touch</a>
USB Controllers	<a href="http://cypress.com/usb">cypress.com/usb</a>
Wireless Connectivity	<a href="http://cypress.com/wireless">cypress.com/wireless</a>

#### PSoC® Solutions

[PSoC 1](#) | [PSoC 3](#) | [PSoC 4](#) | [PSoC 5LP](#) | [PSoC 6 MCU](#)

#### Cypress Developer Community

[Community](#) | [Projects](#) | [Video](#) | [Blogs](#) | [Training](#) | [Components](#)

#### Technical Support

[cypress.com/support](http://cypress.com/support)

---

© Cypress Semiconductor Corporation, 2003-2018. This document is the property of Cypress Semiconductor Corporation and its subsidiaries, including Spansion LLC ("Cypress"). This document, including any software or firmware included or referenced in this document ("Software"), is owned by Cypress under the intellectual property laws and treaties of the United States and other countries worldwide. Cypress reserves all rights under such laws and treaties and does not, except as specifically stated in this paragraph, grant any license under its patents, copyrights, trademarks, or other intellectual property rights. If the Software is not accompanied by a license agreement and you do not otherwise have a written agreement with Cypress governing the use of the Software, then Cypress hereby grants you a personal, non-exclusive, nontransferable license (without the right to sublicense) (1) under its copyright rights in the Software (a) for Software provided in source code form, to modify and reproduce the Software solely for use with Cypress hardware products, only internally within your organization, and (b) to distribute the Software in binary code form externally to end users (either directly or indirectly through resellers and distributors), solely for use on Cypress hardware product units, and (2) under those claims of Cypress's patents that are infringed by the Software (as provided by Cypress, unmodified) to make, use, distribute, and import the Software solely for use with Cypress hardware products. Any other use, reproduction, modification, translation, or compilation of the Software is prohibited.

TO THE EXTENT PERMITTED BY APPLICABLE LAW, CYPRESS MAKES NO WARRANTY OF ANY KIND, EXPRESS OR IMPLIED, WITH REGARD TO THIS DOCUMENT OR ANY SOFTWARE OR ACCOMPANYING HARDWARE, INCLUDING, BUT NOT LIMITED TO, THE IMPLIED WARRANTIES OF MERCHANTABILITY AND FITNESS FOR A PARTICULAR PURPOSE. To the extent permitted by applicable law, Cypress reserves the right to make changes to this document without further notice. Cypress does not assume any liability arising out of the application or use of any product or circuit described in this document. Any information provided in this document, including any sample design information or programming code, is provided only for reference purposes. It is the responsibility of the user of this document to properly design, program, and test the functionality and safety of any application made of this information and any resulting product. Cypress products are not designed, intended, or authorized for use as critical components in systems designed or intended for the operation of weapons, weapons systems, nuclear installations, life-support devices or systems, other medical devices or systems (including resuscitation equipment and surgical implants), pollution control or hazardous substances management, or other uses where the failure of the device or system could cause personal injury, death, or property damage ("Unintended Uses"). A critical component is any component of a device or system whose failure to perform can be reasonably expected to cause the failure of the device or system, or to affect its safety or effectiveness. Cypress is not liable, in whole or in part, and you shall and hereby do release Cypress from any claim, damage, or other liability arising from or related to all Unintended Uses of Cypress products. You shall indemnify and hold Cypress harmless from and against all claims, costs, damages, and other liabilities, including claims for personal injury or death, arising from or related to any Unintended Uses of Cypress products.

Cypress, the Cypress logo, Spansion, the Spansion logo, and combinations thereof, WICED, PSoC, CapSense, EZ-USB, F-RAM, and Traveo are trademarks or registered trademarks of Cypress in the United States and other countries. For a more complete list of Cypress trademarks, visit [cypress.com](http://cypress.com). Other names and brands may be claimed as property of their respective owners.

Компания «Океан Электроники» предлагает заключение долгосрочных отношений при поставках импортных электронных компонентов на взаимовыгодных условиях!

Наши преимущества:

- Поставка оригинальных импортных электронных компонентов напрямую с производств Америки, Европы и Азии, а так же с крупнейших складов мира;
- Широкая линейка поставок активных и пассивных импортных электронных компонентов (более 30 млн. наименований);
- Поставка сложных, дефицитных, либо снятых с производства позиций;
- Оперативные сроки поставки под заказ (от 5 рабочих дней);
- Экспресс доставка в любую точку России;
- Помощь Конструкторского Отдела и консультации квалифицированных инженеров;
- Техническая поддержка проекта, помощь в подборе аналогов, поставка прототипов;
- Поставка электронных компонентов под контролем ВП;
- Система менеджмента качества сертифицирована по Международному стандарту ISO 9001;
- При необходимости вся продукция военного и аэрокосмического назначения проходит испытания и сертификацию в лаборатории (по согласованию с заказчиком);
- Поставка специализированных компонентов военного и аэрокосмического уровня качества (Xilinx, Altera, Analog Devices, Intersil, Interpoint, Microsemi, Actel, Aeroflex, Peregrine, VPT, Syfer, Eurofarad, Texas Instruments, MS Kennedy, Miteq, Cobham, E2V, MA-COM, Hittite, Mini-Circuits, General Dynamics и др.);

Компания «Океан Электроники» является официальным дистрибьютором и эксклюзивным представителем в России одного из крупнейших производителей разъемов военного и аэрокосмического назначения «JONHON», а так же официальным дистрибьютором и эксклюзивным представителем в России производителя высокотехнологичных и надежных решений для передачи СВЧ сигналов «FORSTAR».



## JONHON

«JONHON» (основан в 1970 г.)

Разъемы специального, военного и аэрокосмического назначения:

(Применяются в военной, авиационной, аэрокосмической, морской, железнодорожной, горно- и нефтедобывающей отраслях промышленности)

«FORSTAR» (основан в 1998 г.)

ВЧ соединители, коаксиальные кабели, кабельные сборки и микроволновые компоненты:

(Применяются в телекоммуникациях гражданского и специального назначения, в средствах связи, РЛС, а так же военной, авиационной и аэрокосмической отраслях промышленности).



Телефон: 8 (812) 309-75-97 (многоканальный)

Факс: 8 (812) 320-03-32

Электронная почта: [ocean@oceanchips.ru](mailto:ocean@oceanchips.ru)

Web: <http://oceanchips.ru/>

Адрес: 198099, г. Санкт-Петербург, ул. Калинина, д. 2, корп. 4, лит. А