

# SERIES 100 SWITCHES

## TOGGLE SWITCHES - MINIATURE

c **RL** us

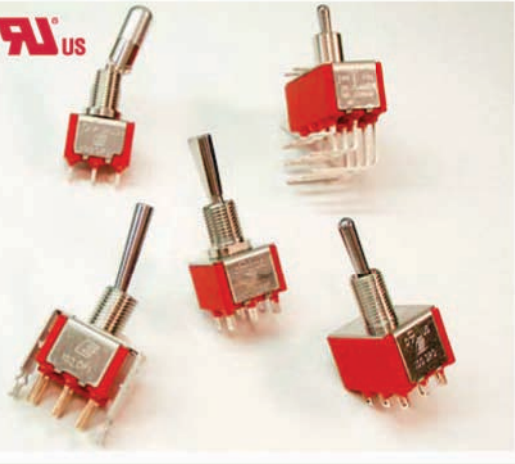

### SPECIFICATIONS

Contact Rating:	See contact material options
Life Expectancy:	40,000 make-and-break cycles
Contact Resistance:	10 mΩ max. typical initial @ 2-4 VDC 100 mA for both silver and gold plated contacts
Insulation Resistance:	1,000 MΩ min.
Dielectric Strength:	1,000 V RMS @ sea level
Operating Temperature:	-30° C to 85° C

### MATERIALS

Case:	Diallyl Phthalate (DAP)
Toggle Handle:	Brass, chrome plated
Switch Support:	Brass or steel, tin plated
Bushing:	Brass, nickel plated
Housing:	Stainless steel
Contacts / Terminals:	Silver or gold plated copper alloy

### FEATURES & BENEFITS

- ▶ Up to 4 poles available
- ▶ Variety of switching functions
- ▶ Miniature
- ▶ Multiple actuator & bushing options

### APPLICATIONS/MARKETS

- ▶ Telecommunications
- ▶ Instrumentation
- ▶ Networking
- ▶ Medical equipment

### HOW TO ORDER

SERIES 100	MODEL NO.	ACTUATOR	BUSHING	TERMINATION	CONTACT MATERIAL	SEAL	HARDWARE
	SP1	T1†	B1	M1	Q = Silver R = Gold	E = Epoxy Sealed at Base of Terminal	H = Hardware
	SP2*	T2	B2	M2			
	SP3	T3	B3	M3			
	SP4*	T4	B4	M5			
	SP5*	T5	B5	M6			
	DP1	T6	B6	M61			
	DP2*	T7	B8	M7			
	DP3	T8	B9	M71			
	DP4*	T9	B11	VS2			
	DP5*	K1	B12	VS3			
	DP6	K2	B13	VS5*			
	DP7*		B15	M64*			
	DP8*	† Optional Toggle Cap (T1 Only): T100-1 = White T100-2 = Black	B16	VS21*			
	3P1		B25**	VS31*			
	3P2*		B26**				
	3P3						
	3P4*						
	3P5*						
	4P1						
	4P2*						
	4P3						
	4P4*						
	4P5*						
	4P6						
	4P7*						
	4P8*						

▶ ▶ ▶ Example Ordering Number  
100-SP1-T4-B2-M1-R-E

Notes: \* Not available with the K1 and K2 actuator options.

\*\* Available only with the K1 and K2 actuator options.

Specifications subject to change without notice.



### SPDT



SCHEMATIC

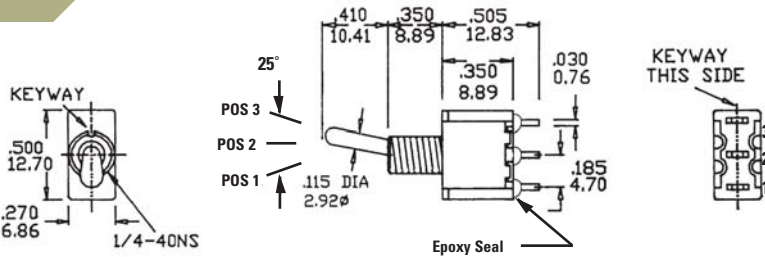

Model No.	POS 1	POS 2	POS 3
SP-1	ON	NONE	ON
SP-2	ON	NONE	(ON)
SP-3	ON	OFF	ON
SP-4	(ON)	OFF	(ON)
SP-5	ON	OFF	(ON)
Term. Comm.	2-3	OPEN	2-1

( ) = Momentary

### DPDT

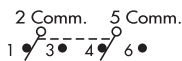

SCHEMATIC

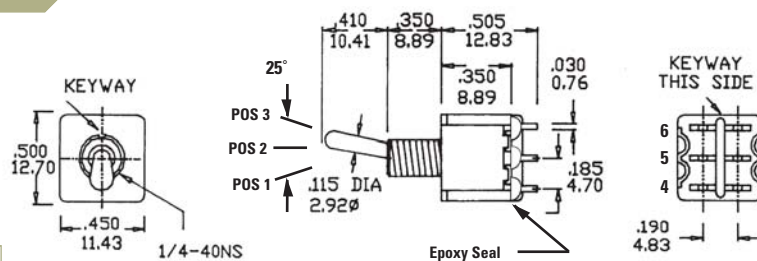

Model No.	POS 1	POS 2	POS 3
DP-1	ON	NONE	ON
DP-2	ON	NONE	(ON)
DP-3	ON	OFF	ON
DP-4	(ON)	OFF	(ON)
DP-5	ON	OFF	(ON)
DP-7	ON	ON	(ON)
DP-8	(ON)	ON	(ON)
Term. Comm.	2-3, 5-6	OPEN	2-1, 5-4

DP-6	ON	ON	ON
Term. Comm.	2-3, 5-6	2-3, 5-4	2-1, 5-4

( ) = Momentary

### 3PDT



SCHEMATIC

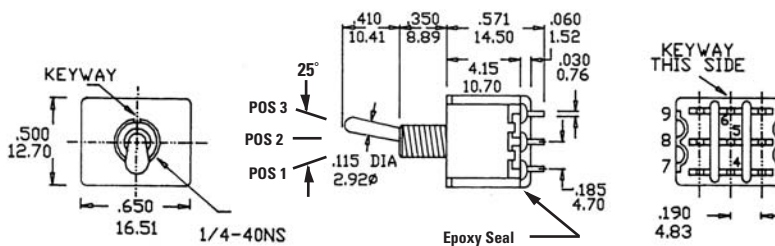

Model No.	POS 1	POS 2	POS 3
3P-1	ON	NONE	ON
3P-2	ON	NONE	(ON)
3P-3	ON	OFF	ON
3P-4	(ON)	OFF	(ON)
3P-5	ON	OFF	(ON)
Term. Comm.	2-3, 5-6 8-9	OPEN	2-1, 5-4 8-7

( ) = Momentary

### 4PDT

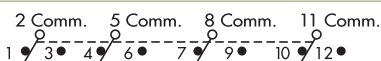

SCHEMATIC

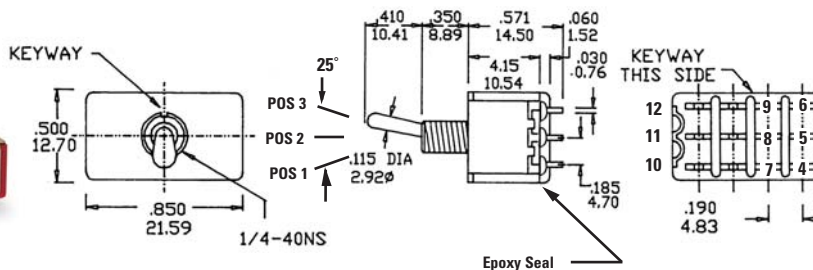

Model No.	POS 1	POS 2	POS 3
4P-1	ON	NONE	ON
4P-2	ON	NONE	(ON)
4P-3	ON	OFF	ON
4P-4	(ON)	OFF	(ON)
4P-5	ON	OFF	(ON)
4P-7	ON	ON	(ON)
4P-8	(ON)	ON	(ON)
Term. Comm.	2-3, 5-6 8-9 11-12	OPEN	2-1, 5-4 8-7 11-10

4P-6	ON	ON	ON
Term. Comm.	2-3, 5-6 8-9 11-12	2-3, 5-4 8-9 11-10	2-1, 5-4 8-7 11-10

( ) = Momentary

# SERIES 100 SWITCHES

## TOGGLE SWITCHES - MINIATURE

### 3 - WAY WIRING DIAGRAM SCHEMATICS

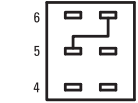

Bottom View  
or DP-6, DP-7, DP-8

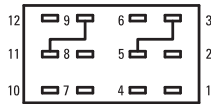

Bottom View  
for 4P-6, 4P-7, 4P-8

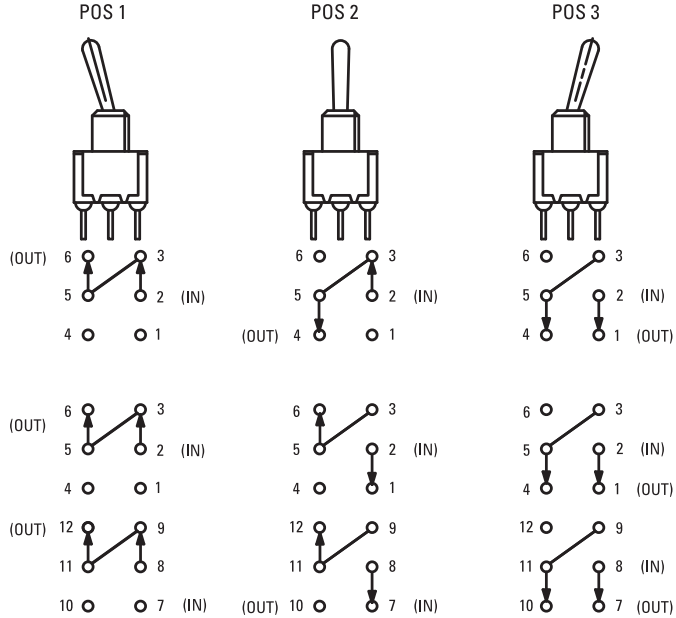

### ACTUATOR OPTIONS

**T1\*** STANDARD

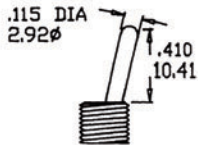

**T2\***

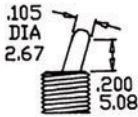

**T3\***



**T4\***

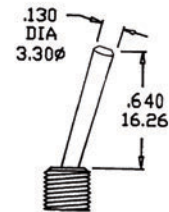

**T5\***

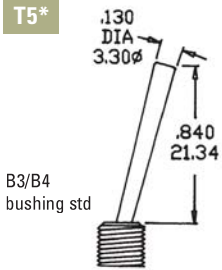

**T6** FLATTED WITH BUILT IN ANTIROTATION

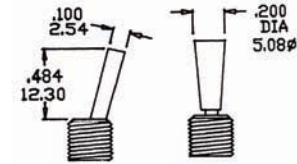

Use with B11, B12, B15, B16 only

**T7**

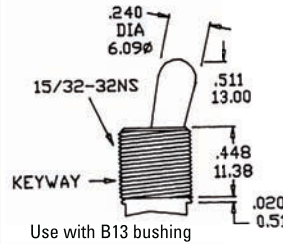

**T8**

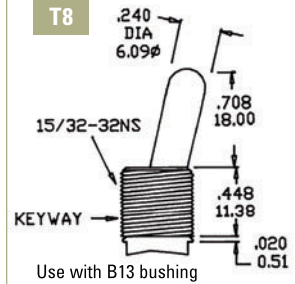

**T9\*** PLASTIC BLACK

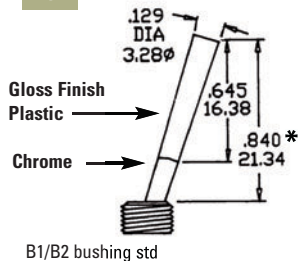

**K1**

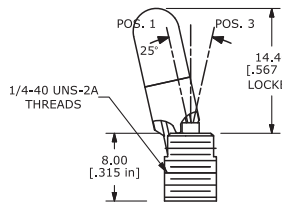

**K2**

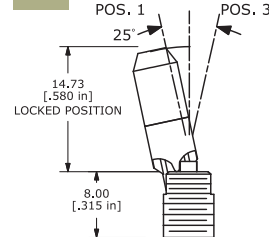

\*Add .070 (1.78) for B3, B4 bushings, subtract .020 (0.51) for B6 bushing.



### BUSHING OPTIONS

**B1 THD STD**

**B2 NON-THD**



**B3 THD STD**

**B4 NON-THD**

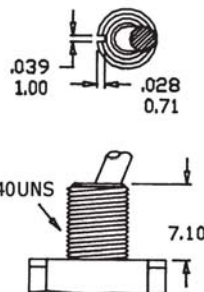

B4 is standard for M6, M7 and VS termination options.

**B5 HIGH TORQUE**

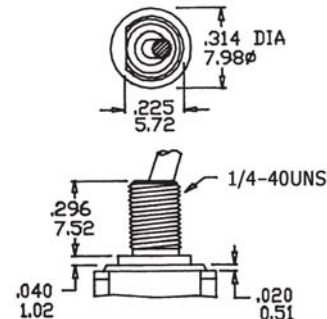

**B6 HIGH TORQUE**

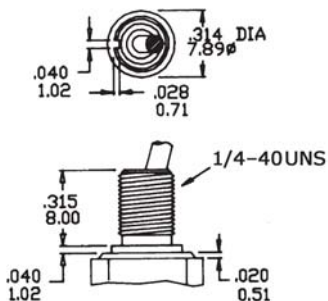

**B8 METRIC THD**

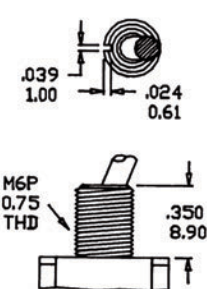

**B9 SPLASH PROOF**

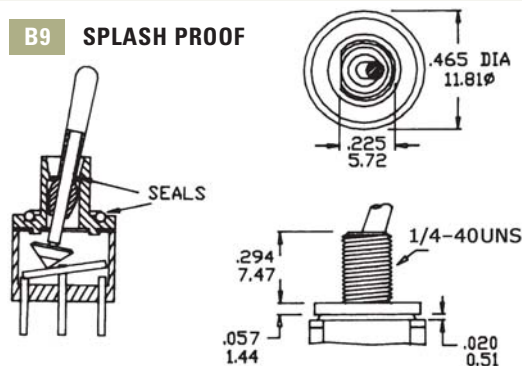

**B13**



Use with T7 and T8 actuators only

**B11 THD STD**

**B12 NON-THD**

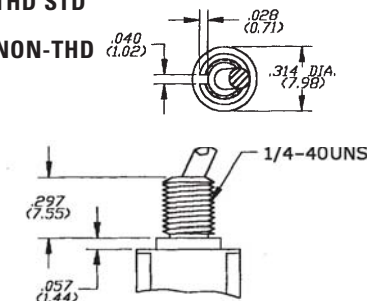

Use with T6 actuator only

**B15 THD STD**

**B16 NON-THD**

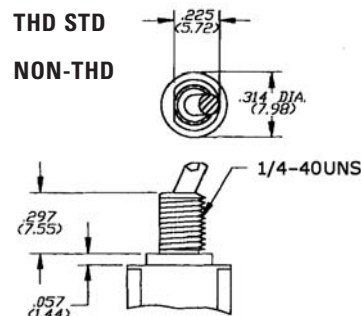

Use with T6 actuator only

**B25**



**B26**

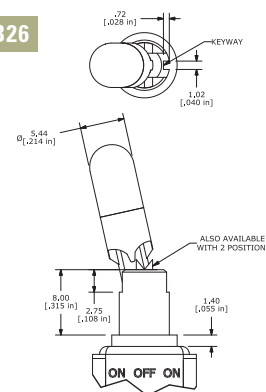

# SERIES 100 SWITCHES

## TOGGLE SWITCHES - MINIATURE

### BUSHING OPTIONS - PANEL MOUNTING



### TERMINATION OPTIONS

#### M2

#### SPDT

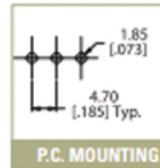

#### M1

#### SOLDER LUG

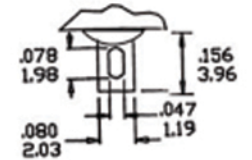

#### M3

#### QUICK CONNECT

Mating Quick Connector  
Amp P/N 61454-1

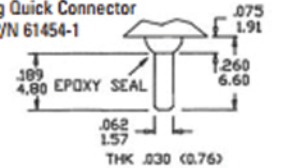

#### M2

#### DPDT

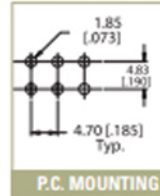
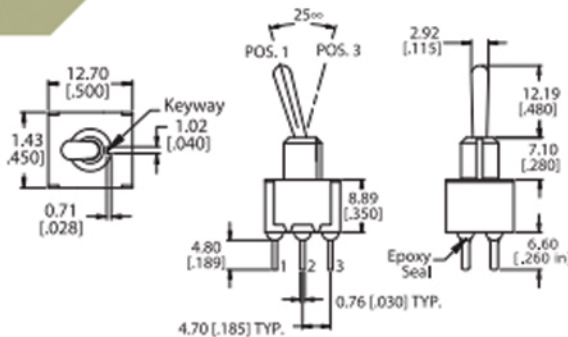

#### M5

#### WIRE WRAP

Option Code	Dim. 'A'
M51	.750 (18.7)
M52	.964 (24.48)
M53	.425 (10.80)
M54	1.062 (26.97)

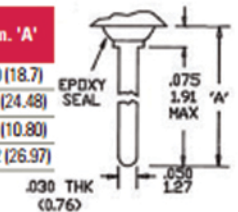

#### M6

#### SPDT

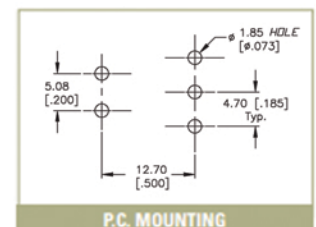
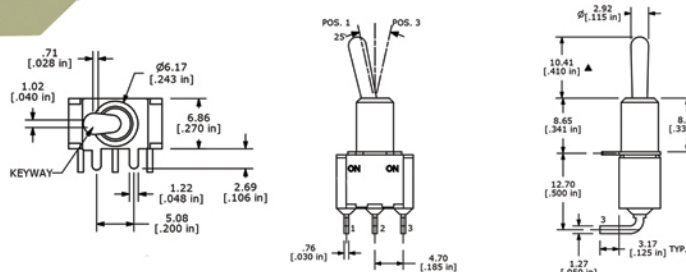



### M6

DPDT

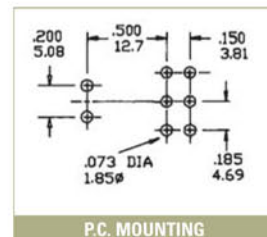
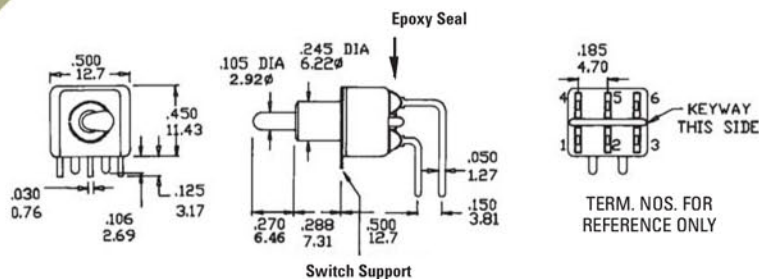

P.C. MOUNTING

### M7

SPDT

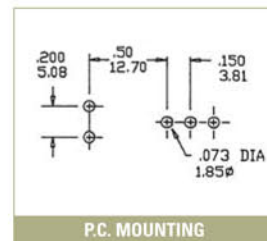
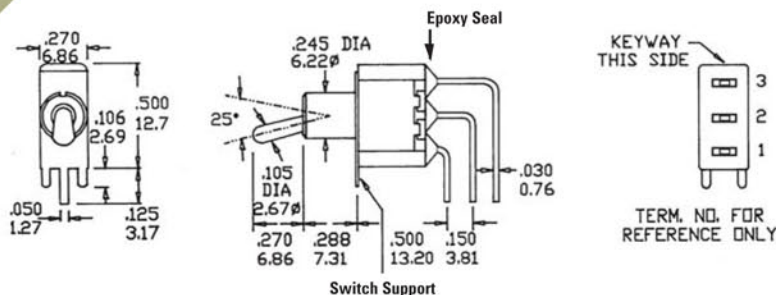

P.C. MOUNTING

### M7

DPDT

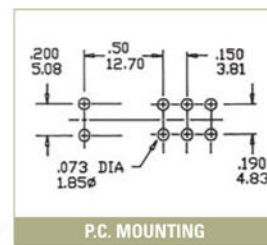
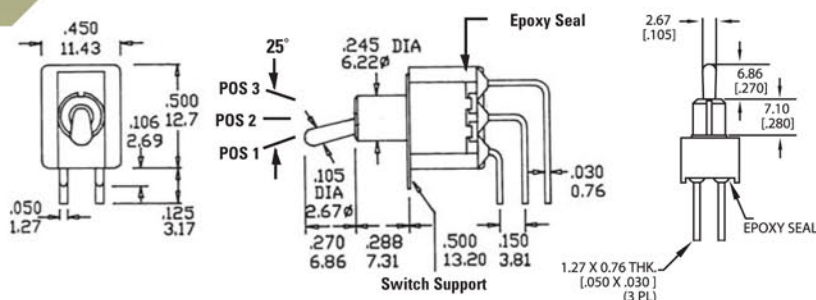

P.C. MOUNTING

### M7

3PDT

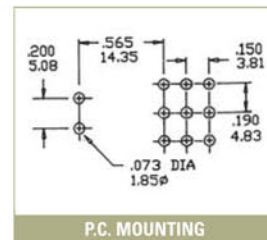
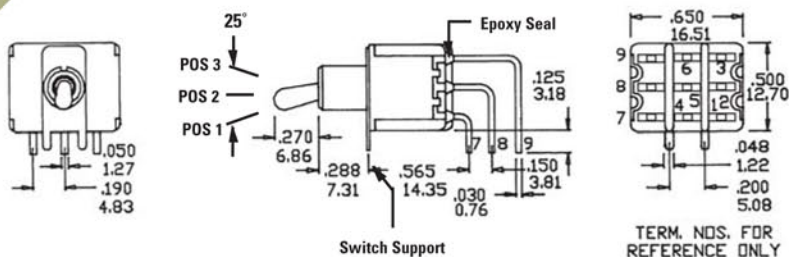

P.C. MOUNTING

### M7

4PDT

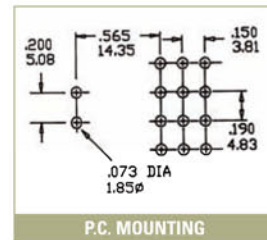
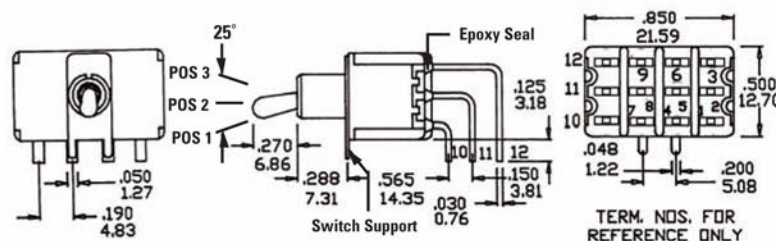

P.C. MOUNTING





### M61

DPDT

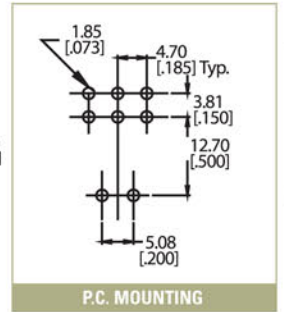
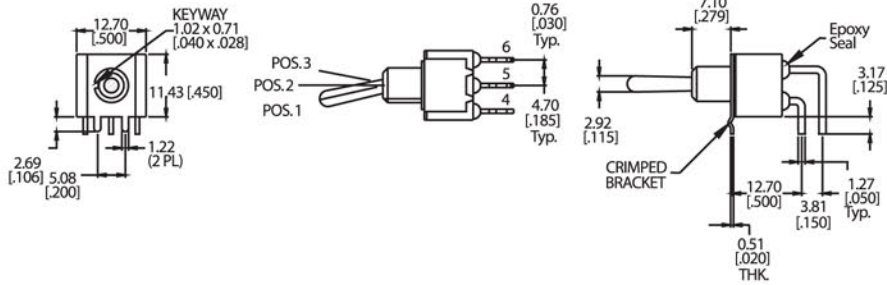

### M71

SPDT

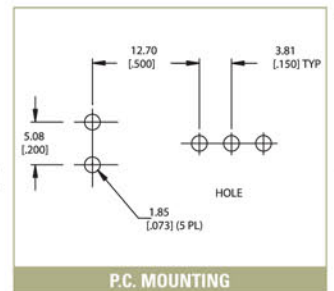
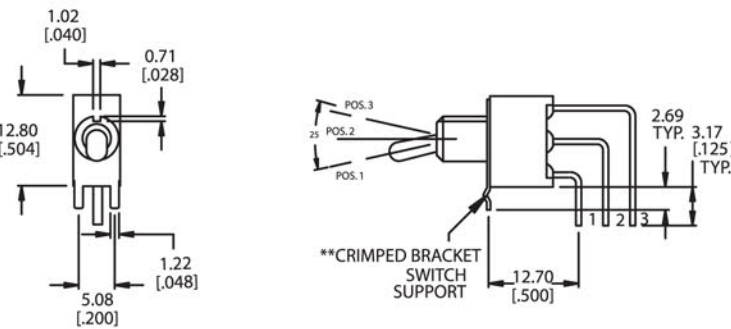

### M64

SPDT

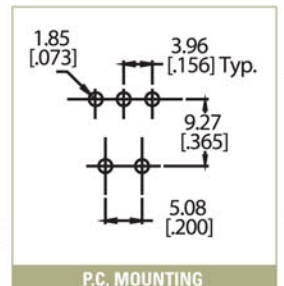
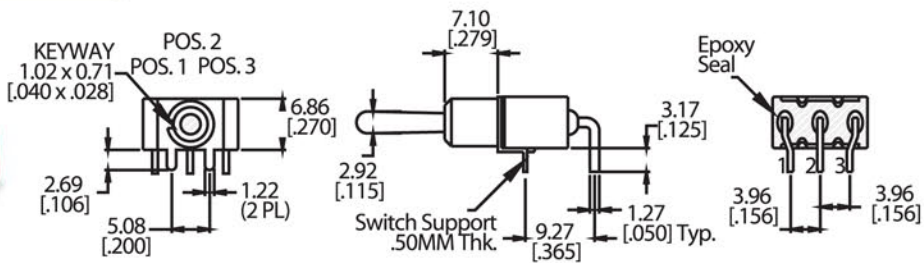

TACT SWITCHES

NAVIGATION SWITCHES

PUSHBUTTON SWITCHES

TOGGLE SWITCHES

ROCKER SWITCHES

SLIDE SWITCHES

SNAP-ACTION SWITCHES

DIP SWITCHES

KEYLOCK SWITCHES

ROTARY SWITCHES

DETECTOR SWITCHES

CAP OPTIONS



# SERIES 100 SWITCHES

## TOGGLE SWITCHES - MINIATURE

### VS21-VS31

SPDT

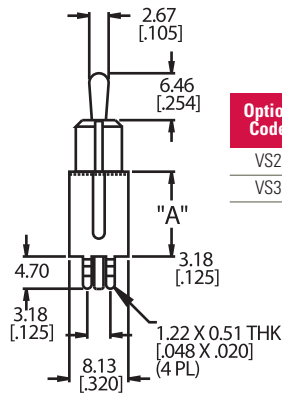

Option Code	Dim. 'A'
VS2	.460 (11.68)
VS3	.630 (16.00)



P.C. MOUNTING

### VS21-VS31

DPDT



Option Code	Dim. 'A'
VS2	.460 (11.68)
VS3	.630 (16.00)



P.C. MOUNTING

### OPTIONAL TOGGLE CAP



Use with T1  
T100-1 WHITE  
T100-2 BLACK



### CONTACT MATERIAL OPTIONS

**Q**

Fixed Terminal:	Silver plated over copper alloy
Moving Contact:	Silver plated over copper alloy
Rating:	5 Amps with resistive load @ 120VAC or 28VDC; 2 Amps with resistive load @ 250VAC

**R**

Fixed Terminal:	Copper alloy with gold plate over nickel plate
Moving Contact:	Copper alloy with gold plate over nickel plate
Rating:	0.4 Volt-Amps (VA) max. @ 20V max. (AC or DC)



**HARDWARE**

**HDW2 1/4 IN. NUTS**

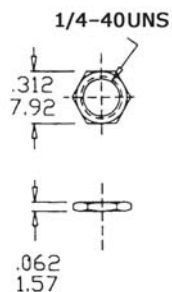

Supplied standard with B1, B3, B5, B6 and B9 options

**HDW3 BLIND DRESSNUT**

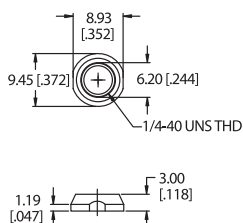

**HDW6 METRIC NUT**

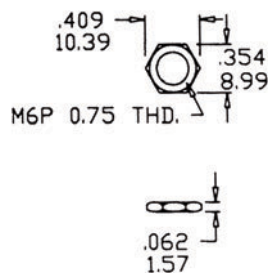

Supplied standard with B8 metric bushing

**HDW11 LOCK WASHER**

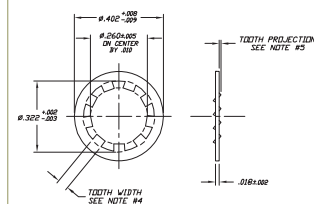

Supplied standard with B1/B3 bushing

**Optional Rubber Hood Sealing E1**

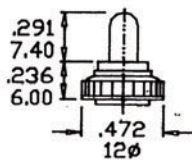

E1= Inch (Std.) for actuator T1, T2 and bushings B1, B3, B5, B6 Optional rubber boot sealing

**HDW4 15/32 IN. NUTS**

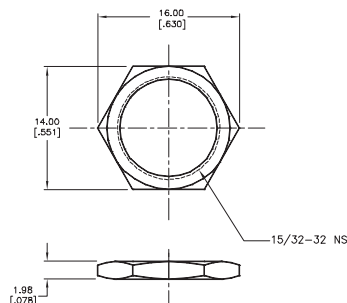

Supplied standard with B13 bushing

**HDW12 LOCK WASHER**

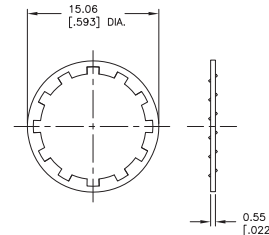

Supplied standard with B13 bushing

**HDW15 LOCKING RING**

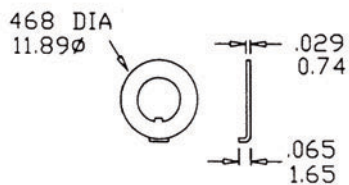

Supplied standard

**HDW16 LOCKING RING**

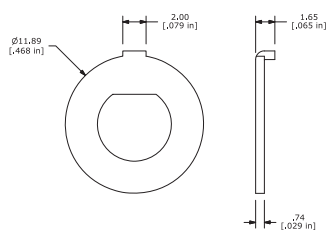

Supplied with B5 bushing

**HDW17 LOCKING RING**

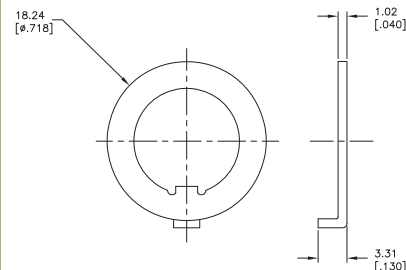

Supplied with B13 bushing

TACT SWITCHES

NAVIGATION SWITCHES

PUSHBUTTON SWITCHES

TOGGLE SWITCHES

ROCKER SWITCHES

SLIDE SWITCHES

SNAP-ACTION SWITCHES

DIP SWITCHES

KEYLOCK SWITCHES

ROTARY SWITCHES

DETECTOR SWITCHES

CAP OPTIONS

Компания «Океан Электроники» предлагает заключение долгосрочных отношений при поставках импортных электронных компонентов на взаимовыгодных условиях!

Наши преимущества:

- Поставка оригинальных импортных электронных компонентов напрямую с производств Америки, Европы и Азии, а так же с крупнейших складов мира;
- Широкая линейка поставок активных и пассивных импортных электронных компонентов (более 30 млн. наименований);
- Поставка сложных, дефицитных, либо снятых с производства позиций;
- Оперативные сроки поставки под заказ (от 5 рабочих дней);
- Экспресс доставка в любую точку России;
- Помощь Конструкторского Отдела и консультации квалифицированных инженеров;
- Техническая поддержка проекта, помощь в подборе аналогов, поставка прототипов;
- Поставка электронных компонентов под контролем ВП;
- Система менеджмента качества сертифицирована по Международному стандарту ISO 9001;
- При необходимости вся продукция военного и аэрокосмического назначения проходит испытания и сертификацию в лаборатории (по согласованию с заказчиком);
- Поставка специализированных компонентов военного и аэрокосмического уровня качества (Xilinx, Altera, Analog Devices, Intersil, Interpoint, Microsemi, Actel, Aeroflex, Peregrine, VPT, Syfer, Eurofarad, Texas Instruments, MS Kennedy, Miteq, Cobham, E2V, MA-COM, Hittite, Mini-Circuits, General Dynamics и др.);

Компания «Океан Электроники» является официальным дистрибьютором и эксклюзивным представителем в России одного из крупнейших производителей разъемов военного и аэрокосмического назначения «**JONHON**», а так же официальным дистрибьютором и эксклюзивным представителем в России производителя высокотехнологичных и надежных решений для передачи СВЧ сигналов «**FORSTAR**».



## JONHON

«**JONHON**» (основан в 1970 г.)

Разъемы специального, военного и аэрокосмического назначения:

(Применяются в военной, авиационной, аэрокосмической, морской, железнодорожной, горно- и нефтедобывающей отраслях промышленности)

«**FORSTAR**» (основан в 1998 г.)

ВЧ соединители, коаксиальные кабели,  
кабельные сборки и микроволновые компоненты:

(Применяются в телекоммуникациях гражданского и специального назначения, в средствах связи, РЛС, а так же военной, авиационной и аэрокосмической отраслях промышленности).



Телефон: 8 (812) 309-75-97 (многоканальный)

Факс: 8 (812) 320-03-32

Электронная почта: [ocean@oceanchips.ru](mailto:ocean@oceanchips.ru)

Web: <http://oceanchips.ru/>

Адрес: 198099, г. Санкт-Петербург, ул. Калинина, д. 2, корп. 4, лит. А