

SERIES 100 SWITCHES

TOGGLE SWITCHES - MINIATURE



SPECIFICATIONS

Contact Rating:	See contact material options
Life Expectancy:	40,000 make-and-break cycles
Contact Resistance:	10 mΩ max. typical initial @ 2-4 VDC 100 mA for both silver and gold plated contacts
Insulation Resistance:	1,000 MΩ min.
Dielectric Strength:	1,000 V RMS @ sea level
Operating Temperature:	-30° C to 85° C

MATERIALS

Case:	Diallyl Phthalate (DAP)
Toggle Handle:	Brass, chrome plated
Switch Support:	Brass or steel, tin plated
Bushing:	Brass, nickel plated
Housing:	Stainless steel
Contacts / Terminals:	Silver or gold plated copper alloy

FEATURES & BENEFITS

- ▶ Up to 4 poles available
- ▶ Variety of switching functions
- ▶ Miniature
- ▶ Multiple actuator & bushing options

APPLICATIONS/MARKETS

- ▶ Telecommunications
- ▶ Instrumentation
- ▶ Networking
- ▶ Medical equipment

HOW TO ORDER

SERIES	MODEL NO.	ACTUATOR	BUSHING	TERMINATION	CONTACT MATERIAL	SEAL	HARDWARE
100	□ □ □	□ □	□ □ □	□ □ □ □	□	E	□
	SP1 SP2* SP3 SP4* SP5* DP1 DP2* DP3 DP4* DP5* DP6 DP7* DP8* 3P1 3P2* 3P3 3P4* 3P5* 4P1 4P2* 4P3 4P4* 4P5* 4P6 4P7* 4P8*	T1† T2 T3 T4 T5 T6 T7 T8 T9 K1 K2 † Optional Toggle Cap (T1 Only): T100-1 = White T100-2 = Black	B1 B2 B3 B4 B5 B6 B8 B9 B11 B12 B13 B15 B16 B25** B26**	M1 M2 M3 M5 M6 M61 M7 M71 VS2 VS3 VS5* M64* VS21* VS31*	Q = Silver R = Gold	E = Epoxy Sealed at Base of Terminal	H = Hardware

Example Ordering Number
100-SP1-T4-B2-M1-R-E

Notes: * Not available with the K1 and K2 actuator options.

** Available only with the K1 and K2 actuator options.

Specifications subject to change without notice.



SPDT



SCHEMATIC

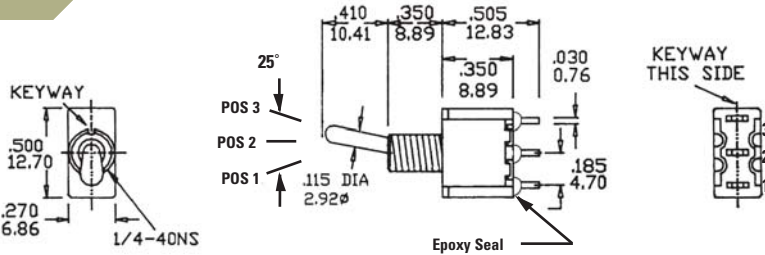

Model No.	POS 1	POS 2	POS 3
SP-1	ON	NONE	ON
SP-2	ON	NONE	(ON)
SP-3	ON	OFF	ON
SP-4	(ON)	OFF	(ON)
SP-5	ON	OFF	(ON)
Term. Comm.	2-3	OPEN	2-1

() = Momentary

DPDT



SCHEMATIC

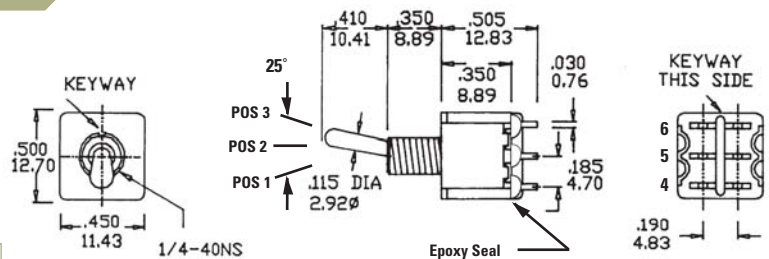

Model No.	POS 1	POS 2	POS 3
DP-1	ON	NONE	ON
DP-2	ON	NONE	(ON)
DP-3	ON	OFF	ON
DP-4	(ON)	OFF	(ON)
DP-5	ON	OFF	(ON)
DP-7	ON	ON	(ON)
DP-8	(ON)	ON	(ON)
Term. Comm.	2-3, 5-6	OPEN	2-1, 5-4

DP-6	ON	ON	ON
Term. Comm.	2-3, 5-6	2-3, 5-4	2-1, 5-4

() = Momentary

3PDT



SCHEMATIC

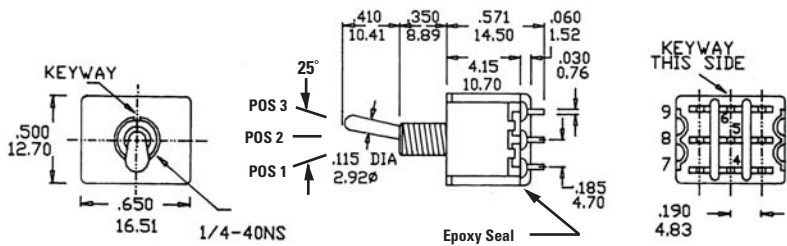

Model No.	POS 1	POS 2	POS 3
3P-1	ON	NONE	ON
3P-2	ON	NONE	(ON)
3P-3	ON	OFF	ON
3P-4	(ON)	OFF	(ON)
3P-5	ON	OFF	(ON)
Term. Comm.	2-3, 5-6 8-9	OPEN	2-1, 5-4 8-7

() = Momentary

4PDT



SCHEMATIC

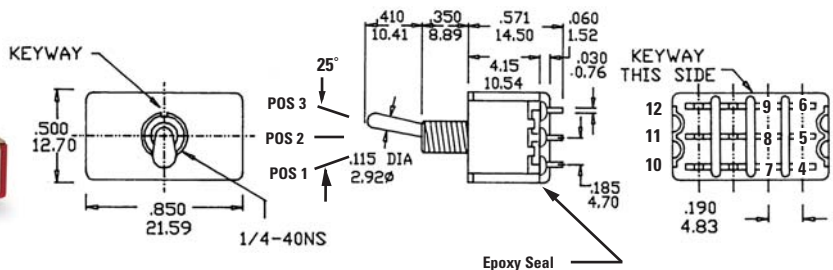

Model No.	POS 1	POS 2	POS 3
4P-1	ON	NONE	ON
4P-2	ON	NONE	(ON)
4P-3	ON	OFF	ON
4P-4	(ON)	OFF	(ON)
4P-5	ON	OFF	(ON)
4P-7	ON	ON	(ON)
4P-8	(ON)	ON	(ON)
Term. Comm.	2-3, 5-6 8-9 11-12	OPEN	2-1, 5-4 8-7 11-10

4P-6	ON	ON	ON
Term. Comm.	2-3, 5-6 8-9 11-12	2-3, 5-4 8-9 11-10	2-1, 5-4 8-7 11-10

() = Momentary

SERIES 100 SWITCHES

TOGGLE SWITCHES - MINIATURE

3 - WAY WIRING DIAGRAM SCHEMATICS



Bottom View
or DP-6, DP-7, DP-8



Bottom View
for 4P-6, 4P-7, 4P-8



ACTUATOR OPTIONS

T1* STANDARD



T2*



T3*



T4*



T5*



T6 FLATTED WITH BUILT IN ANTIROTATION

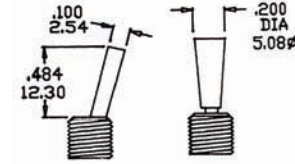

Use with B11, B12, B15, B16 only

T7

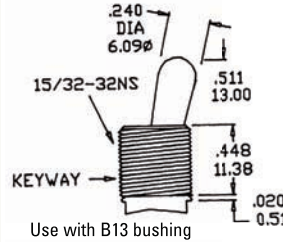

T8



T9* PLASTIC BLACK



K1



K2



*Add .070 (1.78) for B3, B4 bushings, subtract .020 (0.51) for B6 bushing.



BUSHING OPTIONS

B1 THD STD

B2 NON-THD



B3 THD STD

B4 NON-THD



B4 is standard for M6, M7 and VS termination options.

B5 HIGH TORQUE



B6 HIGH TORQUE



B8 METRIC THD



B9 SPLASH PROOF



B13



Use with T7 and T8 actuators only

B11 THD STD

B12 NON-THD



Use with T6 actuator only

B15 THD STD

B16 NON-THD



Use with T6 actuator only

B25



B26



SERIES 100 SWITCHES

TOGGLE SWITCHES - MINIATURE

BUSHING OPTIONS - PANEL MOUNTING



TERMINATION OPTIONS

M2

SPDT



M1

SOLDER LUG



M3

QUICK CONNECT



M2

DPDT



M5

WIRE WRAP

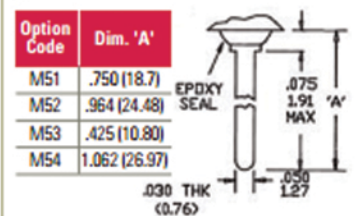

M6

SPDT





M6

DPDT



P.C. MOUNTING

M7

SPDT



P.C. MOUNTING

M7

DPDT

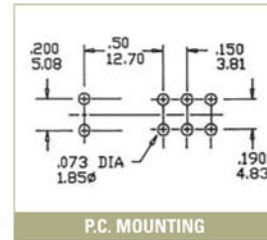

P.C. MOUNTING

M7

3PDT



P.C. MOUNTING

M7

4PDT



P.C. MOUNTING

SERIES 100 SWITCHES

TOGGLE SWITCHES - MINIATURE

TACT SWITCHES

NAVIGATION SWITCHES

PUSHBUTTON SWITCHES

TOGGLE SWITCHES

ROCKER SWITCHES

SLIDE SWITCHES

SNAP-ACTION SWITCHES

DIP SWITCHES

KEYLOCK SWITCHES

ROTARY SWITCHES

DETECTOR SWITCHES

CAP OPTIONS

VS2-VS3

SPDT



Option Code	Dim. 'A'
VS2	.460 (11.68)
VS3	.630 (16.00)



P.C. MOUNTING

VS2-VS3

DPDT



Option Code	Dim. 'A'
VS2	.460 (11.68)
VS3	.630 (16.00)



P.C. MOUNTING

VS5

DPDT

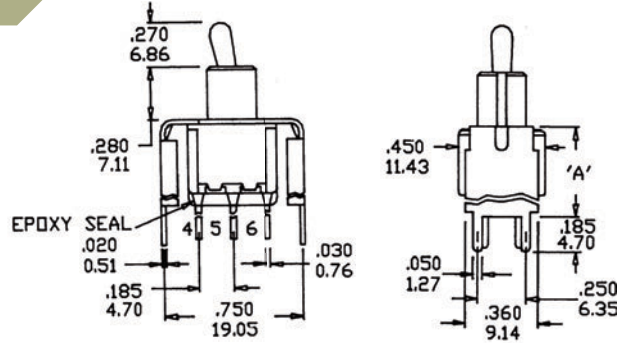

Option Code	Dim. 'A'
VS5	.630 (16.00)



P.C. MOUNTING

M61

SPDT

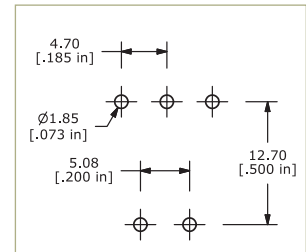
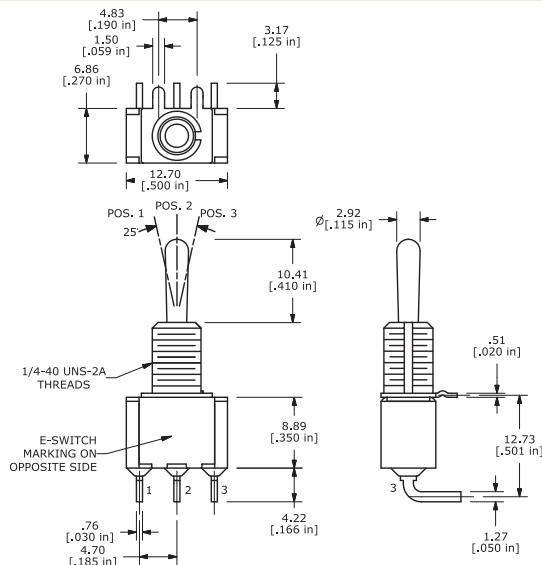

P.C. MOUNTING



M61

DPDT



M71

SPDT

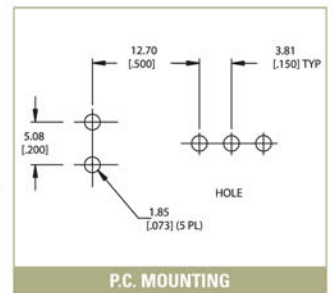

M64

SPDT

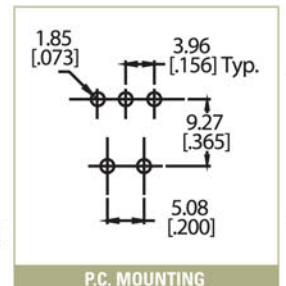

TACT SWITCHES
 NAVIGATION SWITCHES
 PUSHBUTTON SWITCHES
 TOGGLE SWITCHES
 ROCKER SWITCHES
 SLIDE SWITCHES
 SNAP-ACTION SWITCHES
 DIP SWITCHES
 KEYLOCK SWITCHES
 ROTARY SWITCHES
 DETECTOR SWITCHES
 CAP OPTIONS

SERIES 100 SWITCHES

TOGGLE SWITCHES - MINIATURE

VS21-VS31

SPDT



Option Code	Dim. 'A'
VS2	.460 (11.68)
VS3	.630 (16.00)



P.C. MOUNTING

VS21-VS31

DPDT



Option Code	Dim. 'A'
VS2	.460 (11.68)
VS3	.630 (16.00)



P.C. MOUNTING

OPTIONAL TOGGLE CAP



Use with T1
T100-1 WHITE
T100-2 BLACK



CONTACT MATERIAL OPTIONS

Q

Fixed Terminal:	Silver plated over copper alloy
Moving Contact:	Silver plated over copper alloy
Rating:	5 Amps with resistive load @ 120VAC or 28VDC; 2 Amps with resistive load @ 250VAC

R

Fixed Terminal:	Copper alloy with gold plate over nickel plate
Moving Contact:	Copper alloy with gold plate over nickel plate
Rating:	0.4 Volt-Amps (VA) max. @ 20V max. (AC or DC)



HARDWARE

HDW2 1/4 IN. NUTS



Supplied standard with B1, B3, B5, B6 and B9 options

HDW3 BLIND DRESSNUT



HDW6 METRIC NUT



Supplied standard with B8 metric bushing

HDW11 LOCK WASHER



Supplied standard with B1/B3 bushing

Optional Rubber Hood Sealing E1



E1= Inch (Std.) for actuator T1, T2 and bushings B1, B3, B5, B6 Optional rubber boot sealing

HDW4 15/32 IN. NUTS



Supplied standard with B13 bushing

HDW12 LOCK WASHER



Supplied standard with B13 bushing

HDW15 LOCKING RING



Supplied standard

HDW16 LOCKING RING



Supplied with B5 bushing

HDW17 LOCKING RING

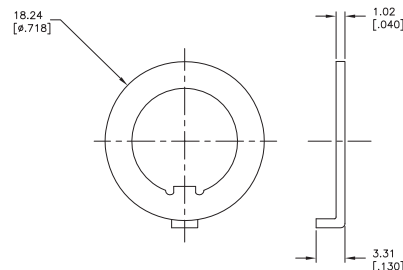

Supplied with B13 bushing

TACT SWITCHES

NAVIGATION SWITCHES

PUSHBUTTON SWITCHES

TOGGLE SWITCHES

ROCKER SWITCHES

SLIDE SWITCHES

SNAP-ACTION SWITCHES

DIP SWITCHES

KEYLOCK SWITCHES

ROTARY SWITCHES

DETECTOR SWITCHES

CAP OPTIONS

Компания «Океан Электроники» предлагает заключение долгосрочных отношений при поставках импортных электронных компонентов на взаимовыгодных условиях!

Наши преимущества:

- Поставка оригинальных импортных электронных компонентов напрямую с производств Америки, Европы и Азии, а так же с крупнейших складов мира;
- Широкая линейка поставок активных и пассивных импортных электронных компонентов (более 30 млн. наименований);
- Поставка сложных, дефицитных, либо снятых с производства позиций;
- Оперативные сроки поставки под заказ (от 5 рабочих дней);
- Экспресс доставка в любую точку России;
- Помощь Конструкторского Отдела и консультации квалифицированных инженеров;
- Техническая поддержка проекта, помощь в подборе аналогов, поставка прототипов;
- Поставка электронных компонентов под контролем ВП;
- Система менеджмента качества сертифицирована по Международному стандарту ISO 9001;
- При необходимости вся продукция военного и аэрокосмического назначения проходит испытания и сертификацию в лаборатории (по согласованию с заказчиком);
- Поставка специализированных компонентов военного и аэрокосмического уровня качества (Xilinx, Altera, Analog Devices, Intersil, Interpoint, Microsemi, Actel, Aeroflex, Peregrine, VPT, Syfer, Eurofarad, Texas Instruments, MS Kennedy, Miteq, Cobham, E2V, MA-COM, Hittite, Mini-Circuits, General Dynamics и др.);

Компания «Океан Электроники» является официальным дистрибьютором и эксклюзивным представителем в России одного из крупнейших производителей разъемов военного и аэрокосмического назначения «JONHON», а так же официальным дистрибьютором и эксклюзивным представителем в России производителя высокотехнологичных и надежных решений для передачи СВЧ сигналов «FORSTAR».



JONHON

«JONHON» (основан в 1970 г.)

Разъемы специального, военного и аэрокосмического назначения:

(Применяются в военной, авиационной, аэрокосмической, морской, железнодорожной, горно- и нефтедобывающей отраслях промышленности)

«FORSTAR» (основан в 1998 г.)

ВЧ соединители, коаксиальные кабели, кабельные сборки и микроволновые компоненты:

(Применяются в телекоммуникациях гражданского и специального назначения, в средствах связи, РЛС, а так же военной, авиационной и аэрокосмической отраслях промышленности).



Телефон: 8 (812) 309-75-97 (многоканальный)

Факс: 8 (812) 320-03-32

Электронная почта: ocean@oceanchips.ru

Web: <http://oceanchips.ru/>

Адрес: 198099, г. Санкт-Петербург, ул. Калинина, д. 2, корп. 4, лит. А