



High Performance Backshells and Caps

SUNBANK products define the standard for highly reliable, environment resisting, electrically passive components. We offer a full range of backshells and caps in different materials and platings.

Highest reliability ■ Qualified according to:
· AS85049
· MIL-DTL-38999
· MS27501/MS27502



Designed for a wide range of qualified products ■ Available for most of the standard connectors known on the market.

Many plating options ■ High corrosion resistance and electrical continuity properties.

M85049 Backshells / D38999 & MS27 Protective Caps

Overview

Backshell style	Connector type	AS85049 Series
Cable clamp strain relief 	MIL-DTL-38999 Series III & IV EN3645	AS85049/38 - see p.03
	MIL-DTL-27599 MIL-DTL-38999 Series I & II	AS85049/49-2 - see p.05
	MIL-DTL-5015 crimp MIL-DTL-26482 Series 2 AS81703 Series 3 MIL-DTL-83723 Series 1 & 3	AS85049/43 - see p.04 AS85049/51 - see p.06 AS85049/52 - see p.07
One arm strain relief 	MIL-DTL-5015 crimp MIL-DTL-26482 Series 2 AS81703 Series 3 MIL-DTL-83723 Series 1 & 3	AS85049/53 - see p.08 AS85049/54 - see p.08 AS85049/55 - see p.08
Shrink boot adapter 	MIL-DTL-5015 crimp MIL-DTL-26482 Series 2 AS81703 Series 3 MIL-DTL-83723 Series 1 & 3	AS85049/60-1 - see p.09
	MIL-DTL-27599 MIL-DTL-38999 Series I & II	AS85049/62 - see p.10
	MIL-DTL-38999 Series III & IV EN3645	AS85049/69 - see p.11
Banding backshell with self-locking 	MIL-DTL-5015 crimp MIL-DTL-26482 Series 2 AS81703 Series 3 MIL-DTL-83723 Series 1 & 3	AS85049/82 - see p.12 AS85049/83 - see p.12 AS85049/84 - see p.12
	MIL-DTL-27599 MIL-DTL-38999 Series I & II	AS85049/85 - see p.13 AS85049/86 - see p.13 AS85049/87 - see p.13
	MIL-DTL-38999 Series III & IV EN3645	AS85049/88 - see p.14 AS85049/89 - see p.14 AS85049/90 - see p.14
Shield support ring 	All	AS85049/93 - see p.15

Cap style	Connector type	Series
Screw mating 	MIL-DTL-38999 Series III	D38999 - see p.16
Bayonet mating 	MIL-DTL-38999 Series I	MS27 - see p.17

M85049 Backshells

AS85049/38 Series - Cable clamp strain relief

For connectors:

- MIL-DTL-38999 Series III & IV
- EN3645

Ordering information

Basic Series	M85049/38	S	11	N
Self-locking option				
S: Self-locking, detented - utilizes an audible detented anti-decoupling device.				
N: Self-locking, non detented - utilizes an internal captivated anti-decoupling device (Self-Seating) with no audible clicking mechanism.				
- : Non self locking				
Shell size				
9, 11, 13, 15, 16, 17, 19, 21, 23, 25				
Material and plating				
A: Aluminum, black anodize				
N: Aluminum, electroless nickel				
S: Stainless steel, passivated				
W: Aluminum, olive drab cadmium over electroless nickel, 500 hours salt spray				

Dimensions



Shell size	A Thread Class 2B	B Max Self-locking only		C Max Self-locking only		D Max		Cable entry Min		Cable entry Max	
		inch	mm	inch	mm	inch	mm	inch	mm	inch	mm
9	M12X1-6H	0.858	21.79	0.91	23.11	0.85	21.60	0.098	2.49	0.234	5.94
11	M15X1-6H	0.984	24.99	0.91	23.11	0.90	22.90	0.153	3.89	0.234	5.94
13	M18X1-6H	1.157	29.39	1.01	25.65	1.10	27.90	0.19	4.83	0.328	8.33
15	M22X1-6H	1.279	32.49	1.06	26.92	1.15	29.20	0.26	6.60	0.457	11.61
17	M25X1-6H	1.406	35.71	1.16	29.46	1.30	33.00	0.283	7.19	0.614	15.60
19	M28X1-6H	1.516	38.51	1.41	(35.81)	1.50	38.10	0.325	8.26	0.634	16.10
21	M31X1-6H	1.642	41.71	1.51	38.35	1.60	40.60	0.343	8.71	0.698	17.73
23	M34X1-6H	1.768	44.91	1.66	42.16	1.70	43.20	0.381	9.68	0.823	20.90
25	M37X1-6H	1.889	47.98	1.76	44.70	1.80	45.70	0.418	10.62	0.853	21.67

Note: All dimensions are in inches and millimeters (inch/mm). For complete dimensions, see the applicable Military Specification. Cable entry is defined as the envelope area of the cable or wire bundle. It is not intended for inspection criteria.

M85049 Backshells

AS85049/43 Series - 45° cable clamp strain relief

For connectors:

MIL-DTL-5015 crimp

MIL-DTL-26482 Series 2

AS81703 Series 3

MIL-DTL-83723 Series 1 & 3

Ordering information

Basic Series	M85049/43	-	10	N
Self-locking option				
- : Non self locking				
Shell size				
3, 8, 10, 12, 14, 16, 18, 20, 22, 24, 28, 32, 36, 40, 44, 48, 61				
Material and plating				
N: Aluminum, electroless nickel				
W: Aluminum, olive drab cadmium over electroless nickel, 1000 hours salt spray				

Dimensions

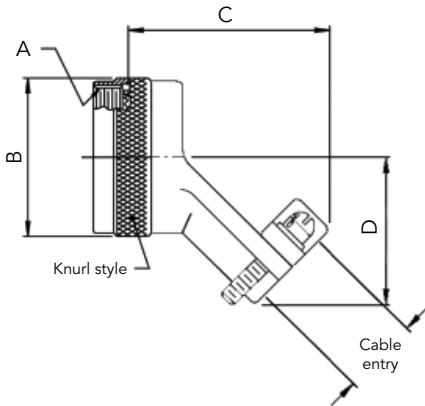

Shell size	A Thread Class 2B	B Max		C Max closed		D Max		Cable entry Min		Cable entry Max	
		inch	mm	inch	mm	inch	mm	inch	mm	inch	mm
3	0.562 - 24 UNEF	0.669	16.99	1.160	29.46	0.772	19.61	0.125	3.20	0.204	5.20
8	0.500 - 20 UNF	0.885	22.50	1.650	41.91	0.772	19.61	0.125	3.20	0.204	5.20
10	0.625 - 24 UNEF	1.010	25.70	1.694	43.03	0.803	20.40	0.187	4.70	0.286	7.30
12	0.750 - 20 UNEF	1.135	28.80	1.768	44.91	0.866	21.00	0.291	7.40	0.416	10.60
14	0.875 - 20 UNEF	1.260	32.00	1.840	46.74	0.928	23.57	0.351	8.90	0.476	12.10
16	1.000 - 20 UNEF	1.385	35.20	1.916	48.67	0.991	25.17	0.501	12.70	0.625	15.90
18	1.062 - 18 UNEF	1.570	39.88	2.034	51.66	1.110	28.19	0.518	13.20	0.706	17.90
20	1.188 - 18 UNEF	1.635	41.50	2.078	52.78	1.172	29.77	0.581	14.80	0.831	21.10
22	1.313 - 18 UNEF	1.760	44.70	2.122	53.90	1.235	31.37	0.644	16.40	0.956	24.30
24	1.438 - 18 UNEF	1.885	47.90	2.166	55.02	1.297	32.94	0.706	17.90	1.081	27.50
28	1.750 - 18 UNS	2.135	54.20	2.461	62.51	1.543	39.19	0.750	19.10	1.187	30.10
32	2.000 - 18 UNS	2.315	58.80	2.549	64.75	1.668	42.37	0.875	22.20	1.250	31.80
36	2.250 - 16 UN	2.635	66.90	2.595	65.91	1.793	45.54	0.938	23.80	1.375	34.90
40	2.500 - 16 UN	2.885	73.30	2.599	66.01	1.918	48.72	0.938	23.80	1.500	38.10
44	2.750 - 16 UN	3.135	79.60	2.860	72.64	2.132	54.15	1.188	30.20	1.750	44.50
48	3.000 - 16 UN	3.385	86.00	2.918	74.12	2.257	57.33	1.312	33.30	1.875	47.60
61	1.500 - 18 UNEF	1.653	41.99	1.676	42.57	1.204	30.58	0.706	17.90	1.081	27.50

Note: All dimensions are in inches and millimeters (inch/mm). For complete dimensions, see the applicable Military Specification. Cable entry is defined as the envelope area of the cable or wire bundle. It is not intended for inspection criteria.

M85049 Backshells

AS85049/49-2 Series - Cable clamp strain relief

For connectors:

MIL-DTL-27599

MIL-DTL-38999 Series I & II

Ordering information

Basic Series	M85049/49-2	S	10	N
Self-locking option				
S: Self-locking, detented - utilizes an audible detented anti-decoupling device.				
N: Self-locking, non detented - utilizes an internal captivated anti-decoupling device (Self-Seating) with no audible clicking mechanism.				
- : Non self locking				
Shell size				
8, 10, 12, 14, 16, 18, 20, 22, 24				
Material and plating				
A: Aluminum, black anodize				
N: Aluminum, electroless nickel				
S: Stainless steel, passivated				
W: Aluminum, olive drab cadmium over electroless nickel, 1000 hours salt spray				

Dimensions

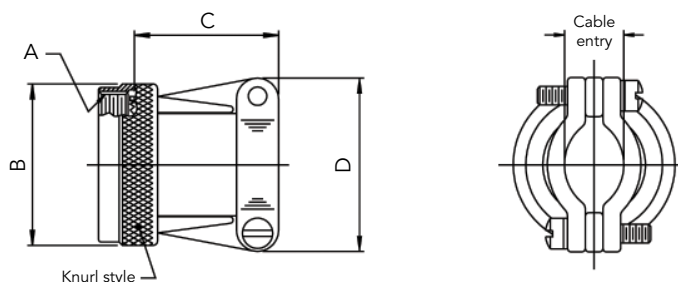

Shell size	A Thread Class 2B	B Max Self-locking only		C Max Self-locking only		D Max		Cable entry Min		Cable entry Max	
		inch	mm	inch	mm	inch	mm	inch	mm	inch	mm
8	0.438-28 UNEF	0.858	21.80	0.91	23.10	0.85	21.60	0.098	2.50	0.234	5.90
10	0.562-24 UNEF	0.984	25.00	0.91	23.10	0.90	22.90	0.153	3.90	0.234	5.90
12	0.688-24 UNEF	1.157	29.40	1.01	25.70	1.10	27.90	0.19	4.80	0.328	8.30
14	0.812-20 UNEF	1.279	32.50	1.06	26.90	1.15	29.20	0.26	6.60	0.457	11.60
16	0.938-20 UNEF	1.406	35.70	1.16	29.50	1.30	33.00	0.283	7.20	0.614	15.60
18	1.062-18 UNEF	1.516	38.50	1.41	35.80	1.50	38.10	0.325	8.30	0.634	16.10
20	1.188-18 UNEF	1.642	41.70	1.51	38.40	1.60	40.60	0.343	8.70	0.698	17.70
22	1.312-18 UNEF	1.768	44.90	1.66	42.20	1.70	43.20	0.381	9.70	0.823	20.90
24	1.438-18 UNEF	1.889	48.00	1.76	44.70	1.80	45.70	0.418	10.60	0.853	21.70

Note: All dimensions are in inches and millimeters (inch/mm). For complete dimensions, see the applicable Military Specification. Cable entry is defined as the envelope area of the cable or wire bundle. It is not intended for inspection criteria.

M85049 Backshells

AS85049/51 Series - 90° cable clamp strain relief

For connectors:

MIL-DTL-5015 crimp

MIL-DTL-26482 Series 2

AS81703 Series 3

MIL-DTL-83723 Series 1 & 3

Ordering information

Basic Series	AS85049/51	S	10	N
Self-locking option				
S: Self-locking, detented - utilizes an audible detented anti-decoupling device.				
N: Self-locking, non detented - utilizes an internal captivated anti-decoupling device (Self-Seating) with no audible clicking mechanism.				
-1: Non self locking				
Shell size				
3, 8, 10, 12, 14, 16, 18, 20, 22, 24, 28, 32, 36, 40, 44, 48, 61				
Material and plating				
A: Aluminum, black anodize				
N: Aluminum, electroless nickel				
W: Aluminum, olive drab cadmium over electroless nickel, 1000 hours salt spray				

Dimensions

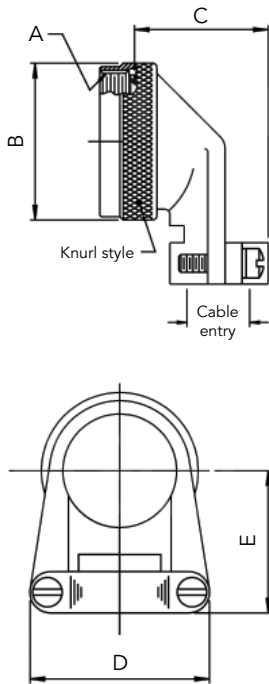

Shell size	A Thread Class 2B	B Max Self-locking only		C Max Self-locking only		D Max		E ± 0.062 / 1.6		Cable entry Min		Cable entry Max	
		inch	mm	inch	mm	inch	mm	inch	mm	inch	mm	inch	mm
3	0.562 - 24 UNEF	Not available in self-locking		0.782	19.90	0.777	19.70	0.125	3.20	0.204	5.20		
8	0.500 - 20 UNF	0.885	22.50	1.257	31.90	0.782	19.90	0.746	18.90	0.125	3.20	0.204	5.20
10	0.625 - 24 UNEF	1.010	25.70	1.339	34.00	0.862	21.90	0.805	20.40	0.187	4.70	0.286	7.30
12	0.750 - 20 UNEF	1.135	28.80	1.532	38.90	0.968	24.60	0.867	22.00	0.291	7.40	0.416	10.60
14	0.875 - 20 UNEF	1.26	32.00	1.592	40.40	1.003	25.50	0.930	23.60	0.351	8.90	0.476	12.10
16	1.000 - 20 UNEF	1.385	35.20	1.741	44.20	1.061	26.90	0.994	25.20	0.501	12.70	0.626	15.90
18	1.062 - 18 UNEF	1.510	38.40	1.853	47.10	1.394	35.40	1.171	29.70	0.518	13.20	0.706	17.90
20	1.188 - 18 UNEF	1.635	41.50	1.978	50.20	1.466	37.20	1.234	31.20	0.581	14.80	0.831	21.10
22	1.313 - 18 UNEF	1.760	44.70	2.108	53.50	1.572	39.90	1.296	32.90	0.644	16.40	0.956	24.30
24	1.438 - 18 UNEF	1.885	47.90	2.228	56.60	1.698	43.10	1.358	34.50	0.706	17.90	1.081	27.50
28	1.750 - 18 UNS	2.135	54.20	2.528	64.20	1.790	45.50	1.572	39.90	0.750	19.10	1.187	30.10
32	2.000 - 18 UNS	2.395	60.80	2.591	65.80	2.035	51.70	1.797	45.60	0.875	22.20	1.250	31.80
36	2.250 - 16 UN	2.635	66.90	2.716	69.00	2.386	60.60	1.922	48.80	0.938	23.80	1.375	34.90
40	2.500 - 16 UN	2.885	73.30	2.841	72.20	2.566	65.20	2.047	52.00	0.938	23.80	1.500	38.10
44	2.750 - 16 UN	3.135	79.60	3.091	78.50	2.86	72.60	2.296	58.30	1.188	30.20	1.750	44.50
48	3.000 - 16 UN	3.385	86.00	3.216	81.70	3.344	84.90	2.421	61.50	1.312	33.30	1.875	47.60
61	1.500 - 18 UNEF	Not available in self-locking		1.775	45.10	1.388	35.30	0.706	17.90	1.081	27.50		

Note: All dimensions are in inches and millimeters (inch/mm). For complete dimensions, see the applicable Military Specification. Cable entry is defined as the envelope area of the cable or wire bundle. It is not intended for inspection criteria.

M85049 Backshells

AS85049/52 Series - Straight cable clamp strain relief

For connectors:

MIL-DTL-5015 crimp

MIL-DTL-26482 Series 2

AS81703 Series 3

MIL-DTL-83723 Series 1 & 3

Ordering information

Basic Series	AS85049/52	S	10	N
Self-locking option				
S: Self-locking, detented - utilizes an audible detented anti-decoupling device.				
N: Self-locking, non detented - utilizes an internal captivated anti-decoupling device (Self-Seating) with no audible clicking mechanism.				
-1: Non self locking				
Shell size				
3, 8, 10, 12, 14, 16, 18, 20, 22, 24, 28, 32, 36, 40, 44, 48, 61				
Material and plating				
A: Aluminum, black anodize				
N: Aluminum, electroless nickel				
W: Aluminum, olive drab cadmium over electroless nickel, 1000 hours salt spray				

Dimensions



Shell size	A Thread Class 2B	B Max Self-locking only		C Max Self-locking only		D Max		Cable entry Min		Cable entry Max	
		inch	mm	inch	mm	inch	mm	inch	mm	inch	mm
3	0.562 - 24 UNEF	Not available in self-locking				0.782	19.90	0.125	3.20	0.204	5.20
8	0.500 - 20 UNF	0.885	22.50	0.73	18.50	0.782	19.90	0.125	3.20	0.204	5.20
10	0.625 - 24 UNEF	1.010	25.70	0.85	21.60	0.862	21.90	0.187	4.70	0.286	7.30
12	0.750 - 20 UNEF	1.135	28.80	0.98	24.90	0.968	24.60	0.291	7.40	0.416	10.60
14	0.875 - 20 UNEF	1.26	32.00	0.98	24.90	1.003	25.50	0.351	8.90	0.476	12.10
16	1.000 - 20 UNEF	1.385	35.20	1.10	27.90	1.061	26.90	0.501	12.70	0.626	15.90
18	1.062 - 18 UNEF	1.510	38.40	1.35	34.30	1.394	35.40	0.518	13.20	0.706	17.90
20	1.188 - 18 UNEF	1.635	41.50	1.48	37.60	1.466	37.20	0.581	14.80	0.831	21.10
22	1.313 - 18 UNEF	1.760	44.70	1.60	40.60	1.572	39.90	0.644	16.40	0.956	24.30
24	1.438 - 18 UNEF	1.885	47.90	1.73	43.90	1.698	43.10	0.706	17.90	1.081	27.50
28	1.750 - 18 UNS	2.135	54.20	1.88	47.80	1.790	45.50	0.750	19.10	1.187	30.10
32	2.000 - 18 UNS	2.395	60.80	2.13	54.10	2.035	51.70	0.875	22.20	1.250	31.80
36	2.250 - 16 UN	2.635	66.90	2.44	62.00	2.386	60.60	0.938	23.80	1.375	34.90
40	2.500 - 16 UN	2.885	73.30	2.63	66.80	2.566	65.20	0.938	23.80	1.500	38.10
44	2.750 - 16 UN	3.135	79.60	3.00	76.20	2.86	72.60	1.188	30.20	1.750	44.50
48	3.000 - 16 UN	3.385	86.00	3.40	86.40	3.344	84.90	1.312	33.30	1.875	47.60
61	1.500 - 18 UNEF	Not available in self-locking				1.775	45.10	0.706	17.90	1.081	27.50

Note: All dimensions are in inches and millimeters (inch/mm). For complete dimensions, see the applicable Military Specification. Cable entry is defined as the envelope area of the cable or wire bundle. It is not intended for inspection criteria.

M85049 Backshells

AS85049/53, 54, 55 Series - One arm strain relief

For connectors:

MIL-DTL-5015 crimp

MIL-DTL-26482 Series 2

AS81703 Series 3

MIL-DTL-83723 Series 1 & 3

Ordering information

Basic Series	AS85049/	53	-	10	N
Angle					
53: Straight					
54: 45°					
55: 90°					
Self-locking option					
- : Non self locking					
Shell size					
3, 8, 10, 12, 14, 16, 18, 20, 22, 24, 28					
Material and plating					
A: Aluminum, black anodize					
N: Aluminum, electroless nickel					
W: Aluminum, olive drab cadmium over electroless nickel, 1000 hours salt spray					

Dimensions



For new design use:
M85049/43 (45°),
M85049/51 (90°) and
M85049/52 (straight)

Shell size	A Thread Class 2B	B Max		C Max		D Max		E Max		F Max		Cable entry	
		inch	mm	inch	mm	inch	mm	inch	mm	inch	mm	inch	mm
3	0.562 - 24 UNEF	0.780	19.80	0.954	24.00	1.232	31.30	0.730	18.50	1.290	32.80	0.260	6.60
8	0.500 - 20 UNF	0.660	16.80									0.260	6.60
10	0.625 - 24 UNEF	0.780	19.80									0.365	9.30
12	0.750 - 20 UNEF	0.940	23.90	1.204	30.60	1.482	37.60	0.750	19.10	1.620	41.10	0.501	12.70
14	0.875 - 20 UNEF	1.050	26.70							1.660	42.20	0.575	14.60
16	1.000 - 20 UNEF	1.240	31.50							1.720	43.70	0.700	17.80
18	1.062 - 18 UNEF	1.380	35.10	1.310	33.30	1.469	37.30	0.750	19.10	1.790	45.50	0.904	23.00
20	1.188 - 18 UNEF	1.500	38.10							1.850	47.00	1.029	26.10
22	1.313 - 18 UNEF	1.630	41.40							1.430	36.30	1.910	48.50
24	1.438 - 18 UNEF	1.750	44.50	1.560	39.60	1.469	37.30	0.750	19.10	2.060	52.30	1.379	35.00
28	1.750 - 18 UNS	1.970	50.00	1.560	39.60					2.060	52.30	1.379	35.00

Note: All dimensions are in inches and millimeters (inch/mm). For complete dimensions, see the applicable Military Specification. Cable entry is defined as the envelope area of the cable or wire bundle. It is not intended for inspection criteria.

M85049 Backshells

AS85049/60-1 Series - Shrink boot adapter

For connectors:

MIL-DTL-5015 crimp

MIL-DTL-26482 Series 2

AS81703 Series 3

MIL-DTL-83723 Series 1 & 3

Ordering information

Basic Series	M85049/60-1	N	10
Material and plating			
A: Aluminum, black anodize			
N: Aluminum, electroless nickel			
W: Aluminum, olive drab cadmium over electroless nickel, 1000 hours salt spray			
Shell size			
3, 8, 10, 12, 14, 16, 18, 20, 22, 24, 28, 32, 36, 40, 44, 48, 61			

Dimensions



Shell size	A Thread Class 2B	B Max		C Max		D Max		Cable entry	
		inch	mm	inch	mm	inch	mm	inch	mm
3	0.562 - 24 UNEF	0.670	17.00	0.832	21.10	0.533	13.50	0.250	6.40
8	0.500 - 20 UNF	0.620	15.70			0.533	13.50	0.250	6.40
10	0.625 - 24 UNEF	0.740	18.80			0.605	15.40	0.355	9.00
12	0.750 - 20 UNEF	0.860	21.80			0.774	19.70	0.491	12.50
14	0.875 - 20 UNEF	0.980	24.90			0.838	21.30	0.565	14.40
16	1.000 - 20 UNEF	1.110	28.20			0.963	24.50	0.690	17.50
18	1.062 - 18 UNEF	1.220	31.00			1.042	26.50	0.769	19.50
20	1.188 - 18 UNEF	1.350	34.30			1.217	30.90	0.894	22.70
22	1.313 - 18 UNEF	1.470	37.30			1.355	34.40	1.019	25.90
24	1.438 - 18 UNEF	1.590	40.40			1.443	36.70	1.134	28.80
28	1.750 - 18 UNS	1.970	50.00	0.994	25.30	1.709	43.40	1.369	34.80
32	2.000 - 18 UNS	2.220	56.40			1.919	48.70	1.615	41.00
36	2.250 - 16 UN	2.470	62.70			2.169	55.10	1.830	46.50
40	2.500 - 16 UN	2.720	69.10			2.402	61.00	2.045	51.90
44	2.750 - 16 UN	2.970	75.40			2.657	67.50	2.300	58.40
48	3.000 - 16 UN	3.220	81.80			2.907	73.80	2.550	64.80
61	1.500 - 18 UNEF	1.650	41.90	0.832	21.10	1.529	38.80	1.174	29.80

Note: All dimensions are in inches and millimeters (inch/mm). For complete dimensions, see the applicable Military Specification. Cable entry is defined as the envelope area of the cable or wire bundle. It is not intended for inspection criteria.

M85049 Backshells

AS85049/62 Series - Shrink boot adapter

For connectors:

MIL-DTL-27599

MIL-DTL-38999 Series I & II

Ordering information

Basic Series	M85049/62	10	N	D
Shell size 8, 10, 12, 14, 16, 18, 20, 22, 24				
Material and plating A: Aluminum, black anodize N: Aluminum, electroless nickel S: Stainless steel, passivated W: Aluminum, olive drab cadmium over electroless nickel, 1000 hours salt spray				
Drain hole D: with drain hole empty: without drain hole				

Dimensions



Shell size	A Thread Class 2B	B Max		C Max		D Max		Cable entry	
		inch	mm	inch	mm	inch	mm	inch	mm
8	0.438 - 28 UNEF	0.750	19.10	1.000	25.40	0.533	13.50	0.250	6.40
10	0.562 - 24 UNEF	0.850	21.60			0.605	15.40	0.375	9.50
12	0.688 - 24 UNEF	1.000	25.40			0.774	19.70	0.500	12.70
14	0.813 - 20 UNEF	1.100	27.90			0.838	21.30	0.625	15.90
16	0.938 - 20 UNEF	1.250	31.80			0.963	24.50	0.750	19.10
18	1.063 - 18 UNEF	1.400	35.60			1.042	26.50	0.812	20.60
20	1.188 - 18 UNEF	1.500	38.10			1.217	30.90	0.937	23.80
22	1.313 - 18 UNEF	1.650	41.90			1.355	34.40	1.062	27.00
24	1.438 - 18 UNEF	1.750	44.50			1.443	36.70	1.188	30.20

Note: All dimensions are in inches and millimeters (inch/mm). For complete dimensions, see the applicable Military Specification. Cable entry is defined as the envelope area of the cable or wire bundle. It is not intended for inspection criteria.

M85049 Backshells

AS85049/69 Series - Shrink boot adapter

For connectors:

MIL-DTL-38999 Series III & IV

EN3645

Ordering information

Basic Series	M85049/69	11	N
Shell size	9, 11, 13, 15, 17, 19, 21, 23, 25		
Material and plating	<p>A: Aluminum, black anodize N: Aluminum, electroless nickel S: Stainless steel, passivated W: Aluminum, olive drab cadmium over electroless nickel, 1000 hours salt spray</p>		
Drain hole	<p>D: with drain hole empty: without drain hole</p>		

Dimensions



Shell size	A Thread Class 2B	B Max		C Max		D Max		Cable entry	
		inch	mm	inch	mm	inch	mm	inch	mm
9	M12 X 1 - 6H	0.750	19.10	0.710	18.00	0.533	13.50	0.250	6.40
11	M15 X 1 - 6H	0.850	21.60			0.605	15.40	0.375	9.50
13	M18 X 1 - 6H	1.000	25.40			0.774	19.70	0.500	12.70
15	M22 X 1 - 6H	1.150	29.20			0.838	21.30	0.625	15.90
17	M25 X 1 - 6H	1.250	31.80			0.963	24.50	0.750	19.10
19	M28 X 1 - 6H	1.400	35.60			1.042	26.50	0.812	20.60
21	M31 X 1 - 6H	1.500	38.10			1.217	30.90	0.938	23.80
23	M34 X 1 - 6H	1.650	41.90			1.355	34.40	1.062	27.00
25	M37 X 1 - 6H	1.785	47.00			1.443	36.70	1.188	30.20

Note: All dimensions are in inches and millimeters (inch/mm). For complete dimensions, see the applicable Military Specification. Cable entry is defined as the envelope area of the cable or wire bundle. It is not intended for inspection criteria.

M85049 Backshells

AS85049/82, 83, 84 Series - Banding backshell with self-locking

For connectors:

MIL-DTL-5015 crimp

MIL-DTL-26482 Series 2

AS81703 Series 3

MIL-DTL-83723 Series 1 & 3

Ordering information

Basic Series	AS85049/	82	-	10	N	02
Angle						
82: Straight						
83: 45°						
84: 90° (size 28 not qualified for AS85049/84)						
Self-locking option						
- : Detended						
N: Non detended						
Shell size: 8, 10, 12, 14, 16, 18, 20, 22, 24, 28 (size 28 not qualified for AS85049/84)						
Material and plating						
N: Aluminum, electroless nickel						
P: Aluminum, olive drab cadmium over electroless nickel with polysulfide sealant strips						
W: Aluminum, olive drab cadmium over electroless nickel, 1000 hours salt spray						
Entry size (see table below): 02, 03						

Dimensions



Shell size	A Thread Class 2B	B Max		C Max		D Max		E Max		F Max		Cable entry Size 02 ±0.01/0.30		Cable entry Size 03 ±0.01/0.30	
		inch	mm	inch	mm	inch	mm	inch	mm	inch	mm	inch	mm	inch	mm
8	0.500 - 20 UNF	0.886	22.40	0.870	22.10	1.160	29.50	1.188	30.20	1.417	36.00	N/A	N/A	0.250	6.40
10	0.625 - 24 UNEF	1.010	25.70	0.890	22.60	1.180	30.00	1.281	32.50	1.480	37.60	N/A	N/A	0.312	7.90
12	0.750 - 20 UNEF	1.130	28.70	0.920	23.40	1.200	30.50	1.406	35.70	1.542	39.20	0.312	7.90	0.438	11.10
14	0.875 - 20 UNEF	1.260	32.00	0.940	23.90	1.220	31.00	1.531	38.90	1.605	40.80	0.438	11.10	0.562	14.30
16	1.000 - 20 UNEF	1.386	35.10	0.960	24.40	1.250	31.80	1.656	42.10	1.667	42.30	0.500	12.70	0.625	15.90
18	1.062 - 18 UNEF	1.510	38.40	0.980	24.90	1.260	32.00	1.718	43.60	1.730	43.90	0.625	15.90	0.750	19.10
20	1.188 - 18 UNEF	1.636	41.40	1.000	25.40	1.290	32.80	1.844	46.80	1.792	45.50	0.625	15.90	0.812	20.60
22	1.313 - 18 UNEF	1.760	44.70	1.030	26.20	1.310	33.30	1.938	49.20	1.850	47.00	0.688	17.50	0.938	23.80
24	1.438 - 18 UNEF	1.886	47.80	1.050	26.70	1.340	34.00	2.093	53.20	1.917	48.70	0.750	19.10	1.000	25.40
28	1.750 - 18 UNS	2.136	54.10	1.100	27.90	1.380	35.10	2.531	64.30	2.042	51.90	0.875	22.20	1.125	28.60

Note: All dimensions are in inches and millimeters (inch/mm). For complete dimensions, see the applicable Military Specification. Cable entry is defined as the envelope area of the cable or wire bundle. It is not intended for inspection criteria.

M85049 Backshells

AS85049/85, 86, 87 Series - Banding backshell with self-locking

For connectors:

MIL-DTL-27599

MIL-DTL-38999 Series I & II

Ordering information

Basic Series	AS85049/	85	-	10	N	02
Angle						
85: Straight						
86: 45°						
87: 90°						
Self-locking option						
- : Detended						
N: Non detended						
Shell size: 8, 10, 12, 14, 16, 18, 20, 22, 24						
Material and plating						
N: Aluminum, electroless nickel						
P: Aluminum, olive drab cadmium over electroless nickel with polysulfide sealant strips						
W: Aluminum, olive drab cadmium over electroless nickel, 1000 hours salt spray						
Entry size (see table below): 02, 03						

Dimensions

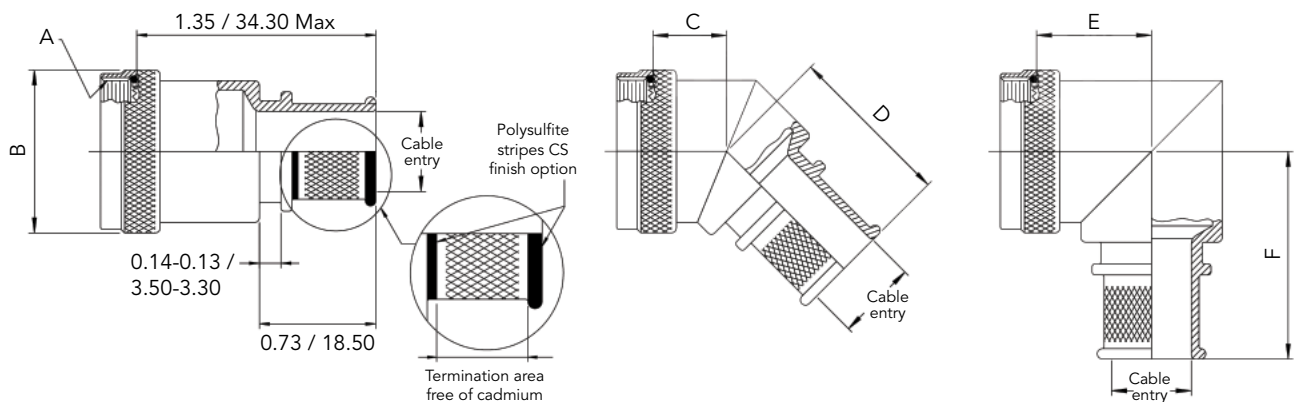

Shell size	A Thread Class 2B	B Max		C Max		D Max		E Max		F Max		Cable entry for AS85049/85, Straight version				Cable entry for AS85049/86 and AS85049/87, 45° & 90°			
												Size 01		Size 02		Size 02		Size 03	
		inch	mm	inch	mm	inch	mm	inch	mm	inch	mm	inch	mm	inch	mm	inch	mm	inch	mm
8	0.438-28 UNEF	0.860	21.80	0.870	22.10	1.160	29.50	1.375	34.90	1.417	36.00	N/A	N/A	0.250	6.40	N/A	N/A	0.250	6.40
10	0.562-24 UNEF	0.990	25.10	0.900	22.90	1.190	30.20	1.437	36.50	1.480	37.60	N/A	N/A	0.312	7.90	N/A	N/A	0.312	7.90
12	0.688-24 UNEF	1.160	29.50	0.920	23.40	1.210	30.70	1.562	39.70	1.553	39.40	0.312	7.90	0.438	11.10	0.312	7.90	0.438	11.10
14	0.812-20 UNEF	1.280	32.50	0.950	24.10	1.240	31.50	1.687	42.80	1.614	41.00	0.438	11.10	0.562	14.30	0.438	11.10	0.562	14.30
16	0.938-20 UNEF	1.410	35.80	0.980	24.90	1.260	32.00	1.750	44.50	1.678	42.60	0.500	12.70	0.625	15.90	0.500	12.70	0.625	15.90
18	1.062-18 UNEF	1.520	38.60	0.980	24.90	1.270	32.30	1.875	47.60	1.733	44.00	0.625	15.90	0.750	19.10	0.625	15.90	0.750	19.10
20	1.188-18 UNEF	1.640	41.70	1.010	25.70	1.300	33.00	1.938	49.20	1.796	45.60	0.625	15.90	0.812	20.60	0.625	15.90	0.812	20.60
22	1.312-18 UNEF	1.770	45.00	1.040	26.40	1.330	33.80	2.062	52.40	1.859	47.20	0.688	17.50	0.938	23.80	0.688	17.50	0.938	23.80
24	1.438-18 UNEF	1.890	48.00	1.070	27.20	1.350	34.30	2.125	54.00	1.919	48.70	0.750	19.10	1.000	25.40	0.750	19.10	1.000	25.40

Note: All dimensions are in inches and millimeters (inch/mm). For complete dimensions, see the applicable Military Specification. Cable entry is defined as the envelope area of the cable or wire bundle. It is not intended for inspection criteria.

M85049 Backshells

AS85049/88, 89, 90 Series - Banding backshell with self-locking

For connectors:

MIL-DTL-38999 Series III & IV

EN3645

Ordering information

Basic Series	AS85049/	88	-	11	N	02
Angle						
88: Straight						
89: 45°						
90: 90°						
Self-locking option						
- : Detended						
N: Non detended						
Shell size: 9, 11, 13, 15, 17, 19, 21, 23, 25						
Material and plating						
N: Aluminum, electroless nickel						
P: Aluminum, olive drab cadmium over electroless nickel with polysulfide sealant strips						
W: Aluminum, olive drab cadmium over electroless nickel, 1000 hours salt spray						
Entry size (see table below): 02, 03						

Dimensions

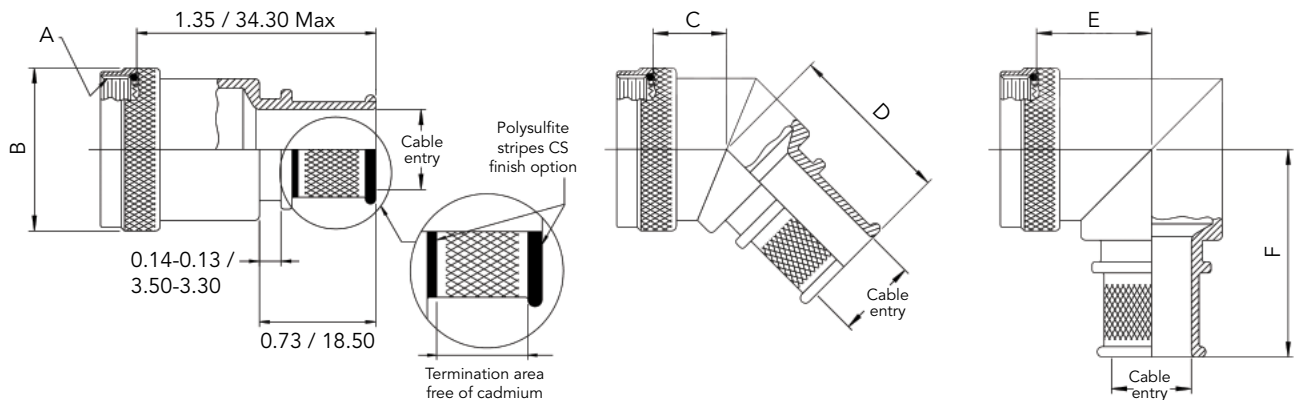

Shell size	A Thread Class 2B	B Max		C Max		D Max		E Max		F Max		Cable entry Size 02		Cable entry Size 03	
		inch	mm	inch	mm	inch	mm	inch	mm	inch	mm	inch	mm	inch	mm
9	M12X1-6H	0.860	21.80	1.010	25.70	1.160	29.50	1.375	34.90	1.417	36.00	N/A	N/A	0.250	6.40
11	M15X1-6H	0.990	25.10	1.030	26.20	1.190	30.20	1.437	36.50	1.480	37.60	N/A	N/A	0.312	7.90
13	M18X1-6H	1.160	29.50	1.060	26.90	1.210	30.70	1.562	39.70	1.553	39.40	0.312	7.90	0.438	11.10
15	M22X1-6H	1.280	32.50	1.080	27.40	1.240	31.50	1.687	42.80	1.614	41.00	0.438	11.10	0.562	14.30
17	M25X1-6H	1.410	35.80	1.110	28.20	1.260	32.00	1.750	44.50	1.678	42.60	0.500	12.70	0.625	15.90
19	M28X1-6H	1.520	38.60	1.120	28.40	1.270	32.30	1.875	47.60	1.733	44.00	0.625	15.90	0.750	19.10
21	M31X1-6H	1.640	41.70	1.150	29.20	1.300	33.00	1.938	49.20	1.796	45.60	0.625	15.90	0.812	20.60
23	M34X1-6H	1.770	45.00	1.170	29.70	1.330	33.80	2.062	52.40	1.859	47.20	0.688	17.50	0.938	23.80
25	M37X1-6H	1.890	48.00	1.200	30.50	1.350	34.30	2.125	54.00	1.919	48.70	0.750	19.10	1.000	25.40

Note: All dimensions are in inches and millimeters (inch/mm). For complete dimensions, see the applicable Military Specification. Cable entry is defined as the envelope area of the cable or wire bundle. It is not intended for inspection criteria.

M85049 Backshells

M85049/93 Series - Shield support ring

For **ALL** connectors.

Ordering information

Basic Series	M85049/93	10
Dash number	4, 6, 8, 10, 12, 14, 16, 18, 20, 22, 24, 26, 28	

Dimensions



Dash number	X		Y		Z	
	inch	mm	inch	mm	inch	mm
4	0.25	6.40	0.404	10.30	0.36	9.10
6	0.38	9.70	0.529	13.40	0.49	12.40
8	0.50	12.70	0.654	16.60	0.61	15.50
10	0.63	16.00	0.779	19.80	0.74	18.80
12	0.75	19.10	0.904	23.00	0.86	21.80
14	0.88	22.40	1.029	26.10	0.99	25.10
16	1.00	25.40	1.154	29.30	1.11	28.20
18	1.13	28.70	1.279	32.50	1.24	31.50
20	1.25	21.80	1.404	35.70	1.36	34.50
22	1.38	35.10	1.529	38.90	1.49	37.80
24	1.50	38.10	1.654	42.00	1.61	40.90
26	1.63	41.40	1.779	45.20	1.74	44.20
28	1.75	44.50	1.904	48.60	1.86	47.20

Note: All dimensions are in inches and millimeters (inch/mm). For complete dimensions, see the applicable Military Specification.

Protective Caps

MS27501/MS27502 Series - Protective caps for plug and receptacle

For connectors:
MIL-DTL-38999 Series I

Ordering information

Basic Series	MS27	501	B	11	N
Cap type					
501: Cap for plug					
502: Cap for receptacle					
Material and plating					
B: Aluminum, olive drab cadmium, 500 hours salt spray					
C: Aluminum, black anodize					
F: Aluminum, electroless nickel					
Shell size: 9, 11, 13, 15, 17, 19, 21, 23, 25					
Style					
A: Without chain					
C: Chain with eyelet					
N: Chain with ring (MS27502 only)					
Chain length (in inches/mm)					
empty: Standard chain length, see table below (C Max)					
L: 5.0/127.0					
M: 6.0/152.4 (MS27501 only)					
N: 7.0/177.8 (MS27501 only)					

Dimensions

Cap for plug Type 501



Cap for receptacle Type 502



Size	ØA Max		ØB Max		C Max		ØD Min	
	inch	mm	inch	mm	inch	mm	inch	mm
9	0.82	20.80	0.82	20.80	3.00	76.20	0.70	17.80
11	0.94	23.90	0.94	23.90			0.84	21.30
13	1.07	27.20	1.10	27.90	3.50	88.90	1.01	25.70
15	1.19	30.20	1.22	31.00			1.14	29.00
17	1.35	33.50	1.34	34.00			1.26	32.00
19	1.44	36.60	1.46	37.10	4.00	101.60	1.39	35.30
21	1.57	39.90	1.58	40.10			1.51	38.40
23	1.69	42.90	1.70	43.20			1.64	41.70
25	1.82	46.20	1.83	46.50			1.76	44.70

Note: All dimensions are in inches and millimeters (inch/mm).

Protective Caps

D38999 Series - Protective caps for plug and receptacle

For connectors:
MIL-DTL-38999 Series III

Ordering information

Basic Series	D38999/	32	W	11	N
Cap type					
32: Cap for plug					
33: Cap for receptacle					
Material and plating					
W: Aluminum, olive drab cadmium					
F: Aluminum, nickel					
Z: Aluminum, black zinc nickel					
Shell size: 9, 11, 13, 15, 17, 19, 21, 23, 25					
Style					
N: With stainless steel rope and ring					
R: With stainless steel rope and eyelet					

Dimensions

Cap for plug Type 32



Cap for receptacle Type 33



Size	ØA Max		ØB Max		C Max		ØD		ØE		Thread: Stub ACME 2A/2B modified 60°
	inch	mm	inch	mm	inch	mm	inch	mm	inch	mm	
9	0.889	22.60	0.898	22.80	3.31	84.00	0.591	15.00	0.724	18.40	0.6250-0.1P-0.3L-TS
11	1.016	25.80	1.043	26.50			0.724	18.40	0.913	23.20	0.7500-0.1P-0.3L-TS
13	1.181	30.00	1.181	30.00	3.90	99.00	0.913	23.20	1.043	26.50	0.8750-0.1P-0.3L-TS
15	1.299	33.00	1.252	31.80			0.913	23.20	1.193	30.30	1.0000-0.1P-0.3L-TS
17	1.437	36.50	1.449	36.80			1.043	26.50	1.283	32.60	1.1875-0.1P-0.3L-TS
19	1.543	39.20	1.528	38.80	4.49	114.00	1.193	30.30	1.437	36.50	1.2500-0.1P-0.3L-TS
21	1.673	42.50	1.646	41.80			1.283	32.60	1.547	39.30	1.3750-0.1P-0.3L-TS
23	1.803	45.80	1.764	44.80			1.437	36.50	1.689	42.90	1.5000-0.1P-0.3L-TS
25	1.925	48.90	1.921	48.80			1.547	39.30	1.772	45.00	1.6250-0.1P-0.3L-TS

Note: All dimensions are in inches and millimeters (inch/mm).

For further information contact us at sunbank.sales@esterline.com
or visit our web site www.sunbankcorp.com

Компания «Океан Электроники» предлагает заключение долгосрочных отношений при поставках импортных электронных компонентов на взаимовыгодных условиях!

Наши преимущества:

- Поставка оригинальных импортных электронных компонентов напрямую с производств Америки, Европы и Азии, а так же с крупнейших складов мира;
- Широкая линейка поставок активных и пассивных импортных электронных компонентов (более 30 млн. наименований);
- Поставка сложных, дефицитных, либо снятых с производства позиций;
- Оперативные сроки поставки под заказ (от 5 рабочих дней);
- Экспресс доставка в любую точку России;
- Помощь Конструкторского Отдела и консультации квалифицированных инженеров;
- Техническая поддержка проекта, помощь в подборе аналогов, поставка прототипов;
- Поставка электронных компонентов под контролем ВП;
- Система менеджмента качества сертифицирована по Международному стандарту ISO 9001;
- При необходимости вся продукция военного и аэрокосмического назначения проходит испытания и сертификацию в лаборатории (по согласованию с заказчиком);
- Поставка специализированных компонентов военного и аэрокосмического уровня качества (Xilinx, Altera, Analog Devices, Intersil, Interpoint, Microsemi, Actel, Aeroflex, Peregrine, VPT, Syfer, Eurofarad, Texas Instruments, MS Kennedy, Miteq, Cobham, E2V, MA-COM, Hittite, Mini-Circuits, General Dynamics и др.);

Компания «Океан Электроники» является официальным дистрибьютором и эксклюзивным представителем в России одного из крупнейших производителей разъемов военного и аэрокосмического назначения «JONHON», а так же официальным дистрибьютором и эксклюзивным представителем в России производителя высокотехнологичных и надежных решений для передачи СВЧ сигналов «FORSTAR».



JONHON

«JONHON» (основан в 1970 г.)

Разъемы специального, военного и аэрокосмического назначения:

(Применяются в военной, авиационной, аэрокосмической, морской, железнодорожной, горно- и нефтедобывающей отраслях промышленности)

«FORSTAR» (основан в 1998 г.)

ВЧ соединители, коаксиальные кабели, кабельные сборки и микроволновые компоненты:

(Применяются в телекоммуникациях гражданского и специального назначения, в средствах связи, РЛС, а так же военной, авиационной и аэрокосмической отраслях промышленности).



Телефон: 8 (812) 309-75-97 (многоканальный)

Факс: 8 (812) 320-03-32

Электронная почта: ocean@oceanchips.ru

Web: <http://oceanchips.ru/>

Адрес: 198099, г. Санкт-Петербург, ул. Калинина, д. 2, корп. 4, лит. А