

EAO – Your Expert Partner for
Human Machine Interfaces



EAO Product Information

Series 18



Description	3
Product Assembly	4
Devices raised mounting	5
Devices flush mounting	6
Accessories.....	7
Technical Data.....	10
Drawings.....	11
Index.....	15

Product Information

General notes

The series 18 comprises compact indicators for direct connection to 2.2, 12 or 24 VDC and illuminated pushbuttons with maintained or momentary action.

The illuminated pushbuttons are equipped with a snap-action switching system with normally open or normally closed contacts.

The dimensions of the front are 9 x 14 mm, 9 x 9 mm or 9 mm dia.

Indicators and illuminated pushbuttons for use with overhanging lenses 14 x 14 mm or 14 mm dia. are also available for flush mounting.

Mounting

Mounting from the front through the mounting hole 8 mm dia.

(15.8 x 15.8 mm resp. 16 mm dia. for flush mounting) is assured even with the wiring already attached.

The units are provided with soldering terminals.

Lenses

The flat lenses are available in various colours and a transparent version. The surface is nonreflecting (matt).

Illumination

Perfect illumination of the lenses, which can be supplied in various colours, is assured by Bi-Pin T1 LEDs (2.2 VDC) in the colours red, yellow and green.

(Compact indicators for connection to 12 or 24 VDC.) The Bi-Pin T1 LED are already integrated in the lenses.

Luminosity and wave length scattering caused by the technology used in the LED manufacturing processes may lead to visual differences in our products.

Position indication

The status of a maintained action switch can be determined by the position of the lens.

Specimen order

Illuminated pushbutton :

- Illuminated pushbutton actuator, 9 x14 mm, momentary action, 1 normally open, soldering terminal 18-147.035

Essential accessories :

- Lens with LED plastic yellow, transparent, flush, 9 x 14 mm 18-941.4

We reserve the right to modify technical data

All dimensions in mm

Pushbutton illuminative, raised mounting

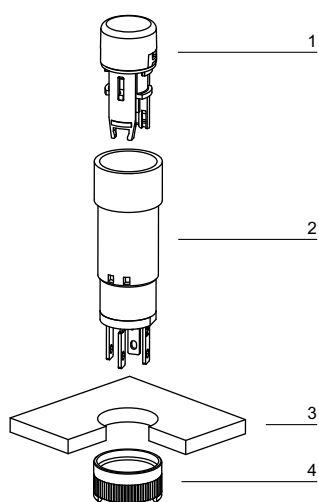

- 1 Lens
- 2 Switch housing
- 3 Front panel
- 4 Fixing nut

Pushbutton illuminative, flush mounting



- 1 Lens
- 2 Switch housing
- 3 Front bezel set (upper part)
- 4 Front panel
- 5 Front bezel set (lower part)
- 6 Fixing nut

Indicator



	Front protection	Operating voltage/-current	Lens	Terminals	9 x 9 mm Typ-Nr.	9 x 14 mm Typ-Nr.	Ø 9 mm Typ-Nr.	Component layout	Mounting dimensions	Technical drawing	Circuit drawing	
Indicator	IP 40	12 VDC, 20 mA	Plastic green	S	18-051.0055	18-041.0055	18-031.0055	1	1	1	1	0.002
			Plastic red	S	18-051.0052	18-041.0052	18-031.0052	1	1	1	1	0.002
			Plastic yellow	S	18-051.0054	18-041.0054	18-031.0054	1	1	1	1	0.002
		2.2 VDC, 20 mA	Plastic green	S	18-050.0055	18-040.0055	18-030.0055	1	1	1	1	0.002
			Plastic red	S	18-050.0052	18-040.0052	18-030.0052	1	1	1	1	0.002
			Plastic yellow	S	18-050.0054	18-040.0054	18-030.0054	1	1	1	1	0.002
		24 VDC, 20 mA	Plastic green	S	18-052.0055	18-042.0055	18-032.0055	1	1	1	1	0.002
			Plastic red	S	18-052.0052	18-042.0052	18-032.0052	1	1	1	1	0.002
			Plastic yellow	S	18-052.0054	18-042.0054	18-032.0054	1	1	1	1	0.002

Terminals: S = Soldering terminal

Component layout from page 11, Mounting dimensions from page 12, Technical drawing from page 12, Circuit drawing from page 13

Illuminated pushbutton actuator



Essential Accessories:

Lens with LED page 7

	Front protection	Switching system	Contacts	Switching action	Terminals	9 x 9 mm Typ-Nr.	9 x 14 mm Typ-Nr.	Ø 9 mm Typ-Nr.	Component layout	Mounting dimensions	Technical drawing	Circuit drawing	
Illuminated pushbutton actuator	IP 40	SA	1 NC	MA	S	18-258.035	18-248.035	18-238.035	2	1	2	2	0.002
				M	S	18-158.035	18-148.035	18-138.035	2	1	2	4	0.002
			1 NO	MA	S	18-257.035	18-247.035	18-237.035	2	1	2	3	0.002
				M	S	18-157.035	18-147.035	18-137.035	2	1	2	5	0.002

Switching system: SA = Snap-action switching element

Contacts: NC = Normally closed, NO = Normally open

Switching action: MA = Maintained action, M = Momentary action

Terminals: S = Soldering terminal

Component layout from page 11, Mounting dimensions from page 12, Technical drawing from page 12, Circuit drawing from page 13

Indicator actuator, flush mounting



Essential Accessories:

Front bezel set, flush mounting page 8

	Front protection	Operating voltage/-current	Lens	Terminals	□ 19 x 19 mm Typ-Nr.	∅ 19 mm Typ-Nr.	Component layout	Mounting dimensions	Technical drawing	Circuit drawing	
Indicator actuator, flush mounting	IP 40	12 VDC, 20 mA	Plastic green	S	18-081.0055	18-061.0055	2	2	3	1	0.003
			Plastic red	S	18-081.0052	18-061.0052	2	2	3	1	0.003
			Plastic yellow	S	18-081.0054	18-061.0054	2	2	3	1	0.003
		2.2 VDC, 20 mA	Plastic green	S	18-080.0055	18-060.0055	2	2	3	1	0.002
			Plastic red	S	18-080.0052	18-060.0052	2	2	3	1	0.002
			Plastic yellow	S	18-080.0054	18-060.0054	2	2	3	1	0.002
		24 VDC, 20 mA	Plastic green	S	18-082.0055	18-062.0055	2	2	3	1	0.003
			Plastic red	S	18-082.0052	18-062.0052	2	2	3	1	0.003
			Plastic yellow	S	18-082.0054	18-062.0054	2	2	3	1	0.003

Terminals: S = Soldering terminal

Component layout from page 11, Mounting dimensions from page 12, Technical drawing from page 12, Circuit drawing from page 13

Illuminated pushbutton actuator, flush mounting



Essential Accessories:

Front bezel set, flush mounting page 8

Lens with LED, flush mounting page 7

	Front protection	Switching system	Contacts	Switching action	Terminals	□ 19 x 19 mm Typ-Nr.	∅ 19 mm Typ-Nr.	Component layout	Mounting dimensions	Technical drawing	Circuit drawing	
Illuminated pushbutton actuator, flush mounting	IP 40	SA	1 NC	MA	S	18-288.035	18-268.035	2	2	4	2	0.002
				M	S	18-188.035	18-168.035	2	2	4	4	0.002
			1 NO	MA	S	18-287.035	18-267.035	2	2	4	3	0.002
				M	S	18-187.035	18-167.035	2	2	4	5	0.002

Switching system: SA = Snap-action switching element

Contacts: NC = Normally closed, NO = Normally open

Switching action: MA = Maintained action, M = Momentary action

Terminals: S = Soldering terminal

Component layout from page 11, Mounting dimensions from page 12, Technical drawing from page 12, Circuit drawing from page 13

Front

Lens without LED

	Lens	∅ 9 x 9 mm Typ-Nr.	∅ 9 x 14 mm Typ-Nr.	∅ 9 mm Typ-Nr.	
Lens without LED illuminative	Plastic green translucent flush	18-952.5	18-942.5	18-932.5	0.001
	Plastic red translucent flush	18-952.2	18-942.2	18-932.2	0.001
	Plastic white translucent flush	18-952.9	18-942.9	18-932.9	0.001
	Plastic yellow translucent flush	18-952.4	18-942.4	18-932.4	0.001
non-illuminative	Plastic black opaque flush	18-952.0	18-942.0	18-932.0	0.001
	Plastic grey opaque flush	18-952.8	18-942.8	18-932.8	0.001



Lens with LED

	Lens	∅ 9 x 9 mm Typ-Nr.	∅ 9 x 14 mm Typ-Nr.	∅ 9 mm Typ-Nr.	
Lens with LED without built-in series resistor, typ. forward voltage 2.2 VDC, 20 mA	Plastic green translucent flush	18-951.5	18-941.5	18-931.5	0.001
	Plastic red translucent flush	18-951.2	18-941.2	18-931.2	0.001
	Plastic yellow translucent flush	18-951.4	18-941.4	18-931.4	0.001



Lens without LED, flush mounting

	Lens	∅ 19 x 19 mm Typ-Nr.	∅ 19 mm Typ-Nr.	
Lens without LED, flush mounting illuminative	Plastic green translucent flush	18-982.5	18-962.5	0.001
	Plastic red translucent flush	18-982.2	18-962.2	0.001
	Plastic white translucent flush	18-982.9	18-962.9	0.001
	Plastic yellow translucent flush	18-982.4	18-962.4	0.001
non-illuminative	Plastic black opaque flush	18-982.0	18-962.0	0.001
	Plastic grey opaque flush	18-982.8	18-962.8	0.001



Lens with LED, flush mounting

	Lens	∅ 19 x 19 mm Typ-Nr.	∅ 19 mm Typ-Nr.	
Lens with LED, flush mounting without built-in series resistor, typ. forward voltage 2.2 VDC, 20 mA	Plastic green translucent flush	18-981.5	18-961.5	0.001
	Plastic red translucent flush	18-981.2	18-961.2	0.001
	Plastic yellow translucent flush	18-981.4	18-961.4	0.001



Front bezel set, flush mounting

	Front bezel	Ø 19 x 19 mm Typ-Nr.	Ø 19 mm Typ-Nr.	Mounting dimensions	
Front bezel set, flush mounting for Lens round	Plastic black	18-920.2	18-920.3	2	0.006
for Lens square	Plastic black	18-920.1		2	0.006



Mounting dimensions from page 12

Blind plug

		Ø 9 x 9 mm Typ-Nr.	Ø 9 mm Typ-Nr.	Mounting dimensions	
Blind plug		19-948.0	19-949.0	3	0.001



Mounting dimensions from page 12

Backside

PCB plug-in base

	Terminals	Typ-Nr.	Component layout	Technical drawing	
PCB plug-in base Pins axial	P	18-945	3	5	0.001
Pins bent at right-angles	P	18-946	4	6	0.001



Terminals: P = PCB terminal

Component layout from page 11, Technical drawing from page 12

Assembling

Lens remover

	Typ-Nr.	
Lens remover	18-910	0.002



Mounting tool

	Typ-Nr.	
Mounting tool for Fixing nut long 19-991	19-905	0.011



Actuator with snap-action switching element

Switching system

The snap-action switching system was designed for switching low powers in electronic circuits.
Single-break snap-action contact.

Material

Lens

Polymethylacrylate (PMMA), Polycarbonate (PC)

Material of contact

Gold contact on nickel plating

Actuator housing

Polyamide, colour black

Mechanical characteristics

Terminals

The terminals can be used as soldering terminals.
Max.wire diameter: 2 x 0.5 mm²
Max.wire ccross-section of stranded cable 1 x 0.75 mm²
Wire cross-section of terminal 1.6 x 0.4 mm

Tightening torque

for fixing nut max. 20 Ncm

Actuating force

1.4 N

Actuating travel

2.2 mm ±0.2 mm

Rebound time

≤2.5 ms

Mechanical lifetime

Momentary action 2 million cycles of operation
Maintained action 1 million cycles of operation,
as per IEC 60512-5-9a

Electrical characteristics

Contact resistance

≤100 mΩ starting value (initial), as per IEC 60512-2-2b

Electrical life

≥500 000 cycles of operation at 30 VDC, 100 mA, as per IEC 60512-5-9c

Power consumption LED

20 mA

Switch rating

min. 10 μA at 100 μV
max. 100 mA at 42 VAC/VDC

Electric strength

500 VAC, 50 Hz, 1 min. between all terminals and earth, as per IEC 60512-2-11

Environmental conditions

Storage temperature

-40 °C ... +80 °C

Service temperature

-25 °C ... +65 °C

Protection degree

IP 40 front side, as per IEC 60529

Shock resistance

(Single impacts, semi-sinusoidal)
50 g for 11 ms, as per IEC 60068-2-27

Vibration resistance

(sinusoidal)10 g at 10-2000 Hz, amplitude 0.75 mm, as per IEC 60512-4-4

Approvals

Declaration of conformity

RoHS

Component layout

1 Indicator page 5

9 x 9 mm

9 x 14 mm

Ø9 mm



2 Illuminated pushbutton actuator page 5 | Indicator actuator, flush mounting page 6 | Illuminated pushbutton actuator, flush mounting page 6

9 x 9 mm

9 x 14 mm

Ø9 mm

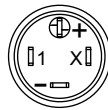
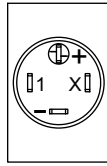

X contact-nr.
2 = NO
4 = NC

3 PCB plug-in base page 8

Drilling plan (element side)
Through-connection recommended



4 PCB plug-in base page 8

Drilling plan (element side)
Through-connection recommended



Mounting dimensions

1 Indicator page 5 | Illuminated pushbutton actuator page 5



2 Indicator actuator, flush mounting page 6 | Illuminated pushbutton actuator, flush mounting page 6 | Front bezel set, flush mounting page 8



3 Blind plug page 8



Technical drawing

1 Indicator page 5

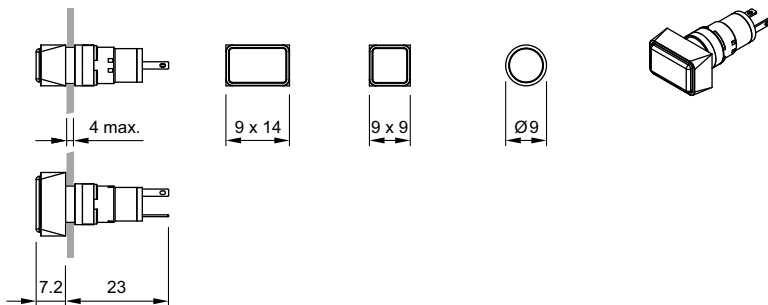

2 Illuminated pushbutton actuator page 5

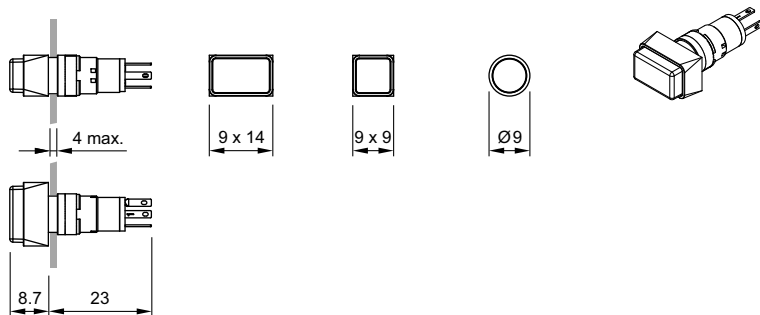

3 Indicator actuator, flush mounting page 6

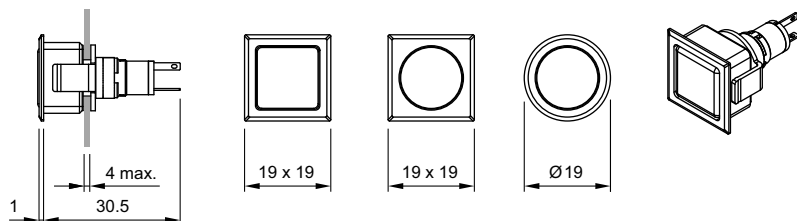

4 Illuminated pushbutton actuator, flush mounting page 6

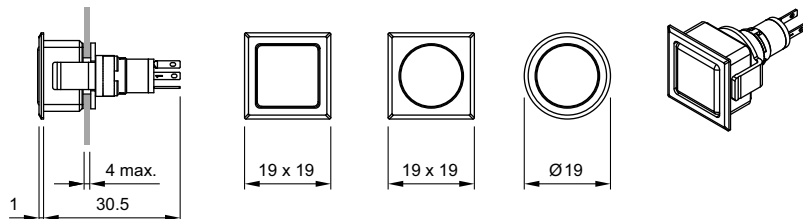

5 PCB plug-in base page 8

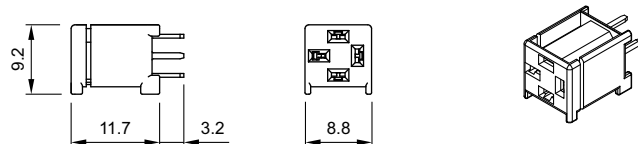

6 PCB plug-in base page 8

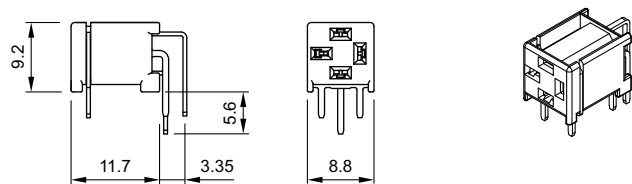

Circuit drawing

1 Indicator page 5 | Indicator actuator, flush mounting page 6



2 Illuminated pushbutton actuator page 5 | **Illuminated pushbutton actuator, flush mounting** page 6



3 Illuminated pushbutton actuator page 5 | **Illuminated pushbutton actuator, flush mounting** page 6



4 Illuminated pushbutton actuator page 5 | **Illuminated pushbutton actuator, flush mounting** page 6



5 Illuminated pushbutton actuator page 5 | **Illuminated pushbutton actuator, flush mounting** page 6



Index from Typ-Nr.

Typ-Nr.	Page	Typ-Nr.	Page	Typ-Nr.	Page
18-030.0052	5	18-287.035	6		
18-030.0054	5	18-288.035	6		
18-030.0055	5	18-910	8		
18-031.0052	5	18-920.1	8		
18-031.0054	5	18-920.2	8		
18-031.0055	5	18-920.3	8		
18-032.0052	5	18-931.2	7		
18-032.0054	5	18-931.4	7		
18-032.0055	5	18-931.5	7		
18-040.0052	5	18-932.0	7		
18-040.0054	5	18-932.2	7		
18-040.0055	5	18-932.4	7		
18-041.0052	5	18-932.5	7		
18-041.0054	5	18-932.8	7		
18-041.0055	5	18-932.9	7		
18-042.0052	5	18-941.2	7		
18-042.0054	5	18-941.4	7		
18-042.0055	5	18-941.5	7		
18-050.0052	5	18-942.0	7		
18-050.0054	5	18-942.2	7		
18-050.0055	5	18-942.4	7		
18-051.0052	5	18-942.5	7		
18-051.0054	5	18-942.8	7		
18-051.0055	5	18-942.9	7		
18-052.0052	5	18-945	8		
18-052.0054	5	18-946	8		
18-052.0055	5	18-951.2	7		
18-060.0052	6	18-951.4	7		
18-060.0054	6	18-951.5	7		
18-060.0055	6	18-952.0	7		
18-061.0052	6	18-952.2	7		
18-061.0054	6	18-952.4	7		
18-061.0055	6	18-952.5	7		
18-062.0052	6	18-952.8	7		
18-062.0054	6	18-952.9	7		
18-062.0055	6	18-961.2	7		
18-080.0052	6	18-961.4	7		
18-080.0054	6	18-961.5	7		
18-080.0055	6	18-962.0	7		
18-081.0052	6	18-962.2	7		
18-081.0054	6	18-962.4	7		
18-081.0055	6	18-962.5	7		
18-082.0052	6	18-962.8	7		
18-082.0054	6	18-962.9	7		
18-082.0055	6	18-981.2	7		
18-137.035	5	18-981.4	7		
18-138.035	5	18-981.5	7		
18-147.035	5	18-982.0	7		
18-148.035	5	18-982.2	7		
18-157.035	5	18-982.4	7		
18-158.035	5	18-982.5	7		
18-167.035	6	18-982.8	7		
18-168.035	6	18-982.9	7		
18-187.035	6	19-905	9		
18-188.035	6	19-948.0	8		
18-237.035	5	19-949.0	8		
18-238.035	5				
18-247.035	5				
18-248.035	5				
18-257.035	5				
18-258.035	5				
18-267.035	6				
18-268.035	6				

	EAO AG
	Tannwaldstrasse 88 4601 Olten, Switzerland
E-mail	info@eao.com
Website	www.eao.com
	Austria
Phone	+49 201 85 87 0
Fax	+49 201 85 87 210
E-mail	sales.ede@eao.com
	Belgium
Phone	+32 3 777 82 36
Fax	+32 3 777 84 19
E-mail	sales.ebl@eao.com
	China
Phone	+852 27 86 91 41
Fax	+852 27 86 95 61
E-mail	sales.ehk@eao.com
	France
Phone	+33 1 64 43 37 37
Fax	+33 1 64 43 37 49
E-mail	sales.esa@eao.com
	Germany
Phone	+49 201 85 87 0
Fax	+49 201 85 87 210
E-mail	sales.ede@eao.com
	Italy
Phone	+39 035 481 0189
Fax	+39 035 481 3786
E-mail	sales.eit@eao.com
	Japan
Phone	+81 3 5444 5411
Fax	+81 3 5444 0345
E-mail	sales.esj@eao.com
	Netherlands
Phone	+31 78 653 17 00
Fax	+31 78 653 17 99
E-mail	sales.enl@eao.com
	Sweden
Phone	+46 8 683 86 60
Fax	+46 8 724 29 12
E-mail	sales.esw@eao.com
	Switzerland
Phone	+41 62 388 95 00
Fax	+41 62 388 95 55
E-mail	sales.ech@eao.com
	United Kingdom
Phone	+44 1444 236 000
Fax	+44 1444 236 641
E-mail	sales.euk@eao.com
	USA
Phone	+1 203 877 4577
Fax	+1 203 877 3694
E-mail	sales.eus@eao.com
	Other Countries
Phone	+41 62 286 92 10
Fax	+41 62 296 21 62
E-mail	info@eao.com

Компания «Океан Электроники» предлагает заключение долгосрочных отношений при поставках импортных электронных компонентов на взаимовыгодных условиях!

Наши преимущества:

- Поставка оригинальных импортных электронных компонентов напрямую с производств Америки, Европы и Азии, а так же с крупнейших складов мира;
- Широкая линейка поставок активных и пассивных импортных электронных компонентов (более 30 млн. наименований);
- Поставка сложных, дефицитных, либо снятых с производства позиций;
- Оперативные сроки поставки под заказ (от 5 рабочих дней);
- Экспресс доставка в любую точку России;
- Помощь Конструкторского Отдела и консультации квалифицированных инженеров;
- Техническая поддержка проекта, помощь в подборе аналогов, поставка прототипов;
- Поставка электронных компонентов под контролем ВП;
- Система менеджмента качества сертифицирована по Международному стандарту ISO 9001;
- При необходимости вся продукция военного и аэрокосмического назначения проходит испытания и сертификацию в лаборатории (по согласованию с заказчиком);
- Поставка специализированных компонентов военного и аэрокосмического уровня качества (Xilinx, Altera, Analog Devices, Intersil, Interpoint, Microsemi, Actel, Aeroflex, Peregrine, VPT, Syfer, Eurofarad, Texas Instruments, MS Kennedy, Miteq, Cobham, E2V, MA-COM, Hittite, Mini-Circuits, General Dynamics и др.);

Компания «Океан Электроники» является официальным дистрибьютором и эксклюзивным представителем в России одного из крупнейших производителей разъемов военного и аэрокосмического назначения «JONHON», а так же официальным дистрибьютором и эксклюзивным представителем в России производителя высокотехнологичных и надежных решений для передачи СВЧ сигналов «FORSTAR».



JONHON

«JONHON» (основан в 1970 г.)

Разъемы специального, военного и аэрокосмического назначения:

(Применяются в военной, авиационной, аэрокосмической, морской, железнодорожной, горно- и нефтедобывающей отраслях промышленности)

«FORSTAR» (основан в 1998 г.)

ВЧ соединители, коаксиальные кабели, кабельные сборки и микроволновые компоненты:

(Применяются в телекоммуникациях гражданского и специального назначения, в средствах связи, РЛС, а так же военной, авиационной и аэрокосмической отраслях промышленности).



Телефон: 8 (812) 309-75-97 (многоканальный)

Факс: 8 (812) 320-03-32

Электронная почта: ocean@oceanchips.ru

Web: <http://oceanchips.ru/>

Адрес: 198099, г. Санкт-Петербург, ул. Калинина, д. 2, корп. 4, лит. А