

# PS9031

R08DS0131EJ0200

Rev.2.00

Mar 11, 2016

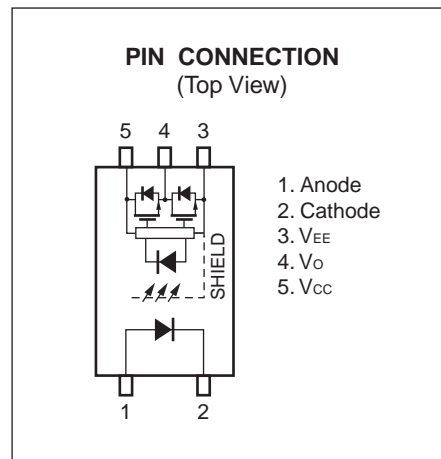
2.5 A OUTPUT CURRENT, HIGH CMR, IGBT GATE DRIVE,  
5-PIN SOP (LSO5 WITH 8mm CREEPAGE DISTANCE) PHOTOCOUPLER

## DESCRIPTION

The PS9031 is an optically coupled isolator containing a GaAlAs LED on the input side and a photodiode, a signal processing circuit and power MOSFETs on the output side on one chip.

## FEATURES

- Long creepage distance (8 mm MIN.)
- Large peak output current (2.5 A MAX., 2.0 A MIN.)
- High speed switching ( $t_{PLH}$ ,  $t_{PHL}$  = 175 ns MAX.)
- UVLO (Under Voltage Lock Out) protection with hysteresis
- High common mode transient immunity ( $CM_H$ ,  $CM_L$  =  $\pm 50$  kV/ $\mu$ s MIN.)
- Operating Ambient Temperature (125 °C MAX.)
- Embossed tape product : PS9031-F3 : 3000 pcs/reel
- Pb-Free product
- Safety standards
  - UL approved: UL1577, Double protection
  - CSA approved: CA5A, CAN/CSA-C22.2 No.60065, CAN/CSA-C22.2 No.60950-1, Reinforced insulation
  - VDE approved: DIN EN 60747-5-5 (Option)



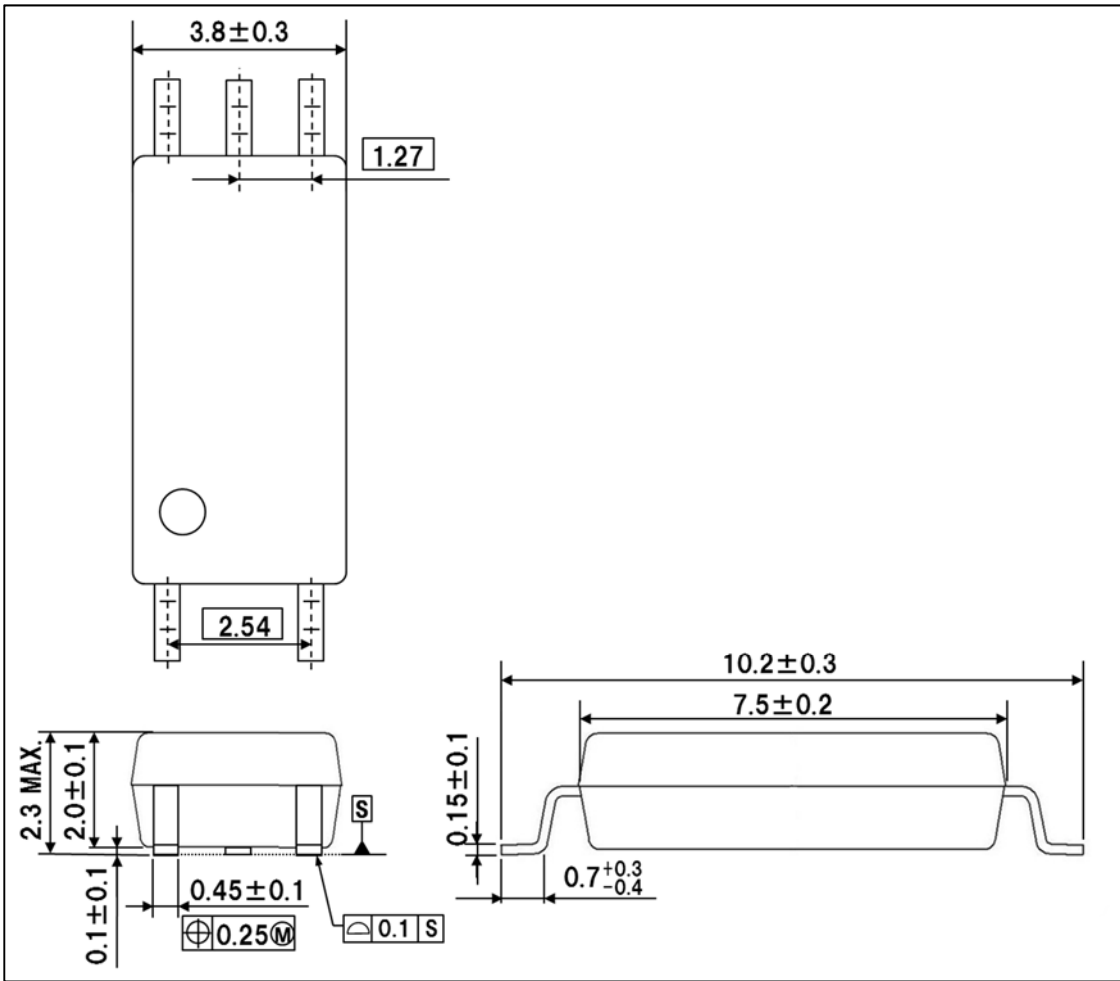
## APPLICATIONS

- IGBT, Power MOS FET Gate Driver
- Industrial inverter
- AC Servo

Start of mass production

Oct.2015

**PACKAGE DIMENSIONS (UNIT: mm)**

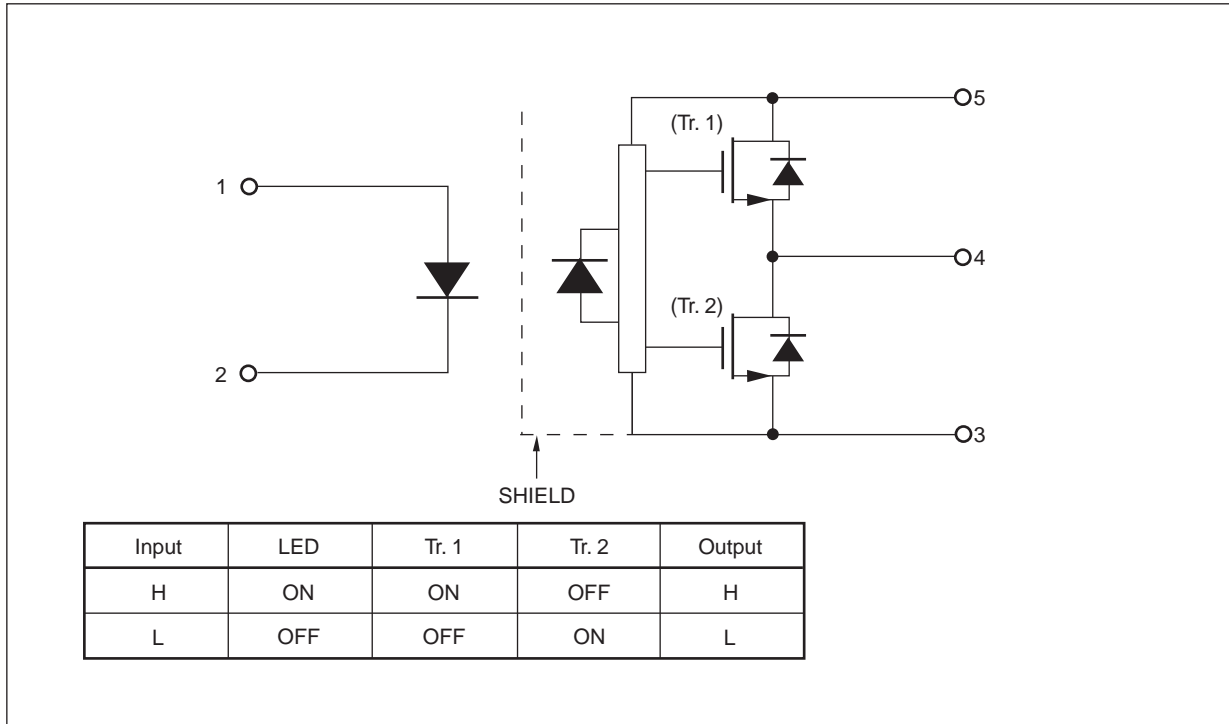


Weight: 0.119g (typ.)

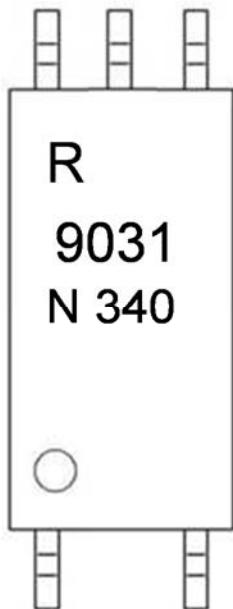
**PHOTOCOUPLER CONSTRUCTION**

Parameter	MIN.
Air Distance	8.0 mm
Outer Creepage Distance	8.0 mm
Isolation Distance	0.15 mm

**BLOCK DIAGRAM**



**MARKING EXAMPLE**



R	An initial of "Renesas"	
9031	Product Part Number	
○	No.1 pin Mark, Anode Mark	
N340	N	Rank Code
		340
	3	Last one-digit of Assembly Year
		40

## ORDERING INFORMATION

Part Number	Order Number	Solder Plating Specification	Packing Style	Safety Standard Approval	Application Part Number <sup>*1</sup>
PS9031	PS9031-Y-AX	Pb-Free and Halogen Free (Ni/Pd/Au)	20 pcs (Tape 20 pcs cut)	Standard products (UL, CSA approved)	PS9031
PS9031-F3	PS9031-Y-F3-AX		Embossed Tape 3 000 pcs/reel		
PS9031-V	PS9031-Y-V-AX		20 pcs (Tape 20 pcs cut)	UL, CSA approved DIN EN 60747-5-5 (VDE 0884-5): 2011-11 approved (Option)	
PS9031-V-F3	PS9031-Y-V-F3-AX		Embossed Tape 3 000 pcs/reel		

Note: \*1. For the application of the Safety Standard, following part number should be used.

ABSOLUTE MAXIMUM RATINGS ( $T_A = 25^\circ\text{C}$ , unless otherwise specified)

Parameter		Symbol	Ratings	Unit
Diode	Forward Current	$I_F$	25	mA
	Peak Transient Forward Current (Pulse Width < 1 $\mu\text{s}$ )	$I_{F(\text{TRAN})}$	1.0	A
	Reverse Voltage	$V_R$	5	V
	Power Dissipation <sup>*1</sup>	$P_D$	45	mW
Detector	High Level Peak Output Current <sup>*2</sup>	$I_{OH(\text{PEAK})}$	2.5	A
	Low Level Peak Output Current <sup>*2</sup>	$I_{OL(\text{PEAK})}$	2.5	A
	Supply Voltage	$(V_{CC} - V_{EE})$	0 to 35	V
	Output Voltage	$V_O$	0 to $V_{CC}$	V
	Power Dissipation <sup>*3</sup>	$P_C$	250	mW
Isolation Voltage <sup>*4</sup>		BV	5 000	Vr.m.s.
Operating Frequency		f	200	kHz
Operating Ambient Temperature		$T_A$	-40 to +125	$^\circ\text{C}$
Storage Temperature		$T_{\text{stg}}$	-55 to +150	$^\circ\text{C}$

Notes: \*1. Reduced to 1.2 mW/ $^\circ\text{C}$  at  $T_A = 110^\circ\text{C}$  or more.

\*2. Maximum pulse width = 10  $\mu\text{s}$ , Maximum duty cycle = 0.2%

\*3. Reduced to 3.9 mW/ $^\circ\text{C}$  at  $T_A = 90^\circ\text{C}$  or more.

\*4. AC voltage for 1 minute at  $T_A = 25^\circ\text{C}$ , RH = 60% between input and output.

Pins 1-2 shorted together, 3-5 shorted together.

## RECOMMENDED OPERATING CONDITIONS

Parameter	Symbol	MIN.	TYP.	MAX.	Unit
Supply Voltage	$(V_{CC} - V_{EE})$	15		30	V
Forward Current (ON)	$I_{F(\text{ON})}$	8	10	12	mA
Forward Voltage (OFF)	$V_{F(\text{OFF})}$	-2		0.8	V
Operating Ambient Temperature	$T_A$	-40		125	$^\circ\text{C}$

**ELECTRICAL CHARACTERISTICS**(at RECOMMENDED OPERATING CONDITIONS,  $V_{EE}=GND$ , unless otherwise Specified)

Parameter		Symbol	Conditions	MIN.	TYP.*1	MAX.	Unit
Diode	Forward Voltage	$V_F$	$I_F = 10 \text{ mA}$ , $T_A = 25^\circ\text{C}$	1.35	1.56	1.75	V
	Reverse Current	$I_R$	$V_R = 3 \text{ V}$ , $T_A = 25^\circ\text{C}$			10	$\mu\text{A}$
	Input Capacitance	$C_{IN}$	$f = 1 \text{ MHz}$ , $V_F = 0 \text{ V}$		30		pF
Detector	High Level Output Current	$I_{OH}$	$V_O = (V_{CC} - 4 \text{ V})^{*2}$	0.5	2.2		A
			$V_O = (V_{CC} - 15 \text{ V})^{*3}$	2.0			
	Low Level Output Current	$I_{OL}$	$V_O = (V_{EE} + 2.5 \text{ V})^{*2}$	0.5	2.4		A
			$V_O = (V_{EE} + 15 \text{ V})^{*3}$	2.0			
	High Level Output Voltage	$V_{OH}$	$I_O = -100 \text{ mA}^{*4}$	$V_{CC} - 3.0$	$V_{CC} - 1.3$		V
	Low Level Output Voltage	$V_{OL}$	$I_O = 100 \text{ mA}$		0.2	0.5	V
	High Level Supply Current	$I_{CCH}$	$V_O = \text{Open}$ , $I_F = 10 \text{ mA}$		1.7	2.2	mA
	Low Level Supply Current	$I_{CCL}$	$V_O = \text{Open}$ , $V_F = 0 \text{ to } 0.8\text{V}$		1.7	2.2	mA
	UVLO Threshold	$V_{UVLO+}$	$V_O > 5 \text{ V}$ , $I_F = 10 \text{ mA}$	10.8	12.3	13.4	V
$V_{UVLO-}$		9.5		11.0	12.5		
UVLO Hysteresis	$UVLO_{HYS}$	$V_O > 5 \text{ V}$ , $I_F = 10 \text{ mA}$	0.4	1.3		V	
Coupled	Threshold Input Current (L $\rightarrow$ H)	$I_{FLH}$	$I_O = 0 \text{ mA}$ , $V_O > 5 \text{ V}$		1.7	4.0	mA
	Threshold Input Voltage (H $\rightarrow$ L)	$V_{FHL}$	$I_O = 0 \text{ mA}$ , $V_O < 5 \text{ V}$	0.8			V

Notes: \*1. Typical values at  $T_A = 25^\circ\text{C}$ ,  $V_{CC} - V_{EE} = 30 \text{ V}$ .\*2. Maximum pulse width = 50  $\mu\text{s}$ , Maximum duty cycle = 0.5%.\*3. Maximum pulse width = 10  $\mu\text{s}$ , Maximum duty cycle = 0.2%.\*4.  $V_{OH}$  is measured with the DC load current in this testing (Maximum pulse width = 2 ms, Maximum duty cycle = 20%).**SWITCHING CHARACTERISTICS**(at RECOMMENDED OPERATING CONDITIONS,  $V_{EE}=GND$ , unless otherwise specified)

Parameter	Symbol	Conditions	MIN.	TYP.*1	MAX.	Unit	
Propagation Delay Time (L $\rightarrow$ H)	$t_{PLH}$	$R_g = 10 \Omega$ , $C_g = 10 \text{ nF}$ , $f = 10 \text{ kHz}$ , Duty Cycle = 50%, $I_F = 10 \text{ mA}$		80	175	ns	
Propagation Delay Time (H $\rightarrow$ L)	$t_{PHL}$			105	175	ns	
Pulse Width Distortion (PWD)	$ t_{PHL} - t_{PLH} $				25	75	ns
Propagation Delay Time (Difference Between Any Two Products)	$t_{PHL} - t_{PLH}$			-90		90	ns
Rise Time	$t_r$				40		ns
Fall Time	$t_f$				40		ns
Common Mode Transient Immunity at High Level Output	$ CM_H $		$T_A = 25^\circ\text{C}$ , $I_F = 10 \text{ mA}$ , $V_{CC} = 30 \text{ V}$ , $V_{CM} = 1.5 \text{ kV}$	50			$\text{kV}/\mu\text{s}$
Common Mode Transient Immunity at Low Level Output	$ CM_L $	$T_A = 25^\circ\text{C}$ , $I_F = 0 \text{ mA}$ , $V_{CC} = 30 \text{ V}$ , $V_{CM} = 1.5 \text{ kV}$	50			$\text{kV}/\mu\text{s}$	

Notes: \*1. Typical values at  $T_A = 25^\circ\text{C}$ ,  $V_{CC} - V_{EE} = 30 \text{ V}$ .

TEST CIRCUIT

Fig. 1  $I_{OH}$  Test Circuit

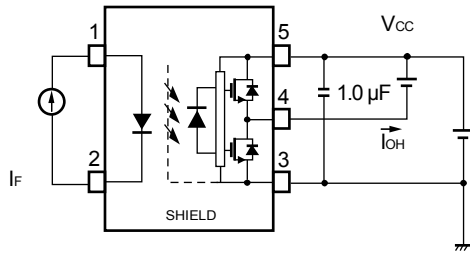


Fig. 2  $I_{OL}$  Test Circuit

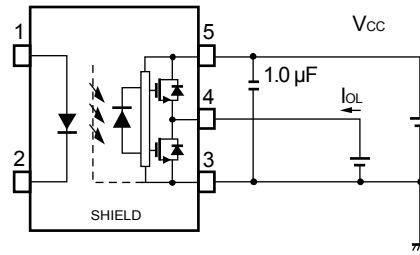


Fig. 3  $V_{OH}$  Test Circuit

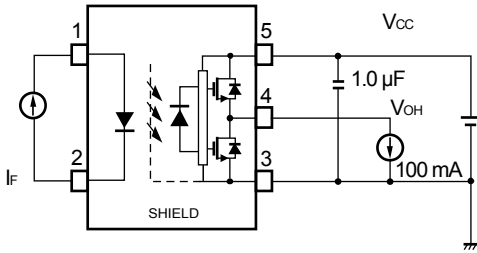


Fig. 4  $V_{OL}$  Test Circuit

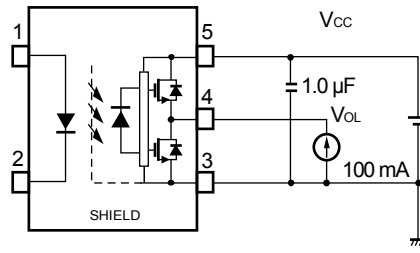


Fig. 5  $I_{CCH}/I_{CCL}$  Test Circuit

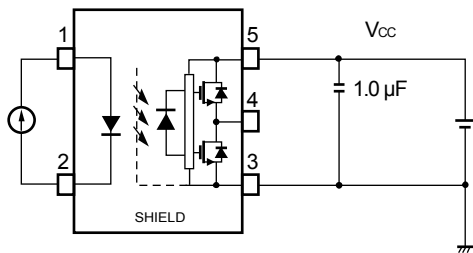
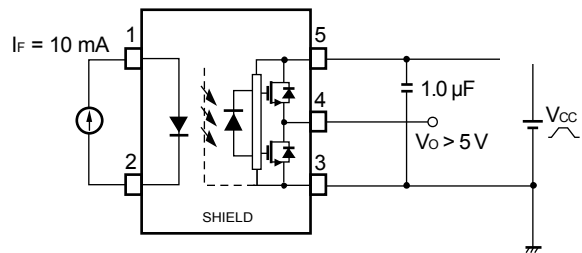
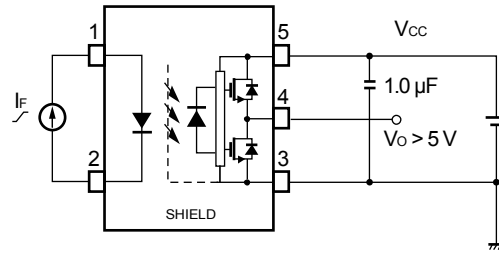


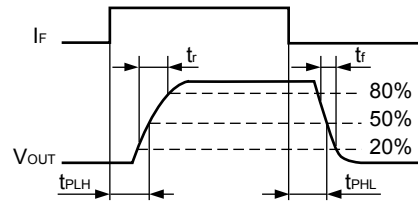
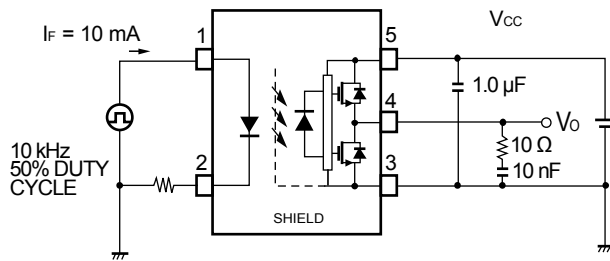
Fig. 6 UVLO Test Circuit



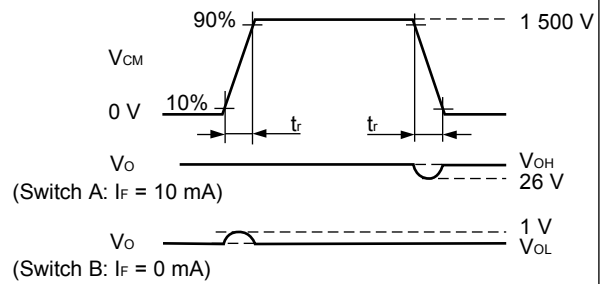
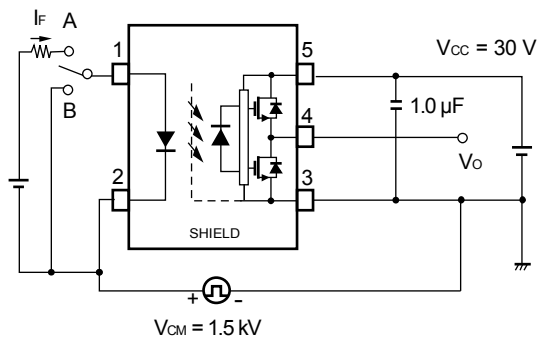
**Fig. 7 IFLH Test Circuit**



**Fig. 8 t<sub>PLH</sub>, t<sub>PHL</sub>, t<sub>r</sub>, t<sub>f</sub> Test Circuit and Wave Forms**

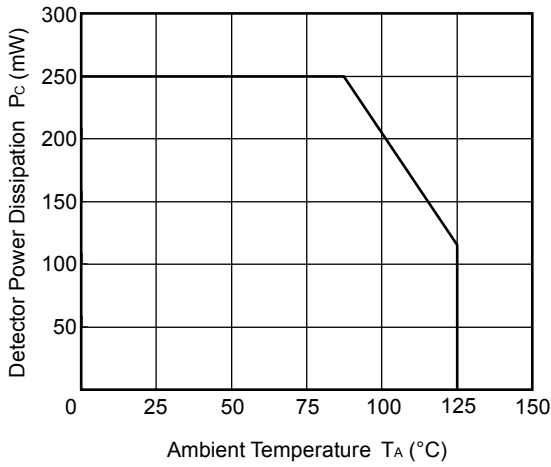


**Fig. 9 CMR Test Circuit and Wave Forms**

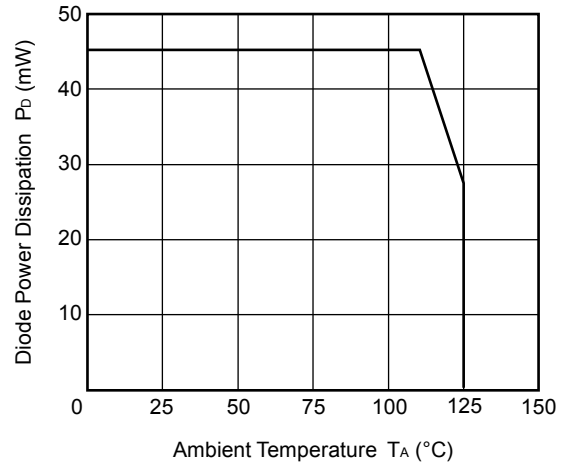


**TYPICAL CHARACTERISTICS (T<sub>A</sub> = 25°C, unless otherwise specified)**

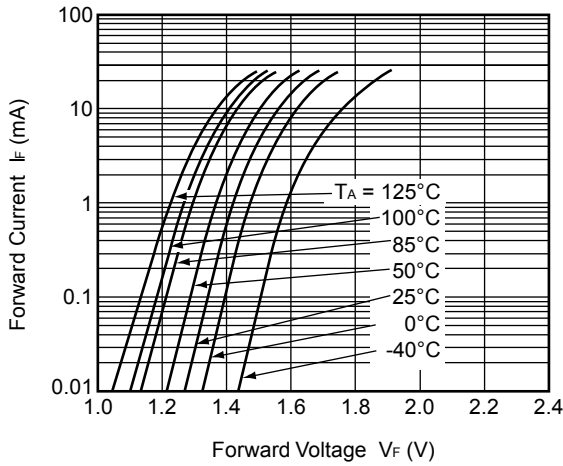
**DETECTOR POWER DISSIPATION vs. AMBIENT TEMPERATURE**



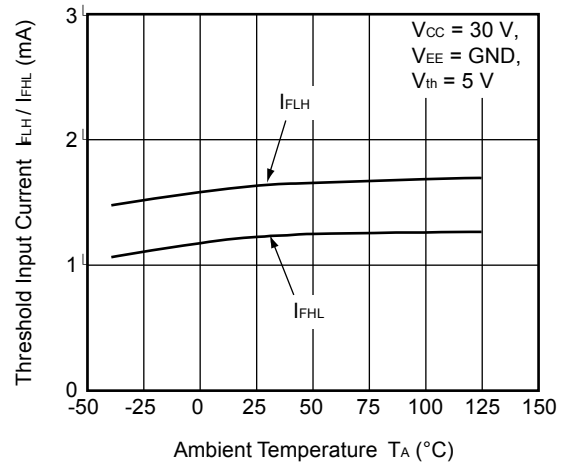
**DIODE POWER DISSIPATION vs. AMBIENT TEMPERATURE**



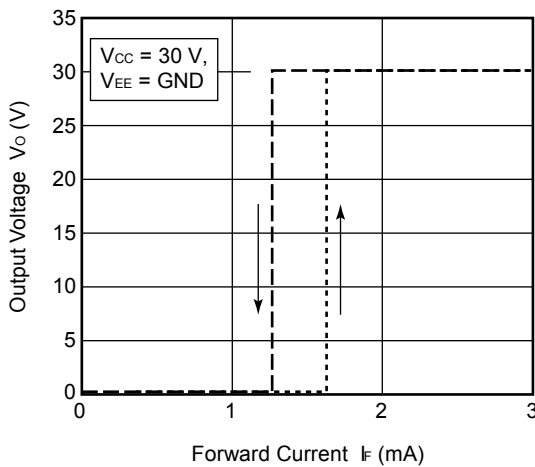
**FORWARD CURRENT vs. FORWARD VOLTAGE**



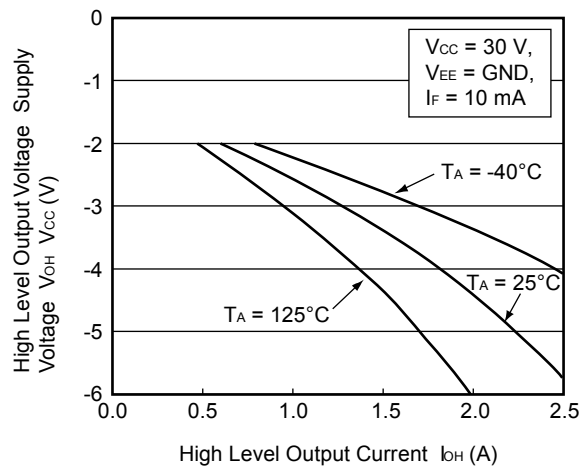
**THRESHOLD INPUT CURRENT vs. AMBIENT TEMPERATURE**



**OUTPUT VOLTAGE vs. FORWARD CURRENT**



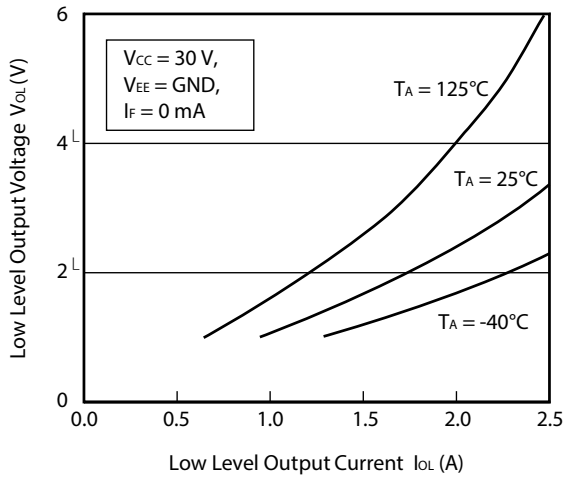
**HIGH LEVEL OUTPUT VOLTAGE vs. HIGH LEVEL OUTPUT CURRENT**



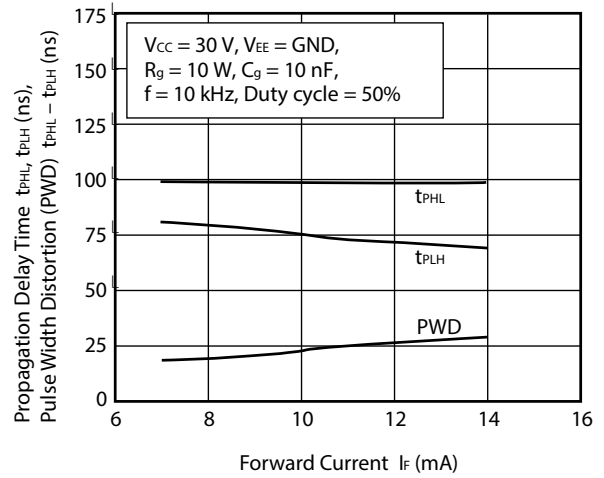
**Remark** The graphs indicate nominal characteristics.



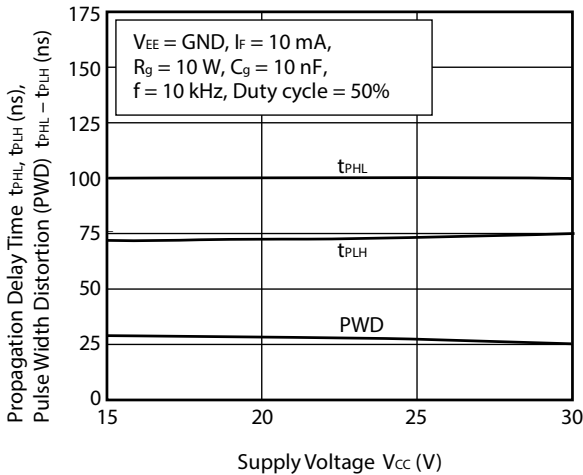
LOW LEVEL OUTPUT VOLTAGE vs. LOW LEVEL OUTPUT CURRENT



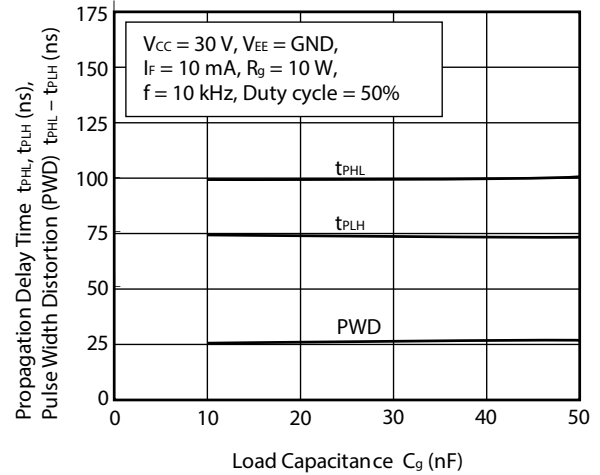
PROPAGATION DELAY TIME, PULSE WIDTH DISTORTION vs. FORWARD CURRENT



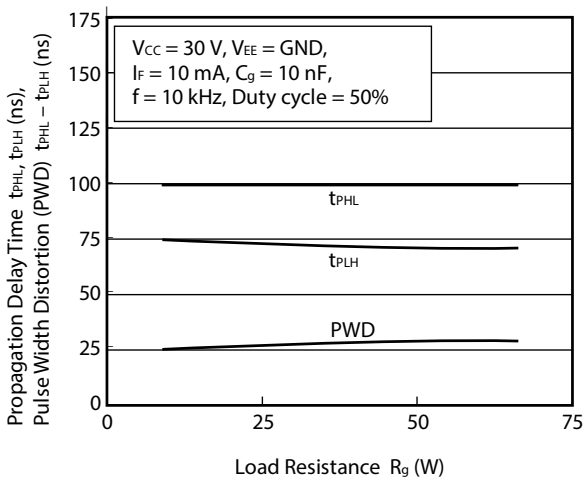
PROPAGATION DELAY TIME, PULSE WIDTH DISTORTION vs. SUPPLY VOLTAGE



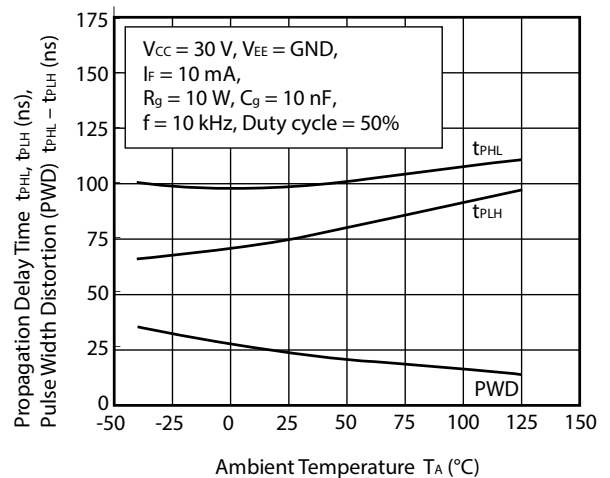
PROPAGATION DELAY TIME, PULSE WIDTH DISTORTION vs. LOAD CAPACITANCE



PROPAGATION DELAY TIME, PULSE WIDTH DISTORTION vs. LOAD RESISTANCE

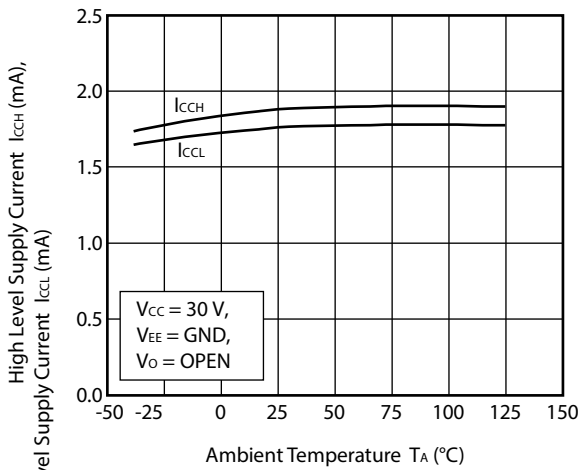


PROPAGATION DELAY TIME, PULSE WIDTH DISTORTION vs. AMBIENT TEMPERATURE

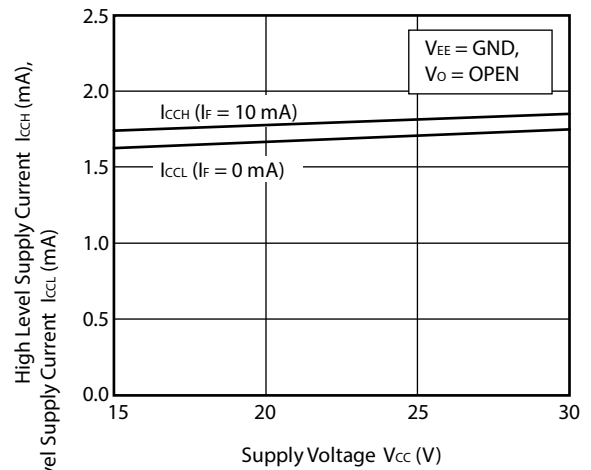


**Remark** The graphs indicate nominal characteristics.

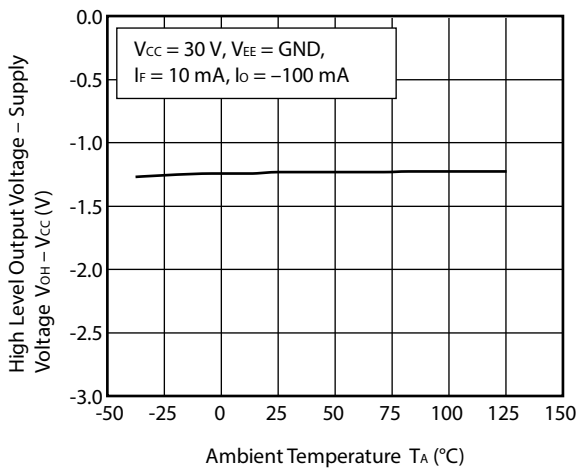
SUPPLY CURRENT vs. AMBIENT TEMPERATURE



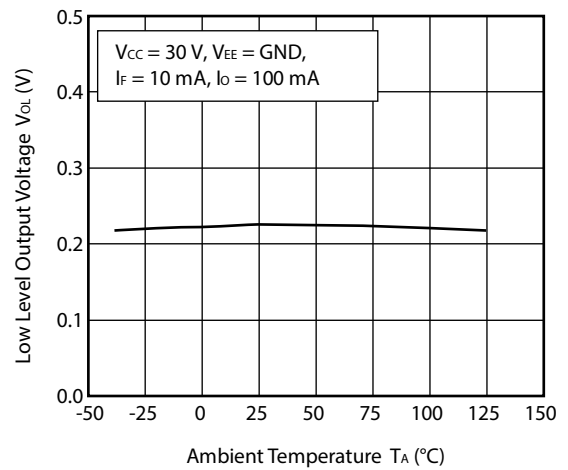
SUPPLY CURRENT vs. SUPPLY VOLTAGE



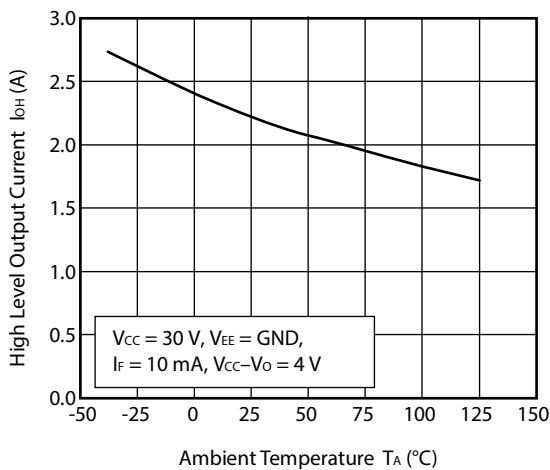
HIGH LEVEL OUTPUT VOLTAGE – SUPPLY VOLTAGE vs. AMBIENT TEMPERATURE



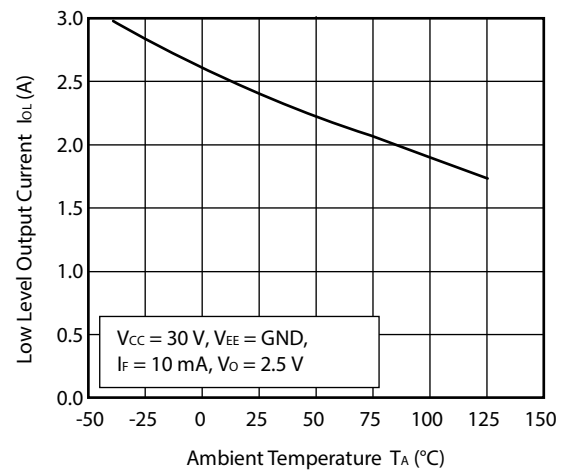
LOW LEVEL OUTPUT VOLTAGE vs. AMBIENT TEMPERATURE



HIGH LEVEL OUTPUT CURRENT vs. AMBIENT TEMPERATURE

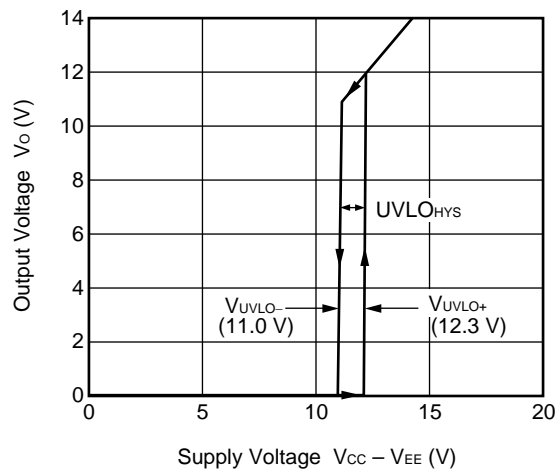


LOW LEVEL OUTPUT CURRENT vs. AMBIENT TEMPERATURE



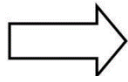
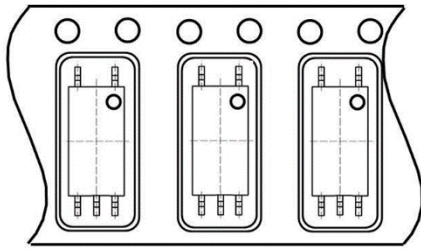
**Remark** The graphs indicate nominal characteristics.

## OUTPUT VOLTAGE vs. SUPPLY VOLTAGE



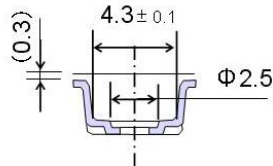
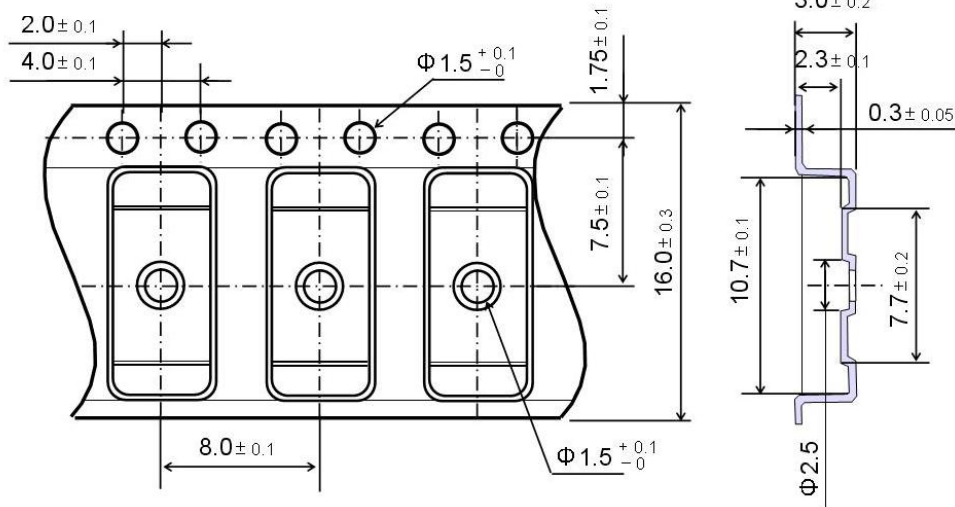
**Remark** The graphs indicate nominal characteristics.

TAPING SPECIFICATIONS (UNIT: mm)

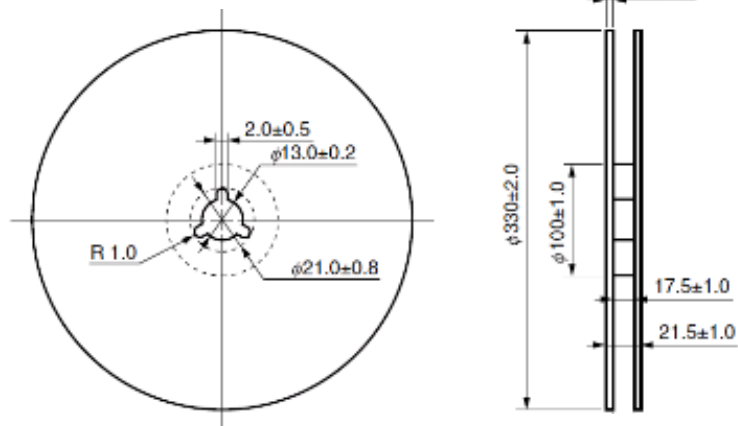


Tape Direction

Outline and Dimensions (Taps)

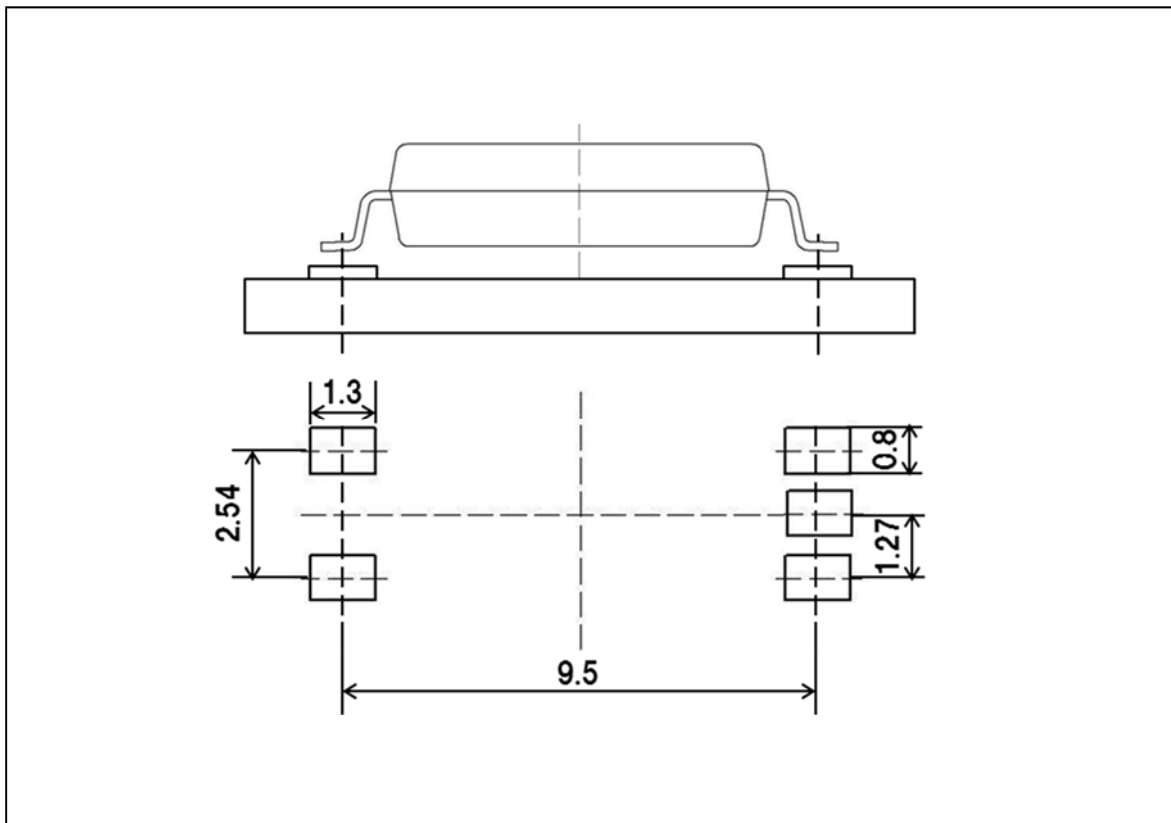


Outline and Dimensions (Reel)



Packing: 3000 pcs/reel

## RECOMMENDED MOUNT PAD DIMENSIONS (UNIT: mm)



**Remark** All dimensions in this figure must be evaluated before use.

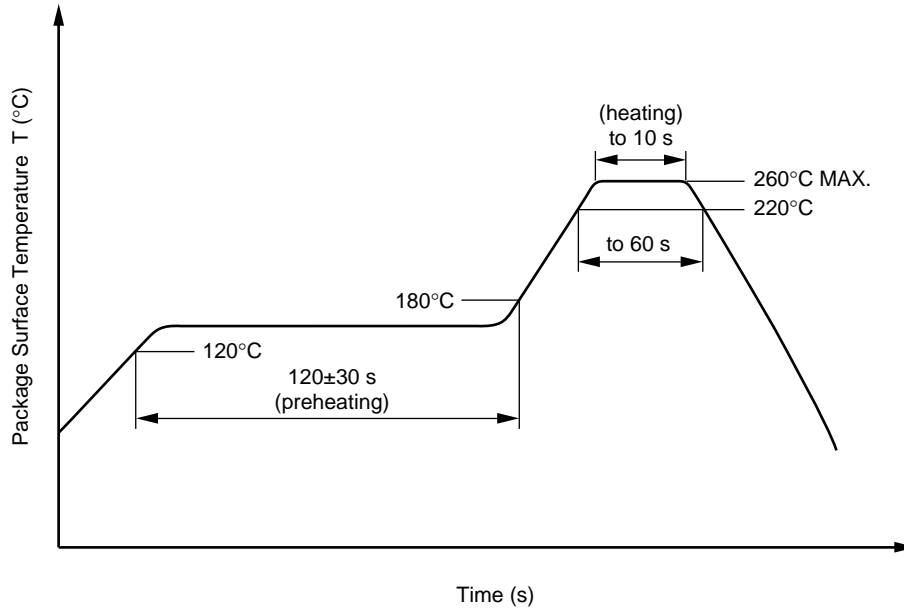
## NOTES ON HANDLING

### 1. Recommended soldering conditions

#### (1) Infrared reflow soldering

- Peak reflow temperature 260°C or below (package surface temperature)
- Time of peak reflow temperature 10 seconds or less
- Time of temperature higher than 220°C 60 seconds or less
- Time to preheat temperature from 120 to 180°C 120±30 s
- Number of reflows Three
- Flux Rosin flux containing small amount of chlorine (The flux with a maximum chlorine content of 0.2 Wt% is recommended.)

Recommended Temperature Profile of Infrared Reflow



#### (2) Wave soldering

- Temperature 260°C or below (molten solder temperature)
- Time 10 seconds or less
- Preheating conditions 120°C or below (package surface temperature)
- Number of times One (Allowed to be dipped in solder including plastic mold portion.)
- Flux Rosin flux containing small amount of chlorine (The flux with a maximum chlorine content of 0.2 Wt% is recommended.)

#### (3) Soldering by Soldering Iron

- Peak Temperature (lead part temperature) 350°C or below
- Time (each pins) 3 seconds or less
- Flux Rosin flux containing small amount of chlorine (The flux with a maximum chlorine content of 0.2 Wt% is recommended.)

(a) Soldering of leads should be made at the point 1.5 to 2.0 mm from the root of the lead

#### (4) Cautions

- Fluxes Avoid removing the residual flux with freon-based and chlorine-based cleaning solvent.

### 2. Cautions regarding noise

Be aware that when voltage is applied suddenly between the photocoupler's input and output at startup, the output transistor may enter the on state, even if the voltage is within the absolute maximum ratings.

## USAGE CAUTIONS

1. This product is weak for static electricity by designed with high-speed integrated circuit so protect against static electricity when handling.
2. Board designing
  - (1) By-pass capacitor of more than 1.0  $\mu\text{F}$  is used between VCC and GND near device. Also, ensure that the distance between the leads of the photocoupler and capacitor is no more than 10 mm.
  - (2) When designing the printed wiring board, ensure that the pattern of the IGBT collectors/emitters is not too close to the input block pattern of the photocoupler.

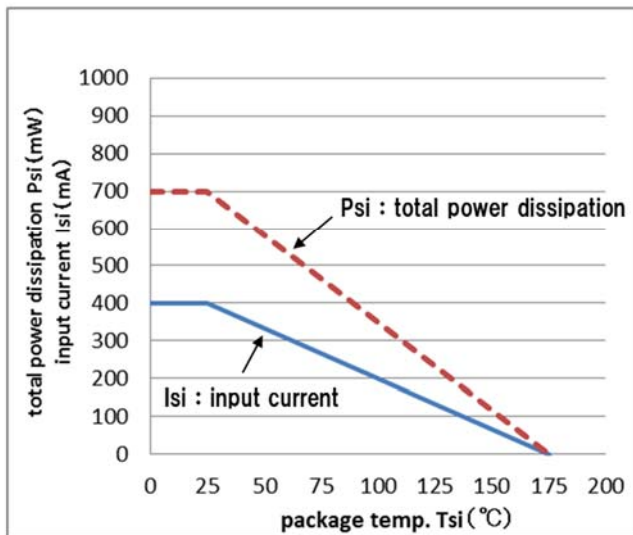
If the pattern is too close to the input block and coupling occurs, a sudden fluctuation in the voltage on the IGBT output side might affect the photocoupler's LED input, leading to malfunction or degradation of characteristics.

(If the pattern needs to be close to the input block, to prevent the LED from lighting during the off state due to the abovementioned coupling, design the input-side circuit so that the bias of the LED is reversed, within the range of the recommended operating conditions, and be sure to thoroughly evaluate operation.)
3. Make sure the rise/fall time of the forward current is 0.5  $\mu\text{s}$  or less.
4. In order to avoid malfunctions, make sure the rise/fall slope of the supply voltage is 3 V/ $\mu\text{s}$  or less.
5. Avoid storage at a high temperature and high humidity.

**SPECIFICATION OF VDE MARKS LICENSE DOCUMENT**

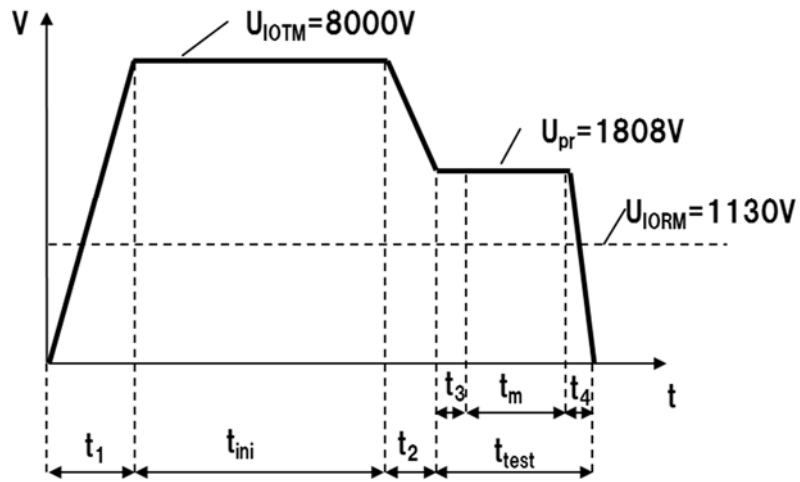
Parameter	Symbol	Spec.	Unit
Climatic test class (IEC 60068-1/DIN EN 60068-1)		40/125/21	
Dielectric strength maximum operating isolation voltage Test voltage (partial discharge test, procedure a for type test and random test) $U_{pr} = 1.6 \times U_{IORM}, P_d < 5 \text{ pC}$	$U_{IORM}$ $U_{pr}$	1 130 1 808	$V_{peak}$ $V_{peak}$
Test voltage (partial discharge test, procedure b for all devices) $U_{pr} = 1.875 \times U_{IORM}, P_d < 5 \text{ pC}$	$U_{pr}$	2 119	$V_{peak}$
Highest permissible overvoltage	$U_{IOTM}$	8 000	$V_{peak}$
Degree of pollution (DIN EN 60664-1 VDE0110 Part 1)		2	
Comparative tracking index (IEC 60112/DIN EN 60112 (VDE 0303 Part 11))	CTI	400	
Material group (DIN EN 60664-1 VDE0110 Part 1)		II	
Storage temperature range	$T_{stg}$	-55 to +150	°C
Operating temperature range	$T_A$	-40 to +125	°C
Isolation resistance, minimum value $V_{IO} = 500 \text{ V dc at } T_A = 25^\circ\text{C}$ $V_{IO} = 500 \text{ V dc at } T_A \text{ MAX. at least } 100^\circ\text{C}$	Ris MIN. Ris MIN.	$10^{12}$ $10^{11}$	$\Omega$ $\Omega$
Safety maximum ratings (maximum permissible in case of fault, see thermal derating curve) Package temperature Current (input current $I_F$ , $P_{si} = 0$ ) Power (output or total power dissipation) Isolation resistance $V_{IO} = 500 \text{ V dc at } T_A = T_{si}$	$T_{si}$ $I_{si}$ $P_{si}$ Ris MIN.	175 400 700 $10^9$	°C mA mW $\Omega$

**Dependence of maximum safety ratings with package temperature**



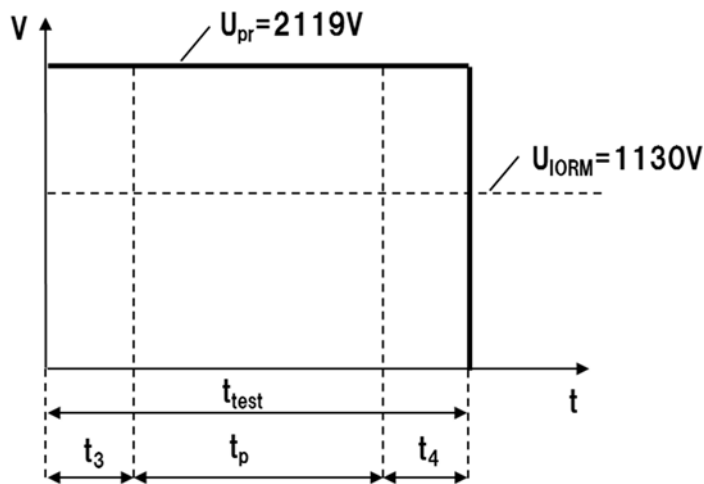


Method A Destructive Test, Type and Sample test



$t_1, t_2 = 1 \text{ to } 10 \text{ sec}$   
 $t_3, t_4 = 1 \text{ sec}$   
 $t_m \text{ (PARTIAL DISCHARGE)} = 10 \text{ sec}$   
 $t_{\text{test}} = 12 \text{ sec}$   
 $t_{\text{ini}} = 60 \text{ sec}$

Method b Non-destructive Test, 100% Production Test



$t_3, t_4 = 0.1 \text{ sec}$   
 $t_p \text{ (PARTIAL DISCHARGE)} = 1.0 \text{ sec}$   
 $t_{\text{test}} = 1.2 \text{ sec}$

<b>Caution</b>	GaAs Products	<p>This product uses gallium arsenide (GaAs). GaAs vapor and powder are hazardous to human health if inhaled or ingested, so please observe the following points.</p> <ul style="list-style-type: none"><li>• Follow related laws and ordinances when disposing of the product. If there are no applicable laws and/or ordinances, dispose of the product as recommended below.<ol style="list-style-type: none"><li>1. Commission a disposal company able to (with a license to) collect, transport and dispose of materials that contain arsenic and other such industrial waste materials.</li><li>2. Exclude the product from general industrial waste and household garbage, and ensure that the product is controlled (as industrial waste subject to special control) up until final disposal.</li></ol></li><li>• Do not burn, destroy, cut, crush, or chemically dissolve the product.</li><li>• Do not lick the product or in any way allow it to enter the mouth.</li></ul>
----------------	---------------	--

## Notice

1. Descriptions of circuits, software and other related information in this document are provided only to illustrate the operation of semiconductor products and application examples. You are fully responsible for the incorporation of these circuits, software, and information in the design of your equipment. Renesas Electronics assumes no responsibility for any losses incurred by you or third parties arising from the use of these circuits, software, or information.
2. Renesas Electronics has used reasonable care in preparing the information included in this document, but Renesas Electronics does not warrant that such information is error free. Renesas Electronics assumes no liability whatsoever for any damages incurred by you resulting from errors in or omissions from the information included herein.
3. Renesas Electronics does not assume any liability for infringement of patents, copyrights, or other intellectual property rights of third parties by or arising from the use of Renesas Electronics products or technical information described in this document. No license, express, implied or otherwise, is granted hereby under any patents, copyrights or other intellectual property rights of Renesas Electronics or others.
4. You should not alter, modify, copy, or otherwise misappropriate any Renesas Electronics product, whether in whole or in part. Renesas Electronics assumes no responsibility for any losses incurred by you or third parties arising from such alteration, modification, copy or otherwise misappropriation of Renesas Electronics product.
5. Renesas Electronics products are classified according to the following two quality grades: "Standard" and "High Quality". The recommended applications for each Renesas Electronics product depends on the product's quality grade, as indicated below.  
"Standard": Computers; office equipment; communications equipment; test and measurement equipment; audio and visual equipment; home electronic appliances; machine tools; personal electronic equipment; and industrial robots etc.  
"High Quality": Transportation equipment (automobiles, trains, ships, etc.); traffic control systems; anti-disaster systems; anti-crime systems; and safety equipment etc.  
Renesas Electronics products are neither intended nor authorized for use in products or systems that may pose a direct threat to human life or bodily injury (artificial life support devices or systems, surgical implantations etc.), or may cause serious property damages (nuclear reactor control systems, military equipment etc.). You must check the quality grade of each Renesas Electronics product before using it in a particular application. You may not use any Renesas Electronics product for any application for which it is not intended. Renesas Electronics shall not be in any way liable for any damages or losses incurred by you or third parties arising from the use of any Renesas Electronics product for which the product is not intended by Renesas Electronics.
6. You should use the Renesas Electronics products described in this document within the range specified by Renesas Electronics, especially with respect to the maximum rating, operating supply voltage range, movement power voltage range, heat radiation characteristics, installation and other product characteristics. Renesas Electronics shall have no liability for malfunctions or damages arising out of the use of Renesas Electronics products beyond such specified ranges.
7. Although Renesas Electronics endeavors to improve the quality and reliability of its products, semiconductor products have specific characteristics such as the occurrence of failure at a certain rate and malfunctions under certain use conditions. Further, Renesas Electronics products are not subject to radiation resistance design. Please be sure to implement safety measures to guard them against the possibility of physical injury, and injury or damage caused by fire in the event of the failure of a Renesas Electronics product, such as safety design for hardware and software including but not limited to redundancy, fire control and malfunction prevention, appropriate treatment for aging degradation or any other appropriate measures. Because the evaluation of microcomputer software alone is very difficult, please evaluate the safety of the final products or systems manufactured by you.
8. Please contact a Renesas Electronics sales office for details as to environmental matters such as the environmental compatibility of each Renesas Electronics product. Please use Renesas Electronics products in compliance with all applicable laws and regulations that regulate the inclusion or use of controlled substances, including without limitation, the EU RoHS Directive. Renesas Electronics assumes no liability for damages or losses occurring as a result of your noncompliance with applicable laws and regulations.
9. Renesas Electronics products and technology may not be used for or incorporated into any products or systems whose manufacture, use, or sale is prohibited under any applicable domestic or foreign laws or regulations. You should not use Renesas Electronics products or technology described in this document for any purpose relating to military applications or use by the military, including but not limited to the development of weapons of mass destruction. When exporting the Renesas Electronics products or technology described in this document, you should comply with the applicable export control laws and regulations and follow the procedures required by such laws and regulations.
10. It is the responsibility of the buyer or distributor of Renesas Electronics products, who distributes, disposes of, or otherwise places the product with a third party, to notify such third party in advance of the contents and conditions set forth in this document, Renesas Electronics assumes no responsibility for any losses incurred by you or third parties as a result of unauthorized use of Renesas Electronics products.
11. This document may not be reproduced or duplicated in any form, in whole or in part, without prior written consent of Renesas Electronics.
12. Please contact a Renesas Electronics sales office if you have any questions regarding the information contained in this document or Renesas Electronics products, or if you have any other inquiries.

(Note 1) "Renesas Electronics" as used in this document means Renesas Electronics Corporation and also includes its majority-owned subsidiaries.

(Note 2) "Renesas Electronics product(s)" means any product developed or manufactured by or for Renesas Electronics.



### SALES OFFICES

Renesas Electronics Corporation

<http://www.renesas.com>

Refer to "<http://www.renesas.com/>" for the latest and detailed information.

#### California Eastern Laboratories, Inc.

4590 Patrick Henry Drive, Santa Clara, California 95054-1817, U.S.A.  
Tel: +1-408-919-2500, Fax: +1-408-988-0279

#### Renesas Electronics Europe Limited

Dukes Meadow, Millboard Road, Bourne End, Buckinghamshire, SL8 5FH, U.K.  
Tel: +44-1628-585-100, Fax: +44-1628-585-900

#### Renesas Electronics Europe GmbH

Arcadiastrasse 10, 40472 Düsseldorf, Germany  
Tel: +49-211-6503-0, Fax: +49-211-6503-1327

#### Renesas Electronics (China) Co., Ltd.

Room 1709, Quantum Plaza, No.27 ZhiChunLu Haidian District, Beijing 100191, P.R.China  
Tel: +86-10-8235-1155, Fax: +86-10-8235-7679

#### Renesas Electronics (Shanghai) Co., Ltd.

Unit 301, Tower A, Central Towers, 555 Langao Road, Putuo District, Shanghai, P. R. China 200333  
Tel: +86-21-2226-0888, Fax: +86-21-2226-0999

#### Renesas Electronics Hong Kong Limited

Unit 1601-1611, 16/F., Tower 2, Grand Century Place, 193 Prince Edward Road West, Mongkok, Kowloon, Hong Kong  
Tel: +852-2265-6688, Fax: +852 2886-9022

#### Renesas Electronics Taiwan Co., Ltd.

13F, No. 363, Fu Shing North Road, Taipei 10543, Taiwan  
Tel: +886-2-8175-9600, Fax: +886 2-8175-9670

#### Renesas Electronics Singapore Pte. Ltd.

80 Bendemeer Road, Unit #06-02, Hyflux Innovation Centre, Singapore 339949  
Tel: +65-6213-0200, Fax: +65-6213-0300

#### Renesas Electronics Malaysia Sdn.Bhd.

Unit 1207, Block B, Menara Amcorp, Amcorp Trade Centre, No. 18, Jln Persiaran Barat, 46050 Petaling Jaya, Selangor Darul Ehsan, Malaysia  
Tel: +60-3-7955-9390, Fax: +60-3-7955-9510

#### Renesas Electronics India Pvt. Ltd.

No.777C, 100 Feet Road, HAL II Stage, Indiranagar, Bangalore, India  
Tel: +91-80-67208700, Fax: +91-80-67208777

#### Renesas Electronics Korea Co., Ltd.

12F., 234 Teheran-ro, Gangnam-Gu, Seoul, 135-080, Korea  
Tel: +82-2-558-3737, Fax: +82-2-558-5141

# Mouser Electronics

Authorized Distributor

Click to View Pricing, Inventory, Delivery & Lifecycle Information:

[Renesas Electronics:](#)

[PS9031-Y-F3-AX](#) [PS9031-Y-V-F3-AX](#)

Компания «Океан Электроники» предлагает заключение долгосрочных отношений при поставках импортных электронных компонентов на взаимовыгодных условиях!

Наши преимущества:

- Поставка оригинальных импортных электронных компонентов напрямую с производств Америки, Европы и Азии, а так же с крупнейших складов мира;
- Широкая линейка поставок активных и пассивных импортных электронных компонентов (более 30 млн. наименований);
- Поставка сложных, дефицитных, либо снятых с производства позиций;
- Оперативные сроки поставки под заказ (от 5 рабочих дней);
- Экспресс доставка в любую точку России;
- Помощь Конструкторского Отдела и консультации квалифицированных инженеров;
- Техническая поддержка проекта, помощь в подборе аналогов, поставка прототипов;
- Поставка электронных компонентов под контролем ВП;
- Система менеджмента качества сертифицирована по Международному стандарту ISO 9001;
- При необходимости вся продукция военного и аэрокосмического назначения проходит испытания и сертификацию в лаборатории (по согласованию с заказчиком);
- Поставка специализированных компонентов военного и аэрокосмического уровня качества (Xilinx, Altera, Analog Devices, Intersil, Interpoint, Microsemi, Actel, Aeroflex, Peregrine, VPT, Syfer, Eurofarad, Texas Instruments, MS Kennedy, Miteq, Cobham, E2V, MA-COM, Hittite, Mini-Circuits, General Dynamics и др.);

Компания «Океан Электроники» является официальным дистрибьютором и эксклюзивным представителем в России одного из крупнейших производителей разъемов военного и аэрокосмического назначения «**JONHON**», а так же официальным дистрибьютором и эксклюзивным представителем в России производителя высокотехнологичных и надежных решений для передачи СВЧ сигналов «**FORSTAR**».



## JONHON

«**JONHON**» (основан в 1970 г.)

Разъемы специального, военного и аэрокосмического назначения:

(Применяются в военной, авиационной, аэрокосмической, морской, железнодорожной, горно- и нефтедобывающей отраслях промышленности)

«**FORSTAR**» (основан в 1998 г.)

ВЧ соединители, коаксиальные кабели,  
кабельные сборки и микроволновые компоненты:

(Применяются в телекоммуникациях гражданского и специального назначения, в средствах связи, РЛС, а так же военной, авиационной и аэрокосмической отраслях промышленности).



Телефон: 8 (812) 309-75-97 (многоканальный)

Факс: 8 (812) 320-03-32

Электронная почта: [ocean@oceanchips.ru](mailto:ocean@oceanchips.ru)

Web: <http://oceanchips.ru/>

Адрес: 198099, г. Санкт-Петербург, ул. Калинина, д. 2, корп. 4, лит. А