

Applications

- Commercial and Military Radar

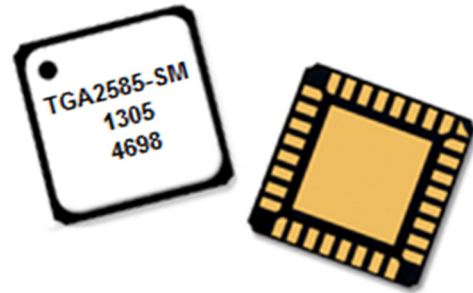

QFN 5x5 mm 32L

Product Features

- Frequency Range: 2.7 - 3.7 GHz
- P_{SAT} : 42.5 dBm
- PAE: > 50 %
- Small Signal Gain: 32 dB
- Return Loss: > 10 dB
- Bias: $V_D = 28$ V (CW or Pulsed), $I_{DQ} = 225$ mA, $V_G = -2.5$ V Typical
- Package Dimensions: 5.0 x 5.0 x 1.45 mm

Functional Block Diagram

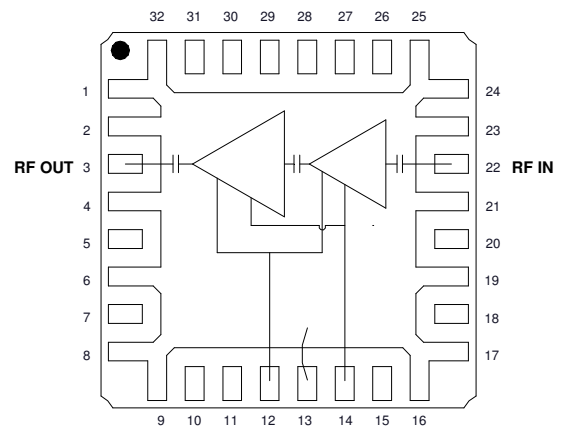

General Description

TriQuint's TGA2585-SM is a packaged MMIC power amplifier which operates from 2.7 to 3.7 GHz. The TGA2585-SM is designed using TriQuint's production 0.25- μ m GaN on SiC process.

The TGA2585-SM typically provides 42.5 dBm of saturated output power, > 50% power-added efficiency, and 32 dB small signal gain. It can operate under both pulse and CW conditions.

The TGA2585-SM is available in a low-cost, surface mount 32 lead 5x5 AIN QFN. It is ideally suited to support both commercial and defense related radar applications.

Both RF ports have integrated DC blocking capacitors and are fully matched to 50 ohms.

Lead-free and RoHS compliant

Evaluation Boards are available upon request.

Pin Configuration

Pad No.	Symbol
1, 3-4, 6, 8-9, 13, 16-17, 19, 21, 23-25, 32	GND
3	RF OUT
5, 7, 10-11, 15, 18, 20, 26-31	NC
12	DRAIN
14	GATE
22	RF IN

Ordering Information

Part	ECCN	Description
TGA2585-SM	EAR99	2.7 - 3.7 GHz, 18 W GaN Power Amplifier

Absolute Maximum Ratings

Parameter	Value
Drain Voltage (V_D)	40 V
Gate Voltage Range (V_G)	-8 to 0 V
Drain Current (I_D)	1530 mA
Gate Current (I_G)	-7 to 11.5 mA
Power Dissipation (P_{DISS}), 85 °C	35 W
Input Power (P_{IN}), CW, 50 Ω , 85 °C	30 dBm
Input Power (P_{IN}), CW, VSWR 10:1, $V_D = 28$ V, 85 °C	23 dBm
Channel Temperature (T_{CH})	275 °C
Mounting Temperature (30 Seconds)	260 °C
Storage Temperature	-55 to 150 °C

Operation of this device outside the parameter ranges given above may cause permanent damage. These are stress ratings only, and functional operation of the device at these conditions is not implied.

Recommended Operating Conditions

Parameter	Value
Drain Voltage (V_D)	28 V
Drain Current (I_{DQ})	225 mA
Drain Current Under RF Drive (I_{D_DRIVE})	See plots p. 7
Gate Voltage (V_G)	-2.5 V (Typ.)
Gate Current Under RF Drive (I_{G_DRIVE})	See plots p. 7

Electrical specifications are measured at specified test conditions. Specifications are not guaranteed over all recommended operating conditions.

Electrical Specifications

Test conditions unless otherwise noted: 25 °C, $V_D = 28$ V, $I_{DQ} = 225$ mA, $V_G = -2.5$ V Typ, Pulsed V_D : PW = 100 us, DC = 10 %

Parameter	Min	Typical	Max	Units
Operational Frequency Range	2.7		3.7	GHz
Small Signal Gain		32		dB
Input Return Loss		> 15		dB
Output Return Loss		> 10		dB
Output Power at Saturation ($P_{IN} = 18$ dBm)		42.5		dBm
Power-Added Efficiency ($P_{IN} = 18$ dBm)		> 50		%
Gain Temperature Coefficient		-0.05		dB/°C
Power Temperature Coefficient		-0.005		dBm/°C

Thermal and Reliability Information

Parameter	Test Conditions	Value	Units
Thermal Resistance (θ_{JC}) ⁽¹⁾	$T_{BASE} = 85^{\circ}\text{C}$, $V_D = 28\text{ V}$ Pulse $PW = 100\text{ us}$, $DC = 10\%$	3.65	$^{\circ}\text{C}/\text{W}$ $^{\circ}\text{C}$
Channel Temperature (T_{CH}) (Under RF drive)	At Freq = 3 GHz, $P_{IN} = 18\text{ dBm}$: $I_{DQ} = 225\text{ mA}$, $I_{D_Drive} = 1330\text{ mA}$	153	$^{\circ}\text{C}$
Median Lifetime (T_M)	$P_{OUT} = 42.7\text{ dBm}$ $P_{DISS} = 18.6\text{ W}$	1.26E+9	Hrs

Notes:

1. Thermal resistance measured to back of package.

Test Conditions: $V_D = 40\text{ V}$; Failure Criteria = 10% reduction in I_{D_MAX}

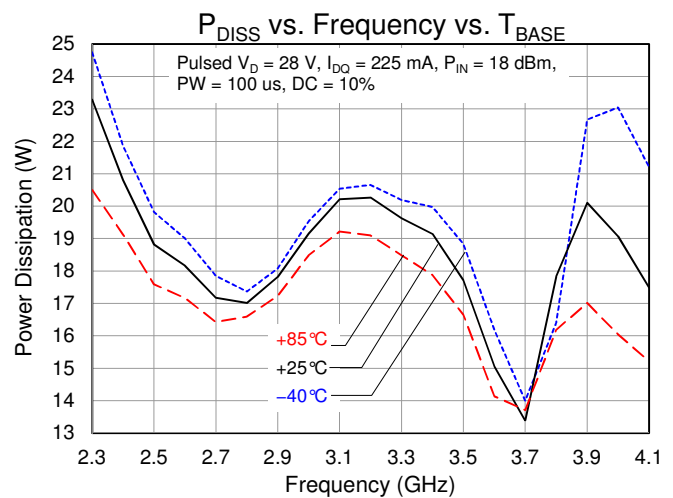
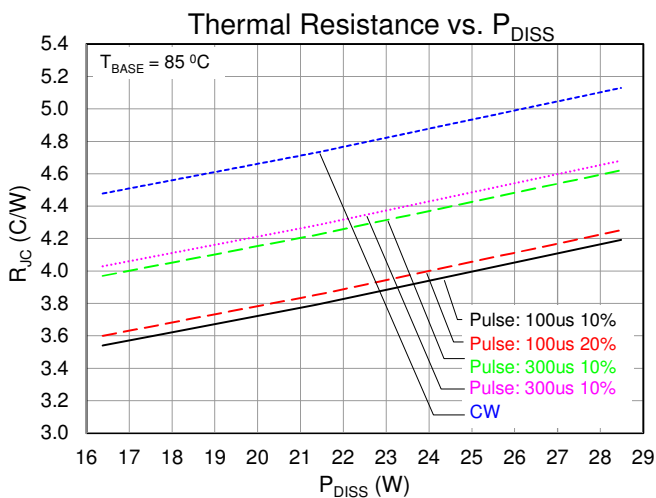
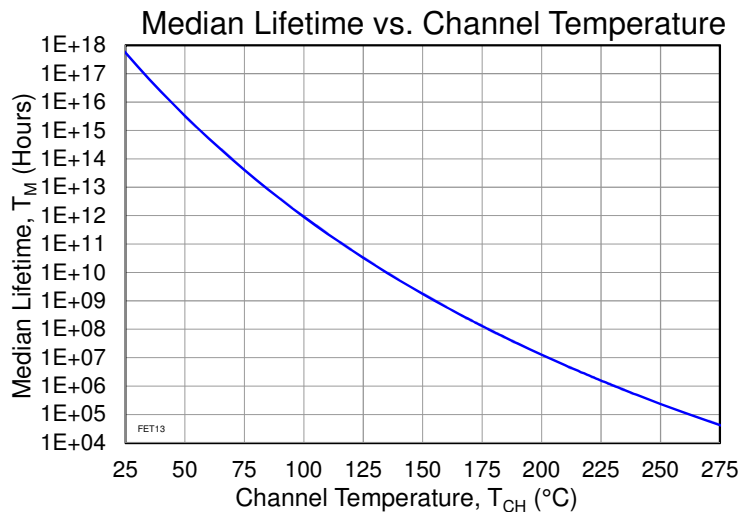

Typical Performance: Small Signal

Condition: CW

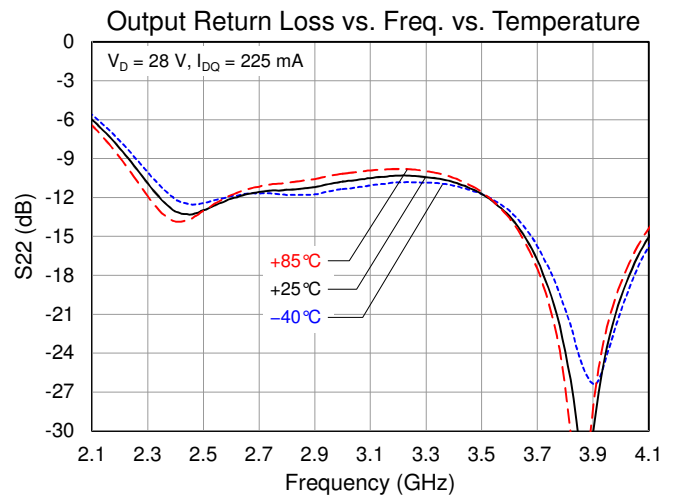
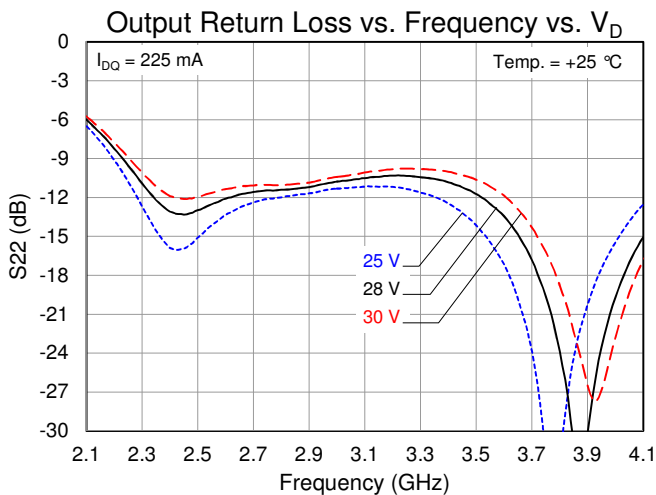
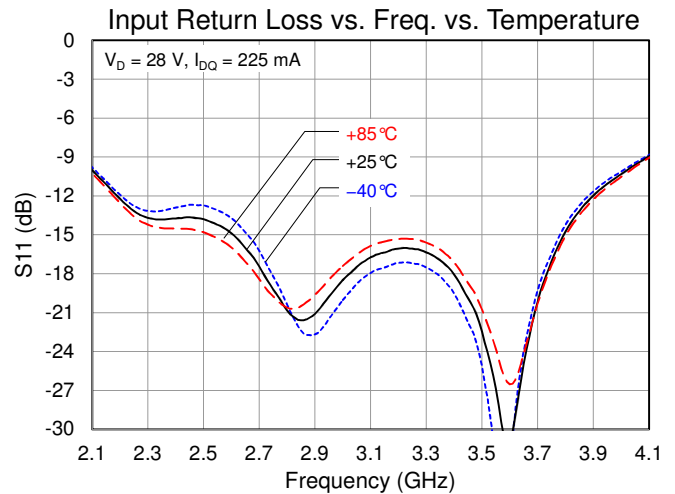
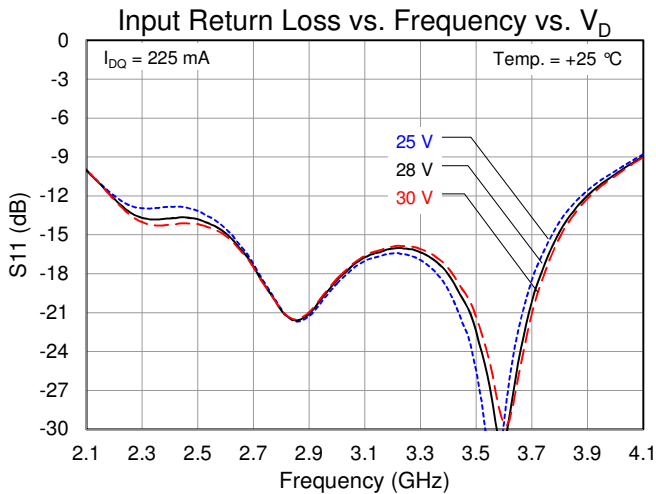
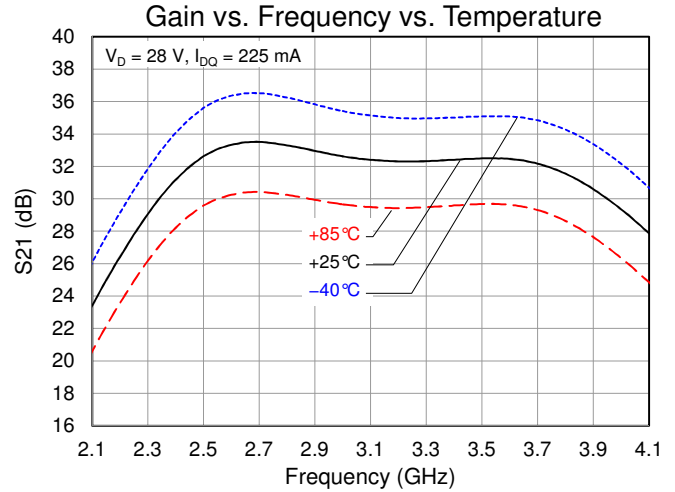
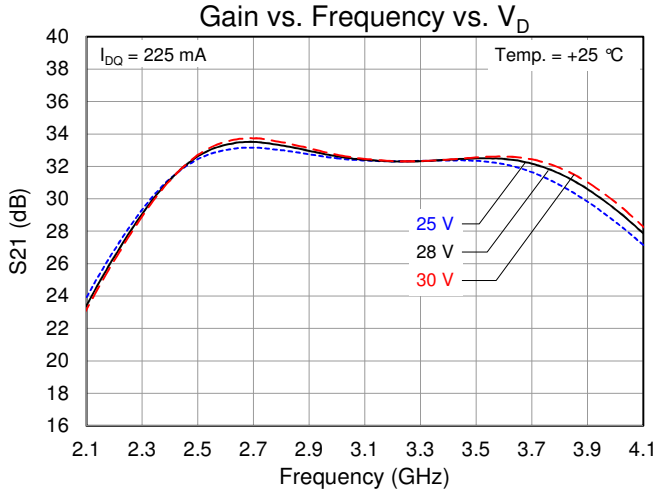

Typical Performance: Large Signal

Condition: Pulsed V_D , Pulse Width = 100 us, Duty Cycle = 10%

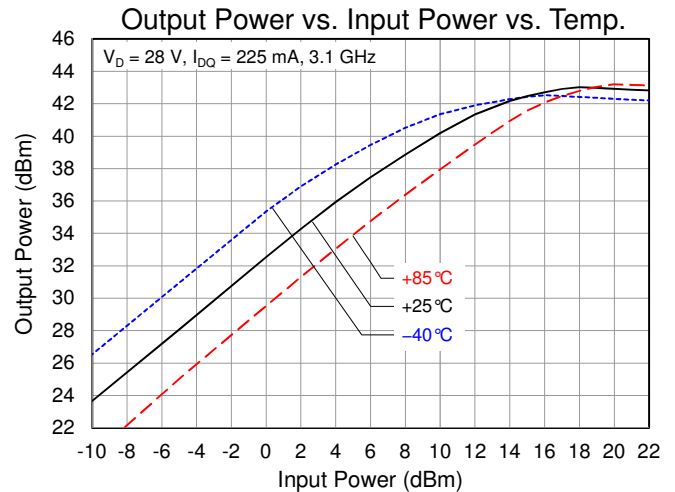
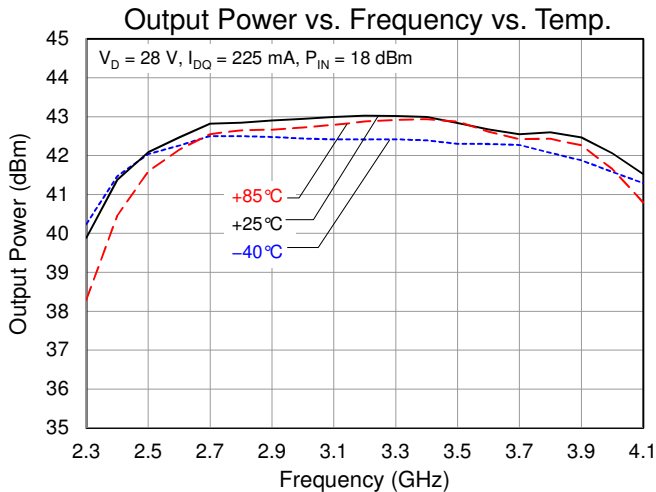
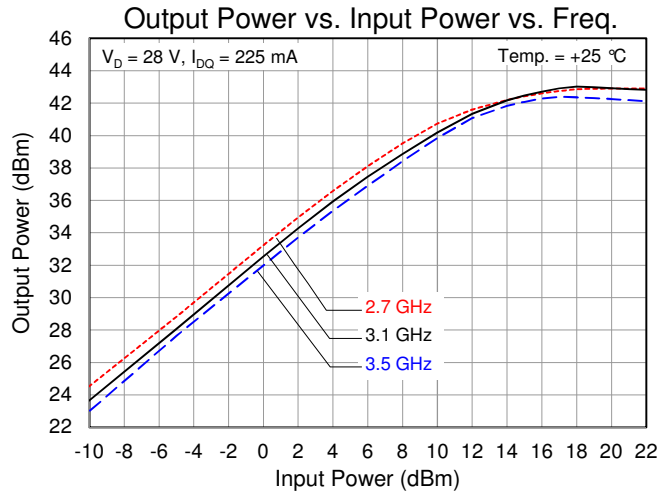
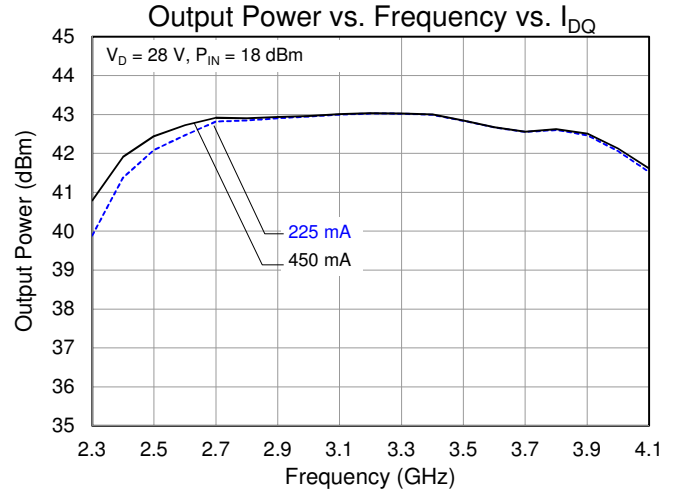
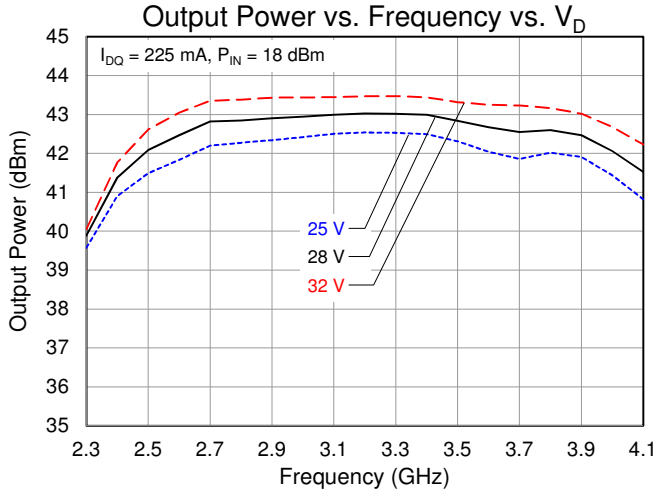

Typical Performance: Large Signal

Condition: Pulsed V_D , Pulse Width = 100 us, Duty Cycle = 10%

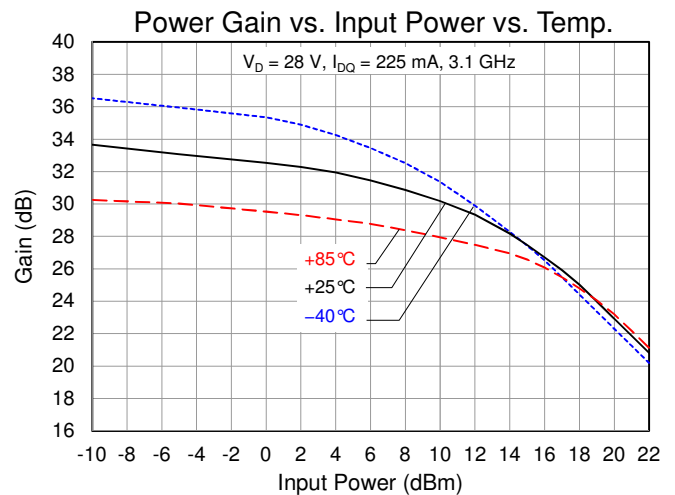
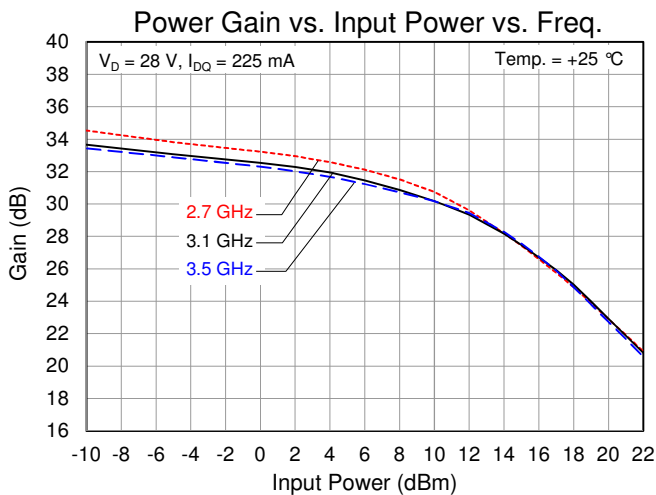
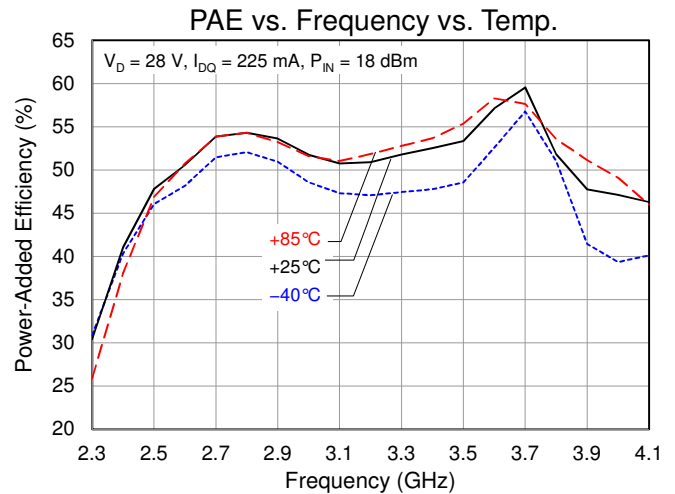
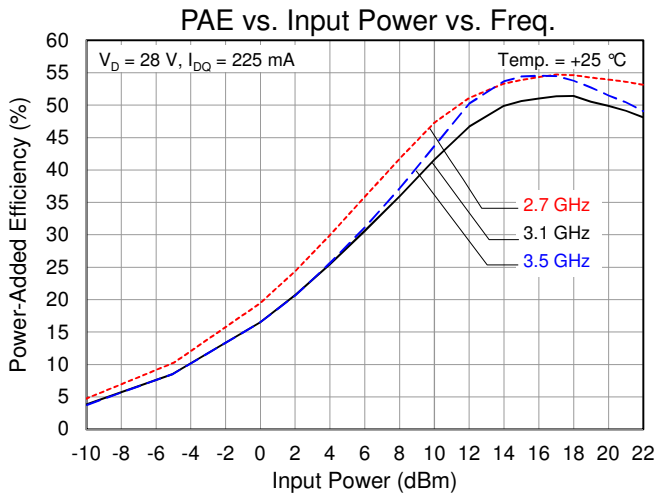
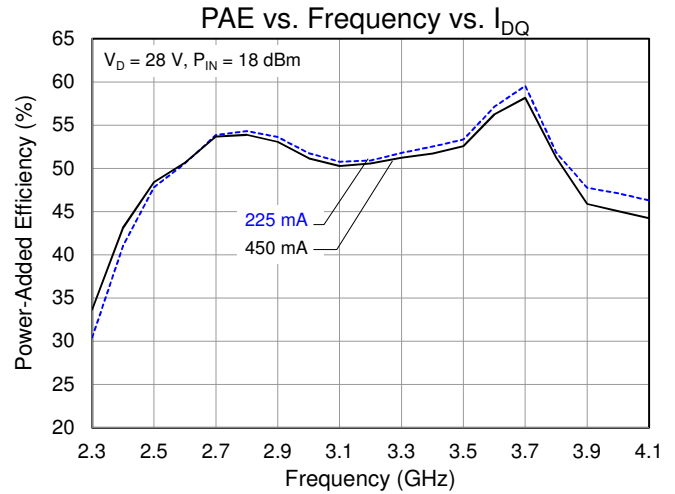
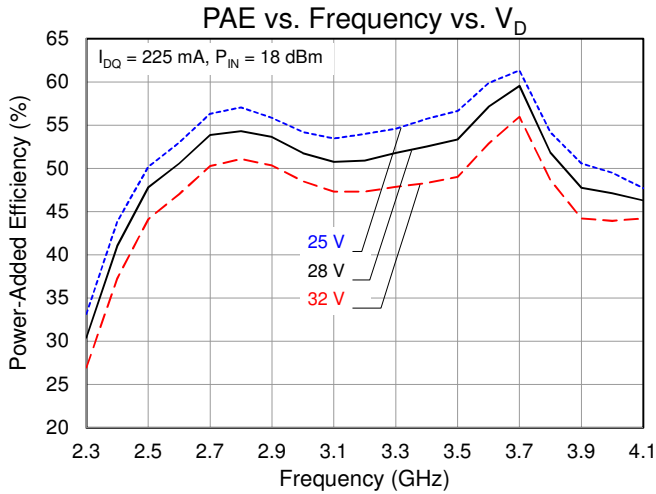

Typical Performance: Large Signal

Condition: Pulsed V_D , Pulse Width = 100 us, Duty Cycle = 10%

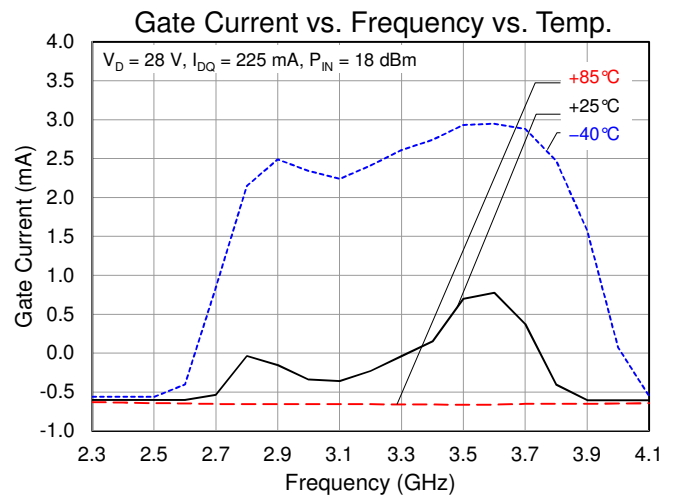
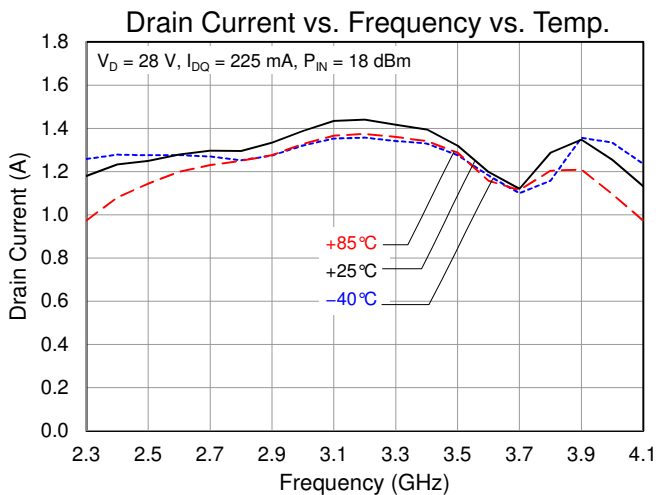
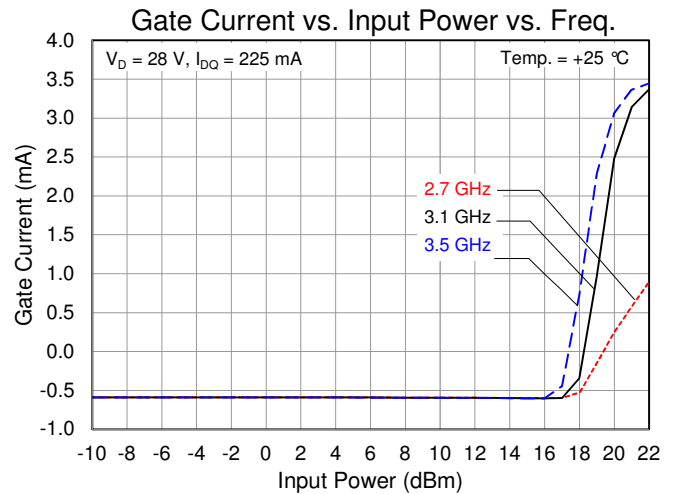
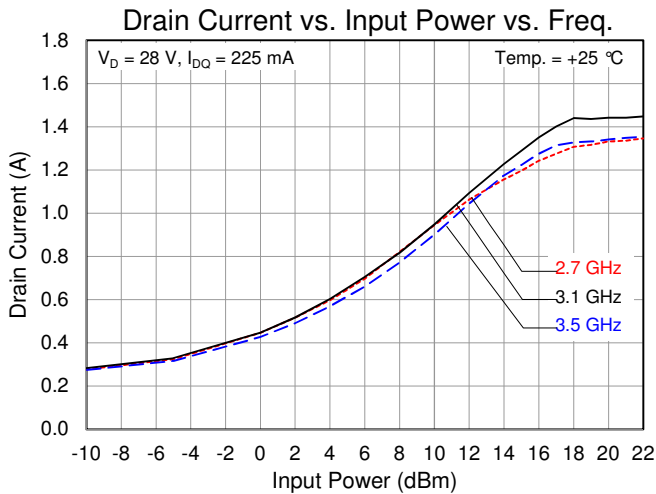
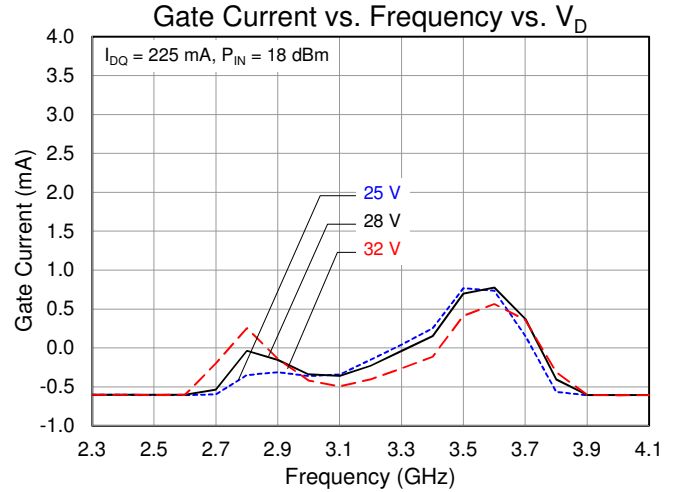
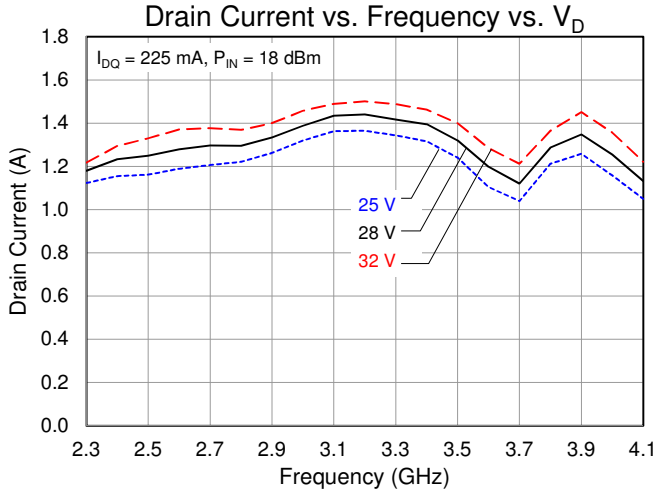

Applications Information

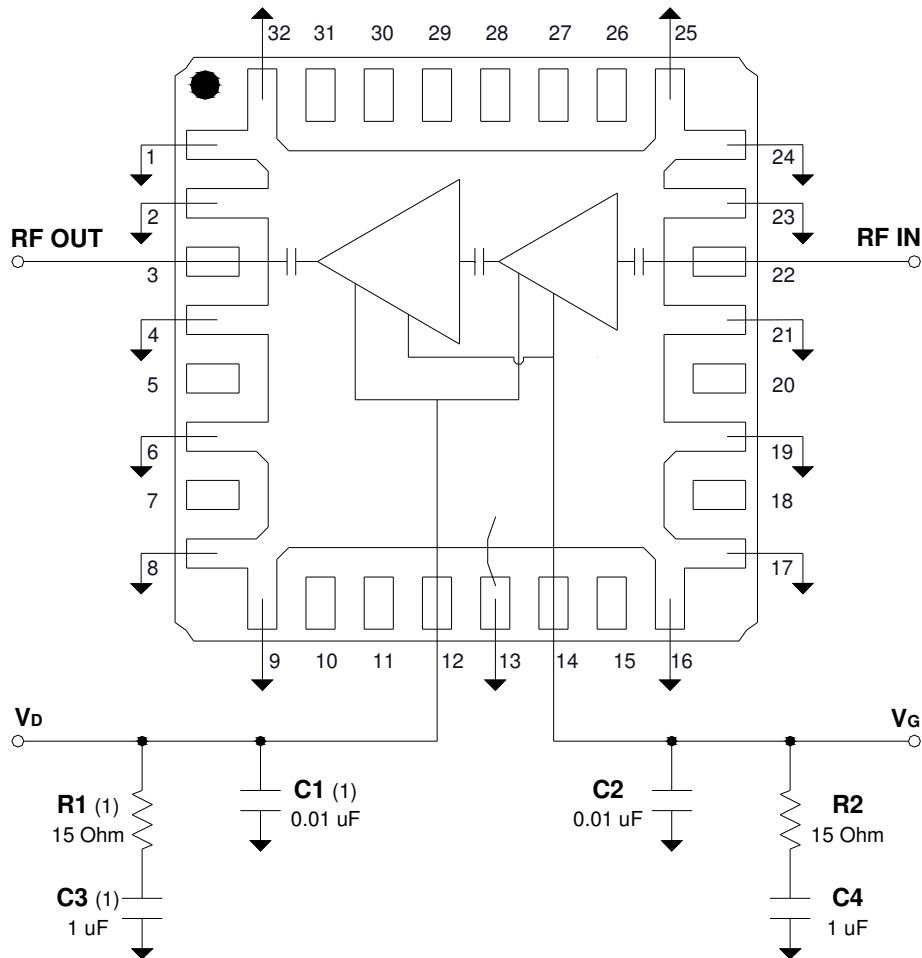

Notes:

1. Remove if pulsing on drain

Bias-up Procedure

1. Set I_D limit to 1.53 A, I_G limit to 8 mA
2. Apply -5 V to V_G
3. Apply $+28$ V to V_D ; ensure I_{DQ} is approx. 0 mA
4. Adjust V_G until $I_{DQ} = 225$ mA ($V_G \sim -2.5$ V Typ.).
5. Turn on RF supply

Bias-down Procedure

1. Turn off RF supply
2. Reduce V_G to -5 V; ensure I_{DQ} is approx. 0 mA
3. Set V_D to 0 V
4. Turn off V_D supply
5. Turn off V_G supply

Pin Layout

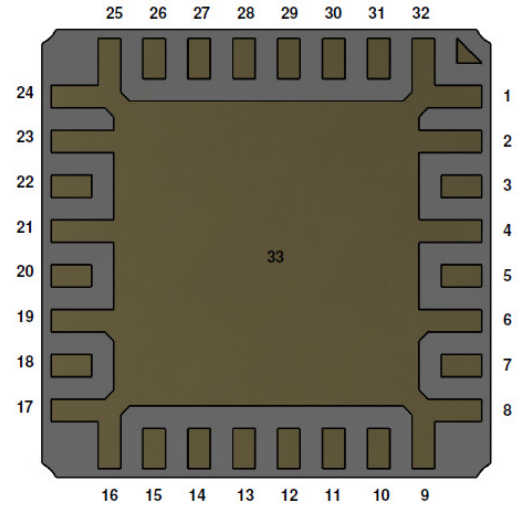
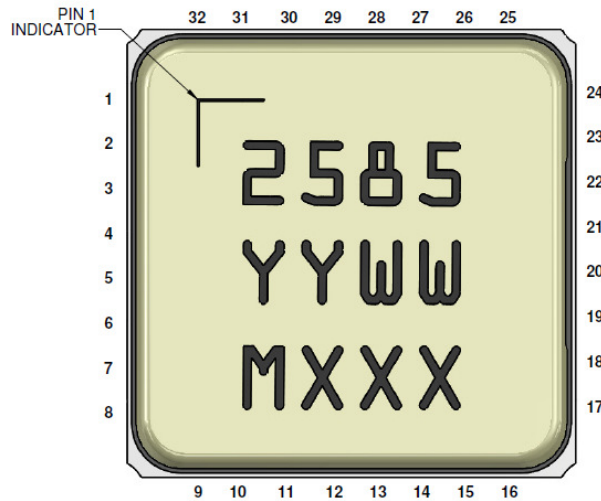

Pin Description

Pin No.	Symbol	Description
1, 3-4, 6, 8-9, 13, 16-17, 19, 21, 23-25, 32	GND	Connected to ground paddle (pin 33); must be grounded on PCB
3	RF OUT	Output; matched to 50 Ω ; DC blocked
5, 7, 10-11, 15, 18, 20, 26-31	NC	No connection
12	DRAIN	Drain voltage; bias network is required; see recommended Application Information on page 8
14	GATE	Gate voltage; bias network is required; see recommended Application Information on page 8
22	RF IN	Input; matched to 50 Ω ; DC blocked
33	GND	Ground Paddle. Multiple vias should be employed to minimize inductance and thermal resistance.

Evaluation Board

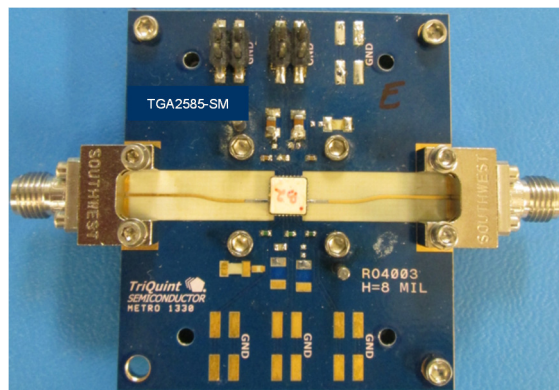
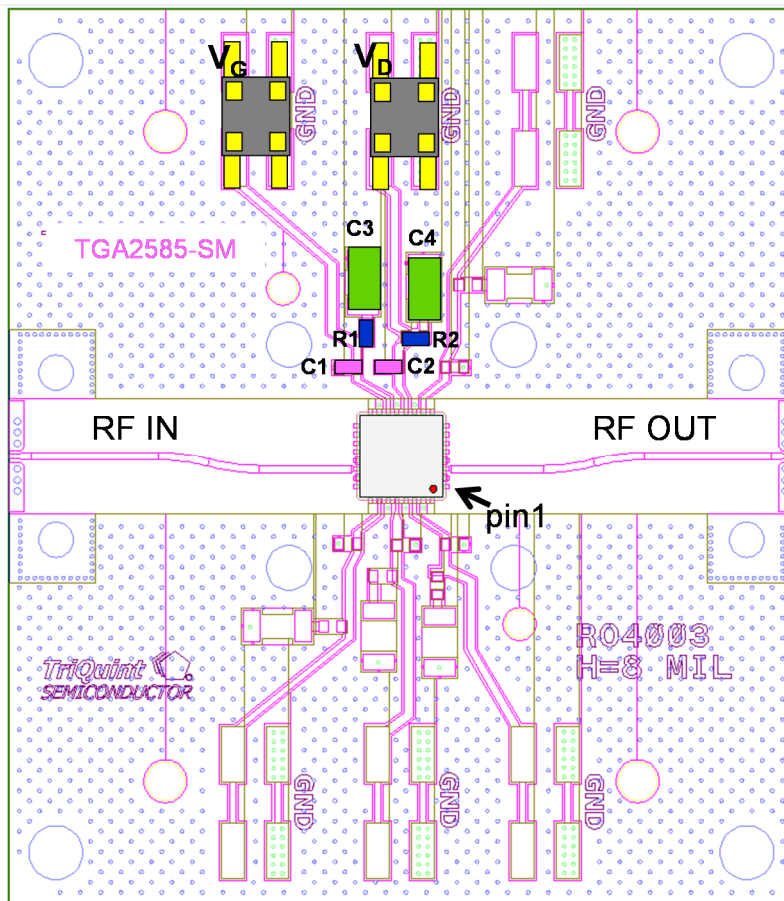

Bill of Material

Reference Des.	Value	Description	Manuf.	Part Number
C1, C2	0.01 μ F	Cap, 0402, 50 V, 10%, X7R	Various	
C3, C4	1 μ F	Cap, 0805, 50 V, 10%, X7R	Various	
R1, R2	15 Ohm	Res, 0402, 5%	Various	

Mechanical Information

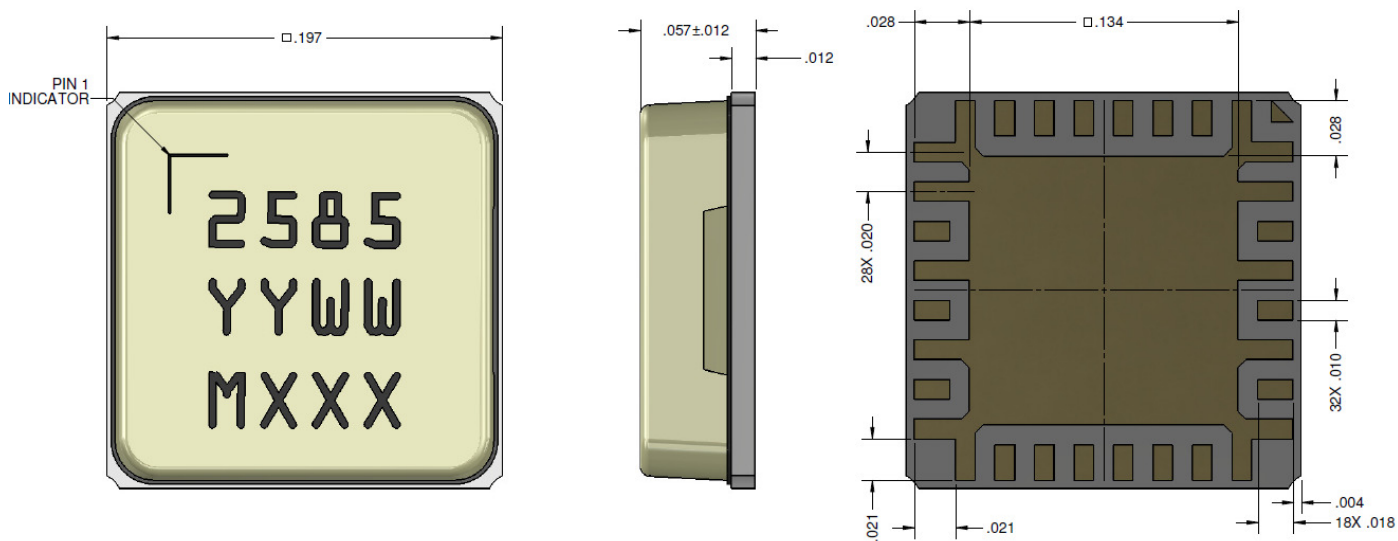

Units: inches

Tolerances: unless specified

x.xx = ± 0.01

x.xxx = ± 0.005

Materials:

Base: Ceramic

Lid: Plastic

All metalized features are gold plated

Part is epoxy sealed

Marking:

2583: Part number

YY: Part Assembly year

WW: Part Assembly week

MXXX: Batch ID

Recommended Soldering Temperature Profile

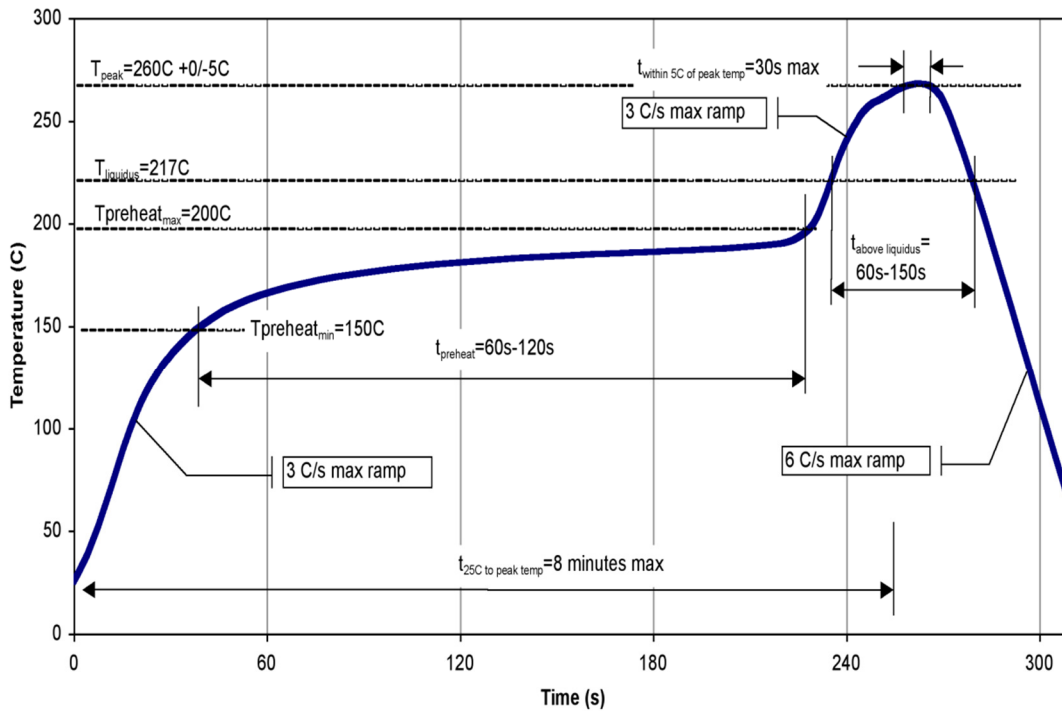

Product Compliance Information

ESD Sensitivity Ratings



Caution! ESD-Sensitive Device

ESD Rating: TBD
Value: TBD
Test: Human Body Model (HBM)
Standard: JEDEC Standard JESD22-A114

MSL Rating

Level TBD at TBD °C convection reflow
The part is rated Moisture Sensitivity Level TBD at TBD °C
per JEDEC standard IPC/JEDEC J-STD-020.

ECCN

US Department of Commerce: EAR99

Solderability

Compatible with the latest version of J-STD-020, Lead-free solder, 260 °C

RoHS Compliance

This part is compliant with EU 2002/95/EC RoHS directive (Restrictions on the Use of Certain Hazardous Substances in Electrical and Electronic Equipment).

This product also has the following attributes:

- Lead Free
- Halogen Free (Chlorine, Bromine)
- Antimony Free
- TBBP-A (C₁₅H₁₂Br₄O₂) Free
- PFOS Free
- SVHC Free

Contact Information

For the latest specifications, additional product information, worldwide sales and distribution locations, and information about TriQuint:

Web: www.triquint.com
Email: info-sales@triquint.com

Tel: +1.972.994.8465
Fax: +1.972.994.8504

For technical questions and application information: Email: info-products@triquint.com

Important Notice

The information contained herein is believed to be reliable. TriQuint makes no warranties regarding the information contained herein. TriQuint assumes no responsibility or liability whatsoever for any of the information contained herein. TriQuint assumes no responsibility or liability whatsoever for the use of the information contained herein. The information contained herein is provided "AS IS, WHERE IS" and with all faults, and the entire risk associated with such information is entirely with the user. All information contained herein is subject to change without notice. Customers should obtain and verify the latest relevant information before placing orders for TriQuint products. The information contained herein or any use of such information does not grant, explicitly or implicitly, to any party any patent rights, licenses, or any other intellectual property rights, whether with regard to such information itself or anything described by such information.

TriQuint products are not warranted or authorized for use as critical components in medical, life-saving, or life-sustaining applications, or other applications where a failure would reasonably be expected to cause severe personal injury or death.

Компания «Океан Электроники» предлагает заключение долгосрочных отношений при поставках импортных электронных компонентов на взаимовыгодных условиях!

Наши преимущества:

- Поставка оригинальных импортных электронных компонентов напрямую с производств Америки, Европы и Азии, а так же с крупнейших складов мира;
- Широкая линейка поставок активных и пассивных импортных электронных компонентов (более 30 млн. наименований);
- Поставка сложных, дефицитных, либо снятых с производства позиций;
- Оперативные сроки поставки под заказ (от 5 рабочих дней);
- Экспресс доставка в любую точку России;
- Помощь Конструкторского Отдела и консультации квалифицированных инженеров;
- Техническая поддержка проекта, помощь в подборе аналогов, поставка прототипов;
- Поставка электронных компонентов под контролем ВП;
- Система менеджмента качества сертифицирована по Международному стандарту ISO 9001;
- При необходимости вся продукция военного и аэрокосмического назначения проходит испытания и сертификацию в лаборатории (по согласованию с заказчиком);
- Поставка специализированных компонентов военного и аэрокосмического уровня качества (Xilinx, Altera, Analog Devices, Intersil, Interpoint, Microsemi, Actel, Aeroflex, Peregrine, VPT, Syfer, Eurofarad, Texas Instruments, MS Kennedy, Miteq, Cobham, E2V, MA-COM, Hittite, Mini-Circuits, General Dynamics и др.);

Компания «Океан Электроники» является официальным дистрибьютором и эксклюзивным представителем в России одного из крупнейших производителей разъемов военного и аэрокосмического назначения «JONHON», а так же официальным дистрибьютором и эксклюзивным представителем в России производителя высокотехнологичных и надежных решений для передачи СВЧ сигналов «FORSTAR».



JONHON

«JONHON» (основан в 1970 г.)

Разъемы специального, военного и аэрокосмического назначения:

(Применяются в военной, авиационной, аэрокосмической, морской, железнодорожной, горно- и нефтедобывающей отраслях промышленности)

«FORSTAR» (основан в 1998 г.)

ВЧ соединители, коаксиальные кабели,
кабельные сборки и микроволновые компоненты:

(Применяются в телекоммуникациях гражданского и специального назначения, в средствах связи, РЛС, а так же военной, авиационной и аэрокосмической отраслях промышленности).



Телефон: 8 (812) 309-75-97 (многоканальный)

Факс: 8 (812) 320-03-32

Электронная почта: ocean@oceanchips.ru

Web: <http://oceanchips.ru/>

Адрес: 198099, г. Санкт-Петербург, ул. Калинина, д. 2, корп. 4, лит. А