

6A Analog FemtoDLynxII™: Non-Isolated DC-DC Power Modules

4.5Vdc –14.4Vdc input; 0.6Vdc to 5.5Vdc output; 6A Output Current



RoHS Compliant

Applications

- Distributed power architectures
- Intermediate bus voltage applications
- Telecommunications equipment
- Servers and storage applications
- Networking equipment
- Industrial equipment

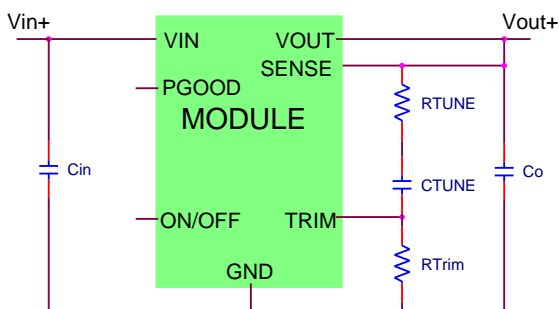

Description

The 6A Analog FemtoDLynxII™ power modules are non-isolated dc-dc converters that can deliver up to 6A of output current. These modules operate over a wide range of input voltage ($V_{IN} = 4.5\text{Vdc}-14.4\text{Vdc}$) and provide a precisely regulated output voltage from 0.6Vdc to 5.5Vdc, programmable via an external resistor. Features include remote On/Off, adjustable output voltage, over current and over temperature protection. The Tunable Loop™ feature allows the user to optimize the dynamic response of the converter to match the load with reduced amount of output capacitance leading to savings on cost and PWB area.

* UL is a registered trademark of Underwriters Laboratories, Inc.

† CSA is a registered trademark of Canadian Standards Association.

‡ VDE is a trademark of Verband Deutscher Elektrotechniker e.V.

** ISO is a registered trademark of the International Organization of Standards

Features

- Compliant to RoHS Directive 2011/65/EU and amended Directive (EU) 2015/863
- Compliant to REACH Directive (EC) No 1907/2006
- Compatible in a Pb-free or SnPb reflow environment
- Compliant to IPC-9592 (November 2012), Category 2, Class I
- Wide Input voltage range (4.5Vdc-14.4Vdc).
- Output voltage programmable from 0.6Vdc to 5.5Vdc via external resistor
- Tunable Loop™ to optimize dynamic output voltage response
- Power Good signal
- Fixed switching frequency
- Output overcurrent protection (non-latching)
- Overtemperature protection
- Remote On/Off
- Ability to sink and source current
- Cost efficient open frame design
- Small size: 6.76 mm x 9 mm x 7.2 mm
(0.27 in x 0.35 in x 0.28 in)
- Wide operating temperature range [-40°C to 85°C]
- ANSI/UL 60950-1 2nd Ed. Revised October 14, 2014, CSA† C22.2 No. 60950-1-07, Second Ed. + A2:2014 (MOD) Recognized, DIN EN 60950-1:2006 + A11:2009 + A1:2010 + A12:2011, + A2:2013 (VDE‡ 0805-1) Licensed
- ISO** 9001 and ISO 14001 certified manufacturing facilities

6A Analog FemtoDLynxII™: Non-Isolated DC-DC Power Modules

4.5Vdc –14.4Vdc input; 0.6Vdc to 5.5Vdc output; 6A Output Current

Absolute Maximum Ratings

Stresses in excess of the absolute maximum ratings can cause permanent damage to the device. These are absolute stress ratings only, functional operation of the device is not implied at these or any other conditions in excess of those given in the operations sections of the data sheet. Exposure to absolute maximum ratings for extended periods can adversely affect the device reliability.

Parameter	Device	Symbol	Min	Max	Unit
Input Voltage Continuous	All	V_{IN}	-0.3	15	Vdc
Operating Ambient Temperature (see Thermal Considerations section)	All	T_A	-40	85	°C
Storage Temperature	All	T_{stg}	-55	125	°C

Electrical Specifications

Unless otherwise indicated, specifications apply over all operating input voltage, resistive load, and temperature conditions.

Parameter	Device	Symbol	Min	Typ	Max	Unit
Operating Input Voltage	All	V_{IN}	4.5	—	14.4	Vdc
Maximum Input Current ($V_{IN}=3V$ to $14V$, $I_O=I_{O,max}$)	All	$I_{IN,max}$			5.7	Adc
Input No Load Current ($V_{IN} = 12.0Vdc$, $I_O = 0$, module enabled)	$V_{O,set} = 0.6 Vdc$	$I_{IN,No load}$		17		mA
	$V_{O,set} = 5Vdc$	$I_{IN,No load}$		63		mA
Input Stand-by Current ($V_{IN} = 12.0Vdc$, module disabled)	All	$I_{IN,stand-by}$		20		mA
Inrush Transient	All	I^2t			1	A ² s
Input Reflected Ripple Current, peak-to-peak (5Hz to 20MHz, 1 μ H source impedance; $V_{IN}=0$ to 14V, $I_O=I_{O,max}$; See Test Configurations)	All			23		mAp-p
Input Ripple Rejection (120Hz)	All			-60		dB

6A Analog FemtoDLynxII™: Non-Isolated DC-DC Power Modules

4.5Vdc –14.4Vdc input; 0.6Vdc to 5.5Vdc output; 6A Output Current

Electrical Specifications (continued)

Parameter	Device	Symbol	Min	Typ	Max	Unit
Output Voltage Set-point (with 0.1% tolerance for external resistor used to set output voltage)	All	$V_{O, set}$	-1.0		+1.0	% $V_{O, set}$
Adjustment Range (selected by an external resistor) (Some output voltages may not be possible depending on the input voltage – see Feature Descriptions Section)	All	V_o	0.6		5.5	Vdc
Remote Sense Range	All				0.3	Vdc
Output Regulation (for $V_o \geq 2.5$ Vdc)						
Line ($V_{IN}=V_{IN, min}$ to $V_{IN, max}$)	All			—	+0.4	% $V_{O, set}$
Load ($I_o=I_{o, min}$ to $I_{o, max}$)	All			—	20	mV
Output Regulation (for $V_o < 2.5$ Vdc)						
Line ($V_{IN}=V_{IN, min}$ to $V_{IN, max}$)	All			—	5	mV
Load ($I_o=I_{o, min}$ to $I_{o, max}$)	All			—	10	mV
Output Ripple and Noise on nominal output ($V_{IN}=V_{IN, nom}$ and $I_o=I_{o, min}$ to $I_{o, max}$, $V_{OUT}=1.2$ V, $T=25^\circ$ C $C_o = 0.1\mu$ F // 22 μ F ceramic capacitors)						
Peak-to-Peak (5Hz to full bandwidth)	All		—	35		mV _{pk-pk}
RMS (5Hz to full bandwidth)	All			3.5		mV _{rms}
External Capacitance ¹						
Without the Tunable Loop™						
ESR ≥ 1 m Ω	All	$C_{O, max}$	44	—	88	μ F
With the Tunable Loop™						
ESR ≥ 0.15 m Ω	All	$C_{O, max}$	44	—	1000	μ F
ESR ≥ 9 m Ω	All	$C_{O, max}$	44	—	3000	μ F
Output Current (in either sink or source mode)	All	I_o	0		6	A _{dc}
Output Current Limit Inception (Hiccup Mode) (current limit does not operate in sink mode)	All	$I_{o, lim}$		150		% $I_{o, max}$
Output Short-Circuit Current ($V_o \leq 250$ mV) (Hiccup Mode)	All	$I_{o, s/c}$		0.75		A _{rms}
Efficiency	$V_{O, set} = 0.6$ Vdc	η		74		%
$V_{IN} = 12$ Vdc, $T_A = 25^\circ$ C	$V_{O, set} = 1.2$ Vdc	η		83.5		%
$I_o = I_{o, max}$, $V_o = V_{O, set}$	$V_{O, set} = 1.8$ Vdc	η		87.7		%
	$V_{O, set} = 2.5$ Vdc	η		90.3		%
	$V_{O, set} = 3.3$ Vdc	η		91.7		%
	$V_{O, set} = 5.0$ Vdc	η		93.5		%
Switching Frequency	All	f_{sw}	—	600	—	kHz

¹ External capacitors may require using the new Tunable Loop™ feature to ensure that the module is stable as well as getting the best transient response. See the Tunable Loop™ section for details.

6A Analog FemtoDLynxII™: Non-Isolated DC-DC Power Modules

4.5Vdc –14.4Vdc input; 0.6Vdc to 5.5Vdc output; 6A Output Current

General Specifications

Parameter	Device	Min	Typ	Max	Unit
Calculated MTBF ($I_o=0.8I_{o,max}$, $T_A=40^\circ\text{C}$) Telecordia Issue 2 Method 1 Case 3	All		50,351,099		Hours
Weight		—	0.9 (0.032)	—	g (oz.)

Feature Specifications

Unless otherwise indicated, specifications apply over all operating input voltage, resistive load, and temperature conditions. See Feature Descriptions for additional information.

Parameter	Device	Symbol	Min	Typ	Max	Unit
Device Code with no suffix – Negative Logic (See Ordering Information) (On/OFF pin is open collector/drain logic input with external pull-up resistor; signal referenced to GND)						
Logic High (Module OFF)						
Input High Current	All	I_{IH}	—	—	1	mA
Input High Voltage	All	V_{IH}	3.0	—	$V_{IN,max}$	Vdc
Logic Low (Module ON)						
Input low Current	All	I_{IL}	—	—	10	μA
Input Low Voltage	All	V_{IL}	-0.2	—	0.4	Vdc
Turn-On Delay and Rise Times ($V_{IN}=V_{IN,nom}$, $I_o=I_{o,max}$, V_o to within $\pm 1\%$ of steady state)						
Case 1: On/Off input is enabled and then input power is applied (delay from instant at which $V_{IN} = V_{IN,min}$ until $V_o = 10\%$ of $V_{o,set}$)	All	Tdelay	—	6	—	msec
Case 2: Input power is applied for at least one second and then the On/Off input is enabled (delay from instant at which $V_{on/Off}$ is enabled until $V_o = 10\%$ of $V_{o,set}$)	All	Tdelay	—	5	—	msec
Output voltage Rise time (time for V_o to rise from 10% of $V_{o,set}$ to 90% of $V_{o,set}$)	All	Trise	—	2	—	msec
Output voltage overshoot ($T_A = 25^\circ\text{C}$ $V_{IN} = V_{IN,min}$ to $V_{IN,max}$, $I_o = I_{o,min}$ to $I_{o,max}$) With or without maximum external capacitance					3.0	% $V_{o,set}$
Over Temperature Protection (See Thermal Considerations section)	All	T_{ref}		150		$^\circ\text{C}$
Input Undervoltage Lockout						
Turn-on Threshold	All				4.2	Vdc
Turn-off Threshold	All			2.4		Vdc
Hysteresis	All			0.2		Vdc

6A Analog FemtoDLynxII™: Non-Isolated DC-DC Power Modules

4.5Vdc –14.4Vdc input; 0.6Vdc to 5.5Vdc output; 6A Output Current

Parameter	Device	Symbol	Min	Typ	Max	Unit
PGOOD (Power Good)						
Signal Interface Open Drain, $V_{supply} \leq 5VDC$						
Overvoltage threshold for PGOOD				112.5		% $V_{O,set}$
Undervoltage threshold for PGOOD				87.5		% $V_{O,set}$
Pulldown resistance of PGOOD pin	All			30		Ω
Sink current capability into PGOOD pin	All				5	mA

6A Analog FemtoDLynxII™: Non-Isolated DC-DC Power Modules

4.5Vdc –14.4Vdc input; 0.6Vdc to 5.5Vdc output; 6A Output Current

Characteristic Curves

The following figures provide typical characteristics for the 6A Analog FemtoDLynxII™ at 0.6V_o and 25°C.

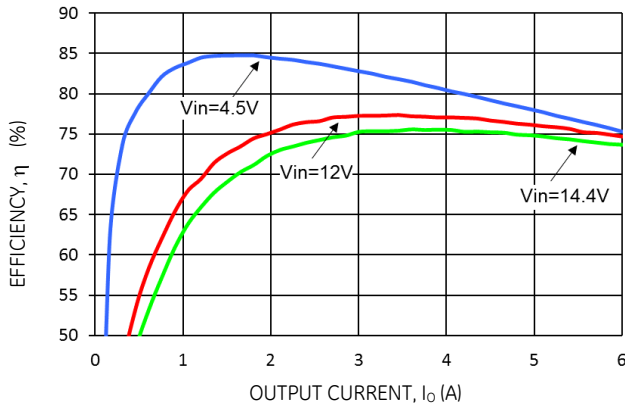

Figure 1. Converter Efficiency versus Output Current.

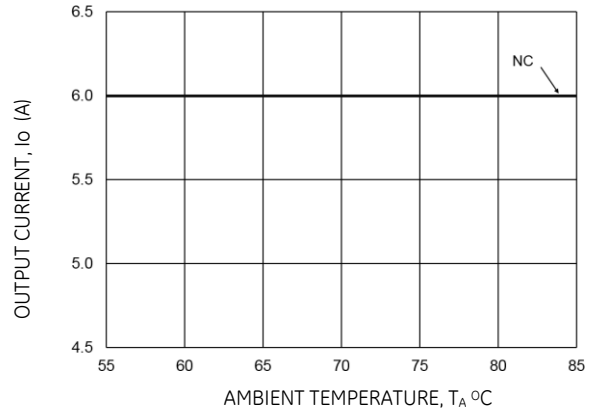

Figure 2. Derating Output Current versus Ambient Temperature and Airflow.

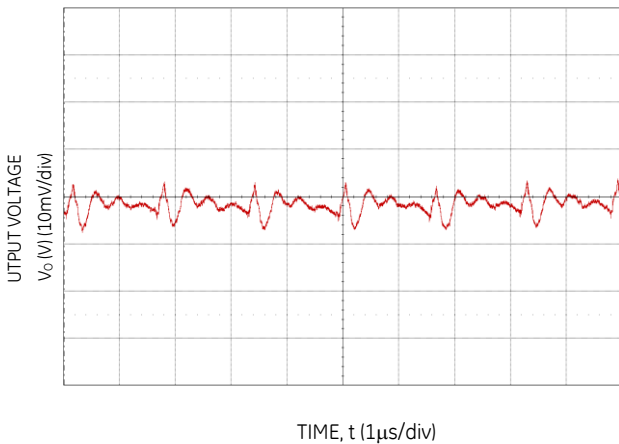

Figure 3. Typical output ripple and noise (C_o=88µF ceramic, V_{IN} = 12V, I_o = I_{o,max}).

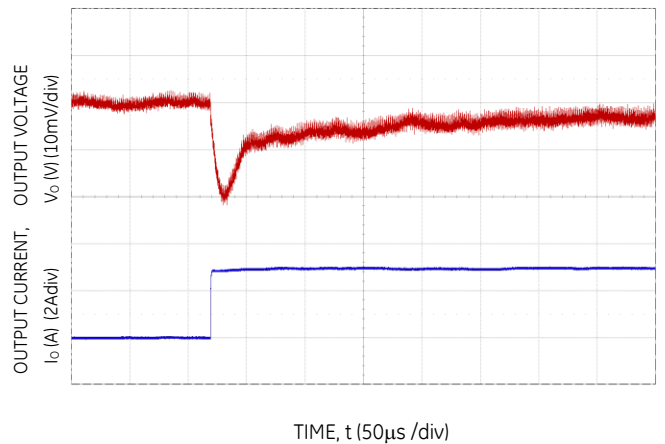

Figure 4. Transient Response to Dynamic Load Change from 50% to 100% at 12V_{in}, C_{out}-2x330µF, 6x100µF, Ctune-10nF, R_{tune}-500

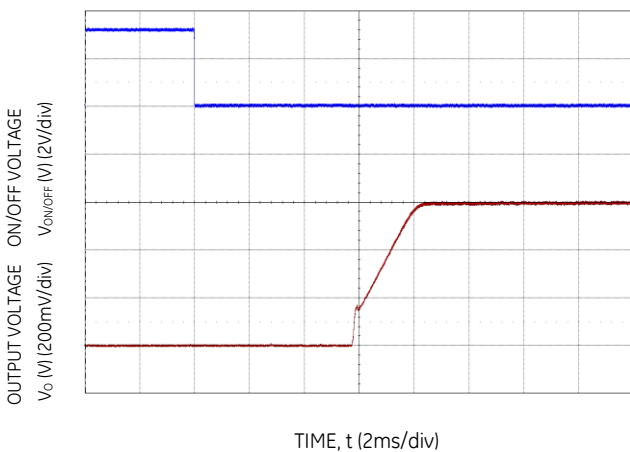

Figure 5. Typical Start-up Using On/Off Voltage (I_o = I_{o,max}).

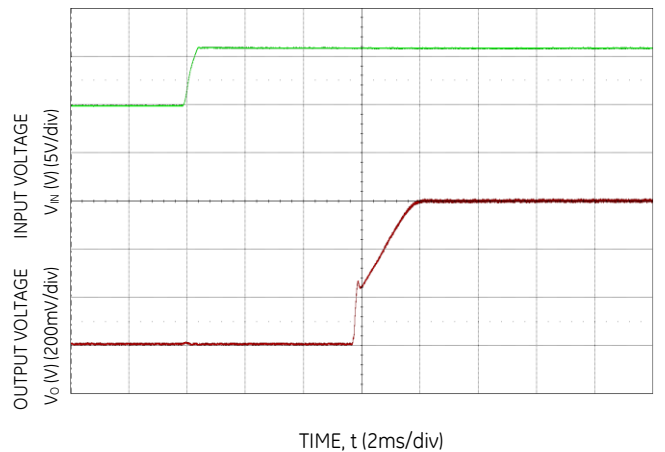

Figure 6. Typical Start-up Using Input Voltage (V_{IN} = 12V, I_o = I_{o,max}).

6A Analog FemtoDLynxII™: Non-Isolated DC-DC Power Modules

4.5Vdc – 14.4Vdc input; 0.6Vdc to 5.5Vdc output; 6A Output Current

Characteristic Curves

The following figures provide typical characteristics for the 6A Analog FemtoDLynxII™ at 1.2Vo and 25°C.

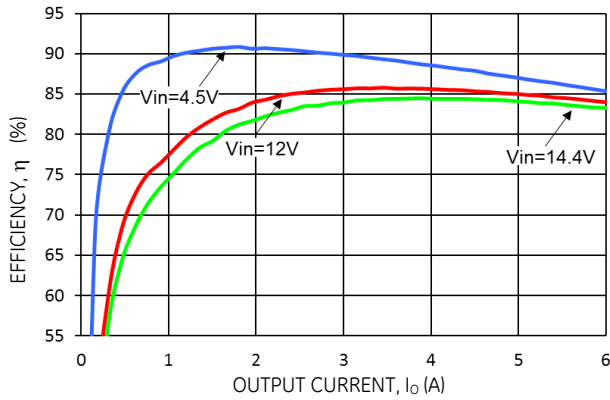

Figure 7. Converter Efficiency versus Output Current.

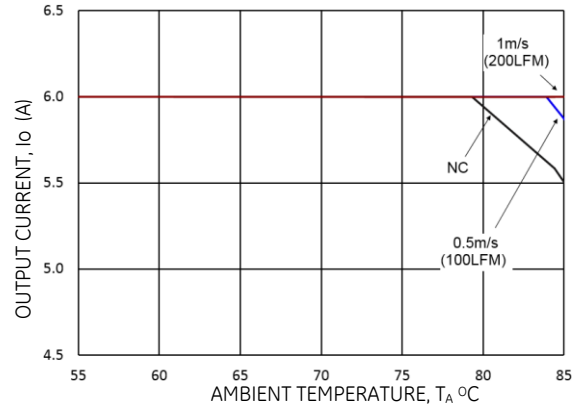

Figure 8. Derating Output Current versus Ambient Temperature and Airflow.

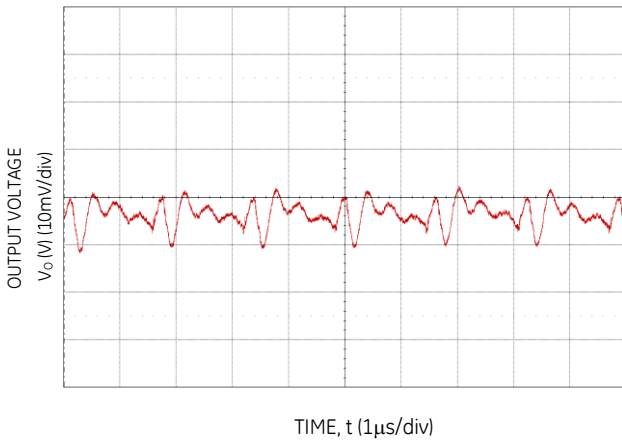

Figure 9. Typical output ripple and noise ($C_o=88\mu\text{F}$ ceramic, $V_{IN} = 12\text{V}$, $I_o = I_{o,max}$).

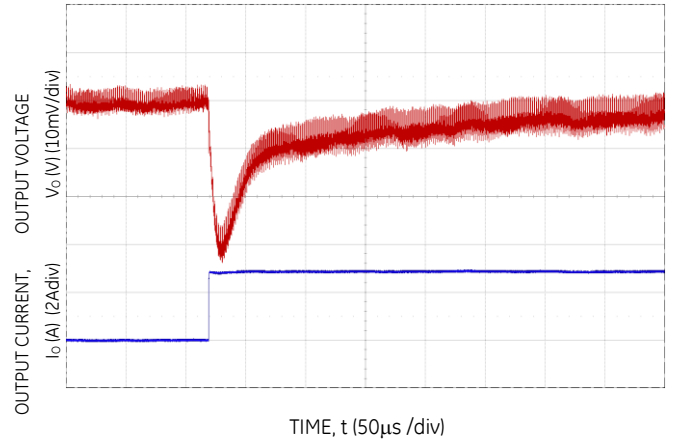

Figure 10. Transient Response to Dynamic Load Change from 50% to 100% at 12Vin, Cout-1x330μF, 4x100μF, Ctune-4.7nF, Rtune-500

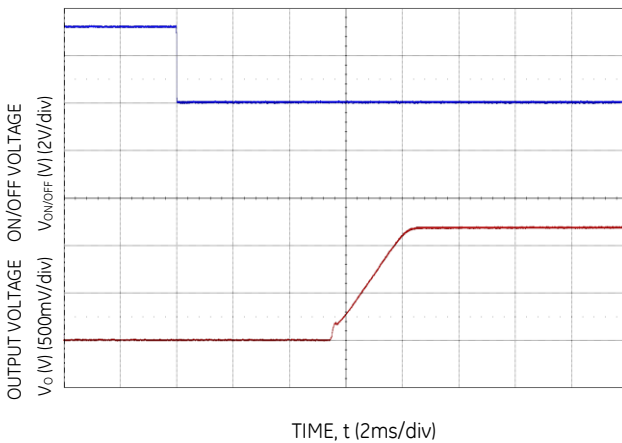

Figure 11. Typical Start-up Using On/Off Voltage ($I_o = I_{o,max}$).

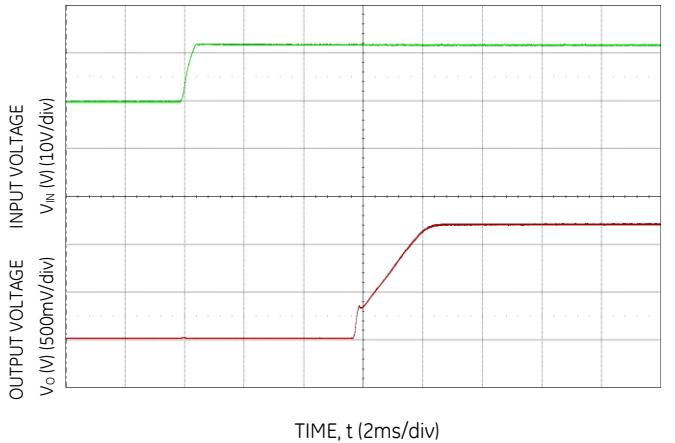

Figure 12. Typical Start-up Using Input Voltage ($V_{IN} = 12\text{V}$, $I_o = I_{o,max}$).

6A Analog FemtoDLynxII™: Non-Isolated DC-DC Power Modules

4.5Vdc – 14.4Vdc input; 0.6Vdc to 5.5Vdc output; 6A Output Current

Characteristic Curves

The following figures provide typical characteristics for the 6A Analog FemtoDLynxII™ at 1.8V_o and 25°C.

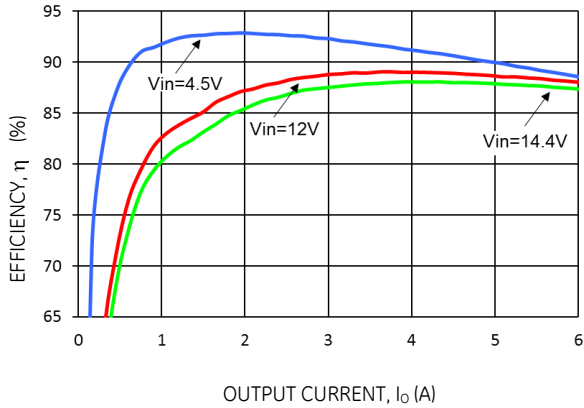

Figure 13. Converter Efficiency versus Output Current.

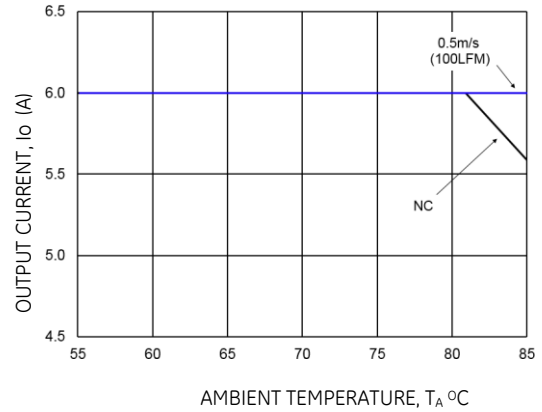

Figure 14. Derating Output Current versus Ambient Temperature and Airflow.

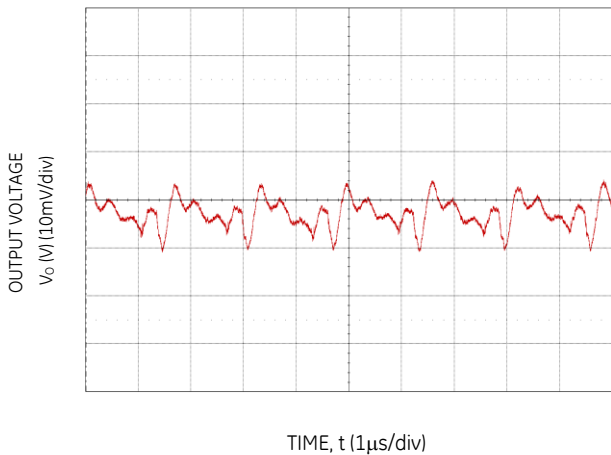

Figure 15. Typical output ripple and noise ($C_o=88\mu\text{F}$ ceramic, $V_{IN} = 12\text{V}$, $I_o = I_{o,max}$).

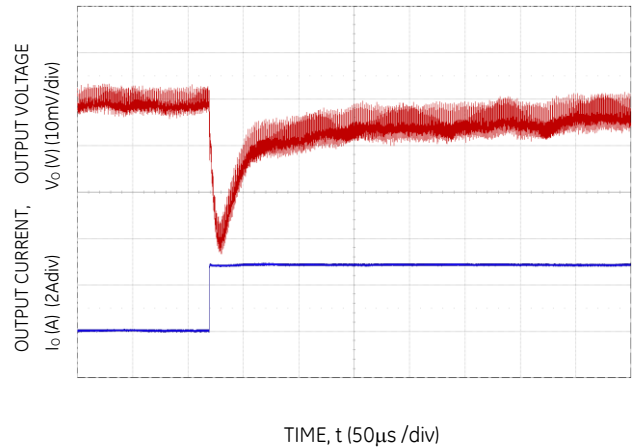

Figure 16. Transient Response to Dynamic Load Change from 50% to 100% at 12V_{in}, C_{out}-1x330µF, 4x100µF, C_{tune}-4.7nF, R_{tune}-500

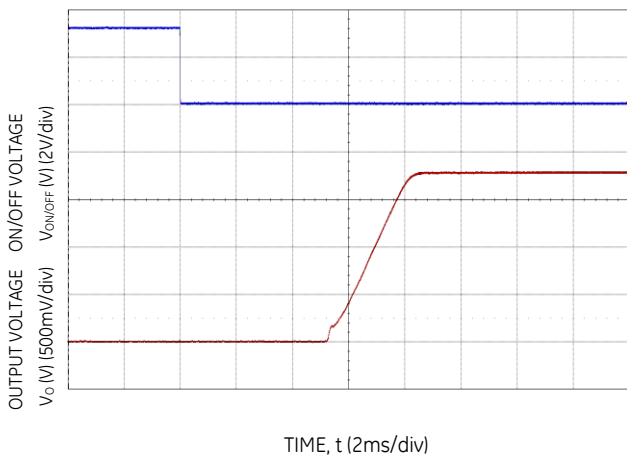

Figure 17. Typical Start-up Using On/Off Voltage ($I_o = I_{o,max}$).

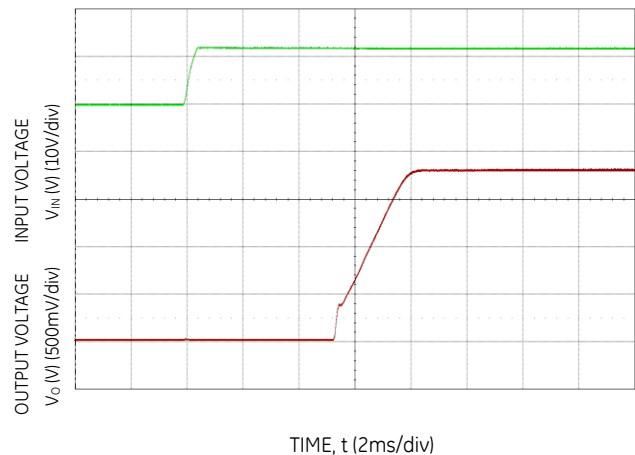

Figure 18. Typical Start-up Using Input Voltage ($V_{IN} = 12\text{V}$, $I_o = I_{o,max}$).

6A Analog FemtoDLynxII™: Non-Isolated DC-DC Power Modules

4.5Vdc – 14.4Vdc input; 0.6Vdc to 5.5Vdc output; 6A Output Current

Characteristic Curves

The following figures provide typical characteristics for the 6A Analog FemtoDLynxII™ at 2.5Vo and 25°C.

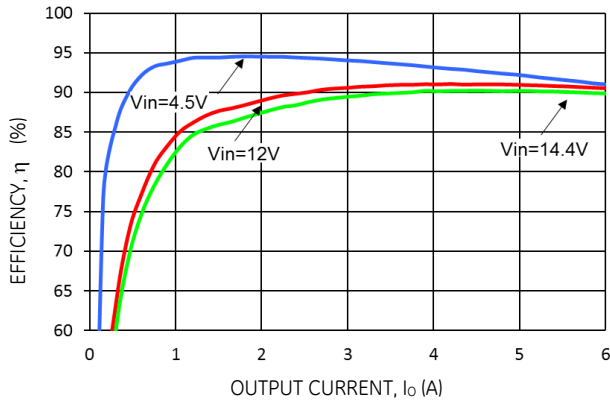

Figure 19. Converter Efficiency versus Output Current.

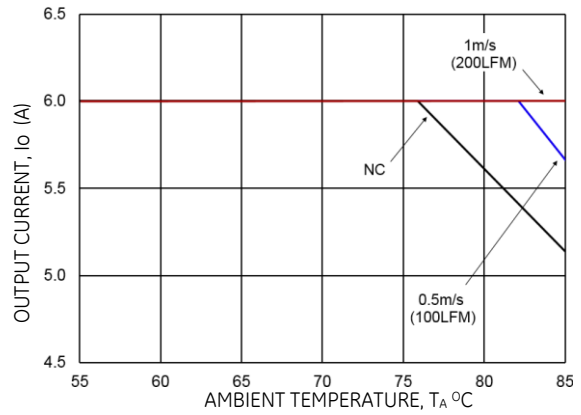

Figure 20. Derating Output Current versus Ambient Temperature and Airflow.

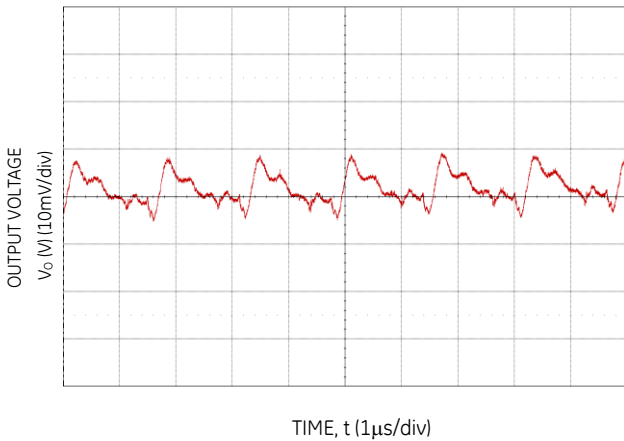

Figure 21. Typical output ripple and noise ($C_o=88\mu\text{F}$ ceramic, $V_{IN} = 12\text{V}$, $I_o = I_{o,max}$).

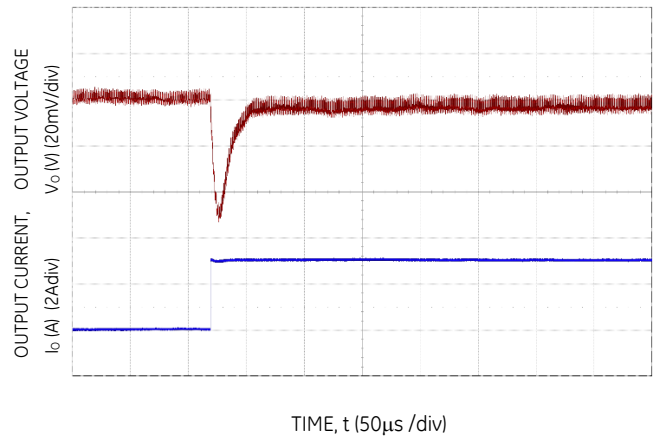

Figure 22. Transient Response to Dynamic Load Change from 50% to 100% at 12Vin, $C_{out}=5 \times 100\mu\text{F}$, $C_{tune}=3.3\text{nF}$, $R_{tune}=500$

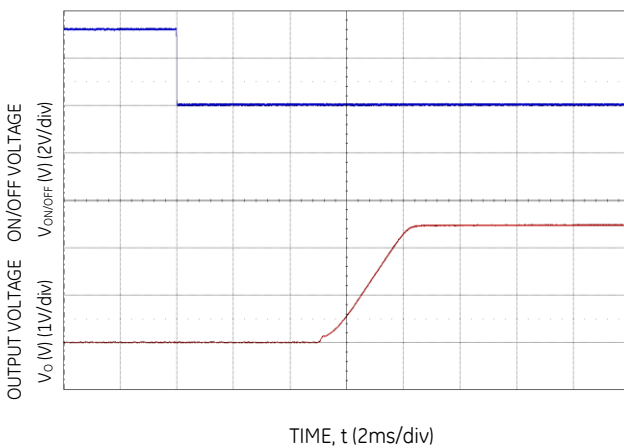

Figure 23. Typical Start-up Using On/Off Voltage ($I_o = I_{o,max}$).

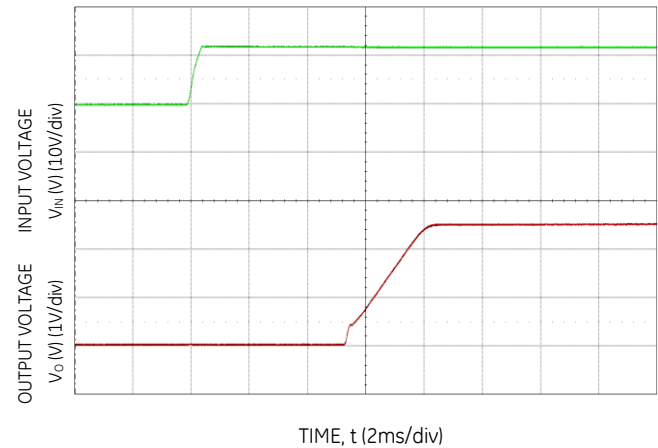

Figure 24. Typical Start-up Using Input Voltage ($V_{IN} = 12\text{V}$, $I_o = I_{o,max}$).

6A Analog FemtoDLynxII™: Non-Isolated DC-DC Power Modules

4.5Vdc – 14.4Vdc input; 0.6Vdc to 5.5Vdc output; 6A Output Current

Characteristic Curves

The following figures provide typical characteristics for the 6A Analog FemtoDLynxII™ at 3.3V_o and 25°C.

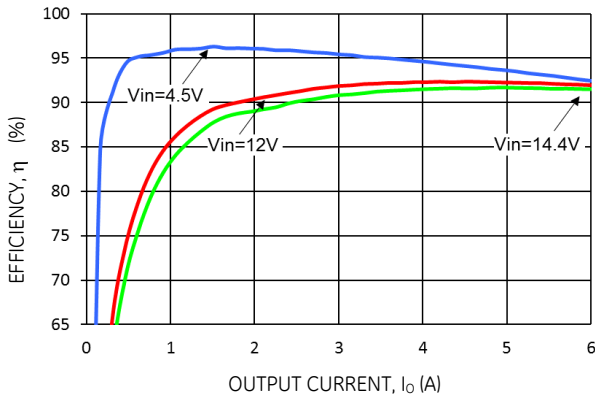

Figure 25. Converter Efficiency versus Output Current.

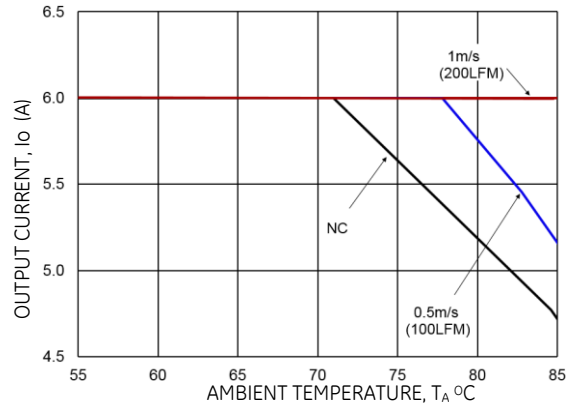

Figure 26. Derating Output Current versus Ambient Temperature and Airflow.

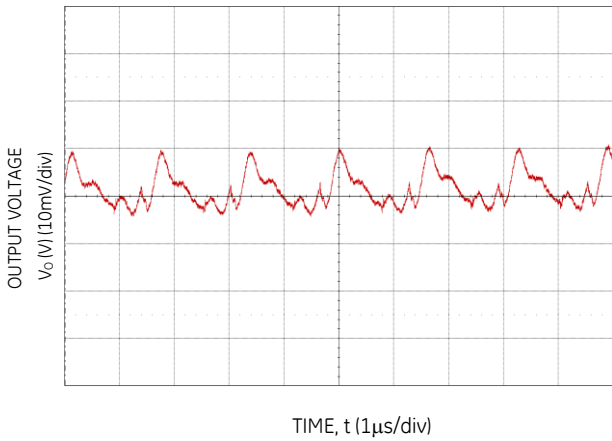

Figure 27. Typical output ripple and noise (C_o=88µF ceramic, V_{IN} = 12V, I_o = I_{o,max}).

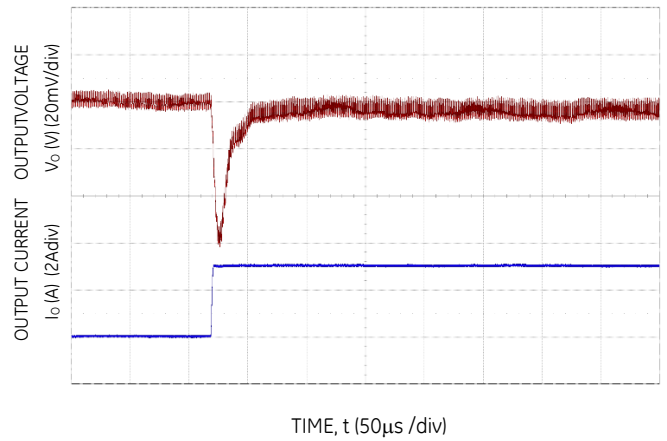

Figure 28. Transient Response to Dynamic Load Change from 50% to 100% at 12Vin, C_{out}-4x100µF, C_{tune}-2.2nF, R_{tune}-500

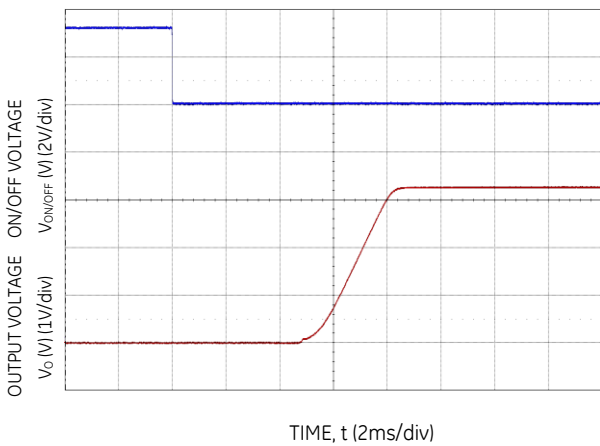

Figure 29. Typical Start-up Using On/Off Voltage (I_o = I_{o,max}).

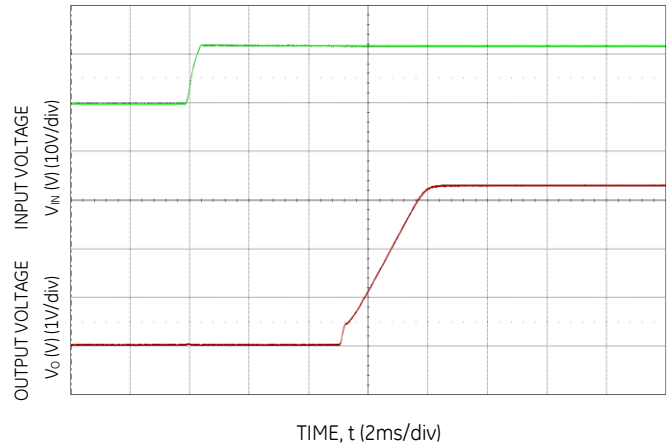

Figure 30. Typical Start-up Using Input Voltage (V_{IN} = 12V, I_o = I_{o,max}).

6A Analog FemtoDLynxII™: Non-Isolated DC-DC Power Modules

4.5Vdc – 14.4Vdc input; 0.6Vdc to 5.5Vdc output; 6A Output Current

Characteristic Curves

The following figures provide typical characteristics for the 6A Analog FemtoDLynxII™ at 5Vo and 25°C.

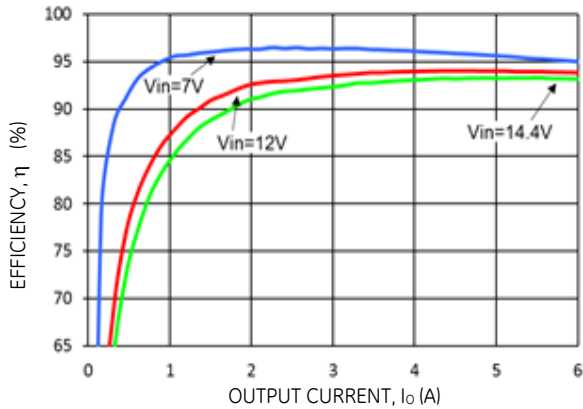

Figure 31. Converter Efficiency versus Output Current.

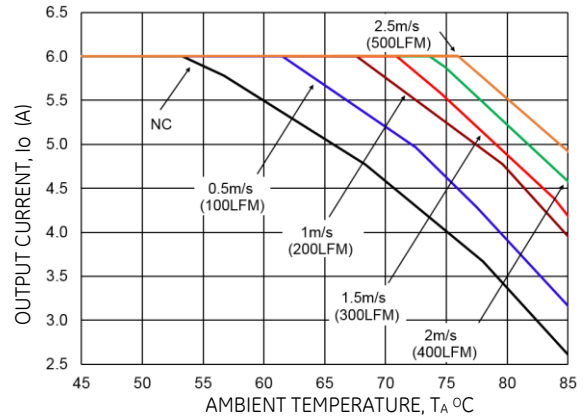

Figure 32. Derating Output Current versus Ambient Temperature and Airflow.

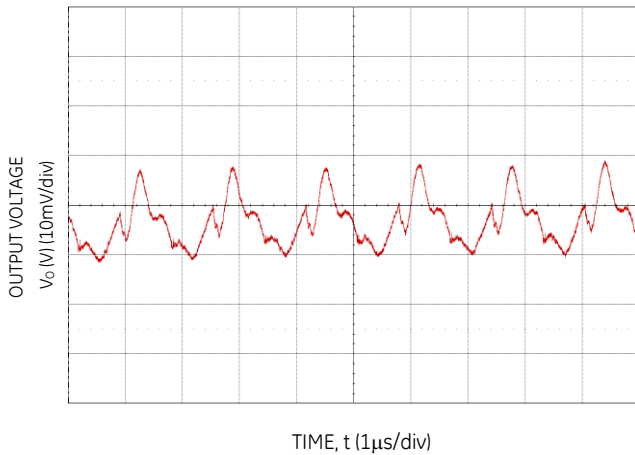

Figure 33. Typical output ripple and noise (Co=88µF ceramic, VIN = 12V, Io = Io,max).

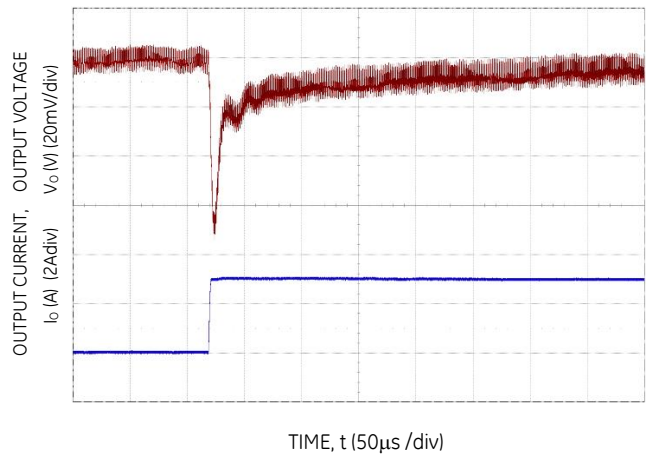

Figure 34. Transient Response to Dynamic Load Change from 50% to 100% at 12Vin, Cout=3x100µF, Ctune=1.5nF, Rtune=500

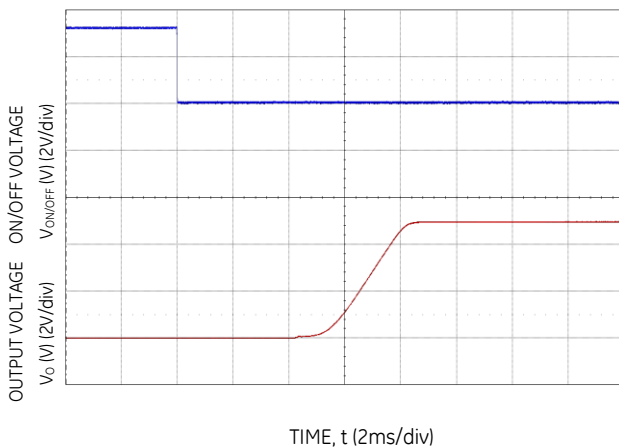

Figure 35. Typical Start-up Using On/Off Voltage (Io = Io,max).

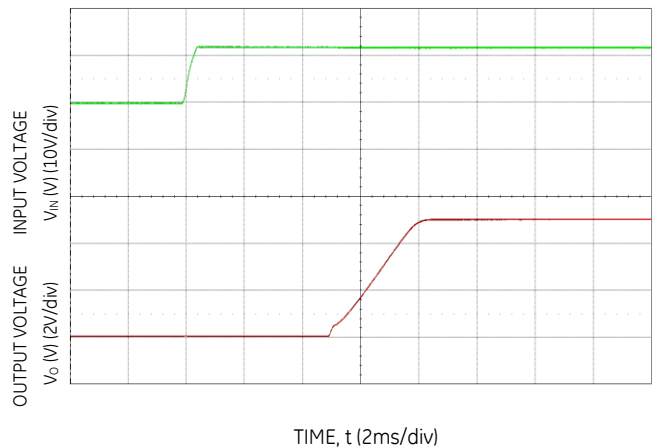

Figure 36. Typical Start-up Using Input Voltage (VIN = 12V, Io = Io,max).

6A Analog FemtoDLynxII™: Non-Isolated DC-DC Power Modules

4.5Vdc –14.4Vdc input; 0.6Vdc to 5.5Vdc output; 6A Output Current

Design Considerations

Input Filtering

The 6A Analog FemtoDLynxII™ module should be connected to a low ac-impedance source. A highly inductive source can affect the stability of the module. An input capacitance must be placed directly adjacent to the input pin of the module, to minimize input ripple voltage and ensure module stability.

To minimize input voltage ripple, ceramic capacitors are recommended at the input of the module. Figure 37 shows the input ripple voltage for various output voltages at 6A of load current with 2x22 μF or 4x22μF ceramic capacitors and an input of 12V.

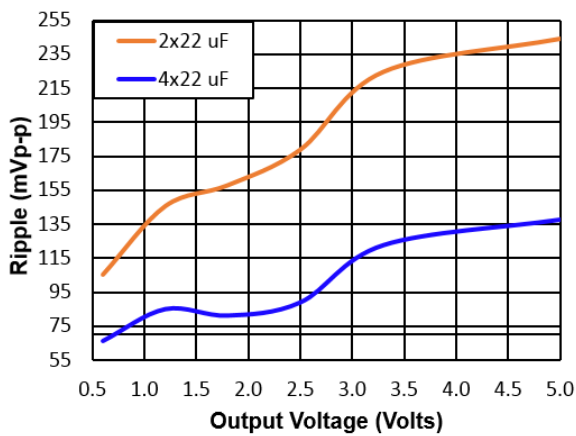

Figure 37. Input ripple voltage for various output voltages with 2x22μF or 4x22μF ceramic capacitors at the input (6A load). Input voltage is 12V.

Output Filtering

These modules are designed for low output ripple voltage and will meet the maximum output ripple specification with 0.1μF ceramic and 2x22μF ceramic capacitors at the output of the module. However, additional output filtering may be required by the system designer for a number of reasons. First, there may be a need to further reduce the output ripple and noise of the module. Second, the dynamic response characteristics may need to be customized to a particular load step change.

To reduce the output ripple and improve the dynamic response to a step load change, additional capacitance at the output can be used. Low ESR polymer and ceramic capacitors are recommended to improve the dynamic response of the module. Figure 38 provides output ripple information for different external capacitance values at various Vo and a full load current of 6A. For stable operation of the module, limit the capacitance to less than the maximum output capacitance as specified in the electrical specification table. Optimal performance of the module can be achieved by using the Tunable Loop™ feature described later in this data sheet

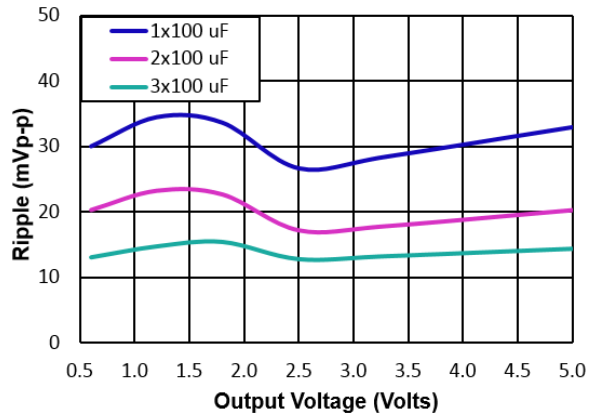

Figure 38. Output ripple voltage for various output voltages with external 1x100μF, 2x100μF, and 3x100μF ceramic capacitors at the output (6A load). Input voltage is 12V.

Safety Considerations

For safety agency approval the power module must be installed in compliance with the spacing and separation requirements of the end-use safety agency standards, i.e., ANSI/UL# 60950-1 2nd Revised October 14, 2014, CSA† C22.2 No. 60950-1-07, Second Ed. + A2:2014 (MOD) Recognized, DIN EN 60950-1:2006 + A11:2009 + A1:2010 +A12:2011, + A2:2013 (VDE† 0805-1) Licensed.

For the converter output to be considered meeting the requirements of safety extra-low voltage (SELV), the input must meet SELV requirements. The power module has extra-low voltage (ELV) outputs when all inputs are ELV.

The input to these units is to be provided with a fast-acting fuse with a maximum rating of 10 A, 125Vdc in the positive input lead.

6A Analog FemtoDLynxII™: Non-Isolated DC-DC Power Modules

4.5Vdc –14.4Vdc input; 0.6Vdc to 5.5Vdc output; 6A Output Current

Feature Descriptions

Remote On/Off

The 6A Analog FemtoDLynxII™ power modules feature an On/Off pin for remote On/Off operation. The Negative Logic On/Off module turns OFF during logic High and ON during logic Low. The On/Off signal should be always referenced to ground. Leaving the On/Off pin disconnected will turn the module ON when input voltage is present.

The logic on/off circuit configuration is shown in Fig. 40. The On/Off pin should be pulled high with an external pull-up resistor (suggested value for the 4.5 to 14.4V input range is 20kohms). When transistor Q1 is in the OFF state, the On/Off pin is pulled high, internal transistor Q4 is turned ON and the module is OFF. To turn the module ON, Q1 is turned ON pulling the On/Off pin low, turning transistor Q4 OFF resulting in the PWM Enable pin going high and the module turning ON.

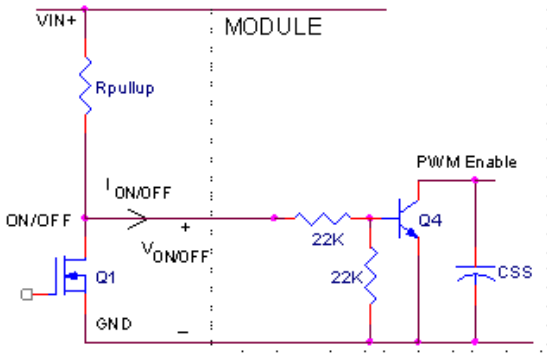

Figure 40. Circuit configuration for using negative On/Off logic.

Monotonic Start-up and Shutdown

The module has monotonic start-up and shutdown behavior for any combination of rated input voltage, output current and operating temperature range.

Startup into Pre-biased Output

The modules can start into a prebiased output as long as the prebias voltage is 0.5V less than the set output voltage for output voltages $V_o \leq 1.8V$.

Output Voltage Programming

The output voltage of the module is programmable to any voltage from 0.6dc to 5.5Vdc by connecting a resistor between the Trim and GND pins of the module. Certain restrictions apply on the output voltage set point depending on the input voltage. These are shown in the Output Voltage vs. Input Voltage Set Point Area plot in Fig. 41. The Upper Limit curve shows that for output voltages lower than 1V, the input voltage must be lower than the maximum of 14V. The Lower Limit curve shows that for output voltages higher than 0.6V, the input voltage needs to be larger than the minimum of 4.5V.

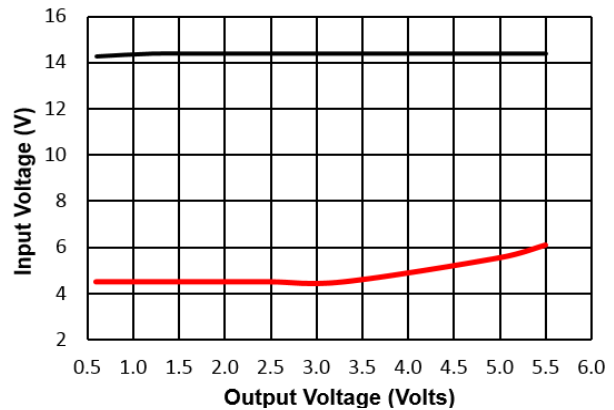

Figure 41. Output Voltage vs. Input Voltage Set Point Area plot showing limits where the output voltage can be set for different input voltages.

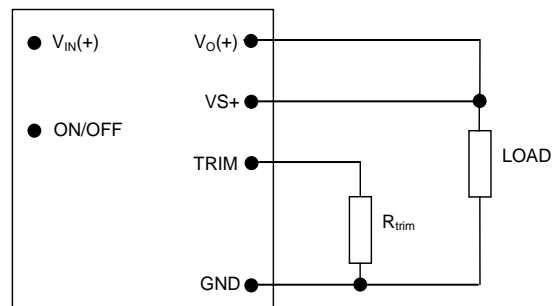

Figure 42. Circuit configuration for programming output voltage using an external resistor.

Without an external resistor between Trim and GND pins, the output of the module will be 0.6Vdc. To calculate the value of the trim resistor, R_{trim} for a desired output voltage, should be as per the following equation:

$$R_{trim} = \left[\frac{12}{(V_o - 0.6)} \right] k\Omega$$

R_{trim} is the external resistor in $k\Omega$

V_o is the desired output voltage.

Table 1

$V_{o, set} (V)$	$R_{trim} (k\Omega)$
0.6	Open
0.9	40
1.0	30
1.2	20
1.5	13.33
1.8	10
2.5	6.316
3.3	4.444
5.0	2.727

6A Analog FemtoDLynxII™: Non-Isolated DC-DC Power Modules

4.5Vdc –14.4Vdc input; 0.6Vdc to 5.5Vdc output; 6A Output Current

Remote Sense

The power module has a Remote Sense feature to minimize the effects of distribution losses by regulating the voltage at the SENSE pin. The voltage between the SENSE pin and VOUT pin should not exceed 0.5V.

Voltage Margining

Output voltage margining can be implemented in the module by connecting a resistor, $R_{\text{margin-up}}$, from the Trim pin to the ground pin for margining-up the output voltage and by connecting a resistor, $R_{\text{margin-down}}$, from the Trim pin to output pin for margining-down. Figure 43 shows the circuit configuration for output voltage margining. The Power Module Wizard, available at <http://ge.transim.com/pmd/Home> also calculates the values of $R_{\text{margin-up}}$ and $R_{\text{margin-down}}$ for a specific output voltage and % margin. Please consult your local GE technical representative for additional details.

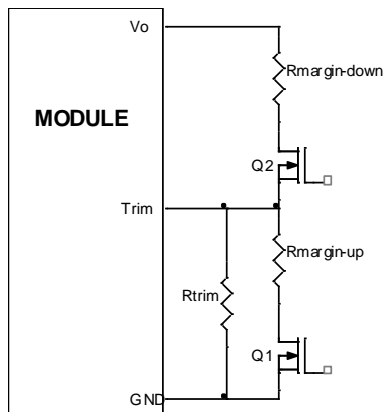

Figure 43. Circuit Configuration for margining Output voltage.

Overcurrent Protection

To provide protection in a fault (output overload) condition, the unit is equipped with internal current-limiting circuitry and can endure current limiting continuously. At the point of current-limit inception, the unit enters hiccup mode. The unit operates normally once the output current is brought back into its specified range.

Overtemperature Protection

To provide protection in a fault condition, the unit is equipped with a thermal shutdown circuit. The unit will shutdown if the overtemperature threshold of 150°C (typ) is exceeded at the thermal reference point T_{ref} . Once the unit goes into thermal shutdown it will then wait to cool before attempting to restart.

Input Undervoltage Lockout

At input voltages below the input undervoltage lockout limit, the module operation is disabled. The module will begin to operate at an input voltage above the undervoltage lockout turn-on threshold.

Power Good

The module provides a Power Good (PGOOD) signal that is implemented with an open-drain output to indicate that the output voltage is within the regulation limits of the power module. The PGOOD signal will be de-asserted to a low state if any condition such as overtemperature, overcurrent or loss of regulation occurs that would result in the output voltage going $\pm 10\%$ outside the setpoint value. The PGOOD terminal can be connected through a pullup resistor (suggested value 100K Ω) to a source of 5VDC or lower.

6A Analog FemtoDLynxII™: Non-Isolated DC-DC Power Modules

4.5Vdc –14.4Vdc input; 0.6Vdc to 5.5Vdc output; 6A Output Current

Tunable Loop™

The 6A FemtoDLynxII™ modules have a feature that optimizes transient response of the module called Tunable Loop™.

External capacitors are usually added to the output of the module for two reasons: to reduce output ripple and noise (see Figure 38) and to reduce output voltage deviations from the steady-state value in the presence of dynamic load current changes. Adding external capacitance however affects the voltage control loop of the module, typically causing the loop to slow down with sluggish response. Larger values of external capacitance could also cause the module to become unstable.

The Tunable Loop™ allows the user to externally adjust the voltage control loop to match the filter network connected to the output of the module. The Tunable Loop™ is implemented by connecting a series R-C between the SENSE and TRIM pins of the module, as shown in Fig. 45. This R-C allows the user to externally adjust the voltage loop feedback compensation of the module.

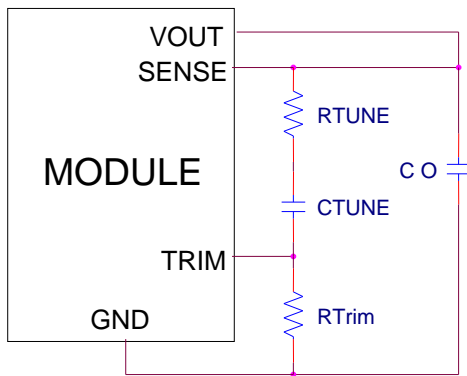

Figure. 45. Circuit diagram showing connection of R_{TUNE} and C_{TUNE} to tune the control loop of the module.

Recommended values of R_{TUNE} and C_{TUNE} for different output capacitor combinations are given in Tables 2 and 3. Table 2 shows the recommended values of R_{TUNE} and C_{TUNE} for different values of ceramic output capacitors up to 1000 μ F that might be needed for an application to meet output ripple and noise requirements. Selecting R_{TUNE} and C_{TUNE} according to Table 2 will ensure stable operation of the module.

In applications with tight output voltage limits in the presence of dynamic current loading, additional output capacitance will be required. Table 3 lists recommended values of R_{TUNE} and C_{TUNE} in order to meet 4% output voltage deviation limits for some common output voltages in the presence of a 3A to 6A step change (50% of full load), with an input voltage of 12V.

Please contact your GE technical representative to obtain more details of this feature as well as for guidelines on how to select the right value of external R-C to tune the module for best transient performance and stable operation for other output capacitance values or input voltages other than 12V.

Table 2. General recommended values of R_{TUNE} and C_{TUNE} for $V_{in}=12V$ and various external ceramic capacitor combinations.

C_o	1x100 μ F	2x100 μ F	4x100 μ F	6x100 μ F	10x100 μ F
R_{TUNE}	500	500	500	500	200
C_{TUNE}	470pF	1500pF	2200pF	3300pF	6800pF

Table 3. Recommended values of R_{TUNE} and C_{TUNE} to obtain transient deviation of 4% of V_{out} for a 3A step load with $V_{in}=12V$.

V_o	5V	3.3V	2.5V	1.8V	1.2V	0.6V
C_o	3x100 μ F	4x100 μ F	5x100 μ F	4x100 μ F + 1x330 μ F Polymer	4x100 μ F + 1x330 μ F Polymer	6x100 μ F + 2x330 μ F Polymer
R_{TUNE}	500	500	500	500	500	500
C_{TUNE}	1500pF	2200pF	3300pF	4700pF	4700pF	10nF
ΔV	68mV	57mV	50mV	30mV	31mV	20mV

Note: The capacitors used in the Tunable Loop tables are 100 μ F/2 m Ω ESR ceramic and 330 μ F/12 m Ω ESR polymer capacitors.

Power Module Wizard™

GE offers a free web based easy to use tool that helps users simulate the Tunable Loop performance of the FKX006. Go to <http://ge.transim.com/pmd/Home> and sign up for a free account and use the module selector tool. The tool also offers downloadable Simplis/Simatrix models that can be used to assess transient performance, module stability, etc.

6A Analog FemtoDLynxII™: Non-Isolated DC-DC Power Modules

4.5Vdc –14.4Vdc input; 0.6Vdc to 5.5Vdc output; 6A Output Current

Thermal Considerations

Power modules operate in a variety of thermal environments; however, sufficient cooling should always be provided to help ensure reliable operation.

Considerations include ambient temperature, airflow, module power dissipation, and the need for increased reliability. A reduction in the operating temperature of the module will result in an increase in reliability. The thermal data presented here is based on physical measurements taken in a wind tunnel. The test set-up is shown in Figure 46. The preferred airflow direction for the module is in Figure 47.

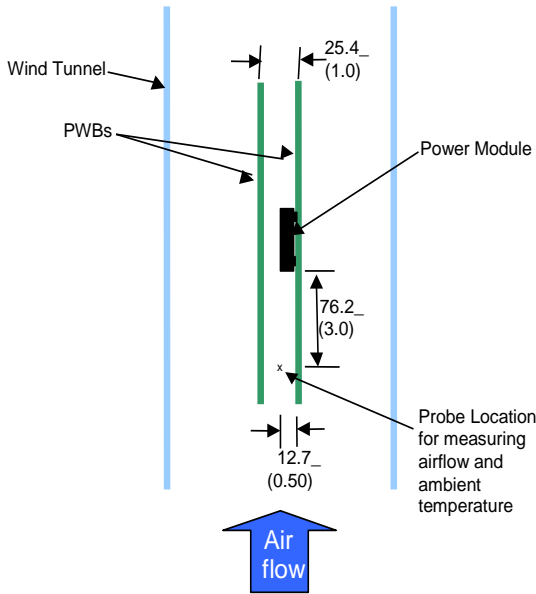

Figure 46. Thermal Test Setup.

The thermal reference points, T_{ref} used in the specifications are also shown in Figure 47. For reliable operation the temperatures at these points should not exceed 120°C. The output power of the module should not exceed the rated power of the module ($V_{o,set} \times I_{o,max}$).

Please refer to the Application Note “Thermal Characterization Process For Open-Frame Board-Mounted Power Modules” for a detailed discussion of thermal aspects including maximum device temperatures.

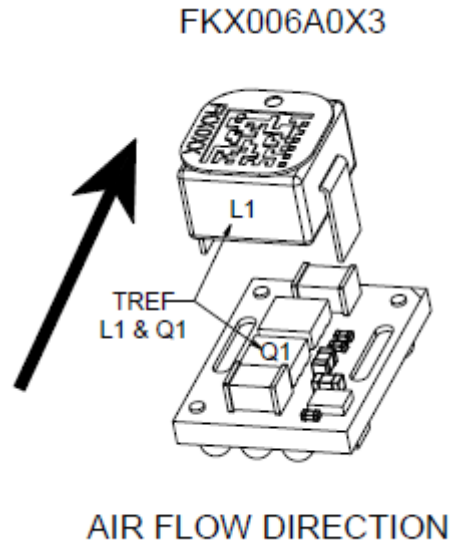

Figure 47. Preferred airflow direction and location of hot-spots of the module (T_{ref}).

6A Analog FemtoDLynxII™: Non-Isolated DC-DC Power Modules

4.5Vdc –14.4Vdc input; 0.6Vdc to 5.5Vdc output; 6A Output Current

Example Application Circuit

Requirements:

Vin:	12V
Vout:	1.8V
Iout:	4.5A max., worst case load transient is from 3.0A to 4.5A
ΔVout:	1.5% of Vout (27mV) for worst case load transient
Vin, ripple	1.5% of Vin (180mV, p-p)

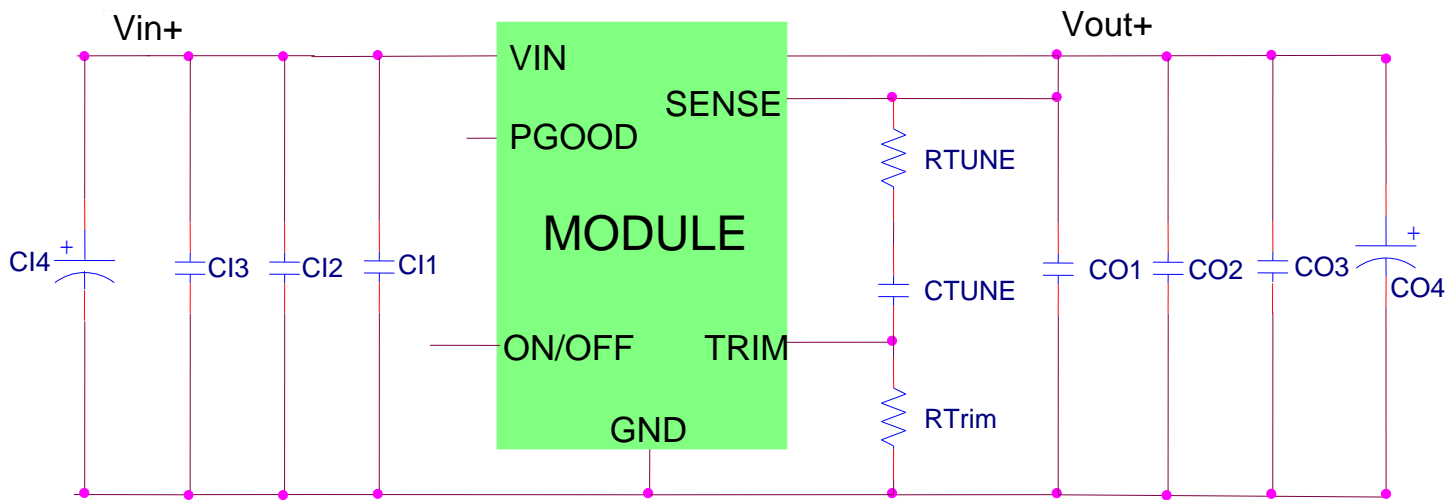

C11	Decoupling cap – 0.1μF/16V ceramic capacitor (e.g. Murata GRM155R71C104KA88D)
C12	22μF/16V ceramic capacitor (e.g. Murata GRM32ER71C226MEA8L)
C13	22μF/16V ceramic capacitor (e.g. Murata GRM32ER71C226MEA8L)
C14	470μF/16V electrolytic
CO1	Decoupling cap – 0.1μF/6.3V ceramic capacitor (e.g. Murata GRM155R70J104KA01D)
CO2	100μF/6.3V ceramic capacitor (e.g. Murata GRM32EC70J107ME15L)
CO3	100μF/6.3V ceramic capacitor (e.g. Murata GRM32EC70J107ME15L)
CO4	330μF/6.3V Polymer (e.g. Panasonic Poscap)
CTune	3300pF ceramic capacitor (can be 1206, 0805, or 0603 size)
RTune	500Ω SMT resistor (can be 1206, 0805, or 0603 size)
RTrim	10kΩ SMT resistor (can be 1206, 0805 or 0603 size, recommended tolerance of 0.1%)

6A Analog FemtoDLynxII™: Non-Isolated DC-DC Power Modules

4.5Vdc –14.4Vdc input; 0.6Vdc to 5.5Vdc output; 6A Output Current

Mechanical Outline

Dimensions are in inches.

Tolerances: X.XXX in ± 0.020 in., [X.XX mm ±0.50mm]

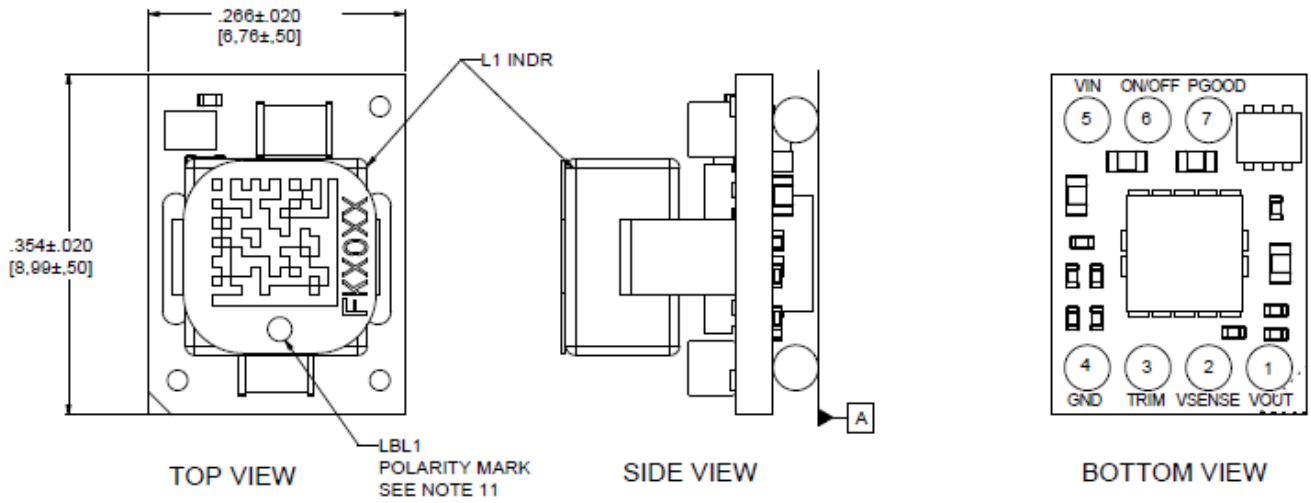

6A Analog FemtoDLynxII™: Non-Isolated DC-DC Power Modules

4.5Vdc –14.4Vdc input; 0.6Vdc to 5.5Vdc output; 6A Output Current

Recommended Pad Layout

Dimensions are in inches.

Tolerances: X.XXX in ± 0.010 in., [X.XX mm ±0.25mm]

RECOMMENDED FOOTPRINT - THROUGH THE BOARD -

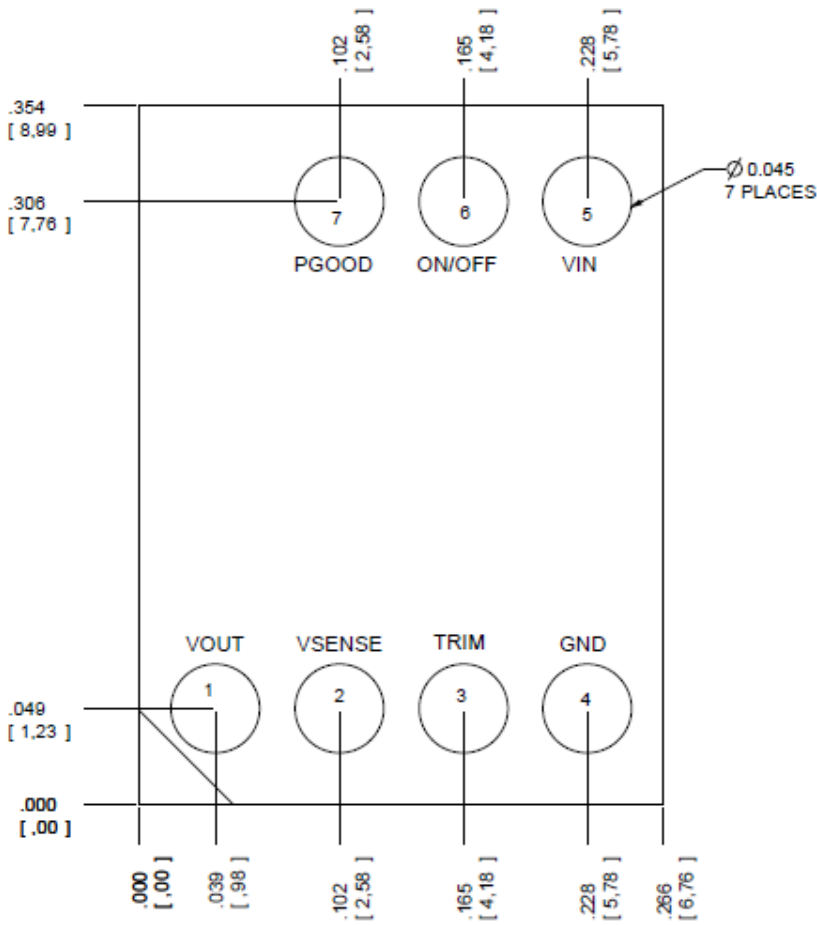

PIN	FUNCTION
1	VOUT
2	VSENSE
3	TRIM
4	GND
5	VIN
6	ON/OFF
7	PGOOD

6A Analog FemtoDLynxII™: Non-Isolated DC-DC Power Modules

4.5Vdc –14.4Vdc input; 0.6Vdc to 5.5Vdc output; 6A Output Current

Packaging Details

The 12V Analog FemtoDLynxII™ 6A modules are supplied in tape & reel as standard. Modules are shipped in quantities of 300 modules per reel.

All Dimensions are in inches and (in millimeters).

Dimensions in (inches) are for reference.

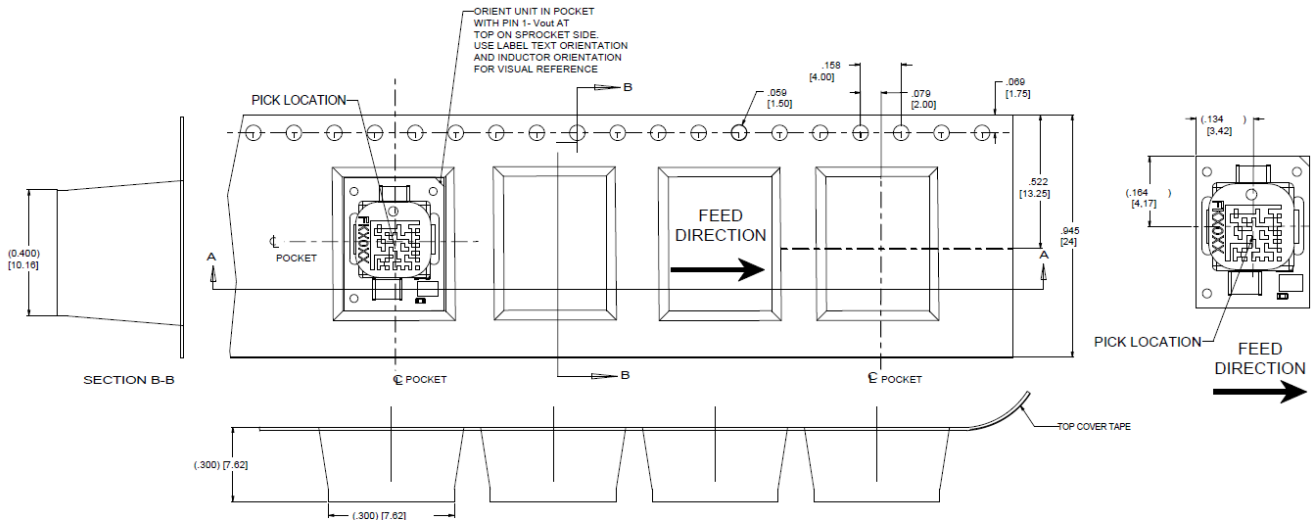

Reel Dimensions:	
Outside Dimensions:	330.2 mm (13.00)
Inside Dimensions:	177.8 mm (7.00")
Tape Width:	24.00 mm (0.945")

6A Analog FemtoDLynxII™: Non-Isolated DC-DC Power Modules

4.5Vdc –14.4Vdc input; 0.6Vdc to 5.5Vdc output; 6A Output Current

Surface Mount Information

Pick and Place

The 12VAnalog FemtoDLynxII™ 6A modules use an open frame construction and are designed for a fully automated assembly process. The modules are fitted with a label designed to provide a large surface area for pick and place operations. The label meets all the requirements for surface mount processing, as well as safety standards, and is able to withstand reflow temperatures of up to 300°C. The label also carries product information such as product code, serial number and the location of manufacture.

Nozzle Recommendations

The module weight has been kept to a minimum by using open frame construction. Variables such as nozzle size, tip style, vacuum pressure and placement speed should be considered to optimize this process. The minimum recommended inside nozzle diameter for reliable operation is 2 mm. The maximum nozzle outer diameter, which will safely fit within the allowable component spacing, is 5 mm.

Bottom Side / First Side Assembly

This module is not recommended for assembly on the bottom side of a customer board. If such an assembly is attempted, components may fall off the module during the second reflow process.

Lead Free Soldering

The 12VAnalog FemtoDLynxII™ 6A modules are lead-free (Pb-free) and RoHS compliant and are both forward and backward compatible in a Pb-free and a SnPb soldering process. Failure to observe the instructions below may result in the failure of or cause damage to the modules and can adversely affect long-term reliability.

Pb-free Reflow Profile

Power Systems will comply with J-STD-020 Rev. C (Moisture/Reflow Sensitivity Classification for Nonhermetic Solid State Surface Mount Devices) for both Pb-free solder profiles and MSL classification procedures. This standard provides a recommended forced-air-convection reflow profile based on the volume and thickness of the package (table 5-2). The suggested Pb-free solder paste is Sn/Ag/Cu (SAC). For questions regarding solder volume; please contact GE for special manufacturing process instructions.

The recommended linear reflow profile using Sn/Ag/Cu solder is shown in Fig. 48. Soldering outside of the recommended profile requires testing to verify results and performance.

It is recommended that the pad layout include a test pad where the output pin is in the ground plane. The thermocouple should be attached to this test pad since this will be the coolest solder joints. The temperature of this point should be: Maximum peak temperature is 260 C. Minimum temperature is 235 C. Dwell time above 217 C: 60 seconds minimum Dwell time above 235 C: 5 to 15 second

MSL Rating

The 12VAnalog FemtoDLynxII™ 6A modules have a MSL rating of 2a.

Storage and Handling

The recommended storage environment and handling procedures for moisture-sensitive surface mount packages is detailed in J-STD-033 Rev. B (Handling, Packing, Shipping and Use of Moisture/Reflow Sensitive Surface Mount Devices). Moisture barrier bags (MBB) with desiccant are required for MSL ratings of 2 or greater. These sealed packages should not be broken until time of use. Once the original package is broken, the floor life of the product at conditions of $\leq 30^{\circ}\text{C}$ and 60% relative humidity varies according to the MSL rating (see J-STD-033A). The shelf life for dry packed SMT packages will be a minimum of 12 months from the bag seal date, when stored at the following conditions: $< 40^{\circ}\text{C}$, $< 90\%$ relative humidity.

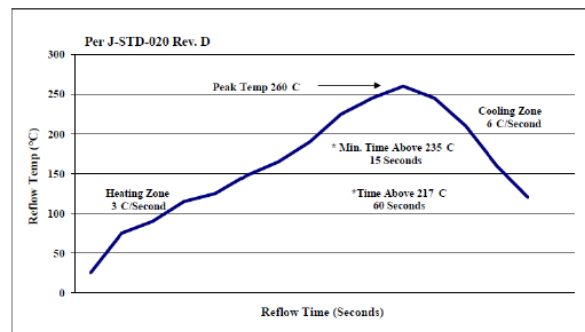

Figure 48. Recommended linear reflow profile using Sn/Ag/Cu solder.

Post Solder Cleaning and Drying Considerations

Post solder cleaning is usually the final circuit-board assembly process prior to electrical board testing. The result of inadequate cleaning and drying can affect both the reliability of a power module and the testability of the finished circuit-board assembly. For guidance on appropriate soldering, cleaning and drying procedures, refer to *Board Mounted Power Modules: Soldering and Cleaning* Application Note (AN04-001).

6A Analog FemtoDLynxII™: Non-Isolated DC-DC Power Modules

4.5Vdc –14.4Vdc input; 0.6Vdc to 5.5Vdc output; 6A Output Current

Ordering Information

Please contact your GE Sales Representative for pricing, availability and optional features.

Table 6. Device Codes

Device Code	Input Voltage Range	Output Voltage	Output Current	On/Off Logic	Sequencing	Comcodes
FKX006A0X3-SRZ	4.5 – 14.4Vdc	0.6 – 5.5Vdc	6A	Negative	No	150052668

-Z refers to RoHS compliant parts

Table 7. Coding Scheme

Package Identifier	Family	Sequencing Option	Output current	Output voltage	On/Off logic	Remote Sense	Options	ROHS Compliance
F	K	X	006A0	X		3	-SR	Z
P=Pico U=Micro M=Mega G=Giga F=Femto	K = DLynxII Analog	T=with EZ Sequence X=without sequencing	6A	X = programm able output	No entry = negative	3 = Remote Sense	S = Surface Mount R = Tape & Reel	Z = ROHS6

Contact Us

For more information, call us at

USA/Canada:

+1 888 546 3243, or +1 972 244 9288

Asia-Pacific:

+86-21-53899666

Europe, Middle-East and Africa:

+49.89.878067-280

www.gecriticalpower.com



GE Critical Power reserves the right to make changes to the product(s) or information contained herein without notice, and no liability is assumed as a result of their use or application. No rights under any patent accompany the sale of any such product(s) or information.

Компания «Океан Электроники» предлагает заключение долгосрочных отношений при поставках импортных электронных компонентов на взаимовыгодных условиях!

Наши преимущества:

- Поставка оригинальных импортных электронных компонентов напрямую с производств Америки, Европы и Азии, а так же с крупнейших складов мира;
- Широкая линейка поставок активных и пассивных импортных электронных компонентов (более 30 млн. наименований);
- Поставка сложных, дефицитных, либо снятых с производства позиций;
- Оперативные сроки поставки под заказ (от 5 рабочих дней);
- Экспресс доставка в любую точку России;
- Помощь Конструкторского Отдела и консультации квалифицированных инженеров;
- Техническая поддержка проекта, помощь в подборе аналогов, поставка прототипов;
- Поставка электронных компонентов под контролем ВП;
- Система менеджмента качества сертифицирована по Международному стандарту ISO 9001;
- При необходимости вся продукция военного и аэрокосмического назначения проходит испытания и сертификацию в лаборатории (по согласованию с заказчиком);
- Поставка специализированных компонентов военного и аэрокосмического уровня качества (Xilinx, Altera, Analog Devices, Intersil, Interpoint, Microsemi, Actel, Aeroflex, Peregrine, VPT, Syfer, Eurofarad, Texas Instruments, MS Kennedy, Miteq, Cobham, E2V, MA-COM, Hittite, Mini-Circuits, General Dynamics и др.);

Компания «Океан Электроники» является официальным дистрибьютором и эксклюзивным представителем в России одного из крупнейших производителей разъемов военного и аэрокосмического назначения «JONHON», а так же официальным дистрибьютором и эксклюзивным представителем в России производителя высокотехнологичных и надежных решений для передачи СВЧ сигналов «FORSTAR».



JONHON

«JONHON» (основан в 1970 г.)

Разъемы специального, военного и аэрокосмического назначения:

(Применяются в военной, авиационной, аэрокосмической, морской, железнодорожной, горно- и нефтедобывающей отраслях промышленности)

«FORSTAR» (основан в 1998 г.)

ВЧ соединители, коаксиальные кабели, кабельные сборки и микроволновые компоненты:

(Применяются в телекоммуникациях гражданского и специального назначения, в средствах связи, РЛС, а так же военной, авиационной и аэрокосмической отраслях промышленности).



Телефон: 8 (812) 309-75-97 (многоканальный)

Факс: 8 (812) 320-03-32

Электронная почта: ocean@oceanchips.ru

Web: <http://oceanchips.ru/>

Адрес: 198099, г. Санкт-Петербург, ул. Калинина, д. 2, корп. 4, лит. А