



RN1810/RN1810E

2.4 GHz IEEE 802.11b/g/n Wireless Module

Features

- IEEE 802.11b/g/n Compliant Transceiver
- 2.4 GHz IEEE 802.11n Single Stream 1x1
- UART Interface to Host Controller (4-wire including RTS/CTS)
- Integrates Easily into Final Product - Minimizes Product Development, Provides Quicker Time to Market
- Configured using Simple ASCII Commands
- Fully Integrated Wireless Module with Voltage Regulation, Crystal, RF Matching Circuitry, Power Amplifier (PA), Low Noise Amplifier (LNA), and PCB Trace Antenna
- Ultra-Small W.FL Connector for External Antennas (RN1810E)
- Compact Surface Mount Module: 0.700" x 1.050" x 0.085" (17.8 mm x 26.7 mm x 2.2 mm)
- Castellated Surface Mount Pads for easy and reliable PCB mounting
- Environmentally Friendly, RoHS Compliant

Operational

- Single Operating Voltage: 3.15V to 3.45V (3.3V typical)
- Temperature Range: -40°C to +85°C Industrial
- Low-Current Consumption:
 - RX mode: 64 mA (typical)
 - TX mode: 246 mA at 18 dBm (typical)
- Power Saving Mode:
 - Sleep: 12 μ A (typical)

RF/Analog

- Frequency: 2.412 to 2.472 GHz
- Channels: 1-13
- Modulation: DSSS, CCK, BPSK, QPSK, 16QAM, and 64QAM
- Sensitivity: -94 dBm

Antenna

- Integral PCB Trace Antenna (RN1810)
- External Antenna (RN1810E)



Compliance

- Modular Certified for the United States (FCC) and Canada (IC)
- European R&TTE Directive Assessed Radio Module
- Australia, New Zealand, Korea, Taiwan, and Japan

Applications

- Utility and Smart Energy
- Consumer Electronics
- Industrial Controls
- Remote Device Management
- Retail
- Medical, Fitness, and Health Care

Networking

- Supports Infrastructure and SoftAp Networking Modes
- Built-In Networking Applications: IPv4/IPv6, TCP, UDP, DHCP, DNS, ICMP, ARP, HTTP, FTP, SNMP, and SSL/TLS
- Complete On-Board TCP/IP Networking
- Upgrade Firmware Over the Air using TFTP
- Supports Wi-Fi[®] Protected Setup (WPS)

RN1810/RN1810E

Table of Contents

1.0 Device Overview	3
2.0 Circuit Description	13
3.0 Application Information	15
4.0 Regulatory Approval	21
5.0 Electrical Characteristics	27
Appendix A: Revision History	29
The Microchip Web Site	31
Customer Change Notification Service	31
Customer Support	31
Product Identification System	33

TO OUR VALUED CUSTOMERS

It is our intention to provide our valued customers with the best documentation possible to ensure successful use of your Microchip products. To this end, we will continue to improve our publications to better suit your needs. Our publications will be refined and enhanced as new volumes and updates are introduced.

If you have any questions or comments regarding this publication, please contact the Marketing Communications Department via E-mail at docerrors@microchip.com. We welcome your feedback.

Most Current Data Sheet

To obtain the most up-to-date version of this data sheet, please register at our Worldwide Web site at:

<http://www.microchip.com>

You can determine the version of a data sheet by examining its literature number found on the bottom outside corner of any page. The last character of the literature number is the version number, (e.g., DS30000000A is version A of document DS30000000).

Errata

An errata sheet, describing minor operational differences from the data sheet and recommended workarounds, may exist for current devices. As device/documentation issues become known to us, we will publish an errata sheet. The errata will specify the revision of silicon and revision of document to which it applies.

To determine if an errata sheet exists for a particular device, please check with one of the following:

- Microchip's Worldwide Web site; <http://www.microchip.com>
- Your local Microchip sales office (see last page)

When contacting a sales office, please specify which device, revision of silicon and data sheet (include literature number) you are using.

Customer Notification System

Register on our web site at www.microchip.com to receive the most current information on all of our products.

1.0 DEVICE OVERVIEW

The RN1810 and RN1810E are low-power, 2.4 GHz, IEEE 802.11n compliant, surface mount modules containing all associated RF components: crystal oscillator, bypass and bias passives with integrated MAC, baseband, RF and power amplifier, and built-in hardware support for encryption. Refer to [Figure 1-1](#).

The integrated module design frees the designer from RF and antenna design tasks and regulatory compliance testing, ultimately providing faster time to market.

RN1810 incorporates an on-board TCP/IP networking stack, cryptographic accelerator, power management subsystem, real-time clock, 2.4 GHz transceiver, and RF power amplifier. With the module, designers can embed Wi-Fi and networking functionality rapidly into virtually any device.

The RN1810 provides cost and time-to-market savings as a self-contained Internet-enabling solution. The module has been designed to provide designers with a simple Wi-Fi solution that features:

- Ease of integration and programming
- Vastly reduced development time
- Minimum system cost
- Long battery life
- Maximum value in a range of applications

The RN1810 is configured with a simple ASCII command language.

In the simplest configuration, the module requires only power, ground and UART TX and RX connections. The RN1810 module can interface to low-cost microcontrollers using only two wires, UART TX and RX.

The RN1810 can independently maintain a low-power wireless network connection. Ultra-low power usage and flexible power management maximize the module's lifetime in battery-operated devices. A wide operating temperature range allows use in indoor and outdoor environments (industrial temperature range).

When operating in Sleep mode, the module minimizes battery usage while still being able to respond to certain events, including internal timers and WAKEUP signal. Applications that make efficient use of the Sleep state can extend battery life to multiple years.

The RN1810 module is approved for use with the integrated PCB trace antenna. The RN1810E module is approved for use with specific external antenna types that are certified with the module. An ultra-small coaxial connector (W.FL) is provided on the module for connection to the external antenna. Refer to [Section 3.3, "External Antenna Types"](#) for a listing of approved antenna types.

The RN1810/RN1810E modules received the regulatory approvals for modular devices in the United States (FCC) and Canada (IC). Modular approval removes the need for expensive RF and antenna design, and enables the end user to place the RN1810/RN1810E modules inside a finished product without requiring a regulatory testing for an intentional radiator (RF transmitter).

The RN1810/RN1810E module is an R&TTE Directive assessed radio module for operation in Europe. The module tests can be applied toward final product certification and Declaration of Conformity (DoC).

[Table 1-1](#) lists the RN1810 module's family types.

TABLE 1-1: RN1810 FAMILY TYPES

Device	Antenna
RN1810	Integral
RN1810E	External

RN1810/RN1810E

FIGURE 1-1: RN1810/RN1810E BLOCK DIAGRAM

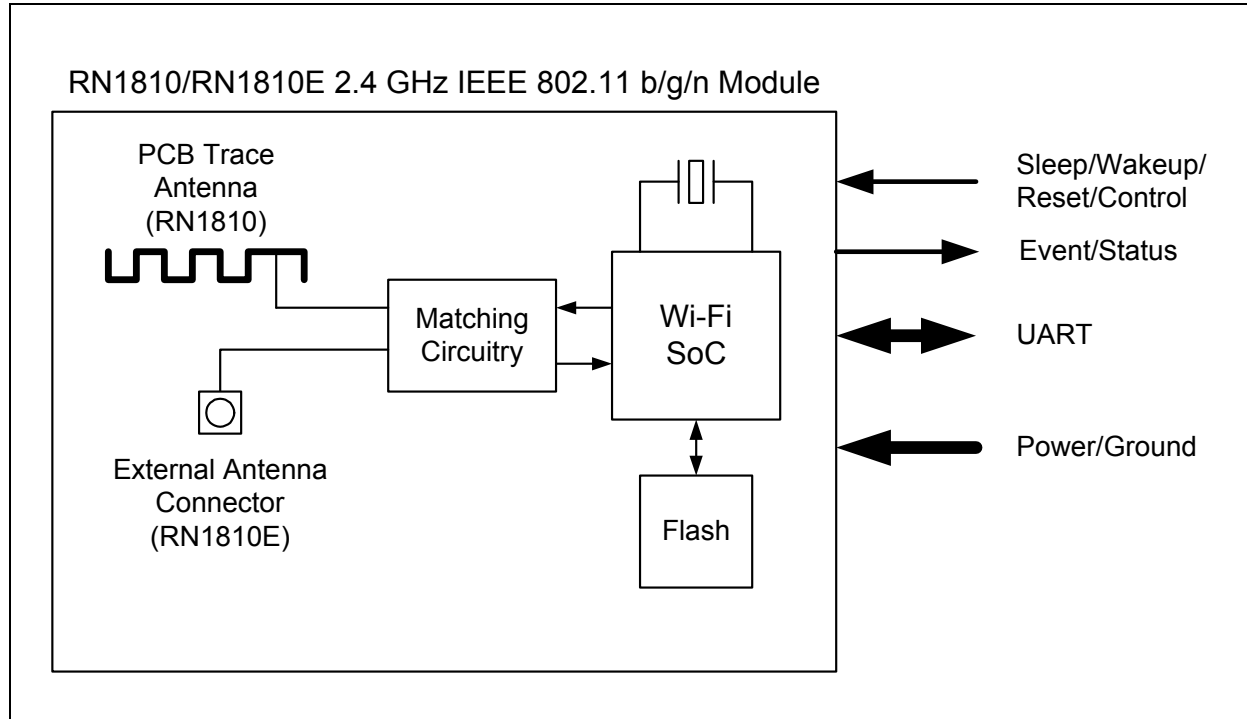

1.1 Interface Description

Figure 1-2 shows the RN1810/RN1810E pin diagram. Table 1-2 describes the RN1810/RN1810E pins.

FIGURE 1-2: RN1810/RN1810E PIN DIAGRAM

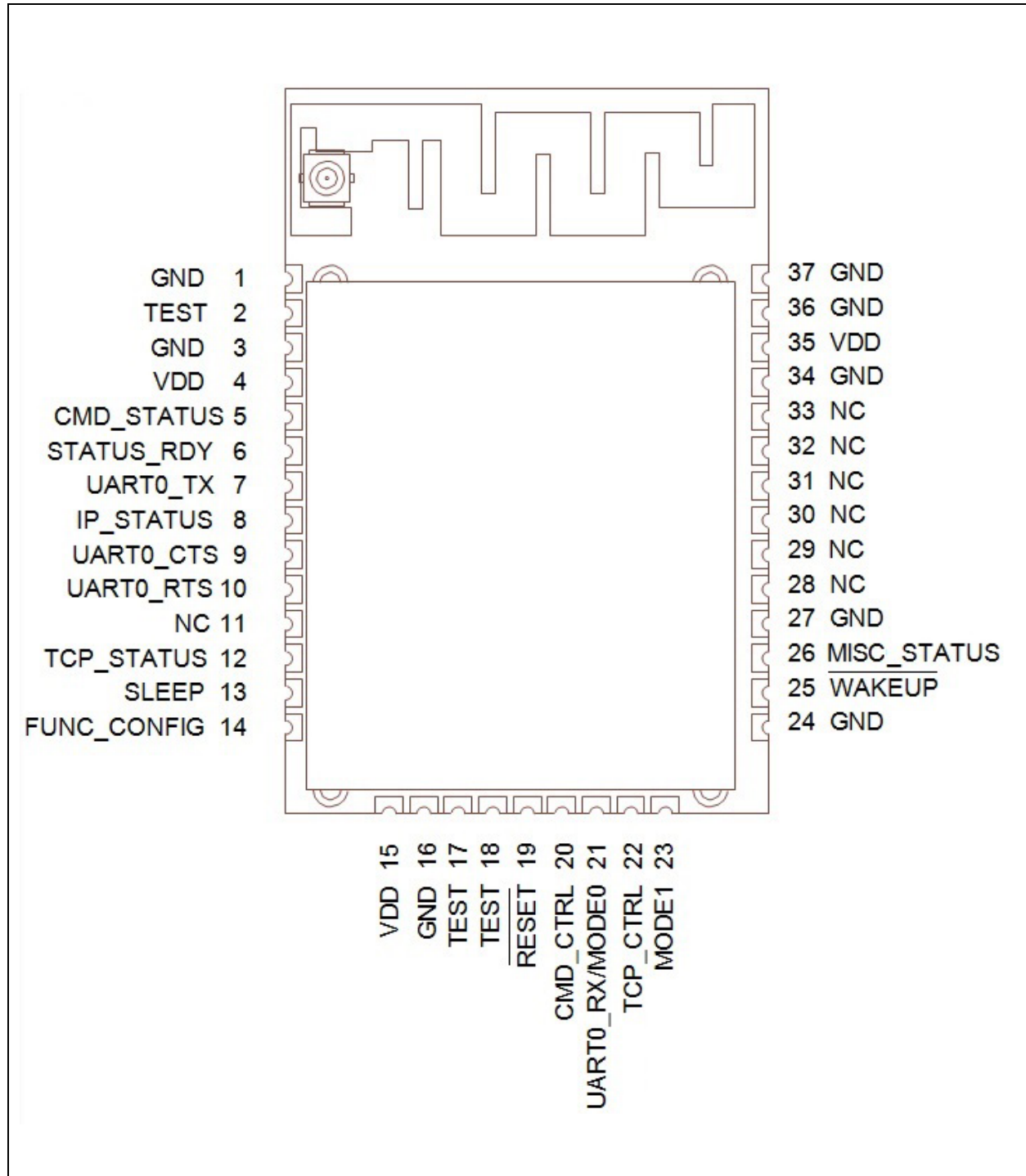

RN1810/RN1810E

TABLE 1-2: PIN DESCRIPTIONS

Pin	Name	Type	Description ⁽¹⁾
1	GND	Power	—
2	TEST	Test	Do not connect
3	GND	Power	—
4	VDD	Power	—
5	CMD_STATUS	DO	This is an optional IO that signals operational status.
6	STATUS_RDY	DO	This is an optional IO that signals WiFly is ready to accept commands.
7	UART0_TX	DO	Host interface UART0 TX
8	IP_STATUS	DO	This is an optional IO that signals WiFly has connected to an AP and received an IP address.
9	UART0_CTS	DI	UART0 CTS
10	UART0_RTS	DO	UART0 RTS
11	NC	Reserved	Do not connect
12	TCP_STATUS	DO	This an optional IO that signals a successful TCP connection or FTP transfer.
13	SLEEP	DI	This is an optional IO that puts the RN1810 into Sleep state.
14	FUNC_CONFIG	DI	This is an optional IO that starts various applications and resets configurations to factory defaults.
15	VDD	Power	—
16	GND	Power	—
17	TEST	Test	Do not connect
18	TEST	Test	Do not connect
19	RESET	DI	Resets RN1810
20	CMD_CTRL	DI	This is an optional IO that switches RN1810 modes.
21	UART0_RX/ MODE0	DI	Host interface UART0 RX/Mode select 0; connect to VDD via 100 kΩ pull-up resistor ⁽²⁾
22	TCP_CTRL	DI	This is an optional IO that opens or closes a TCP connection, or handshakes FTP transfers.
23	MODE1	DI	Mode select 1; connect to GND ⁽²⁾
24	GND	Power	—
25	WAKEUP	DI	This is an optional IO that awakens the RN1810 from Sleep mode.
26	MISC_STATUS	DO	This is an optional IO that signals miscellaneous application status.
27	GND	Power	—
28	NC	Reserved	Do not connect
29	NC	Reserved	Do not connect
30	NC	Reserved	Do not connect
31	NC	Reserved	Do not connect
32	NC	Reserved	Do not connect
33	NC	Reserved	Do not connect
34	GND	Power	—
35	VDD	Power	—
36	GND	Power	—
37	GND	Power	—

Legend: A = Analog, D = Digital, I = Input, O = Output

Note 1: For NC = No Connect pins, do not make any connection. The module is configured with internal pull-up and pull-down resistors.

2: Refer to [Section 2.2, "MODE0 and MODE1 Pins"](#).

1.2 Mounting Details

Figure 1-3, Figure 1-4 and Figure 1-5 show the physical dimensions and the mounting details of the module. Figure 1-6 and Figure 1-7 show the recommended host PCB footprint and layout.

FIGURE 1-3: RN1810/RN1810E MODULE PHYSICAL DIMENSIONS (TOP AND SIDE VIEW)

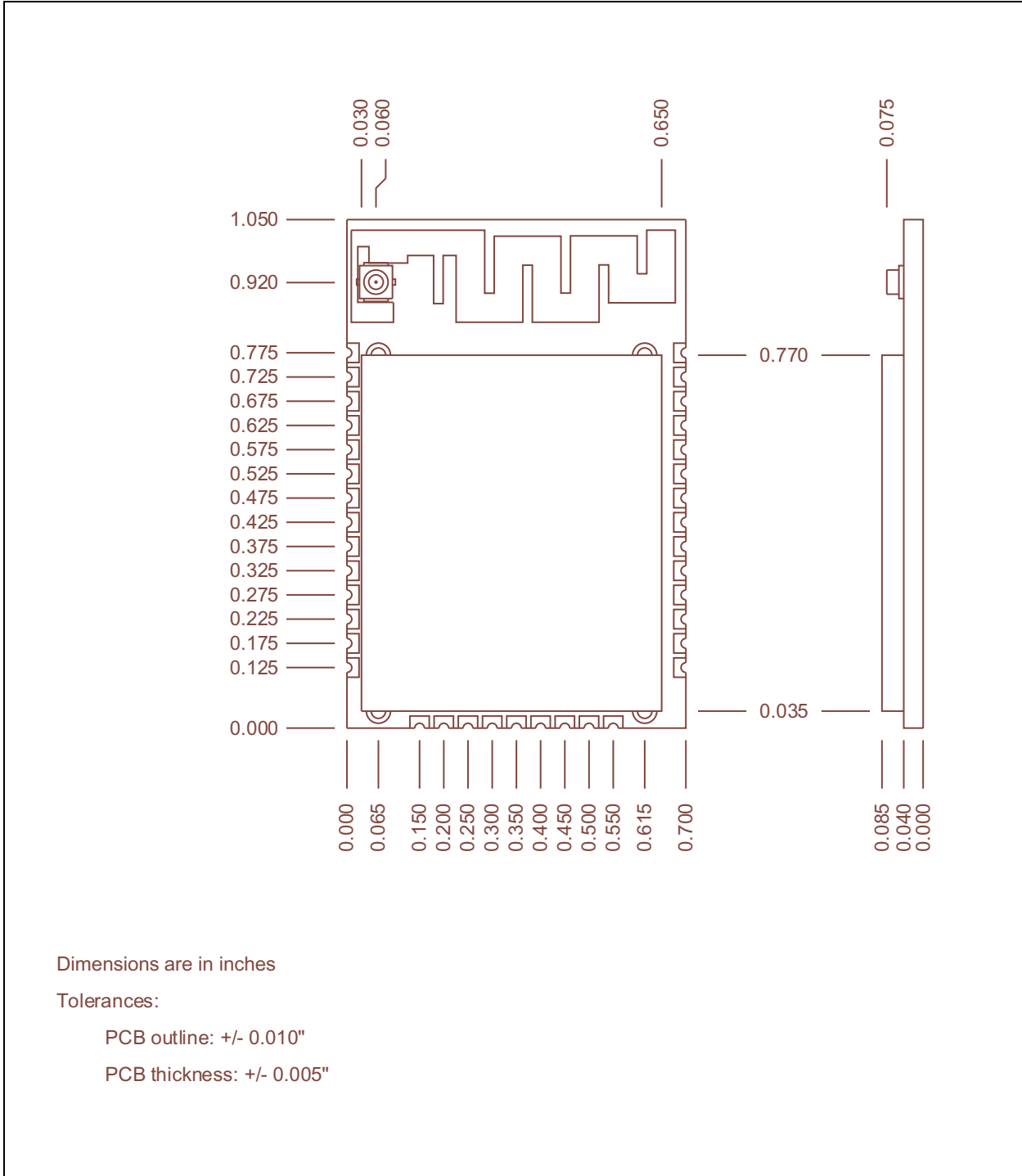

RN1810/RN1810E

FIGURE 1-4: RN1810/RN1810E MODULE PHYSICAL DIMENSIONS (BOTTOM VIEW)

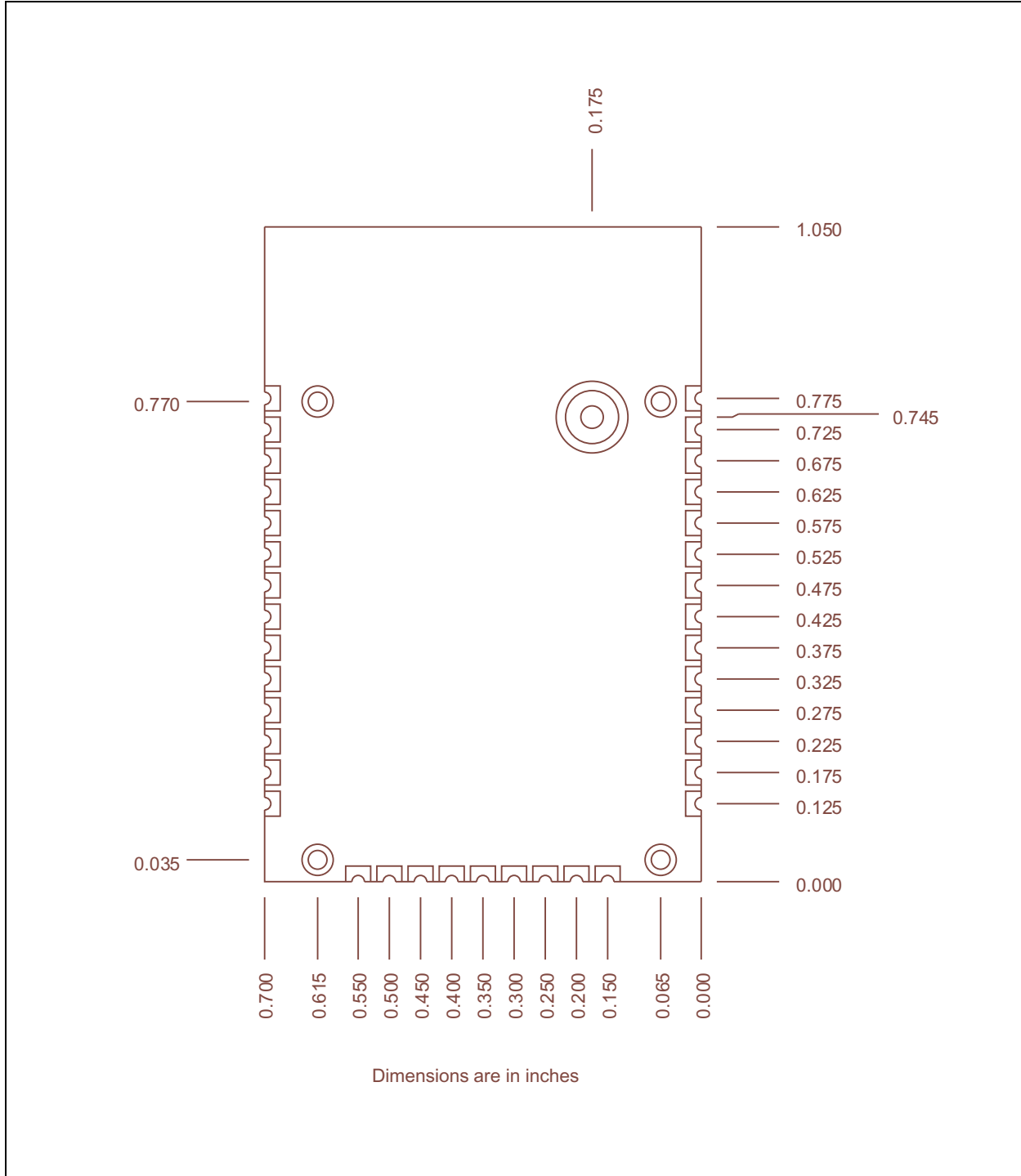
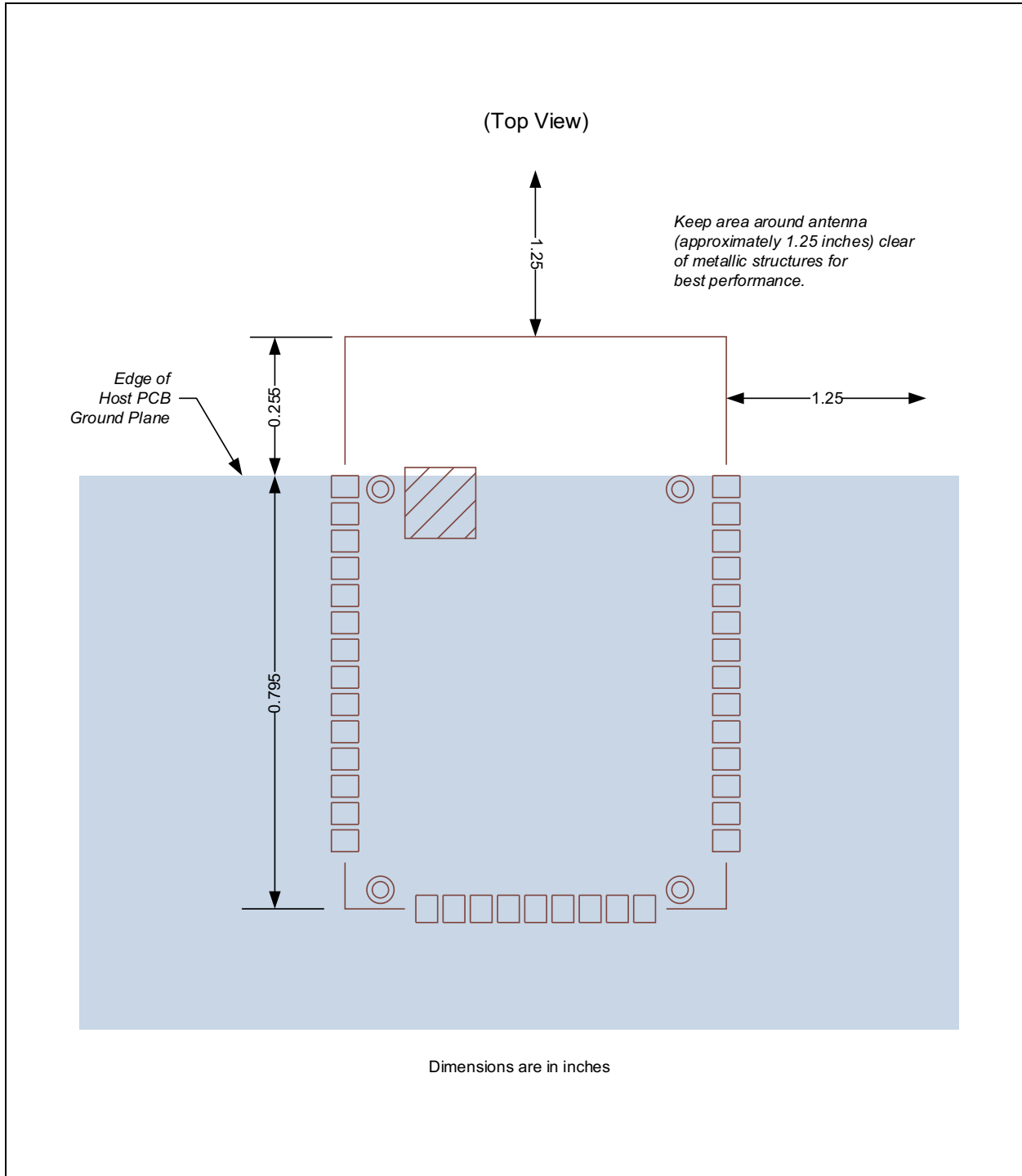

FIGURE 1-5: RN1810/RN1810E MODULE MOUNTING DETAILS



RN1810/RN1810E

FIGURE 1-6: RN1810/RN1810E RECOMMENDED HOST PCB FOOTPRINT

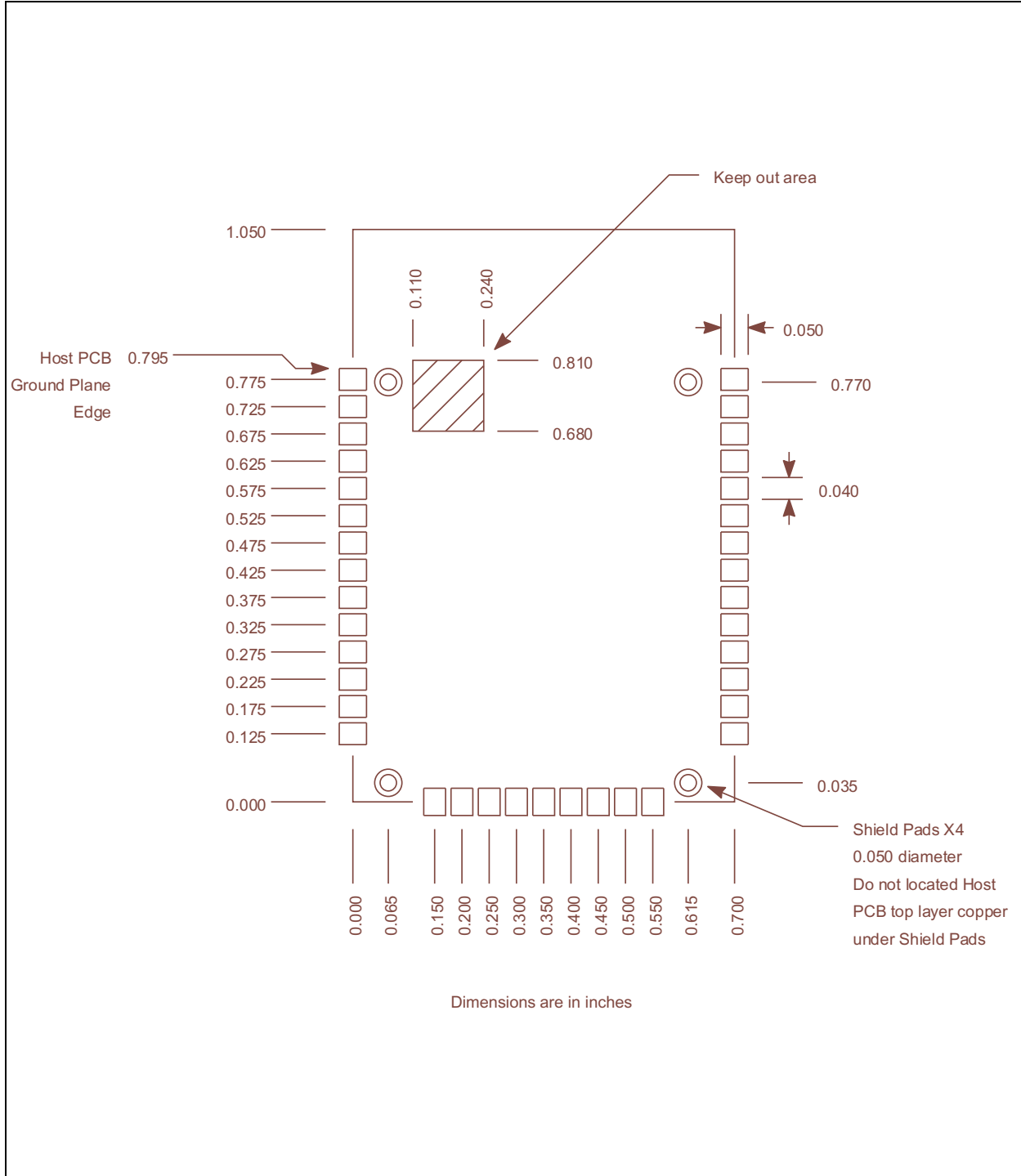
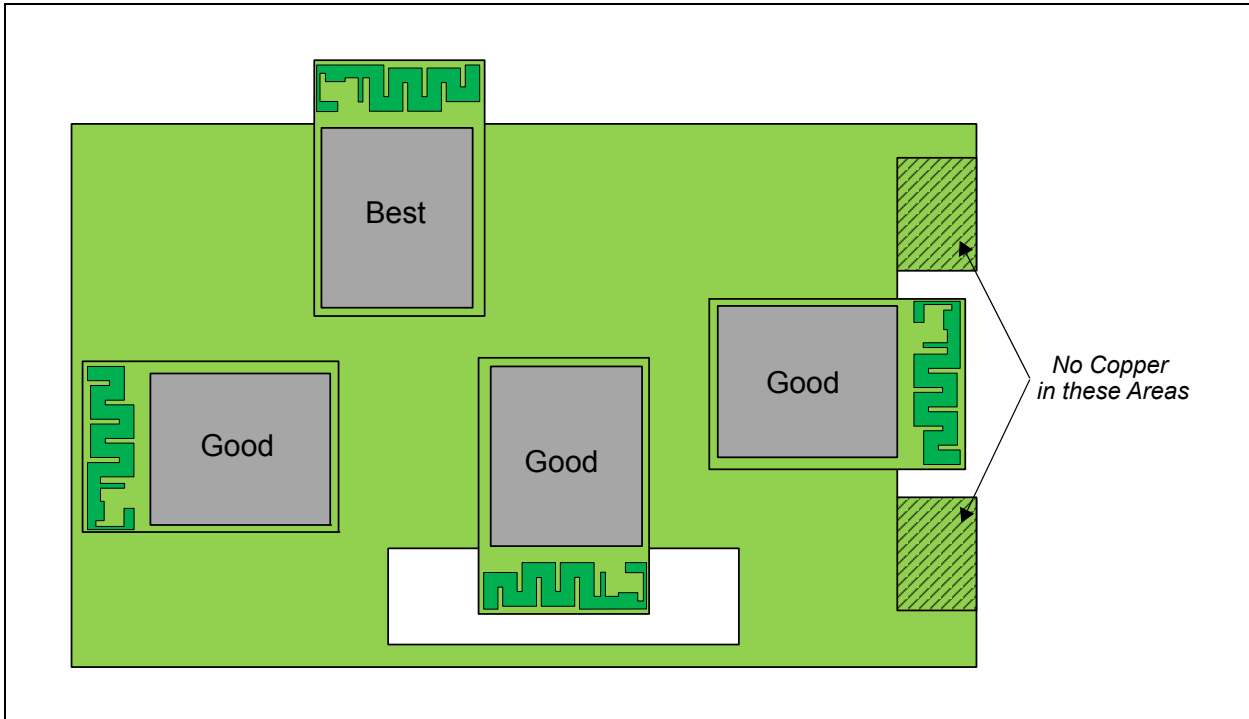

FIGURE 1-7: RN1810/RN1810E HOST PCB EXAMPLE LAYOUT



1.3 Soldering Recommendations

The RN1810/RN1810E wireless module is assembled using the IPC/JEDEC J-STD-020 Standard lead-free reflow profile. The RN1810/RN1810E module can be soldered to the host PCB using standard leaded and lead-free solder reflow profiles.

To avoid damaging the module, adhere to the following recommendations:

- Solder reflow recommendations are provided in the Microchip Application Note, AN233 "Solder Reflow Recommendation" (DS00233)
- Do not exceed a peak temperature (Tp) of 250°C
- Refer to the solder paste data sheet for specific reflow profile recommendations from the vendor
- Use no-clean flux solder paste
- Do not wash as moisture can be trapped under the shield
- Use only one flow. If the PCB requires multiple flows, apply the module on the final flow.

RN1810/RN1810E

NOTES:

2.0 CIRCUIT DESCRIPTION

levels are CMOS voltage levels (not RS-232 voltage levels). The UART interface supports baud rates of 9,600, 19,200, 38,400, 57,600 and 115,200 bits per second.

2.1 UART Interface

The UART interface supports 2-wire (RX, TX) and 4-wire configurations with hardware flow control (RX, TX, CTS, and RTS) as illustrated in Figure 2-1. The logic

FIGURE 2-1: HOST MCU TO RN1810/RN1810E BLOCK DIAGRAM

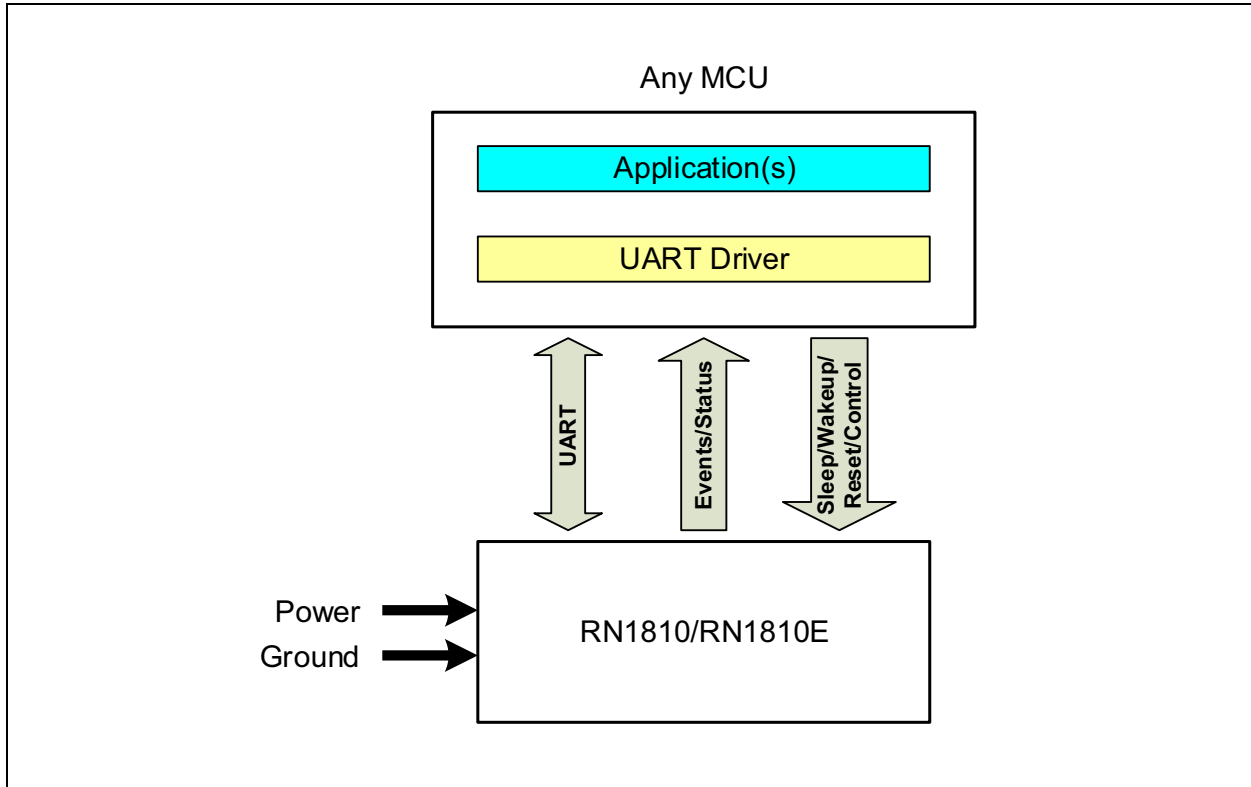
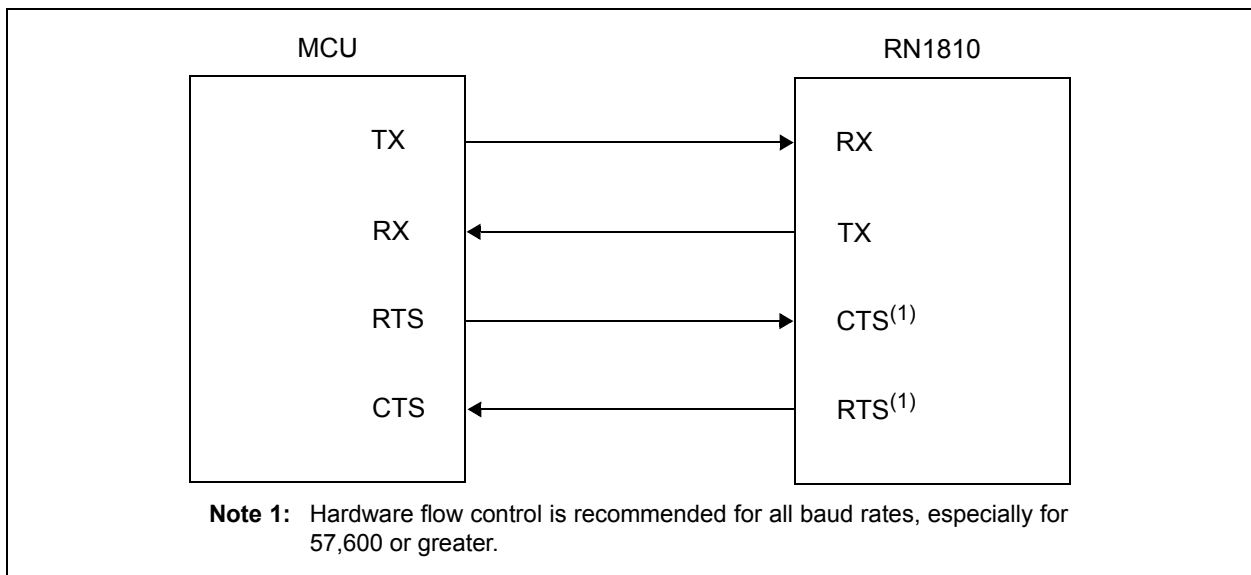

FIGURE 2-2: MCU TO RN1810 INTERFACE



RN1810/RN1810E

2.2 MODE0 and MODE1 Pins

The MODE pins must be tied to the voltage levels for normal operation of the module. Refer to [Table 2-1](#).

TABLE 2-1: MODE PIN OPERATION

Pin	Condition
MODE1	Connect to GND
UART0_RX/MODE0	Connect to VDD via 100 kΩ pull-up resistor

The MODE pins are sampled at power on and wake-up. Refer to [Section 2.4, "Sleep and Wakeup"](#). In the case of UART0_RX/MODE0 pin, a 100 kΩ pull-up resistor is required, and the host MCU allows an active-high signal during power on and wake-up to ensure that the module start-up in normal operation. Once the module is operational, the pin becomes the UART0_RX pin.

2.3 VDD and GND Pin

The RN1810/RN1810E wireless module contains an integrated power management unit that generates all necessary voltages required by the internal circuitry. The module is powered from a single voltage source.

[Table 2-2](#) lists the recommended bypass capacitors. The capacitors must be closely placed to the module.

TABLE 2-2: RECOMMENDED BYPASS CAPACITORS

Pin	Symbol	Bypass Capacitors
4	VDD	0.1 μF and 2.2 μF
15	VDD	0.1 μF and 2.2 μF
35	VDD	0.1 μF and 2.2 μF

2.4 Sleep and Wakeup

The module enters the lowest power mode when the SLEEP pin is asserted high. WLAN and network connection information is preserved.

The module can wake-up when $\overline{\text{WAKEUP}}$ pin is asserted low. The module restores the saved information after wakeup.

2.5 Module Reset

There are several ways to Reset the module:

- A Power-On Reset is automatically generated when power is applied. This Reset is intended to initialize the module when a new battery is connected.
- Perform an external Power-On Reset by asserting the $\overline{\text{RESET}}$ pin low.
- Perform a soft Power-On Reset using software commands

The $\overline{\text{RESET}}$ pulse duration must be a minimum of 650 ns.

2.6 Factory Reset

The Factory Reset is intended to initialize provisioning information stored in flash memory by asserting FUNC_CONFIG Low to High five times with 300 ms between transitions.

RN1810/RN1810E

3.2 Integral PCB Trace Antenna

For the RN1810, the PCB antenna is fabricated on the top copper layer and covered in solder mask. The layers below the antenna do not have copper trace.

It is recommended that the module is mounted on the edge of the host PCB. It is permitted for PCB material to be below the antenna structure of the module as long as no copper traces or planes are on the host PCB in that area. For best performance, place the module on the host PCB according to the details shown in Figure 1-7.

The antenna patterns plotted in Figure 3-2 through Figure 3-5 are the simulated results of the PCB antenna.

Figure 3-2 illustrates the simulation drawing. The two-dimensional (2D) radiation pattern is illustrated in Figure 3-3, whereas Figure 3-4 and Figure 3-5 show the three-dimensional (3D) radiation patterns.

The calculated average of the radiated field is shown in Figure 3-3. The radiation pattern for the XZ plane is shown in red, whereas the YZ plane is shown in violet. The most powerful radiation occurs in the XZ plane as represented by the red pattern.

Figure 3-4 shows the relative position of the 3D radiation “donut” with reference to the module orientation. This is a very useful guide for placement of the module to obtain the maximum range.

Figure 3-5 shows the 3D radiation pattern with the colored distribution of the radiation magnitude. The values range from -9 dB to +0.3 dB. This is very useful in interpreting the 2D radiation pattern.

FIGURE 3-2: PCB ANTENNA SIMULATION DRAWING

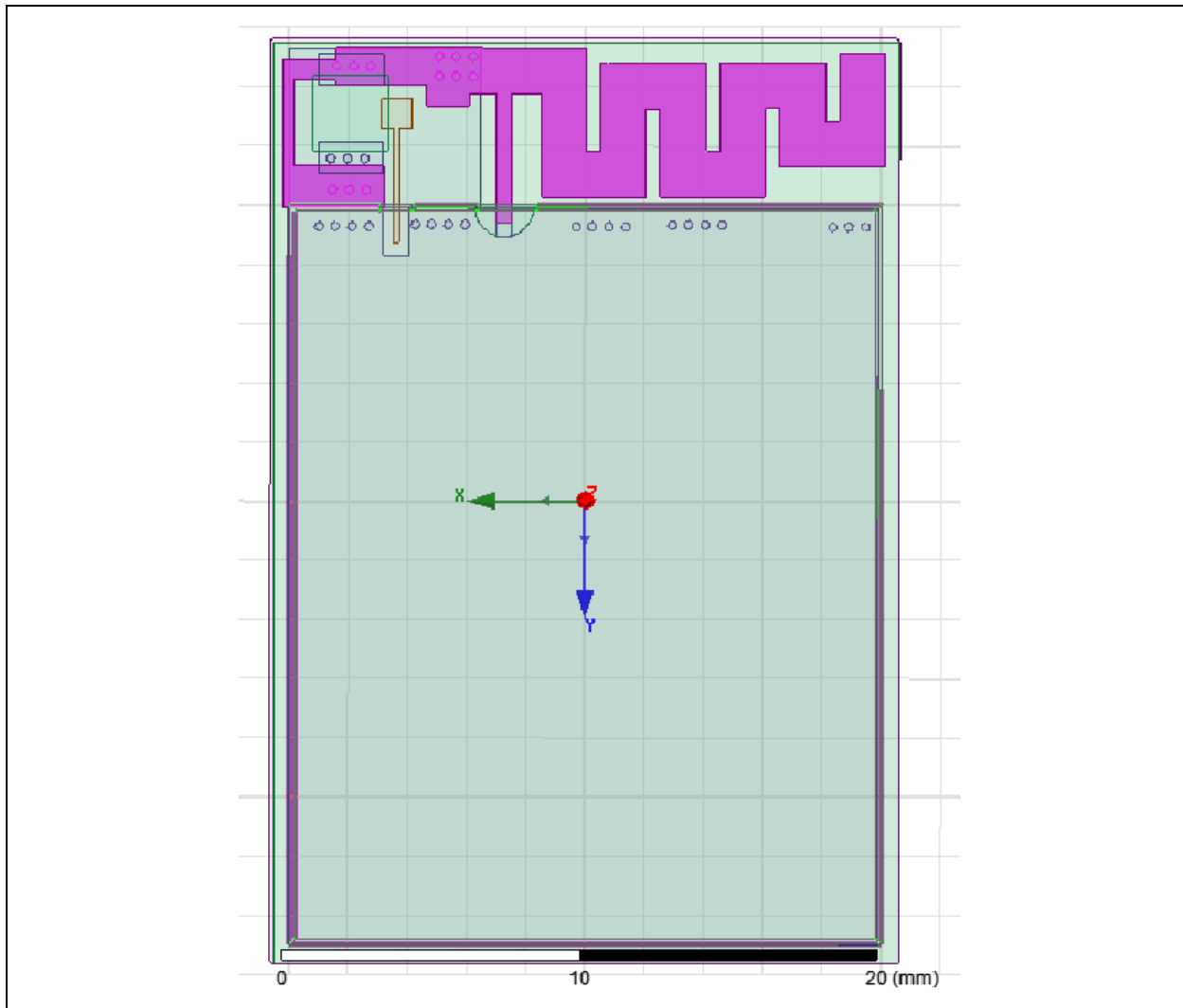
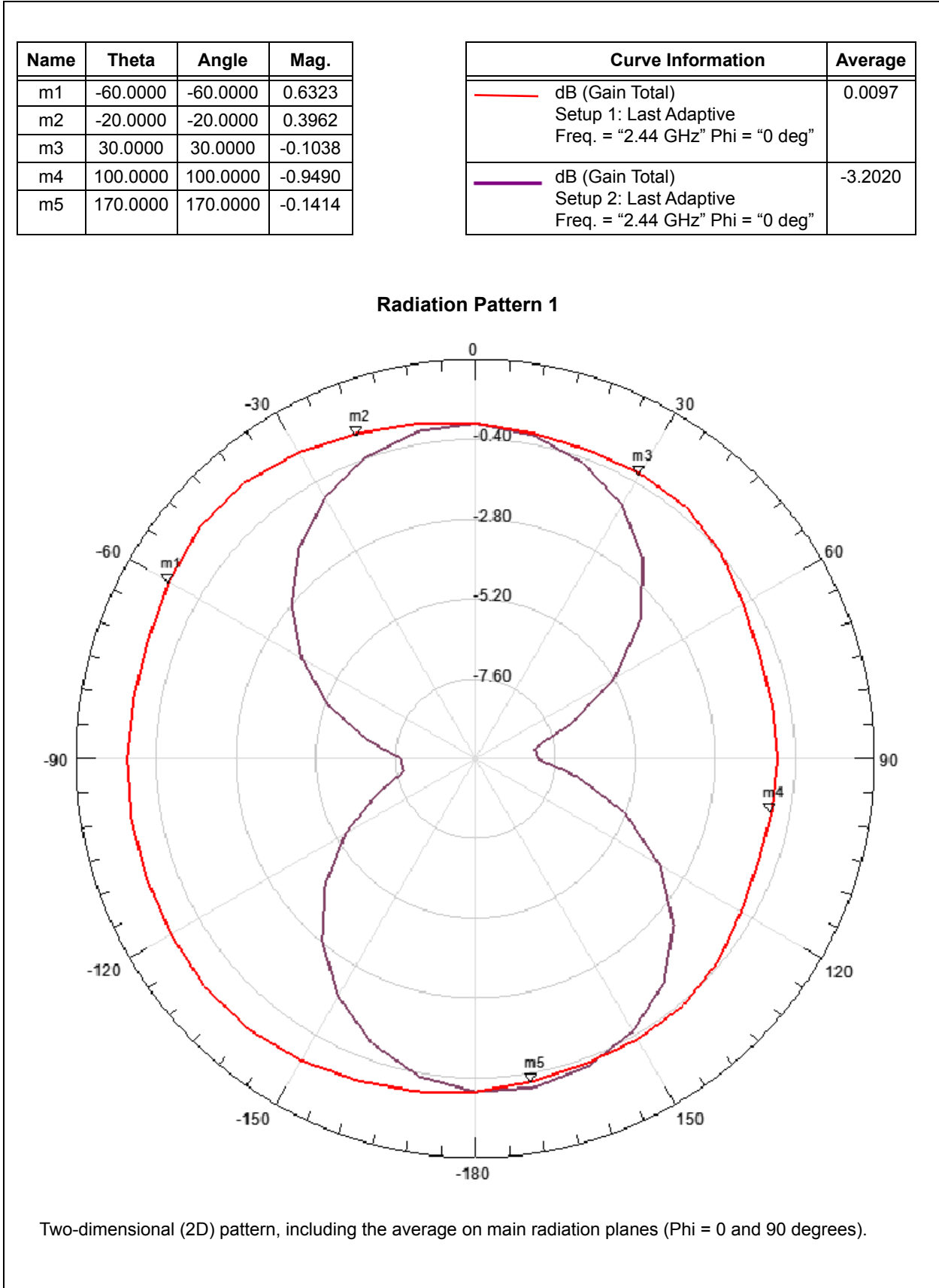

FIGURE 3-3: SIMULATED TWO-DIMENSIONAL RADIATION PATTERN



RN1810/RN1810E

FIGURE 3-4: SIMULATED THREE-DIMENSIONAL RADIATION PATTERN

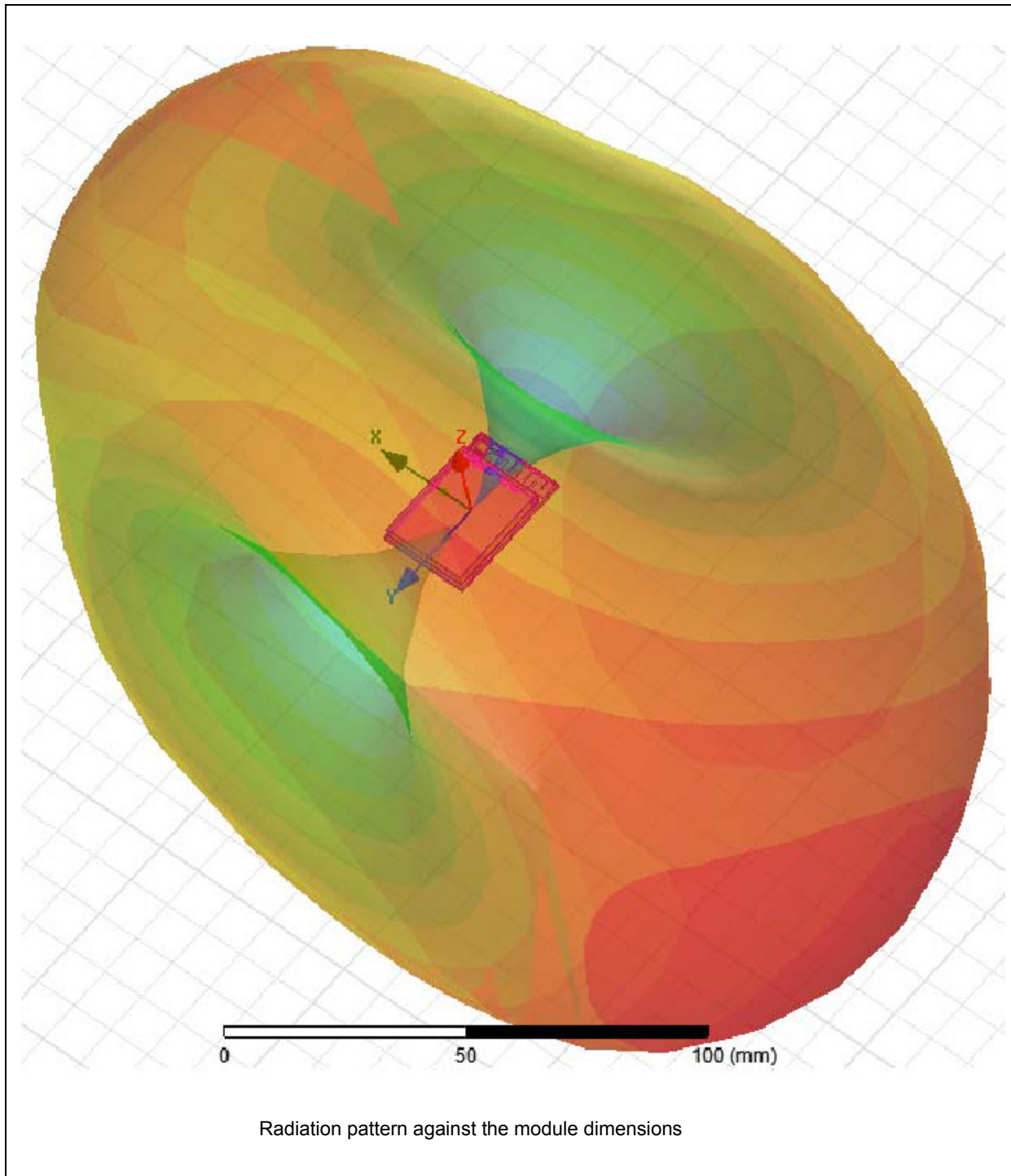
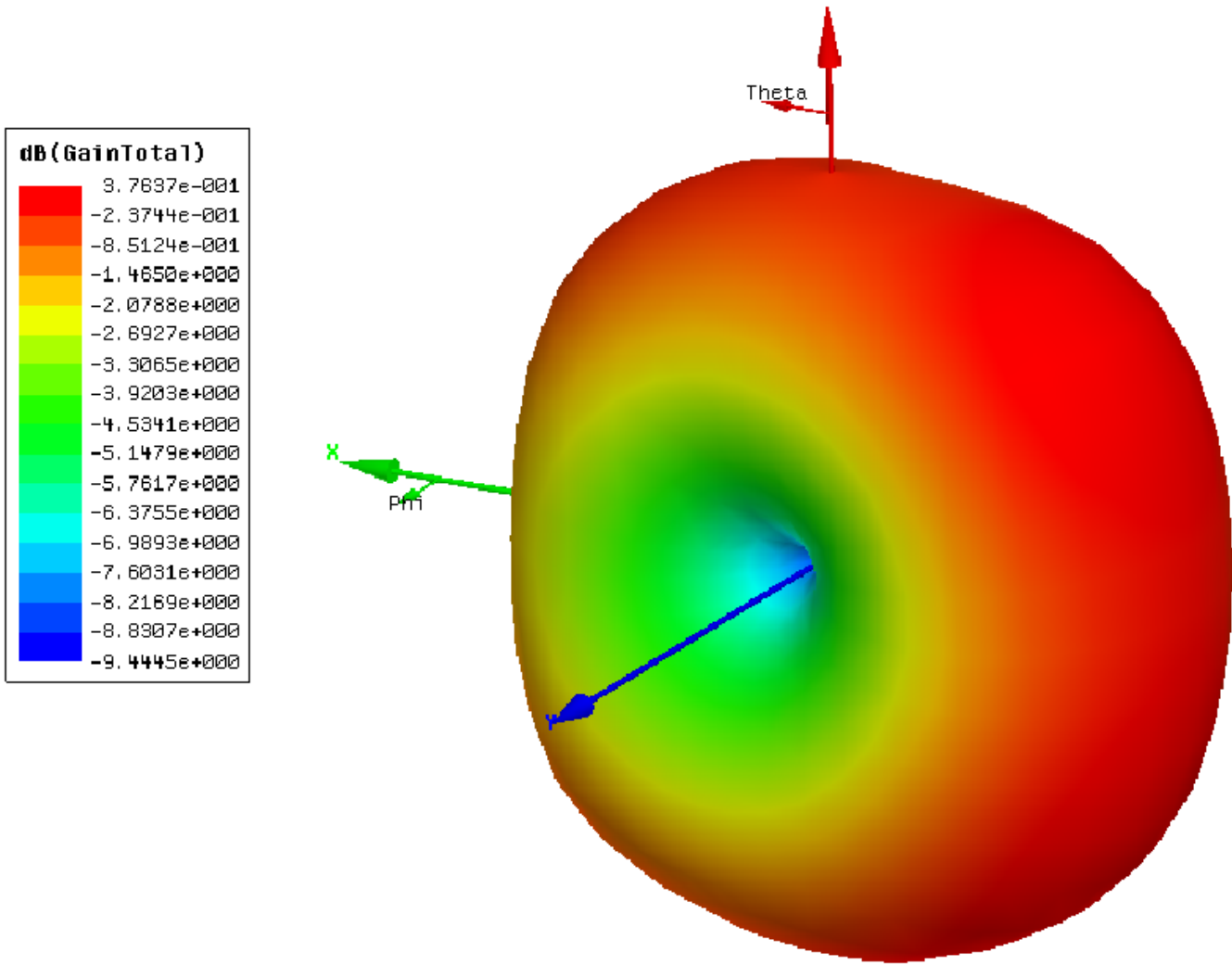

FIGURE 3-5: SIMULATED THREE-DIMENSIONAL RADIATION PATTERN



Three-dimensional (3D) pattern and magnitude distribution

RN1810/RN1810E

3.3 External Antenna Types

The RN1810E module has an ultra-small coaxial connector (W.FL) for connection to the external antenna.

The choice of antenna is limited to the antenna types in which the module is tested and approved. For a list of tested and approved antenna types that may be used with the module, refer to the respective country in [Section 4.0, "Regulatory Approval"](#).

[Table 3-1](#) lists the approved antennas types.

TABLE 3-1: TESTED EXTERNAL ANTENNA TYPES

Type	Gain
PCB Trace	1 dBi
Dipole	2 dBi
PIFA	-3 dBi

4.0 REGULATORY APPROVAL

This section outlines the regulatory information for the RN1810/RN1810E module for the following countries:

- United States
- Canada
- Europe
- Australia
- New Zealand
- Japan
- Korea
- Taiwan
- Other Regulatory Jurisdictions

4.1 United States

The RN1810/RN1810E module has received Federal Communications Commission (FCC) CFR47 Telecommunications, Part 15 Subpart C “Intentional Radiators” single-modular approval in accordance with Part 15.212 Modular Transmitter approval. Single-modular transmitter approval is defined as a complete RF transmission sub-assembly, designed to be incorporated into another device, that must demonstrate compliance with FCC rules and policies independent of any host. A transmitter with a modular grant can be installed in different end-use products (referred to as a host, host product, or host device) by the grantee or other equipment manufacturer, then the host product may not require additional testing or equipment authorization for the transmitter function provided by that specific module or limited module device.

A host product itself is required to comply with all other applicable FCC equipment authorization regulations, requirements, and equipment functions that are not associated with the transmitter module portion. For example, compliance must be demonstrated: to regulations for other transmitter components within a host product; to requirements for unintentional radiators (Part 15 Subpart B), such as digital devices, computer peripherals, radio receivers, etc.; and to additional authorization requirements for the non-transmitter functions on the transmitter module (i.e., Verification or Declaration of Conformity) as appropriate (e.g., Bluetooth and Wi-Fi transmitter modules may also contain digital logic functions).

4.1.1 LABELING AND USER INFORMATION REQUIREMENTS

The RN1810/RN1810E module has been labeled with its own FCC ID number, and if the FCC ID is not visible when the module is installed inside another device, then the outside of the finished product into which the module is installed must also display a label referring to the enclosed module. This exterior label can use wording as follows:

Contains Transmitter Module FCC ID: W7O24WN0

or

Contains FCC ID: W7O24WN0

This device complies with Part 15 of the FCC Rules. Operation is subject to the following two conditions: (1) this device may not cause harmful interference, and (2) this device must accept any interference received, including interference that may cause undesired operation.

A user’s manual for the product should include the following statement:

This equipment has been tested and found to comply with the limits for a Class B digital device, pursuant to part 15 of the FCC Rules. These limits are designed to provide reasonable protection against harmful interference in a residential installation. This equipment generates, uses and can radiate radio frequency energy, and if not installed and used in accordance with the instructions, may cause harmful interference to radio communications. However, there is no guarantee that interference will not occur in a particular installation. If this equipment does cause harmful interference to radio or television reception, which can be determined by turning the equipment off and on, the user is encouraged to try to correct the interference by one or more of the following measures:

- Reorient or relocate the receiving antenna.
- Increase the separation between the equipment and receiver.
- Connect the equipment into an outlet on a circuit different from that to which the receiver is connected.
- Consult the dealer or an experienced radio/TV technician for help.

Additional information on labeling and user information requirements for Part 15 devices can be found in KDB Publication 784748 available at the FCC Office of Engineering and Technology (OET) Laboratory Division Knowledge Database (KDB)

<http://apps.fcc.gov/oetcf/kdb/index.cfm>

RN1810/RN1810E

4.1.2 RF EXPOSURE

All transmitters regulated by FCC must comply with RF exposure requirements. KDB Publication 447498 General RF Exposure Guidance provides guidance in determining whether proposed or existing transmitting facilities, operations or devices comply with limits for human exposure to Radio Frequency (RF) fields adopted by the Federal Communications Commission (FCC).

This module is approved for installation into mobile and/or portable host platforms and must not be co-located or operating in conjunction with any other antenna or transmitter except in accordance with FCC multitransmitter guidelines. End users must be provided with transmitter operating conditions for satisfying RF Exposure compliance.

4.1.3 APPROVED EXTERNAL ANTENNA TYPES

To maintain modular approval in the United States, only the antenna types that have been tested shall be used. It is permissible to use different antenna manufacturer provided the same antenna type and antenna gain (equal to or less than) is used. An antenna type comprises antennas having similar in-band and out-of-band radiation patterns.

Testing of the RN1810/RN1810E module was performed with the antenna types listed in [Table 3-1](#).

4.1.4 HELPFUL WEB SITES

Federal Communications Commission (FCC):
<http://www.fcc.gov>

FCC Office of Engineering and Technology (OET) Laboratory Division Knowledge Database (KDB):
<http://apps.fcc.gov/oetcf/kdb/index.cfm>

4.2 Canada

The RN1810/RN1810E module has been certified for use in Canada under Industry Canada (IC) Radio Standards Procedure (RSP) RSP-100, Radio Standards Specification (RSS) RSS-Gen, RSS-210, and RSS-247. Modular approval permits the installation of a module in a host device without the need to recertify the device.

4.2.1 LABELING AND USER INFORMATION REQUIREMENTS

Labeling Requirements (from RSP-100 - Issue 10, Section 3): The host device shall be properly labeled to identify the module within the host device.

Modular Devices (from RSP-100 - Issue 10, Section 7): The Industry Canada certification label of a module shall be clearly visible at all times when installed in the host device, otherwise the host device must be labeled to display the Industry Canada certification number of

the module, preceded by the words "Contains transmitter module", or the word "Contains", or similar wording expressing the same meaning, as follows:

Contains transmitter module IC: 7693A-24WN0

User Manual Notice for License-Exempt Radio Apparatus (from Section 8.4, RSS-Gen, Issue 4, November 2014): User manuals for license-exempt radio apparatus shall contain the following or equivalent notice in a conspicuous location in the user manual or alternatively on the device or both:

This device complies with Industry Canada's license-exempt RSSs. Operation is subject to the following two conditions:

- (1) This device may not cause interference; and
- (2) This device must accept any interference, including interference that may cause undesired operation of the device.

Le présent appareil est conforme aux CNR d'Industrie Canada applicables aux appareils radio exempts de licence. L'exploitation est autorisée aux deux conditions suivantes:

- (1) l'appareil ne doit pas produire de brouillage;
- (2) l'utilisateur de l'appareil doit accepter tout brouillage radioélectrique subi, même si le brouillage est susceptible d'en compromettre le fonctionnement.

4.2.2 RF EXPOSURE

All transmitters regulated by IC must comply with RF exposure requirements listed in RSS-102 - Radio Frequency (RF) Exposure Compliance of Radiocommunication Apparatus (All Frequency Bands).

This module is approved for installation into mobile and/or portable host platforms and must not be co-located or operating in conjunction with any other antenna or transmitter except in accordance with Industry Canada's multi-transmitter guidelines. End users must be provided with transmitter operating conditions for satisfying RF Exposure compliance.

4.2.3 APPROVED EXTERNAL ANTENNA TYPES

Transmitter Antenna for License-Exempt Radio Apparatus (from Section 8.3 RSS-Gen, Issue 4, November 2014):

The RN1810/RN1810E module can only be sold or operated with the antenna types with which it was approved. It is permissible to use different antenna manufacturer provided the same antenna type and antenna gain (equal to or less than) is used. An antenna type comprises antennas having similar in-band and out-of-band radiation patterns.

Approved external antenna types for the RN1810/RN1810E module are listed in [Table 3-1](#).

User manuals for transmitters equipped with detachable antennas shall also contain the following notice in a conspicuous location:

This radio transmitter (identify the device by certification number) has been approved by Industry Canada to operate with the antenna types listed below with the maximum permissible gain indicated. Antenna types not included in this list, having a gain greater than the maximum gain indicated for that type, are strictly prohibited for use with this device.

Le présent émetteur radio (identifier le dispositif par son numéro de certification) a été approuvé par Industrie Canada pour fonctionner avec les types d'antenne énumérés ci-dessous et ayant un gain admissible maximal. Les types d'antenne non inclus dans cette liste, et dont le gain est supérieur au gain maximal indiqué, sont strictement interdits pour l'exploitation de l'émetteur.

Immediately following the above notice, the manufacturer shall provide a list of all antenna types approved for use with the transmitter, indicating the maximum permissible antenna gain (in dBi).

4.2.4 HELPFUL WEB SITES

Industry Canada: <http://www.ic.gc.ca/>

4.3 Europe

The RN1810/RN1810E module is an R&TTE Directive assessed radio module that is CE marked and has been manufactured and tested with the intention of being integrated into a final product.

The RN1810/RN1810E module has been tested to R&TTE Directive 1999/5/EC Essential Requirements for Health and Safety (Article (3.1(a)), Electromagnetic Compatibility (EMC) (Article 3.1(b)), and Radio (Article 3.2) and are summarized in [Table 4-1 European Compliance Testing](#) European Compliance Testing. A Notified Body Opinion has also been issued. All test reports are available on the RN1810/RN1810E product web page at <http://www.microchip.com>.

The R&TTE Compliance Association provides guidance on modular devices in document **Technical Guidance Note 01** available at http://www.rteca.com/html/download_area.htm.

Note: To maintain conformance to the testing listed in [Table 4-1 European Compliance Testing](#), the module shall be installed in accordance with the installation instructions in this data sheet and shall not be modified.

When integrating a radio module into a completed product the integrator becomes the manufacturer of the final product and is therefore responsible for demonstrating compliance of the final product with the essential requirements of the R&TTE Directive.

4.3.1 LABELING AND USER INFORMATION REQUIREMENTS

The label on the final product which contains the RN1810/RN1810E module must follow CE marking requirements. The R&TTE Compliance Association **Technical Guidance Note 01** provides guidance on final product CE marking.

4.3.2 EXTERNAL ANTENNA REQUIREMENTS

From R&TTE Compliance Association document **Technical Guidance Note 01**:

Provided the integrator installing an assessed radio module with an integral or specific antenna and installed in conformance with the radio module manufacturer's installation instructions requires no further evaluation under Article 3.2 of the R&TTE Directive and does not require further involvement of an R&TTE Directive Notified Body for the final product. [Section 2.2.4]]

The European Compliance Testing listed in [Table 4-1](#) was performed using the antenna types listed in [Table 3-1](#).

4.3.3 HELPFUL WEB SITES

A document that can be used as a starting point in understanding the use of Short Range Devices (SRD) in Europe is the European Radio Communications Committee (ERC) Recommendation 70-03 E, which can be downloaded from the European Radio Communications Office (ERO) at: <http://www.ero.dk/>.

RN1810/RN1810E

Additional helpful web sites are:

- Radio and Telecommunications Terminal Equipment (R&TTE):
http://ec.europa.eu/enterprise/rtte/index_en.htm
- European Conference of Postal and Telecommunications Administrations (CEPT):
<http://www.cept.org/>

- European Telecommunications Standards Institute (ETSI):
<http://www.etsi.org>
- European Radio Communications Office (ERO):
<http://www.ero.dk/>
- The Radio and Telecommunications Terminal Equipment Compliance Association (R&TTE CA):
<http://www.rteca.com/>

TABLE 4-1: EUROPEAN COMPLIANCE TESTING

Certification	Standards	Article	Laboratory	Report Number	Date
Safety	EN 60950-1:2006+A11:2009+A1:2010 +A12:2011	(3.1(a))		Pending	
Health	EN 62479:2010			Pending	
EMC	EN 301 489-1 V1.9.2 (2011-09)	(3.1(b))		Pending	
	EN 301 489-17 V2.2.1 (2012-09)				
Radio	EN 300 328 V1.8.1 (2006-06)	(3.2)		Pending	
Notified Body Opinion				Pending	

4.4 Australia

The Australia radio regulations do not provide a modular approval policy similar to the United States (FCC) and Canada (IC). However, RN1810/RN1810E module RF transmitter test reports can be used in part to demonstrate compliance in accordance with ACMA Radio communications “Short Range Devices” Standard 2004 (The Short Range Devices standard calls up the AS/NZS 4268:2008 industry standard). The RN1810/RN1810E module test reports can be used as part of the product certification and compliance folder. For more information on the RF transmitter test reports, contact Microchip Technology Australia sales office.

To meet overall Australian final product compliance, the developer must construct a compliance folder containing all relevant compliance test reports e.g. RF, EMC, electrical safety and DoC (Declaration of Conformity) etc. It is the responsibility of the integrator to know what is required in the compliance folder for ACMA compliance. All test reports are available on the RN1810/RN1810E product web page at <http://www.microchip.com>. For more information on Australia compliance, refer to the Australian Communications and Media Authority web site <http://www.acma.gov.au/>.

4.4.1 EXTERNAL ANTENNA REQUIREMENTS

The compliance testing listed in [Table 4-1](#) was performed using the antenna types listed in [Table 3-1](#).

4.4.2 HELPFUL WEB SITES

The Australian Communications and Media Authority: www.acma.gov.au/.

4.5 New Zealand

The New Zealand radio regulations do not provide a modular approval policy similar to the United States (FCC) and Canada (IC). However, RN1810/RN1810E module RF transmitter test reports can be used in part to demonstrate compliance against the New Zealand “General User Radio License for Short Range Devices”. New Zealand Radio communications (Radio Standards) Notice 2010 calls up the AS / NZS 4268:2008 industry standard. The RN1810/RN1810E module test reports can be used as part of the product certification and compliance folder. All test reports are available on the RN1810/RN1810E product web page at <http://www.microchip.com>. For more information on the RF transmitter test reports, contact Microchip Technology sales office.

Information on the New Zealand short range devices license can be found in the following web links:

<http://www.rsm.govt.nz/cms/licensees/types-of-licence/general-user-licences/short-range-devices>

and

<http://www.rsm.govt.nz/cms/policy-and-planning/spectrum-policy-overview/legislation/gazette-notices/product-compliance>.

To meet overall New Zealand final product compliance, the developer must construct a compliance folder containing all relevant compliance test reports e.g. RF, EMC, electrical safety and DoC (Declaration of Conformity) etc. It is the responsibility of the developer to know what is required in the compliance folder for New Zealand Radio communications. For more information on New Zealand compliance, refer to the web site <http://www.rsm.govt.nz/>.

4.5.1 EXTERNAL ANTENNA REQUIREMENTS

The compliance testing listed in [Table 4-1](#) was performed using the antenna types listed in [Table 3-1](#).

4.5.2 HELPFUL WEB SITES

Radio Spectrum Ministry of Economic Development: <http://www.rsm.govt.nz/>.

4.6 Japan

The RN1810/RN1810E module has received type certification and is labeled with its own technical conformity mark and certification number as required to conform to the technical standards regulated by the Ministry of Internal Affairs and Communications (MIC) of Japan pursuant to the Radio Act of Japan.

Integration of this module into a final product does not require additional radio certification provided installation instructions are followed and no modifications of the module are allowed. Additional testing may be required:

- If the host product is subject to electrical appliance safety (for example, powered from an AC mains), the host product may require Product Safety Electrical Appliance and Material (PSE) testing. The integrator should contact their conformance laboratory to determine if this testing is required.
- There is a voluntary Electromagnetic Compatibility (EMC) test for the host product administered by VCCI: http://www.vcci.jp/vcci_e/index.html

4.6.1 LABELING AND USER INFORMATION REQUIREMENTS

The label on the final product which contains the RN1810/RN1810E module must follow Japan marking requirements. The integrator of the module should refer to the labeling requirements for Japan available at the Ministry of Internal Affairs and Communications (MIC) website.

The RN1810/RN1810E module is labeled with its own technical conformity mark and certification number. The final product in which this module is being used must have a label referring to the type certified module inside:

Contains transmitter module with certificate number:



4.6.2 HELPFUL WEB SITES

Ministry of Internal Affairs and Communications (MIC): <http://www.tele.soumu.go.jp/e/index.htm>

Association of Radio Industries and Businesses (ARIB): <http://www.arib.or.jp/english/>

4.7 Korea

The RN1810/RN1810E module has received certification of conformity in accordance with the Radio Waves Act. Integration of this module into a final product does not require additional radio certification provided installation instructions are followed and no modifications of the module are allowed.

4.7.1 LABELING AND USER INFORMATION REQUIREMENTS

The label on the final product which contains the RN1810/RN1810E module must follow KC marking requirements. The integrator of the module should refer to the labeling requirements for Korea available on the Korea Communications Commission (KCC) website.

The RN1810/RN1810E module is labeled with its own KC mark. The final product requires the KC mark and certificate number of the module:

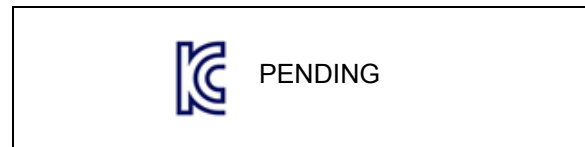

4.7.2 EXTERNAL ANTENNA REQUIREMENTS

The Korea compliance testing was performed using the antenna types listed in [Table 3-1](#).

4.7.3 HELPFUL WEB SITES

Korea Communications Commission (KCC): <http://www.kcc.go.kr>.

National Radio Research Agency (RRA): <http://rra.go.kr>.

RN1810/RN1810E

4.8 Taiwan

The RN1810/RN1810E module has received compliance approval in accordance with the Telecommunications Act. Customers seeking to use the compliance approval in their product should contact Microchip Technology sales or distribution partners to obtain a Letter of Authority.

Integration of this module into a final product does not require additional radio certification provided installation instructions are followed and no modifications of the module are allowed.

4.8.1 LABELING AND USER INFORMATION REQUIREMENTS

The RN1810/RN1810E module is labeled with its own NCC ID number, and if the NCC ID is not visible when the module is installed inside another device, then the outside of the device must also display a label referring to the enclosed module. This exterior label can use wording such as the following:

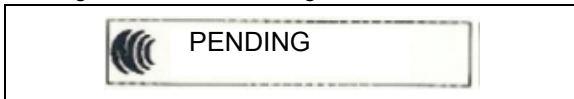

The user's manual should contain below warning (for RF device) in traditional Chinese:

注意！

依據 低功率電波輻射性電機管理辦法

第十二條 經型式認證合格之低功率射頻電機，非經許可，

公司、商號或使用者均不得擅自變更頻率、加大功率或變更原設計之特性及功能。

第十四條 低功率射頻電機之使用不得影響飛航安全及干擾合法通信；

經發現有干擾現象時，應立即停用，並改善至無干擾時方得繼續使用。

前項合法通信，指依電信規定作業之無線電信。

低功率射頻電機須忍受合法通信或工業、科學及醫療用電波輻射性電機設備之干擾。

4.8.2 EXTERNAL ANTENNA REQUIREMENTS

The Taiwan compliance testing was performed using the antenna types listed in [Table 3-1](#).

4.8.3 HELPFUL WEB SITES

National Communications Commission (NCC):
<http://www.ncc.gov.tw>.

4.9 Other Regulatory Jurisdictions

Should other regulatory jurisdiction certification be required by the customer, or the customer need to recertify the module for other reasons, a certification utility is available. For further regulatory Certification Utility and documentation, contact your local Microchip Technology sales office.

5.0 ELECTRICAL CHARACTERISTICS

Table 5-1, Table 5-2, Table 5-3 and Table 5-4 provide the absolute maximum ratings, recommended operating conditions, current consumption and the DC characteristics for digital IO pins of the module.

TABLE 5-1: ABSOLUTE MAXIMUM RATINGS⁽¹⁾

Symbol	Description	Max Rating	Units
V _{DD}	Voltage on V _{DD} with respect to GND	-0.3 to 4.0	V
V _{DI} Min.	Minimum digital input voltage	-0.3	V
V _{DO} Max.	Maximum digital input voltage	V _{DD} +0.3	V
RF _{IN}	Maximum RF input (referenced to 50 ohms)	+10	dBm

Note 1: Stresses above those listed under “Absolute Maximum Ratings” may cause permanent damage to the device. This is a stress rating only and functional operation of the device at those or any other conditions above those indicated in the operation listings of this specification is not implied. Exposure above maximum rating conditions for extended periods may affect device reliability.

TABLE 5-2: RECOMMENDED OPERATING CONDITIONS

Symbol		Min.	Typ.	Max.	Units
V _{DD}	Supply voltage	3.15	3.3	3.45	V
T _{AMB}	Ambient temperature under bias	-40	—	85	°C

TABLE 5-3: CURRENT CONSUMPTION⁽¹⁾ (NOMINAL CONDITIONS: 25°C, V_{DD} = 3.3V)

Parameters	Min	Typ.	Max	Units	Conditions ⁽²⁾
IDD, Sleep	—	12	—	µA	—
IDD, Receive	—	61	—	mA	11 Mbps
	—	64	—		54 Mbps
	—	62	—		HT20 MCS0
	—	64	—		HT20 MCS7
	—	72	—		HT40 MCS0
	—	73	—		HT40 MCS7
IDD, Transmit	—	248	—	mA	1 Mbps
	—	246	—		6 Mbps
	—	242	—		11 Mbps
	—	211	—		54 Mbps
	—	263	—		HT20 MCS0
	—	217	—		HT20 MCS7
	—	222	—		HT40 MCS0
	—	196	—		HT40 MCS7

Note 1: Current Consumption values represent Typical Peak currents. Wi-Fi applications typically operate at less than 85% TX duty cycle. TX current is dependent on such criteria as transmit power setting, transmit data rate, and bandwidth used. RX current is affected by connection distance.

2: Transmit current consumption at power output levels is listed in Table 5-6.

TABLE 5-4: DC CHARACTERISTICS FOR DIGITAL IO PINS

DC CHARACTERISTICS		Operating Conditions ⁽¹⁾			
Symbol	Parameter	Min.	Typ.	Max.	Units
V _{IH}	High-Level Input Voltage	1.8	—	3.6	V
V _{IL}	Low-Level Input Voltage	-0.3	—	0.3	V

RN1810/RN1810E

TABLE 5-4: DC CHARACTERISTICS FOR DIGITAL IO PINS (CONTINUED)

DC CHARACTERISTICS		Operating Conditions ⁽¹⁾			
Symbol	Parameter	Min.	Typ.	Max.	Units
V _{OH}	High-Level Output Voltage	2.2	—	3.3	V
V _{OL}	Low-Level Output Voltage	0	—	0.4	V
I _{IH}	High-Level Input Current	—	—	0.1	μA
I _{IL}	Low-Level Input Current	—	—	0.1	μA
I _{OH}	High-Level Output Current	—	—	20	mA
I _{OL}	Low-Level Output Current	—	—	20	mA
C _{IN}	Input Capacitance	—	3	—	pF

Note: Operating temperature: 25°C; Operating voltage: V_{DD} = 3.3V

Table 5-5, Table 5-6 and Table 5-7 show the frequency characteristics of the module.

TABLE 5-5: RADIO RECEIVE CHARACTERISTICS

Symbol	Parameter	Conditions	Min	Typ ⁽¹⁾	Max	Unit
frx	RX input frequency range	—	2.412	—	2.472	GHz
SRF	Sensitivity					
	CCK	1 Mbps	—	-95.7	—	dBm
		11 Mbps	—	-87.7	—	
	OFDM	6 Mbps	—	-92.7	—	
		54 Mbps	—	-75.7	—	
	HT20	MCS0	—	-92.7	—	
		MCS7	—	-72.7	—	
	HT40	MCS0	—	-90.7	—	
MCS7		—	-69.7	—		

Note 1: Performance measured at J1.

TABLE 5-6: RADIO TRANSMIT CHARACTERISTICS

Symbol	Parameter	Conditions	Min	Typ	Max	Unit
frx	TX output frequency range	—	2.412	—	2.472	GHz
p _{OUT}	Output power ⁽¹⁾					
	802.11b mask compliant	1 Mbps	—	20.7	—	dBm
	802.11g mask compliant	6 Mbps	—	20.7	—	
	802.11g EVM compliant	54 Mbps	—	18.8	—	
	802.11n HT20 mask compliant	MCS0	—	20.7	—	
	802.11n HT40 mask compliant	MCS0	—	18.5	—	
	802.11n HT20 EVM compliant	MCS7	—	18.0	—	
802.11n HT40 EVM compliant	MCS7	—	18.4	—		
a _{PC}	Accuracy of power control	—	—	+/-1.5	—	dB

Note 1: Performance measured at J1.

TABLE 5-7: SYNTHESIZER CHARACTERISTICS

Symbol	Parameter	Conditions	Min	Typ	Max	Unit
f _c	Center channel frequency	Center frequency at 5 MHz spacing	2.412	—	2.472	GHz
f _{REF}	Reference oscillator frequency	+/-20 ppm	—	40	—	MHz
f _{STEP}	Frequency step size (at RF)	—	—	5	—	MHz

APPENDIX A: REVISION HISTORY

Revision A (January 2016)

This is the initial released version of the document.

RN1810/RN1810E

NOTES:

THE MICROCHIP WEB SITE

Microchip provides online support via our WWW site at www.microchip.com. This web site is used as a means to make files and information easily available to customers. Accessible by using your favorite Internet browser, the web site contains the following information:

- **Product Support** – Data sheets and errata, application notes and sample programs, design resources, user's guides and hardware support documents, latest software releases and archived software
- **General Technical Support** – Frequently Asked Questions (FAQ), technical support requests, online discussion groups, Microchip consultant program member listing
- **Business of Microchip** – Product selector and ordering guides, latest Microchip press releases, listing of seminars and events, listings of Microchip sales offices, distributors and factory representatives

CUSTOMER CHANGE NOTIFICATION SERVICE

Microchip's customer notification service helps keep customers current on Microchip products. Subscribers will receive e-mail notification whenever there are changes, updates, revisions or errata related to a specified product family or development tool of interest.

To register, access the Microchip web site at www.microchip.com. Under "Support", click on "Customer Change Notification" and follow the registration instructions.

CUSTOMER SUPPORT

Users of Microchip products can receive assistance through several channels:

- Distributor or Representative
- Local Sales Office
- Field Application Engineer (FAE)
- Technical Support

Customers should contact their distributor, representative or Field Application Engineer (FAE) for support. Local sales offices are also available to help customers. A listing of sales offices and locations is included in the back of this document.

Technical support is available through the web site at: <http://microchip.com/support>.

RN1810/RN1810E

NOTES:

PRODUCT IDENTIFICATION SYSTEM

To order or obtain information, e.g., on pricing or delivery, refer to the factory or the listed sales office.

<u>PART NO.</u>				
Device	Temperature Range	Package	Firmware Revision Number	Examples:
Device:	RN1810:	Integral Antenna		RN1810-I/RM100
	RN1810E:	External Antenna Connection		
Temperature Range:	I	=	-40°C to +85°C (Industrial)	
Package:	RM	=	Radio Module	

RN1810/RN1810E

NOTES:

Note the following details of the code protection feature on Microchip devices:

- Microchip products meet the specification contained in their particular Microchip Data Sheet.
- Microchip believes that its family of products is one of the most secure families of its kind on the market today, when used in the intended manner and under normal conditions.
- There are dishonest and possibly illegal methods used to breach the code protection feature. All of these methods, to our knowledge, require using the Microchip products in a manner outside the operating specifications contained in Microchip's Data Sheets. Most likely, the person doing so is engaged in theft of intellectual property.
- Microchip is willing to work with the customer who is concerned about the integrity of their code.
- Neither Microchip nor any other semiconductor manufacturer can guarantee the security of their code. Code protection does not mean that we are guaranteeing the product as “unbreakable.”

Code protection is constantly evolving. We at Microchip are committed to continuously improving the code protection features of our products. Attempts to break Microchip's code protection feature may be a violation of the Digital Millennium Copyright Act. If such acts allow unauthorized access to your software or other copyrighted work, you may have a right to sue for relief under that Act.

Information contained in this publication regarding device applications and the like is provided only for your convenience and may be superseded by updates. It is your responsibility to ensure that your application meets with your specifications. MICROCHIP MAKES NO REPRESENTATIONS OR WARRANTIES OF ANY KIND WHETHER EXPRESS OR IMPLIED, WRITTEN OR ORAL, STATUTORY OR OTHERWISE, RELATED TO THE INFORMATION, INCLUDING BUT NOT LIMITED TO ITS CONDITION, QUALITY, PERFORMANCE, MERCHANTABILITY OR FITNESS FOR PURPOSE. Microchip disclaims all liability arising from this information and its use. Use of Microchip devices in life support and/or safety applications is entirely at the buyer's risk, and the buyer agrees to defend, indemnify and hold harmless Microchip from any and all damages, claims, suits, or expenses resulting from such use. No licenses are conveyed, implicitly or otherwise, under any Microchip intellectual property rights unless otherwise stated.

Microchip received ISO/TS-16949:2009 certification for its worldwide headquarters, design and wafer fabrication facilities in Chandler and Tempe, Arizona; Gresham, Oregon and design centers in California and India. The Company's quality system processes and procedures are for its PIC® MCUs and dsPIC® DSCs, KEELOQ® code hopping devices, Serial EEPROMs, microperipherals, nonvolatile memory and analog products. In addition, Microchip's quality system for the design and manufacture of development systems is ISO 9001:2000 certified.

**QUALITY MANAGEMENT SYSTEM
CERTIFIED BY DNV
= ISO/TS 16949 =**

Trademarks

The Microchip name and logo, the Microchip logo, AnyRate, dsPIC, FlashFlex, flexPWR, Heldo, JukeBlox, KeeLoq, KeeLoq logo, Klear, LANCheck, LINK MD, MediaLB, MOST, MOST logo, MPLAB, OptoLyzer, PIC, PICSTART, PIC32 logo, RightTouch, SpyNIC, SST, SST Logo, SuperFlash and UNI/O are registered trademarks of Microchip Technology Incorporated in the U.S.A. and other countries.

ClockWorks, The Embedded Control Solutions Company, ETHERSYNCH, Hyper Speed Control, HyperLight Load, IntelliMOS, mTouch, Precision Edge, and QUIET-WIRE are registered trademarks of Microchip Technology Incorporated in the U.S.A.

Analog-for-the-Digital Age, Any Capacitor, AnyIn, AnyOut, BodyCom, chipKIT, chipKIT logo, CodeGuard, dsPICDEM, dsPICDEM.net, Dynamic Average Matching, DAM, ECAN, EtherGREEN, In-Circuit Serial Programming, ICSP, Inter-Chip Connectivity, JitterBlocker, KlearNet, KlearNet logo, MiWi, motorBench, MPASM, MPF, MPLAB Certified logo, MPLIB, MPLINK, MultiTRAK, NetDetach, Omniscient Code Generation, PICDEM, PICDEM.net, PICkit, PICtail, PureSilicon, RightTouch logo, REAL ICE, Ripple Blocker, Serial Quad I/O, SQL, SuperSwitcher, SuperSwitcher II, Total Endurance, TSHARC, USBCheck, VariSense, ViewSpan, WiperLock, Wireless DNA, and ZENA are trademarks of Microchip Technology Incorporated in the U.S.A. and other countries.

SQTP is a service mark of Microchip Technology Incorporated in the U.S.A.

Silicon Storage Technology is a registered trademark of Microchip Technology Inc. in other countries.

GestIC is a registered trademarks of Microchip Technology Germany II GmbH & Co. KG, a subsidiary of Microchip Technology Inc., in other countries.

All other trademarks mentioned herein are property of their respective companies.

© 2016, Microchip Technology Incorporated, Printed in the U.S.A., All Rights Reserved.

ISBN: 978-1-5224-0249-7



MICROCHIP

Worldwide Sales and Service

AMERICAS

Corporate Office

2355 West Chandler Blvd.
Chandler, AZ 85224-6199

Tel: 480-792-7200

Fax: 480-792-7277

Technical Support:

[http://www.microchip.com/
support](http://www.microchip.com/support)

Web Address:

www.microchip.com

Atlanta

Duluth, GA

Tel: 678-957-9614

Fax: 678-957-1455

Austin, TX

Tel: 512-257-3370

Boston

Westborough, MA

Tel: 774-760-0087

Fax: 774-760-0088

Chicago

Itasca, IL

Tel: 630-285-0071

Fax: 630-285-0075

Cleveland

Independence, OH

Tel: 216-447-0464

Fax: 216-447-0643

Dallas

Addison, TX

Tel: 972-818-7423

Fax: 972-818-2924

Detroit

Novi, MI

Tel: 248-848-4000

Houston, TX

Tel: 281-894-5983

Indianapolis

Noblesville, IN

Tel: 317-773-8323

Fax: 317-773-5453

Los Angeles

Mission Viejo, CA

Tel: 949-462-9523

Fax: 949-462-9608

New York, NY

Tel: 631-435-6000

San Jose, CA

Tel: 408-735-9110

Canada - Toronto

Tel: 905-673-0699

Fax: 905-673-6509

ASIA/PACIFIC

Asia Pacific Office

Suites 3707-14, 37th Floor
Tower 6, The Gateway
Harbour City, Kowloon

Hong Kong

Tel: 852-2943-5100

Fax: 852-2401-3431

Australia - Sydney

Tel: 61-2-9868-6733

Fax: 61-2-9868-6755

China - Beijing

Tel: 86-10-8569-7000

Fax: 86-10-8528-2104

China - Chengdu

Tel: 86-28-8665-5511

Fax: 86-28-8665-7889

China - Chongqing

Tel: 86-23-8980-9588

Fax: 86-23-8980-9500

China - Dongguan

Tel: 86-769-8702-9880

China - Hangzhou

Tel: 86-571-8792-8115

Fax: 86-571-8792-8116

China - Hong Kong SAR

Tel: 852-2943-5100

Fax: 852-2401-3431

China - Nanjing

Tel: 86-25-8473-2460

Fax: 86-25-8473-2470

China - Qingdao

Tel: 86-532-8502-7355

Fax: 86-532-8502-7205

China - Shanghai

Tel: 86-21-5407-5533

Fax: 86-21-5407-5066

China - Shenyang

Tel: 86-24-2334-2829

Fax: 86-24-2334-2393

China - Shenzhen

Tel: 86-755-8864-2200

Fax: 86-755-8203-1760

China - Wuhan

Tel: 86-27-5980-5300

Fax: 86-27-5980-5118

China - Xian

Tel: 86-29-8833-7252

Fax: 86-29-8833-7256

ASIA/PACIFIC

China - Xiamen

Tel: 86-592-2388138

Fax: 86-592-2388130

China - Zhuhai

Tel: 86-756-3210040

Fax: 86-756-3210049

India - Bangalore

Tel: 91-80-3090-4444

Fax: 91-80-3090-4123

India - New Delhi

Tel: 91-11-4160-8631

Fax: 91-11-4160-8632

India - Pune

Tel: 91-20-3019-1500

Japan - Osaka

Tel: 81-6-6152-7160

Fax: 81-6-6152-9310

Japan - Tokyo

Tel: 81-3-6880-3770

Fax: 81-3-6880-3771

Korea - Daegu

Tel: 82-53-744-4301

Fax: 82-53-744-4302

Korea - Seoul

Tel: 82-2-554-7200

Fax: 82-2-558-5932 or

82-2-558-5934

Malaysia - Kuala Lumpur

Tel: 60-3-6201-9857

Fax: 60-3-6201-9859

Malaysia - Penang

Tel: 60-4-227-8870

Fax: 60-4-227-4068

Philippines - Manila

Tel: 63-2-634-9065

Fax: 63-2-634-9069

Singapore

Tel: 65-6334-8870

Fax: 65-6334-8850

Taiwan - Hsin Chu

Tel: 886-3-5778-366

Fax: 886-3-5770-955

Taiwan - Kaohsiung

Tel: 886-7-213-7828

Taiwan - Taipei

Tel: 886-2-2508-8600

Fax: 886-2-2508-0102

Thailand - Bangkok

Tel: 66-2-694-1351

Fax: 66-2-694-1350

EUROPE

Austria - Wels

Tel: 43-7242-2244-39

Fax: 43-7242-2244-393

Denmark - Copenhagen

Tel: 45-4450-2828

Fax: 45-4485-2829

France - Paris

Tel: 33-1-69-53-63-20

Fax: 33-1-69-30-90-79

Germany - Dusseldorf

Tel: 49-2129-3766400

Germany - Karlsruhe

Tel: 49-721-625370

Germany - Munich

Tel: 49-89-627-144-0

Fax: 49-89-627-144-44

Italy - Milan

Tel: 39-0331-742611

Fax: 39-0331-466781

Italy - Venice

Tel: 39-049-7625286

Netherlands - Drunen

Tel: 31-416-690399

Fax: 31-416-690340

Poland - Warsaw

Tel: 48-22-3325737

Spain - Madrid

Tel: 34-91-708-08-90

Fax: 34-91-708-08-91

Sweden - Stockholm

Tel: 46-8-5090-4654

UK - Wokingham

Tel: 44-118-921-5800

Fax: 44-118-921-5820

07/14/15

Компания «Океан Электроники» предлагает заключение долгосрочных отношений при поставках импортных электронных компонентов на взаимовыгодных условиях!

Наши преимущества:

- Поставка оригинальных импортных электронных компонентов напрямую с производств Америки, Европы и Азии, а так же с крупнейших складов мира;
- Широкая линейка поставок активных и пассивных импортных электронных компонентов (более 30 млн. наименований);
- Поставка сложных, дефицитных, либо снятых с производства позиций;
- Оперативные сроки поставки под заказ (от 5 рабочих дней);
- Экспресс доставка в любую точку России;
- Помощь Конструкторского Отдела и консультации квалифицированных инженеров;
- Техническая поддержка проекта, помощь в подборе аналогов, поставка прототипов;
- Поставка электронных компонентов под контролем ВП;
- Система менеджмента качества сертифицирована по Международному стандарту ISO 9001;
- При необходимости вся продукция военного и аэрокосмического назначения проходит испытания и сертификацию в лаборатории (по согласованию с заказчиком);
- Поставка специализированных компонентов военного и аэрокосмического уровня качества (Xilinx, Altera, Analog Devices, Intersil, Interpoint, Microsemi, Actel, Aeroflex, Peregrine, VPT, Syfer, Eurofarad, Texas Instruments, MS Kennedy, Miteq, Cobham, E2V, MA-COM, Hittite, Mini-Circuits, General Dynamics и др.);

Компания «Океан Электроники» является официальным дистрибьютором и эксклюзивным представителем в России одного из крупнейших производителей разъемов военного и аэрокосмического назначения «JONHON», а так же официальным дистрибьютором и эксклюзивным представителем в России производителя высокотехнологичных и надежных решений для передачи СВЧ сигналов «FORSTAR».



JONHON

«JONHON» (основан в 1970 г.)

Разъемы специального, военного и аэрокосмического назначения:

(Применяются в военной, авиационной, аэрокосмической, морской, железнодорожной, горно- и нефтедобывающей отраслях промышленности)

«FORSTAR» (основан в 1998 г.)

ВЧ соединители, коаксиальные кабели, кабельные сборки и микроволновые компоненты:

(Применяются в телекоммуникациях гражданского и специального назначения, в средствах связи, РЛС, а так же военной, авиационной и аэрокосмической отраслях промышленности).



Телефон: 8 (812) 309-75-97 (многоканальный)

Факс: 8 (812) 320-03-32

Электронная почта: ocean@oceanchips.ru

Web: <http://oceanchips.ru/>

Адрес: 198099, г. Санкт-Петербург, ул. Калинина, д. 2, корп. 4, лит. А