



**austriamicrosystems AG**

**is now**

**ams AG**

The technical content of this austriamicrosystems datasheet is still valid.

**Contact information:**

**Headquarters:**

ams AG

Tobelbaderstrasse 30

8141 Unterpremstaetten, Austria

Tel: +43 (0) 3136 500 0

e-Mail: [ams\\_sales@ams.com](mailto:ams_sales@ams.com)

Please visit our website at [www.ams.com](http://www.ams.com)

Multi-Standard CMOS Telephone IC  
for Basic Telephones  
**AS2533-36**

**General Description**

The AS253x is a CMOS integrated circuit that contains all the functions needed to build a high performance electronic telephone set with basic features.

The AS253x incorporates a line interface, a speech circuit, a dialler and ringer. It is a real single-chip / single-die IC with 28 pins. It allows either package mounting or chip-on-board mounting.

The device is available in 4 versions (pin-compatible) with different features ranging from LNR only (last number redial) to 4 direct (one-touch) memories and 10 indirect (two-touch) memories. The sliding cursor procedure makes the LNR function easy to use under various PABX systems.

The versatility of the circuit is provided by pin options and a few external components. This allows fast time-to-market and easy adaptation to different PTT requirements. A unique EMI performance has been achieved due to the consequent use of CMOS amplifiers.

**Key Features**

**Line Interface and Speech Circuit**

- Electronic Rx volume control
- Electronic microphone mute
- Microphone amplifier with symmetrical input

- Rx and Tx soft clipping to avoid harsh distortion
- Real or complex impedance (EU compliant)
- Stabilized supply for dialler and peripherals
- Automatic line loss compensation
- Operating range from 13 to 100 mA (down to 5 mA with reduced performance)
- Unique EMI performance (EU compliant)

**Dialler**

- LD/MF dialing and mixed-mode dialing
- 31 digit last number redial (LNR)
- 4 direct/10 indirect (AS2533/36), 12 direct (AS2535)
- Repeat dialing by busy or engaged (not AS2535)
- Confidence tone during memory programming and mute
- Notepad memory function
- Pause key for access pause or wait function
- 3 flash timings, 100 ms, 280 ms and 375/600 ms
- Sliding cursor protocol with comparison

**Ringer**

- Ring frequency discrimination
- 3-tone melody generator
- Ring melody selection via keyboard
- Ring volume selection via keyboard
- Version available with fixed ring melody and ring volume

**Package**

- SOIC 28 or DIE

**Block Diagram**



Figure 1 Block Diagram

## Pin Description

Pin #	Symbol	Function																		
4	V <sub>DD</sub>	Positive Voltage Supply This is the supply pin for the circuit.																		
5	A <sub>GND</sub>	Analog Ground This is the analogue ground for the amplifiers.																		
6	STB	Side Tone Balance Input This is the input for side tone cancellation.																		
7	CI	Complex Impedance Pin For complex impedance a capacitor should be connected to																		
8	MO	Melody Output PDM output of the melody generator for tone ringing with internal open-drain transistor. Hi-Z when not active.																		
9	LLC	Line Loss Compensation Select pin for line loss compensation (see also Figure 6 and Figure 7). LLC = A <sub>GND</sub> : 20 - 50 mA LLC = V <sub>DD</sub> : 45 - 75 mA LLC = V <sub>SS</sub> : none.																		
10	HS/DP	Hook Switch Input and Dial Pulse Output This is an I/O that is pulled high by the hook switch when off-hook and an open drain pulls it low during break periods of pulse dialing and flash.																		
11	OSC	OSCillator Input Pin for ceramic resonator (3.58 MHz). Reference: Murata CSTCC3M58GD3346-R0 SMD Murata CSTLS3M58GD3458-B0 Lead																		
12	MODE	Signaling MODE Select Input <table border="1" data-bbox="508 1209 1412 1633"> <thead> <tr> <th>Mode pin</th> <th>Function</th> </tr> </thead> <tbody> <tr> <td>Open</td> <td>Dialing inhibited</td> </tr> <tr> <td>Row 1</td> <td>LD mode, 10 pps, 33/66 ms</td> </tr> <tr> <td>Row 2</td> <td>LD mode, 10 pps, 40/60 ms</td> </tr> <tr> <td>Row 3</td> <td>LD mode, 20 pps, 33/66 ms</td> </tr> <tr> <td>Row 4</td> <td>LD mode, 20 pps, 40/60 ms</td> </tr> <tr> <td>Row 5</td> <td>LD mode, 10 pps, 33/66 ms, Temp. MF with tone on first * key entry</td> </tr> <tr> <td>Row 61</td> <td>MF only, 82/82 ms</td> </tr> <tr> <td>Row 7</td> <td>MF only, 82/160 ms</td> </tr> </tbody> </table> <p>During temporary MF: 82/160 ms</p>	Mode pin	Function	Open	Dialing inhibited	Row 1	LD mode, 10 pps, 33/66 ms	Row 2	LD mode, 10 pps, 40/60 ms	Row 3	LD mode, 20 pps, 33/66 ms	Row 4	LD mode, 20 pps, 40/60 ms	Row 5	LD mode, 10 pps, 33/66 ms, Temp. MF with tone on first * key entry	Row 61	MF only, 82/82 ms	Row 7	MF only, 82/160 ms
Mode pin	Function																			
Open	Dialing inhibited																			
Row 1	LD mode, 10 pps, 33/66 ms																			
Row 2	LD mode, 10 pps, 40/60 ms																			
Row 3	LD mode, 20 pps, 33/66 ms																			
Row 4	LD mode, 20 pps, 40/60 ms																			
Row 5	LD mode, 10 pps, 33/66 ms, Temp. MF with tone on first * key entry																			
Row 61	MF only, 82/82 ms																			
Row 7	MF only, 82/160 ms																			
13	C4	Keyboard Columns (see key arrangements in Figure 2, Figure 3 and Figure 4)																		
14	C3																			
15	C2																			
16	C1																			

Pin #	Symbol	Function
17	R4	Keyboard Rows (see key arrangements in Figure 2, Figure 3 and Figure 4)
18	R3	
19	R2	
20	R1	
21	FCI	Frequency Comparator Input This is a Schmitt trigger input for ring frequency discrimination. Disabled during off-hook.
22	LED	LED Output Driver Output for driving an LED that will be flashing when in Program/Mute state.
23	M1	Microphone Inputs Differential inputs for the microphone (electret).
24	M2	
25	CS	Current Shunt Control Output This N-channel open drain output controls the external high power shunt transistor for the modulation of the line voltage and for shorting the line during make period of pulse dialing.
26	V <sub>SS</sub>	Negative Power Supply
27	LI	Line Input This input is used for power extraction and line current sensing.
28	RI	Receive Input This is the input for the receive signal.
1	LS	Line Current Sense Input This is the input for sensing the line current.
2	MFL	MF Level Setting A voltage divider connected from this pin to A <sub>GN</sub> D and V <sub>SS</sub> can be used to set the DTMF level.
3	RO	Receive Output This is the output for driving a dynamic earpiece with an impedance of 150 to 300 Ω.

## Selection Overview

Function	AS2533	AS2534/34R	AS2535	AS2536
Direct memories (one-key)	4	0	12	4
Indirect memories (two-key)	10	0	0	10
Repeat dialing	yes	yes	no	yes
LNR key	yes	yes	yes	yes
Pause insertion by LNR key	yes	yes	yes	yes
Pause (PS) key	yes	yes	no	yes
P/M or MT key	P/M	P/M	P/M	P/M
Tone/Pulse (T/P) key	yes	yes	no	yes
Temporary MF by * key	yes	yes	yes	yes
Centrex (A - D) keys	yes	yes	no	yes
Volume (VOL, -/+ ) keys	yes	yes	yes	yes
Volume reset by off-hook	yes	no	yes	no
Programming of tone ringer	yes	AS2534:yes AS2534R: no	yes	yes
R3 Flash duration	600 ms	600 ms	600 ms	600 ms

The corresponding product (AS2533-36) can be selected via bond-options (see chapter "Bond options" for details).

## Functional Description

### Keyboard Connections

(Either VOL or +/- keys)

Key closure,  $R_{ON\ max.} = 1\ k\Omega$

Key open,  $R_{OFF\ min.} = 1\ M\Omega$



Figure 2 Keyboard Connection AS2533/36



Figure 3 Keyboard Connection AS2534

**Keyboard Connections continued**

(either VOL or +/- keys)

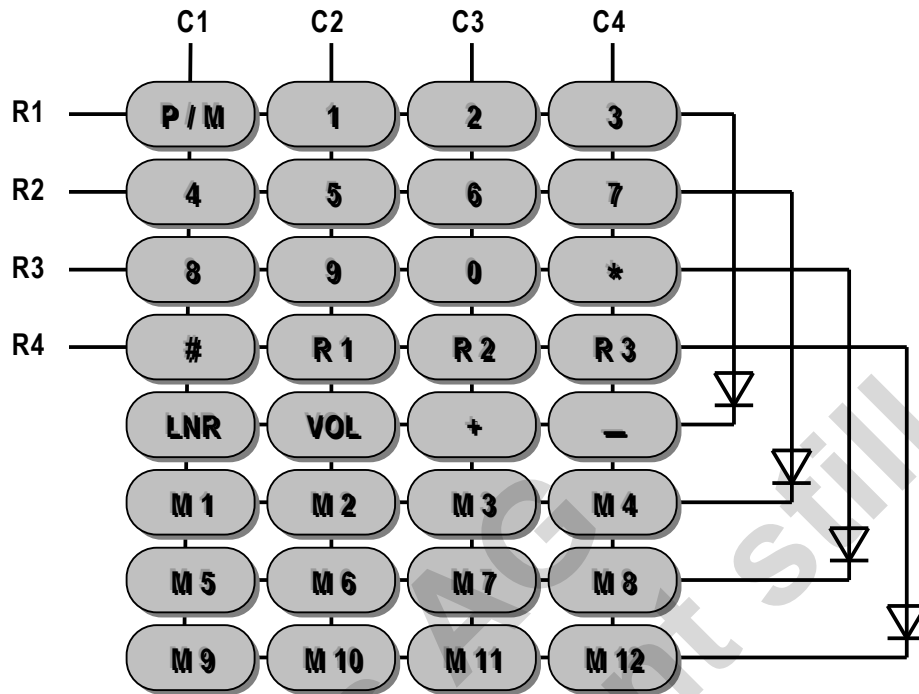

Figure 4 Keyboard Connection AS2535

**Power On Reset**

The on chip power on reset circuit monitors the supply voltage ( $V_{DD}$ ) during off-hook. When  $V_{DD}$  rises above approx. 1.2V, a power on reset occurs which clears the RAM.

**DC Conditions**

The normal operating range is from 13 mA to 100 mA. Operating range with reduced performance is from 5 mA to 13 mA (parallel operation). In the operating range all functions are operational.

At line currents below 13 mA the AS253x provides an additional slope below 4.5V in order to allow parallel operation (see Figure 12).

The dc characteristic (excluding diode bridge) is determined by the voltage at LI and the resistor R1 at line currents above 13 mA as follows:

$$VLS = VLI + ILINE \times R1$$

The voltage at LI is 4.5V in the normal operating range.

During pulse dialing the speech circuit and other part of the device not operating is in a power down mode to save current. The CS pin is pulled to  $V_{SS}$  in order to turn the external shunt transistor on to keep a low voltage drop at the LS pin during make periods.

**AC Impedance**

The ac impedance of the circuit is set by external components. The impedance can be real or complex. The ac impedance is determined as follows:

$$ZAC = 33 \cdot Z1$$

The dc value of Z1 should be 30  $\Omega$  to maintain correct dc performance.

Return loss and side tone cancellation can be determined independent of each other.

**Speech Circuit**

The speech circuit consists of a transmit and a receive path with dual soft clipping, mute, line loss compensation and sidetone cancellation.

### Transmit

The gain of the transmit path is 37 dB for 600 Ω line termination from M1/M2 to LS (see test circuit Figure 9).

The microphone input is differential with an input impedance of 20 kΩ.

The soft clip circuit limits the output voltage at LI to 2V<sub>PEAK</sub> (see Figure 11). The attack time is 30 μs/6 dB and the decay time is 20 ms/6 dB. When mute is active, during dialing or after pressing the **P/M** key, the gain reduced by > 60 dB.

### Receive

The gain of the receive path is 3 dB for 600 Ω line termination (test circuit Figure 9). The receive input the differential signal of RI and STB. When mute is active during dialing the gain is reduced by > 60 dB. During DTMF dialing a MF comfort tone is applied to the receiver. The comfort tone is the DTMF signal with level that is -30 dB relative to the line signal.

The receive gain can be changed by pressing the volume keys. The **VOL** key gives a +5.4 dB boost and has a toggle function, i.e. repressing the key resets the gain to default. As an alternative the +/- keys can be used. The + key increases the gain by 8.1 dB in 3 steps and the - key decreases the gain by 5.4 dB in 2 steps (total range 13.5 dB). On AS2533/35 the volume is reset to default by next off-hook and on AS2534/36 the volume setting will remain at last setting. A POR will always reset the volume to default.

The soft clip circuit limits the voltage at the receive output (RO) to 1V<sub>PEAK</sub> (see Figure 10). It prevents harsh distortion and acoustic shock.

### Sidetone

A good sidetone cancellation is achieved by using the following equation:

$$\frac{Z_{Line}}{Z_{BAL}} = \frac{Z_2}{Z_1}$$

The sidetone cancellation signal is applied to the STB input.

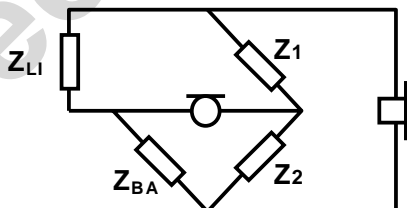

Figure 5 Side Tone Balance

### Line Loss Compensation

The line loss compensation is a pin option. When it is activated, the transmit and receive gains are decreased by 6 dB at line currents from 20 to 50 mA when LLC = A<sub>GND</sub> and 45 to 75 mA when LLC = high (@ R1 = 30 Ω). The line loss compensation is disabled when LLC = low (see Figure 6 and Figure 7).

### Dialing Functions

#### Valid Keys

The key scanning is enabled when HS/DPN is pulled high and V<sub>DD</sub> is above V<sub>REF</sub>. A valid key is detected from the keyboard by connecting the appropriate row to the column (R<sub>ON</sub> < 1 kΩ). This can be done using an n x m keyboard matrix with single contacts. Four diodes are used to extend the number of rows (see keyboard arrangement fig. 2). It is also possible to connect a microcontroller to the rows and columns (see application note AN3010).

#### P/M and MT Key

The **P/M** key is used to enter the Program/Mute state. Depressing the **P/M** key mutes the speech circuit and the device is in program state. Repressing the **P/M** key deactivates the mute and program state (toggle function). The **MT** key works in similar way, but has no program function.

When program/mute is activated, the LED indication is turned on (flashing: 80 ms 'on' and 1 sec 'off').

#### Dial Mode Selection

The default mode (LD or MF) can be selected by the mode pin. When default LD mode is selected, a temporary change to MF can be invoked by pressing **T/P** key (not AS2535) or the \* key (when mode pin = row 5, the MF tone is generated with the first \* key entry). The circuit will revert to LD by repressing the **T/P** key (not AS2535) or by pressing the **R** (**R1**, **R2** or **R3**) key or by next on-hook.

When MF mode is selected by the mode pin, the circuit can not be changed temporary to LD but will remain in MF mode.

#### Centrex Keys (not AS2535)

The alphanumeric keys accommodate easy use of centrex services. The A, B, C and D keys are only valid in MF mode (including temporary MF) and are not storable. Pressing one of these keys will invoke the appropriate MF tones to be transmitted.

The centrex keys are not stored in the RAM, and subsequently entered digits are buffered in FIFO.

**Last Number Redial**

LNR is a facility that allows resigalling of the last manually dialed number without keying in all the digits again. The LNR is repeatable after each off-hook.

The current content of the RAM is overwritten by new entries.

A manually entered number is automatically stored in the LNR RAM. The capacity of the RAM is 31 digits. If a number greater than 31 digits is entered, the LNR facility will be inhibited (until new entries < 32 digits) and further entries will be buffered in FIFO.

Pauses can be inserted by pressing the **PS** key (not AS2535).

Post dialed digits, i.e. digits manually entered after LNR has been invoked, are not stored in RAM but buffered in FIFO.

**Repeat Dialing (not AS2535)**

The last manually dialed number can be repeated without going on-hook by pressing the **RP** key. If a called number is engaged, pressing the **RP** key will break the line for 1.6 second (to get a new dial tone) and after a pause the number will be repeated.

The repeat function is enabled when prior to pressing the **RP** key, a number has been dialed, and it can be invoked an unlimited number of times until next on-hook. During the 1.6 second break the device is in power down mode to save current.

**Recall Function**

A recall (**R1**, **R2** or **R3** key) activation will invoke a flash (timed loop break), however, the **R1** flash is never executed in LD mode. **R2** and **R3** will be executed independent of the mode.

If recall is the first entry in a digit string, it will be stored in LNR RAM when digit(s) are entered after the recall.

If the recall key is depressed after a digit string has been entered or dialed out, the recall will not be stored but buffered in the FIFO together with subsequently entered digit.

If pressing the recall key is not followed by digit entries, the LNR RAM remains intact.

After a recall a 270 ms pause will automatically be

**Memory Keys (not AS2534)**

The keys **M1** to **M12** are direct memory access keys and the **MR** key (AS2533/36 only) is used for abbreviated dialing.

Memory arrangement	AS2533/36	AS2534	AS2535
Storable numbers	14	0	12
Direct memory keys	4	0	12
Indirect memories	10	0	0

In the on chip RAM, numbers can be stored. Each number can contain up to 21 digits (including pauses).

During programming multiple pauses can be inserted by pressing the **PS** (not AS2535) or the **LNR** key. Each pause inserted within the first 5 entries will automatically be terminated after 2 seconds whereas pauses inserted after location 5 in a digit string will halt dialing and can be terminated manually by pressing the **PS** (not AS2535) or the **LNR** key. The halt function allows in-dialing to an extension on a PABX.

Example (45678–123 is stored in M1, where – is a pause/wait and 123 the extension number):  
 off-hook, wait for dial tone  
 press **M1** (45678 is dialed out)  
 await dial tone from called PABX  
 press **PS** or **LNR** (123 is dialed out)

Memory dialing is cascadable. However, the content of one memory must be dialed out before a new can be invoked.

**Sliding Cursor Procedure**

To accommodate easy and uncomplicated redialing (LNR) behind a PABX, a sliding cursor protocol is implemented. If new entries match the previous RAM contents, pressing the **LNR** key will dial out the remaining digits.

If there is an error in matching, the LNR will be inhibited until next on-hook, and the RAM will contain the new number.

Example (LNR content 912345, where 9 is access code):  
 off-hook, wait for PABX dial tone  
 press 9 and wait for external dial tone  
 press **LNR** (12345 will be dialed out).

**Tone Generator**

The tone generator incorporates the DTMF tones, 3 basic frequencies for the tone ringer and pacifier tones.

**DTMF**

The DTMF generator provides 8 frequencies, namely:



## Low group

Digit 1-2-3-A	697 Hz
Digit 4-5-6-B	770 Hz
Digit 7-8-9-C	852 Hz
Digit * -0-# -D	941 Hz

## High group

Digit 1-4-7- *	1209 Hz
Digit 2-5-8-0	1336 Hz
Digit 3-6-9-#	1477 Hz
Digit A-B-C-D	1633 Hz (not AS2535)

The MF output level can be set with an external voltage divider on pin MFL.

Voltage at pin MFL (2)		DTMF Level (Low Grp.)
A <sub>GND</sub>	typ. 1.50* V	-4.0 dBm
0.878 * A <sub>GND</sub>	1.317 V	-5.2 dBm
0.791 * A <sub>GND</sub>	1.187 V	-6.4 dBm
0.705 * A <sub>GND</sub>	1.058 V	-7.6 dBm
0.620 * A <sub>GND</sub>	0.930 V	-8.8 dBm
0.495 * A <sub>GND</sub>	0.743 V	-10.0 dBm
0.372 * A <sub>GND</sub>	0.558 V	-11.2 dBm
0.290 * A <sub>GND</sub>	0.435 V	-12.4 dBm
0.210 * A <sub>GND</sub>	0.315 V	-13.6 dBm
0.130 * A <sub>GND</sub>	0.195 V	-14.8 dBm
V <sub>SS</sub>	0.000 V (V <sub>SS</sub> )	-16.0 dBm
(Z <sub>LINE</sub> = 600)		

\*typical MFL values for A<sub>GND</sub> = 1.5V

The preemphasis is 2.6 dB.

The MF tones are according to CEPT recommendations.

**Tone Ringer (Melody/Volume)**

The three basic frequencies of the melodies are:  
F1 = 800 Hz, F2 = 1067 Hz, and F3 = 1333 Hz (± 5%).

The repetition rate and the volume of the tone ringer melodies can be programmed by pressing **P/M** and **#** followed by a digit as follows:

Digit	Repetition Rate	Volume
1	1 time (50 ms pause)	- 16 dB
2	1 time (50 ms pause)	- 7 dB
3	1 time (50 ms pause)	0 dB (max.)
4	4 times	- 16 dB
5	4 times	- 7 dB
6	4 times (default, AS2534R)	0 dB (max.)
7	10 times	- 16 dB
8	10 times	- 7 dB
9	10 times	0 dB (max.)
0	None	Off

The procedure is ended by repressing the **P/M** key.

The default setting is digit 6, i.e. after a power on reset the device will start up with repetition rate 4 and maximum volume. If digit **0** is programmed, the tone ringer will be turned off until next off-hook where it will turn back to the last setting before 0. The programmed settings are stored in the on chip RAM.

Repetition rate means that a sequence of 6 frequencies is repeated 1, 4 or 10 times within 1 second.

The sequence of the frequencies is controlled by the sequence register as follows:

Sequence F1 F2 F3 F1 F2 F3 ...

**Pacifier Tone**

By MF dialing the DTMF tones are provided to the earpiece as comfort tone.

During programming a key entry is acknowledged by a pacifier tone of 1477 Hz. The level of the pacifier tone is approximately 60 mV at the RO output. The duration is 40 ms after every key entry in program mode.

When terminating the program mode with the **P/M** key an acknowledge tone of 140 ms is provided. An invalid key entry, however, will cause a termination of the program mode indicated by a rejection tone of 4 times 40 ms with 28 ms pauses between the tone bursts.

**Ring Frequency Discrimination**

The ring frequency discriminator assures that only signals with a frequency between 13Hz and 70 Hz are regarded as valid ring signals. The time for recognizing a valid ring signal is 1/f seconds, where 'f' is the ring frequency.

When a valid ring signal is present for 73 ms continuously, the melody generator is activated and remains active as long as the ring signal is present.

Once the melody generator has been started, the ring signal is continuously monitored and the melody generator is instantly turned on or off according to the momentary presence of a valid or invalid ring signal respectively (until next POR or off-hook).

### Typical Characteristics of Line Loss Compensation



Figure 6 Typical Tx Gain Characteristics Line Loss Compensation



Figure 7 Typical Rx Gain Characteristics Line Loss Compensation



## Programming Procedures

### Procedure Principles

The procedures for utilizing the features of the AS253x are optimized out of consideration for the human factor in order to:

- meet the user's expectations
- be easy to learn and relearn
- not invoke any automatic functions which the user doesn't expect
- protect the user from committing critical errors, e.g. dialing wrong numbers, deleting stored numbers, etc.
- be consistent, simple and usable.

The following chapters describe the operating procedures for the provided features. Pressing an invalid key or key combination during programming will cause the device to abort the program state. Pressing any key combination or sequence which is not described or defined may cause the device to enter a state or mode that does not comply with the expectation of the user. In such cases, any undesired state can be terminated at any time by going on-hook / off-hook which will generate a functional reset.

### Storing Numbers (not AS2534)

Up to 14 numbers, each with maximum 21 digits, can be stored into the internal RAM.

1. Press **[P/M]** to enter program mode
2. Enter location (MR + digit<sup>1</sup>; or M1 to M12)
3. Enter number - entries (0-9, \*, #, PS or LNR, R1, R2, R3) will be written directly into the selected memory location)
4. Press **[P/M]** to store and exit or go on-hook to abort
5. Go to 1 for storing further numbers

### Programming Tone Ringer

Three different ringer melodies with three levels each can be programmed. AS2534R cannot be programmed.

1. Press **[P/M]** to enter program mode
2. Press **[#]** for ringer programming mode
3. Enter **Code** to select ringer melody and volume (see code table in section Tone Ringer (Melody/Volume))
4. Press **[P/M]** to store and exit or go on-hook to abort

<sup>1</sup> Digit includes 0 – 9

When Code 0 (tone ringer off) has been programmed, the device will automatically return to previous setting (different from 0) by next off-hook.

### Temporary MF

The procedure below assumes that the device is operated in puls mode.

1. Go off-hook
2. Press **[\*]** or **[T/P]** to switch to DTMF mode
3. Press **[R]** or **[T/P]** to switch back to PULS mode
4. Got to 2. to switch again to DTMF mode

Mode pin is connected to row 1, 2, 3, 4, or 5. When mode pin = row 5, pressing the **[\*]** key also transmits the tone by MF selected. The **[T/P]** key (not AS2535) can be used alternatively to the **[\*]** key.

### Automatic Dialing

The following procedure describes the dialing procedure and the internal sequences:

1. Go off-hook
2. Enter the number by pressing digit, **[M1]-[M12]**, **[LNR]** or **[MR]** + digit
3. The number is internally buffed in the FIFO
4. Tone- or Puls-Dialing starts
5. Wait for connection
6. Got to 2 for entering postdialed digits

Postdialed digits are not stored but buffed in the FIFO.

## Timing Diagrams

### LD Dialing

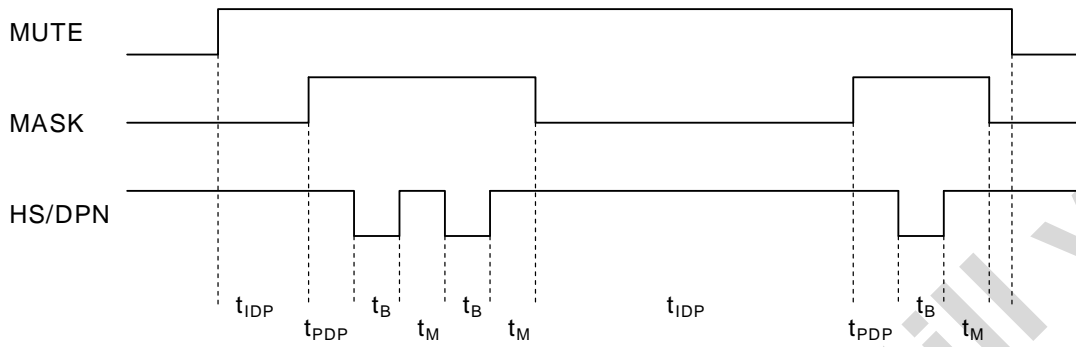

### LD Dialing with Access Pause

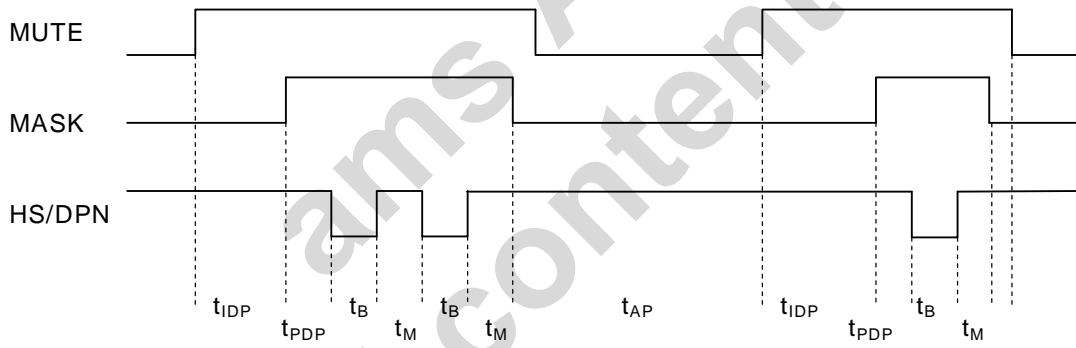

### MF Dialing



**Flash**

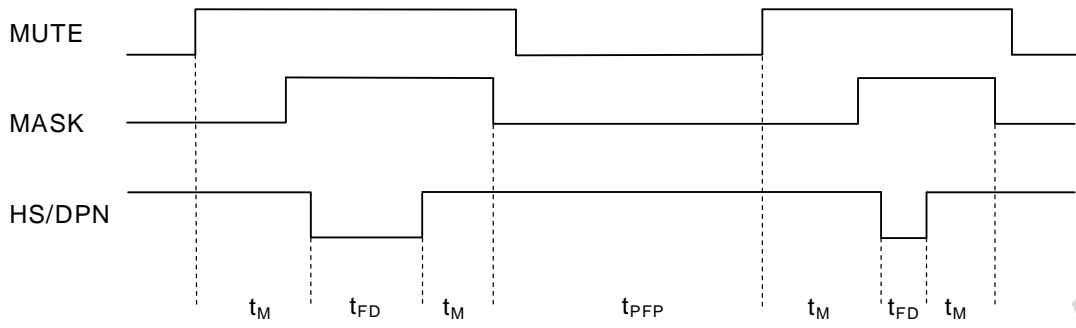

**Repeat Dialing (not AS2535)**

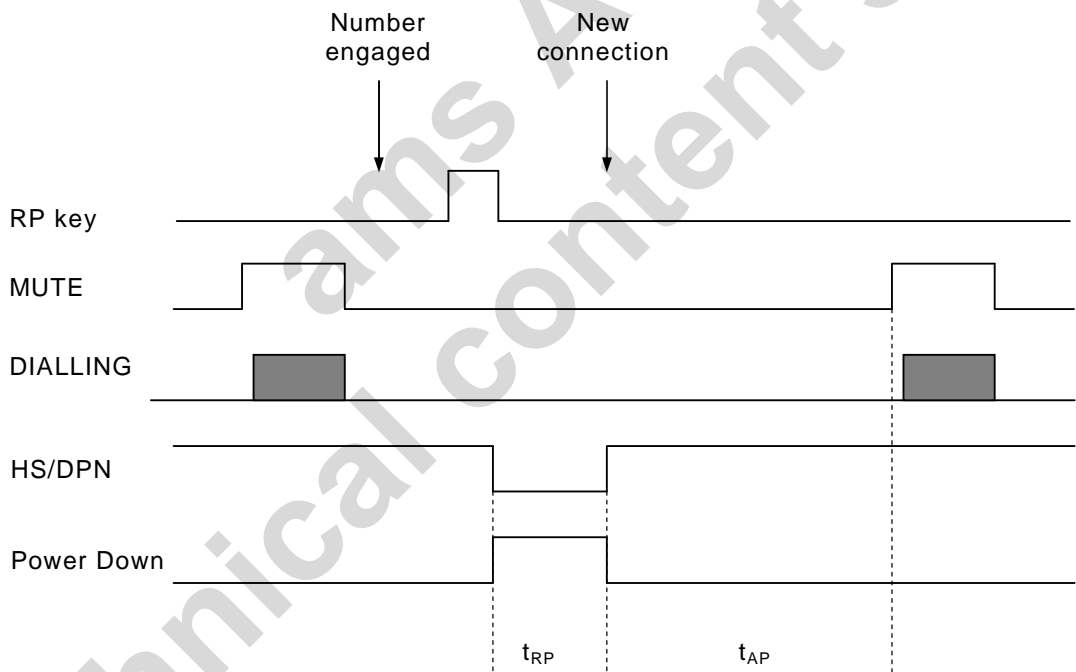

## Electrical Characteristics

### Absolute maximum ratings

Positive Supply Voltage	$-0.3V \leq V_{DD} \leq 7V$
Input Current	$\pm 25mA$
Input Voltage (LS)	$-0.3V \leq V_{IN} \leq 10V$
Input Voltage (LI, CS)	$-0.3V \leq V_{IN} \leq 8V$
Input Voltage (STB, RI)	$-2V \leq V_{IN} \leq V_{DD}+0.3V$
Input Voltage (MO)	$-0.3V \leq V_{IN} \leq +35V$
Digital Input Voltage	$-0.3V \leq V_{IN} \leq V_{DD}+0.3V$
Electrostatic Discharge (HBM 1.5k $\Omega$ -100pF)	$\pm 1000V$
Storage Temperature	$-65^{\circ}C$ to $+125^{\circ}C$

### Recommended operating conditions

Supply Voltage * (Speech Mode)	$3.8V \leq V_{DD} \leq 5V$
Oscillator Frequency (Resonator: Murata CSA 3.58M G312AM)	3.58 MHz
Operating Temperature	$-25^{\circ}C$ to $+70^{\circ}C$

\* This voltage is generated internally

### DC Characteristics ( $I_{LINE} = 15\text{ mA}$ unless otherwise specified)

Symbol	Parameter	Conditions	Min.	Typ.	Max.	Units
$I_{DD}$	Operating Current	Speech mode		3	5	mA
		MF dialing		4		mA
		LD dialing, $V_{DD} = 2.5V$		200		$\mu A$
		Ring mode, $V_{DD} = 2.5V$		300		$\mu A$
$I_{DD0}$	Retention Current	Idle mode, $V_{DD} = 2\text{ V}$ , $T_{AMB} = 25^{\circ}C$		0.05		$\mu A$
$V_{LI}$	Line Voltage (default)	$13\text{ mA} \leq I_{LINE} \leq 100\text{ mA}$		4.5		V
$I_{OL}$	Output Current, Sink CS, HS/DP, MO	$V_{OL} = 0.4V$		1.5		mA
$I_{OL}$	Output Current, Sink; LED	$V_{OL} = 0.4V$		4		mA
$V_{IL}$	Input Low Voltage	HS/DPN; FCI $T_{AMB} = 25^{\circ}C$	$V_{SS}$		$0.3 V_{DD}$	V
$V_{IH}$	Input High Voltage	HS/DPN; FCI $T_{AMB} = 25^{\circ}C$	$0.7 V_{DD}$		$V_{DD}$	V

**AC Characteristics** (I LINE = 15 mA; f = 800 Hz unless otherwise specified)

Symbol	Parameter	Conditions	Min	Typ	Max	Units
<b>Tx</b>	<b>Transmit</b>	<b>Test Circuit Figure 9</b>				
A <sub>TX</sub>	Gain, Transmit	M1/M2 to LI	35.1	36.6	38.1	dB
ΔA <sub>TX/F</sub>	Variation with Frequency	f = 500 Hz to 3.4 kHz		±0.8		dB
THD	Distortion	V <sub>LI</sub> ≤ 0.25V <sub>RMS</sub>			2	%
V <sub>AGC</sub>	Soft Clip Level			2		V <sub>PEAK</sub>
A <sub>SCO</sub>	Soft Clip Overdrive			20		dB
t <sub>ATTACK</sub>	Attack Time			30		μs/6 dB
t <sub>DECAY</sub>	Decay Time			20		ms/6dB
Z <sub>IN</sub>	Input Impedance (M1/M2)			20		kΩ
A <sub>MUTE</sub>	Mute Attenuation	Mute activated		60		dB
V <sub>NO</sub>	Noise Output Voltage	T <sub>AMB</sub> = 25°C			-72	dBmp
V <sub>IN Max</sub>	Input Voltage Range (M1/M2)	Differential Single Ended		±1 ±0.5		V <sub>PEAK</sub> V <sub>PEAK</sub>
<b>BJT</b>	<b>Output Driver</b>					
V <sub>IN MAX</sub>	Input Voltage Range (LI)			±2		V <sub>PEAK</sub>
V <sub>TX</sub>	Dynamic Range			±2		V <sub>PEAK</sub>
RL	Return Loss	Z <sub>RL</sub> = 1000Ω; T <sub>AMB</sub> = 25°C	18			dB
ΔZ <sub>AC/TEMP</sub>	Temperature Variation			0.5		Ω/°C
<b>Rx</b>	<b>Receive</b>	<b>Test Circuit Figure 9</b>				
A <sub>RX</sub>	Receive Gain (Vol. default)	LI to RO	1.5	3	4.5	dB
A <sub>VOL</sub>	Volume Gain	<b>VOL</b> key		+5.4		dB
A <sub>VOL</sub>	Volume Gain	<b>-/+</b> keys		-5.4/+8.1		dB
ΔA <sub>RX/F</sub>	Variation with Frequency	f = 500 Hz to 3.4 kHz		±0.8		dB
THD	Distortion	V <sub>RI</sub> ≤ 0.25V <sub>RMS</sub>			2	%
V <sub>AGC</sub>	Soft Clip Level	V <sub>RO</sub> =		1		V <sub>PEAK</sub>
A <sub>SCO</sub>	Soft Clip Overdrive			10		dB
t <sub>ATTACT</sub>	Attack Time	V <sub>RI</sub> > 0.8V <sub>RMS</sub>		30		μs/6 dB
t <sub>DECAY</sub>	Decay Time			20		ms/6dB
V <sub>NO</sub>	Noise Output Voltage	T <sub>AMB</sub> = 25°C			-72	dBmp
V <sub>UFC</sub>	Unwanted F. Components	50 Hz....20 kHz			-60	dBm
Z <sub>IN</sub>	Input Impedance (RI)			8		kΩ
V <sub>IN RI</sub>	Input Voltage Range (RI)			±2		V <sub>PEAK</sub>
A <sub>ST</sub>	Sidetone Cancellation	V <sub>RI</sub> ≤ 0.25V <sub>RMS</sub>	26			dB
V <sub>IN ST</sub>	Input Voltage Range (STB)			±2		V <sub>PEAK</sub>
Z <sub>IN</sub>	Input Impedance (STB)			80		kΩ



**AC Characteristics (cont'd)** ( $I_{LINE} = 15 \text{ mA}$ ;  $f = 800 \text{ Hz}$  unless otherwise specified)

Symbol	Parameter	Conditions	Min	Typ	Max	Units
$t_D$	<b>Keyboard</b> Key Debounce Time			15		ms
$t_{HS-L}$	<b>HS/DPN Input</b> Low to High Debounce	Going off-hook		15		ms
$t_{HS-H}$	High to Low Debounce	Not LD dialing		210		ms
		During LD dialing		270		ms
F	<b>DTMF</b> Frequency deviation	$T_{AMB} = 25^\circ\text{C}$ , Note 5			1.2	%
$V_{MF}$	MF Tone Level (Low group)	$MFL = A_{GND}$ , $T_{AMB} = 25^\circ\text{C}$	- 2.5	- 4	- 5.5	dB
$V_{MF}$	MF Tone Level (Low group)	$MFL \text{ Range} = V_{SS} \dots A_{GND}$ , $T_{AMB} = 25^\circ\text{C}$		-16...-4		dB
$\Delta V_{L-H}$	Preemphasis Low to High	$T_{AMB} = 25^\circ\text{C}$ ,	1.8	2.4	3.0	dB
$V_{UFC}$	Unwanted F. Components Note 3; $MFL = V_{SS}$	300 Hz...5 kHz			- 40	dBm
		5 kHz...14 kHz			- 50	dBm
		14 kHz...28.5 kHz			- 70	dBm
		28.5 kHz...40 kHz			- 80	dBm
$t_{TD}$	Tone Duration	Note 1&6; Mode=row 6 or 7	80	82.3	85	ms
$t_{TP}$	Inter Tone Pause	Note1; Mode=row 6	80	82.3	85	ms
$t_{TP}$	Inter Tone Pause	Note 1 & 6; Mode=row 7	150	165	170	ms
$t_{TR}$	Tone Rise Time	Note 2			5	ms
$t_{TF}$	Tone Fall Time	Note 2			5	ms
$t_{DR}$	<b>LD</b> Dial Rate	Mode = row 1, 2 or 5	9.53	10	10.5	pps
		Mode = row 3 or 4	19.05	20	21	pps
$t_B$	Break Period	Mode = row 2	57	61.2	63	ms
$t_B$	Break Period	Mode = row 4	28.5	30.6	31.5	ms
$t_B$	Break Period	Mode = row 1 or 5	63	66	69	ms
$t_B$	Break Period	Mode = row 3	31.5	33	34.5	ms
$t_M$	Make Period	Mode = row 2	38	40.8	42	ms
$t_M$	Make Period	Mode = row 4	19	20.4	21	ms
$t_M$	Make Period	Mode = row 1 or 5	31.5	33	34.5	ms
$t_M$	Make Period	Mode = row 3	15.7	16.5	17.3	ms
$t_{PDP}$	Pre-Digit Pause			35		ms
$t_{IDP}$	Inter Digit Pause	Mode = row 1, 2, 3, 4 or 5 $f_{osc} = 3.58 \text{ MHz}$	780	790	800	ms
$t_{HS-H}$	High to Low Debounce	During LD dialing		270		ms
$t_{MO}$	Mute Overhang			$t_M$		

Symbol	Parameter	Conditions	Min	Typ	Max	Units
t <sub>FD</sub>	Flash Duration 1	R1 key	100		102	ms
	Flash Duration 2	R2 key	270		300	ms
	Flash Duration 3	R3 key (AS2533/34/35/36)	600		650	ms
t <sub>FFP</sub>	Post Flash Pause			274		ms
t <sub>AP</sub>	Access Pause	Note 8	2.0	2.05	2.12	sec
t <sub>RP</sub>	Repeat Break Time			1.6		sec
V <sub>MO</sub>	<b>Tone Ringer</b> Melody Output			PDM		
t <sub>MD</sub>	Melody Delay				10	ms
F1	Frequency 1			800		Hz
F2	Frequency 2			1067		Hz
F3	Frequency 3			1333		Hz
t <sub>DT</sub>	Detection Time	Initial		1/f + 73ms		s
t <sub>TO</sub>	Detection Time-out			note 4		ms
f <sub>MIN</sub>	Min. Detection Frequency			13		Hz
f <sub>MAX</sub>	Max. Detection Frequency			70		Hz
f <sub>PT</sub>	<b>Pacifier Tone</b> Frequency	Program Mode Only P/M mode, key entry		1477		Hz
V <sub>RT</sub>	Level (RO)	Key entry		60		mV
t <sub>RTD-E</sub>	Duration, Key Entry	Valid key entry, prog.		40		ms
t <sub>RTD-A</sub>	Duration, Acknowledge	Terminate with P/M key		140		ms
t <sub>RTD-R</sub>	Duration, Reject	Invalid key entry, note 7		4x40		ms
t <sub>LED-ON</sub>	<b>LED Output</b> "on-time"	P/M state		80		ms
t <sub>LED-OFF</sub>	Interval	P/M state		1		sec
V <sub>CT</sub>	<b>Comfort Tone (DTMF)</b> Level (RO)	Relative to LS		-30		dBr

Note 1: The values are valid during automatic dialing and are minimum values during manual dialing, i.e. the tones will continue as long as the key is depressed.

Note 2: The rise time is the time from 10% of final value till the tone amplitude has reached 90 % of its final value.

Note 3: Relative to high group.

Note 4: The FCI circuit is reset by POR and HS/DPN pulled high (off-hook). After a reset the FCI circuit is in a standby state. A positive edge on FCI will start a 73 ms timer and the frequency discrimination is initiated. Whenever a period of the ring signal is missing, the timer is reset. When a valid ring signal is present for 73 ms, the melody generator is started and is directly controlled by the ring signal. This condition will remain until a new reset.

Note 5: This does not include the frequency deviation of the ceramic resonator.

Note 6: During temporary MF mode.

Note 7: An invalid key entry in program mode will invoke a tone sequence with 4 tone bursts of 40 ms and pauses between bursts of 28 ms and abort the program mode.

Note 8: Pauses inserted within the first 5 entries of a digit string will be automatically terminated after 2 seconds. Pauses inserted after location 5 can only be terminated manually by pressing the PS or LNR key.

### Test Circuit



Figure 9 Test Circuit

### Characteristic Curves (Typical)



Figure 10 Receive Soft Clipping and Distortion

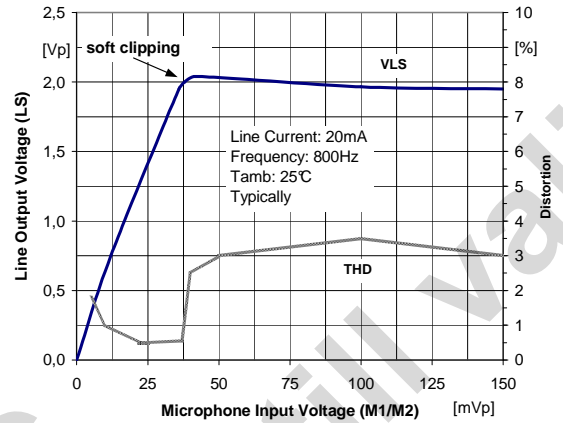

Figure 11 Transmit Soft Clipping and Distortion



Figure 12 DC Mask

### Bond Pad Layout



### Bond Options

Product Version	Bond Pad	Connection
AS2533	BOND_AS2535 BOND_AS2536	not bonded not bonded
AS2534/34R <sup>(1)</sup>	BOND_AS2535 BOND_AS2536	not bonded bonded to MODE
AS2535	BOND_AS2535 BOND_AS2536	bonded to MODE not bonded
AS2536	BOND_AS2535 BOND_AS2536	not bonded bonded to MODE

<sup>(1)</sup> For deliveries as packaged devices (SOIC28), LNR only is tested, direct and indirect memories are not tested!

## Sizes and Coordinates

Die Size: 3.190mm x 2.975mm  
 Bond Pad Size: 85µm x 85µm  
 Bond Pad Co-ordinates: Reference co-ordinate of DIE = DIE center  
 Reference co-ordinate of PAD = PAD center

X [µm]	y [µm]	Pad Name	Pin No
<b>Pads on the Left</b>			
-1413.50	1052.25	VDD	4
-1413.50	796.25	AGND	5
-1413.50	586.25	STB	6
-1413.50	226.25	CI	7
-1392.50	-107.75	MO	8
-1392.50	-399.35	LLC	9
-1392.50	-974.20	HS/DP	10
<b>Pads on the Bottom</b>			
-1244.00	-1285.00	OSC	11
-862.10	-1285.00	BOND_AS2535	
-696.70	-1285.00	MODE	12
-432.50	-1285.00	BOND_AS2536	
-215.10	-1285.00	C4	13
-49.70	-1285.00	C3	14
214.50	-1285.00	C2	15
379.90	-1285.00	C1	16
677.30	-1285.00	R4	17
842.70	-1285.00	R3	18
1173.30	-1285.00	R2	19

x [µm]	y [µm]	Pad Name	Pin No
<b>Pads on the Right</b>			
1392.50	-1053.80	R1	20
1392.50	-663.00	FCI	21
1392.50	-319.80	LED	22
1413.50	408.75	M1	23
1413.50	683.75	M2	24
<b>Pads on the Top</b>			
1227.50	1301.25	CS	25
1079.50	1301.25	VSS	26
969.50	1301.25	VSS	26
627.50	1301.25	LI	27
54.50	1301.25	RI	28
-90.50	1301.25	LS	1
-449.50	1301.25	MFL	2
-744.50	1301.25	RO	3

## Vertical Structure of Bond Pads

Process CXQ/CXB – FAB B



Layer Specification	
metal 2	upper layer: <b>960 nm AlSiCu</b> 98.5% Aluminium 1.0% Silicon 0.5 % Copper lower layer: <b>40 nm Titanium</b>
metal 1	upper layer: <b>450 nm AlSiCu</b> 98.5 % Aluminium 1.0% Silicon 0.5 % Copper lower layer: <b>40 nm Titanium</b>
metal 1 barrier	upper layer 80nm Titanium Nitride lower layer 30nm Titanium
polysilicon	270 nm polysilicon
oxide	460 nm thermal oxide
silicon substrate	

General Conditions	
Passivation	200 nm silicon oxynitride + 550 nm silicon nitride
Marking of Failure Dice	Ink Dots, water resistant, Diameter 0.4...1.2 mm
Allowed Loss after Assembly	< 5% in average < 10% for a single delivery lot Compensation is limited to replacement of the number of defectives exceeding the above allowances.
Quantity of dice per delivery lot	Only complete wafers can be delivered, therefore the number of good dice delivered may differ from the order quantity up to $\pm 1000$ pcs.
Storage Conditions	Dice on wafer or dice on foil must be stored in originally sealed boxes or bags. For storage period - see below. Except for RMA, opened boxes or bags will not be accepted by <i>austriamicrosystems</i> for return

Conditions for Delivery as Wafer	
Wafer diameter	200 mm (ams-FAB-B) or 150 mm (XFAB)
Wafer thickness	$380 \pm 20 \mu\text{m}$ (ams-FAB-B) or $640 \pm 20 \mu\text{m}$ (XFAB)
Back finishing	back grinding, silicon
Scribe lane width	$100 \pm 20 \mu\text{m}$
Packing	Wafer Box Ultrapack 200 / sealed in foil bags
Max. Storage time in sealed box	6 month, $T_{amb} = 25^\circ \text{C}$

Conditions for Delivery as Dice on Foil, sawn	
Die thickness	380 ± 20µm
Back finishing	back grinding, silicon
Frame	Material: Plastic Size: see figure
Frame Position Tolerance	Center wafer to frame: ± 4mm Angle deviation wafer to frame: ± 8° Orientation wafer to frame: Wafer flat to frame side with kerfs Covering adhesive foil to frame: >5mm
Tape	Type: PVC with acrylic adhesive Thickness: 70 ± 20 µm
Sawing conditions	Sawing mode: Saw - through mode Sawing width: typ. 60 µm Kerf depth in foil: typ. 20 µm XV -dimension deviation: max.25 µm
Packing	frame sealed in foil bags filled with nitrogen
Storage time In sealed bags	2 months, Tamb = 25 °C

**Mechanical Drawing of Frame (valid for 200 mm and 150 mm wafer)**





## Packaging

The device is available in the packages outlined below (not to scale). For exact mechanical package dimensions please see austriamicrosystems<sup>AG</sup> packaging information.

28-pin plastic SOIC (suffix T)



Max. Body Length 18.1mm / 713mil  
 Max. Body Width 7.6mm / 300mil  
 Pitch 1.27mm / 50mil

## Pin Configuration

28 Pin SOIC (suffix T)

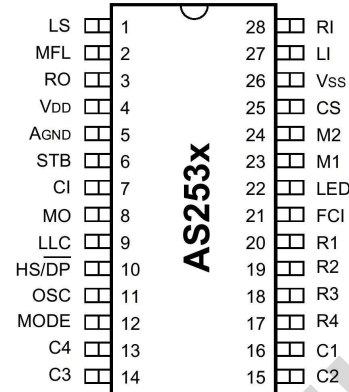

## Ordering Information

Device	Order Number	Package	Features
AS2533 T	AS2533U-ZSO-U	28 pin SOIC in tubes	LNR, 4 direct/10 indirect memories
AS2533 F	pls see bottom rows	Dice on foil, sawn	LNR, 4 direct/10 indirect memories
AS2533 W	pls see bottom rows	Dice on wafer	LNR, 4 direct/10 indirect memories
AS2534B T	AS2534U-ZSO-U	28 pin SOIC in tubes	LNR only, no direct/indirect memories <sup>(2)</sup>
AS2534B F	pls see bottom rows	Dice on Foil, sawn	LNR only, no direct/indirect memories
AS2534B W	pls see bottom rows	Dice on Wafer	LNR only, no direct/indirect memories
AS2534R T	AS2534R-ZSO-U	28 pin SOIC in tubes	LNR only, no direct/indirect memories, ringer fixed <sup>(2)</sup>
AS2534R F	pls see bottom rows	Dice on Foil, sawn	LNR only, no direct/indirect memories, ringer fixed
AS2534R W	pls see bottom rows	Dice on Wafer	LNR only, no direct/indirect memories, ringer fixed
AS2535 T	AS2535U-ZSO-U	28 pin SOIC	LNR, 12 direct memories
AS2535 F	pls see bottom rows	Dice on Foil, sawn	LNR, 12 direct
AS2535 W	pls see bottom rows	Dice on Wafer	LNR, 12 direct
AS2536 T	AS2535U-ZSO-U	28 pin SOIC	LNR, 4 direct/10 indirect memories
AS2536 F	pls see bottom rows	Dice on Foil, sawn	LNR, 4 direct/10 indirect memories
AS2536 W	pls see bottom rows	Dice on Wafer	LNR, 4 direct/10 indirect memories
AS253x F	AS253xU-ZSW-F	Dice on Foil, sawn	All versions <sup>(1)</sup>
AS253x W	AS253xU-ZSW	Dice on Wafer	All versions <sup>(1)</sup>
AS253xR F	AS253xR-ZSW-F	Dice on Foil, sawn	All versions, ringer fixed <sup>(1)</sup>
AS253xR W	AS253xR-ZSW	Dice on Wafer	All versions, ringer fixed <sup>(1)</sup>

### Please Note:

<sup>(1)</sup> For wafer delivery or dice-on-foil delivery, the versions can be selected by bond options.

<sup>(2)</sup> For deliveries as packaged devices (SOIC28), LNR only is tested, direct and indirect memories are not tested!

## Contact Information

austriamicrosystems AG  
Business Unit Communications  
A 8141 Schloss Premstaetten, Austria-EU  
T. +43 (0) 3136 500 0  
F. +43 (0) 3136 500 5692  
<http://www.austriamicrosystems.com>

For Sales Offices, Distributors and Representatives, please visit:

<http://www.austriamicrosystems.com/contact>

## Copyright

Copyright © 1997-2006, austriamicrosystems AG, Schloss Premstaetten, 8141 Unterpremstaetten, Austria-Europe. Trademarks Registered ®. All rights reserved. The material herein may not be reproduced, adapted, merged, translated, stored, or used without the prior written consent of the copyright owner.

All products and companies mentioned are trademarks of their respective companies.

## Disclaimer

Devices sold by austriamicrosystems AG are covered by the warranty and patent indemnification provisions appearing in its Term of Sale. austriamicrosystems AG makes no warranty, express, statutory, implied, or by description regarding the information set forth herein or regarding the freedom of the described devices from patent infringement. austriamicrosystems AG reserves the right to change specifications and prices at any time and without notice. Therefore, prior to designing this product into a system, it is necessary to check with austriamicrosystems AG for current information. This product is intended for use in normal commercial applications. Applications requiring extended temperature range, unusual environmental requirements, or high reliability applications, such as military, medical life-support or life-sustaining equipment are specifically not recommended without additional processing by austriamicrosystems AG for each application.

The information furnished here by austriamicrosystems AG is believed to be correct and accurate. However, austriamicrosystems AG shall not be liable to recipient or any third party for any damages, including but not limited to personal injury, property damage, loss of profits, loss of use, interruption of business or indirect, special, incidental or consequential damages, of any kind, in connection with or arising out of the furnishing, performance or use of the technical data herein. No obligation or liability to recipient or any third party shall arise or flow out of austriamicrosystems AG rendering of technical or other services.

***austriamicrosystems*** – a leap ahead

Компания «Океан Электроники» предлагает заключение долгосрочных отношений при поставках импортных электронных компонентов на взаимовыгодных условиях!

Наши преимущества:

- Поставка оригинальных импортных электронных компонентов напрямую с производств Америки, Европы и Азии, а так же с крупнейших складов мира;
- Широкая линейка поставок активных и пассивных импортных электронных компонентов (более 30 млн. наименований);
- Поставка сложных, дефицитных, либо снятых с производства позиций;
- Оперативные сроки поставки под заказ (от 5 рабочих дней);
- Экспресс доставка в любую точку России;
- Помощь Конструкторского Отдела и консультации квалифицированных инженеров;
- Техническая поддержка проекта, помощь в подборе аналогов, поставка прототипов;
- Поставка электронных компонентов под контролем ВП;
- Система менеджмента качества сертифицирована по Международному стандарту ISO 9001;
- При необходимости вся продукция военного и аэрокосмического назначения проходит испытания и сертификацию в лаборатории (по согласованию с заказчиком);
- Поставка специализированных компонентов военного и аэрокосмического уровня качества (Xilinx, Altera, Analog Devices, Intersil, Interpoint, Microsemi, Actel, Aeroflex, Peregrine, VPT, Syfer, Eurofarad, Texas Instruments, MS Kennedy, Miteq, Cobham, E2V, MA-COM, Hittite, Mini-Circuits, General Dynamics и др.);

Компания «Океан Электроники» является официальным дистрибьютором и эксклюзивным представителем в России одного из крупнейших производителей разъемов военного и аэрокосмического назначения «JONHON», а так же официальным дистрибьютором и эксклюзивным представителем в России производителя высокотехнологичных и надежных решений для передачи СВЧ сигналов «FORSTAR».



## JONHON

«JONHON» (основан в 1970 г.)

Разъемы специального, военного и аэрокосмического назначения:

(Применяются в военной, авиационной, аэрокосмической, морской, железнодорожной, горно- и нефтедобывающей отраслях промышленности)

«FORSTAR» (основан в 1998 г.)

ВЧ соединители, коаксиальные кабели, кабельные сборки и микроволновые компоненты:

(Применяются в телекоммуникациях гражданского и специального назначения, в средствах связи, РЛС, а так же военной, авиационной и аэрокосмической отраслях промышленности).



Телефон: 8 (812) 309-75-97 (многоканальный)

Факс: 8 (812) 320-03-32

Электронная почта: [ocean@oceanchips.ru](mailto:ocean@oceanchips.ru)

Web: <http://oceanchips.ru/>

Адрес: 198099, г. Санкт-Петербург, ул. Калинина, д. 2, корп. 4, лит. А