

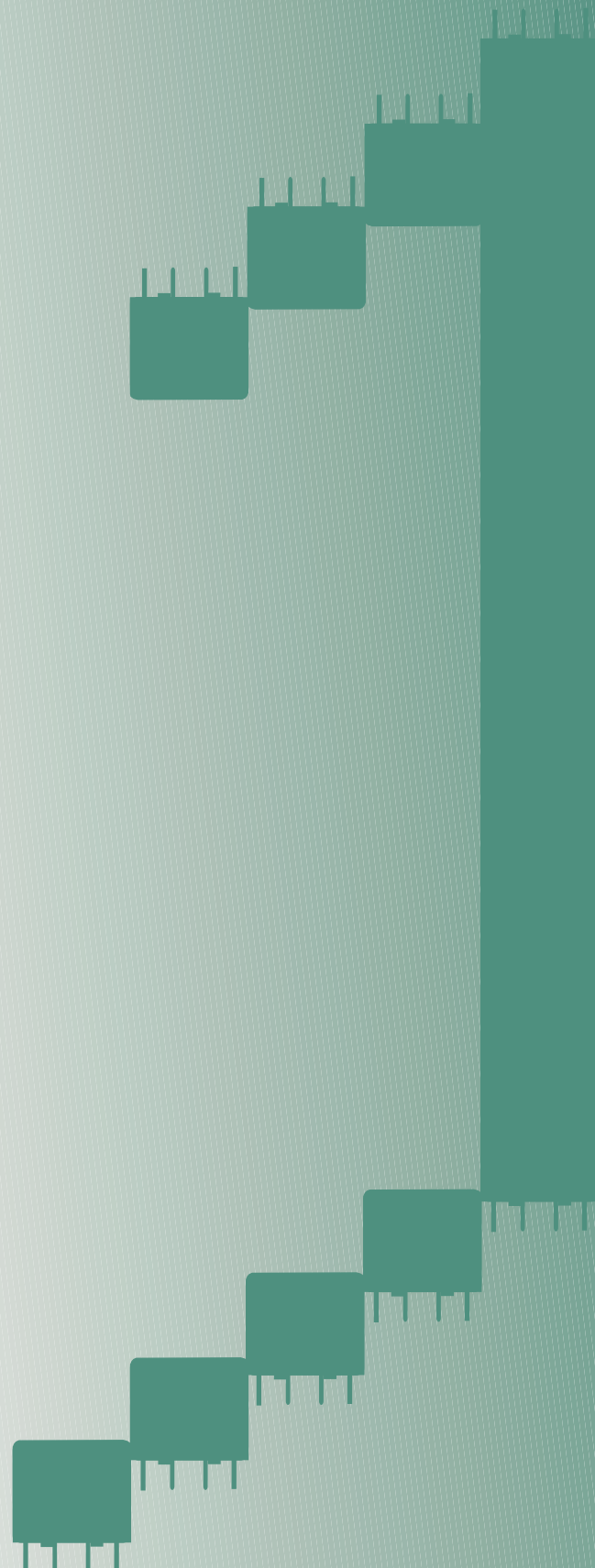

Magnecraft & Struthers-Dunn
Your Contact for Relays

SECTION 7

**PRINTED CIRCUIT BOARD RELAYS
1 TO 30 AMPERES**



PRINTED CIRCUIT BOARD RELAYS

RELAY SERIES

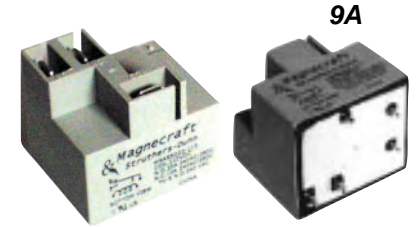

FEATURES

	L W H 0.905 x 0.728 x 1.275	L W H 1.30 x 1.08 x 0.805	L W H 1.27 x 1.08 x 1.10
<ul style="list-style-type: none"> ● MINIATURE SIZE ● ENCLOSED SEE THRU COVER WITH PRINTED CIRCUIT TERMINALS ● AC OR DC OPERATION ● 5 AMP RESISTIVE OR 3 AMP INDUCTIVE SWITCHING 	<ul style="list-style-type: none"> ● EPOXY SEALED IMMERSION CLEANABLE ● STANDARD 0.1 GRID PATTERN ● CLASS "B" OR "F" INSULATION SYSTEM ● MEETS UL 508 & UL 873 SPACING 	<ul style="list-style-type: none"> ● EPOXY SEALED IMMERSION CLEANABLE WITH TAPE SEAL ● CLASS "F" INSULATION SYSTEM ● SPADE TERMINALS ACCEPT INSULATED 1/4" QUICK CONNECT TERMINALS & 3/16" COIL QUICK CONNECT TERMINALS ● SEE SECTION 1 FOR FLANGE MOUNT STYLE WITH 1/4" & 3/16" QUICK CONNECT TERMINALS 	

CONTACT DATA

CONTACT CONFIGURATION:	DPDT	SPST-NO. & SPDT	SPST-NO. & SPDT
CONTACT MATERIAL:	SILVER CADMIUM OXIDE	SILVER CADMIUM OXIDE	SILVER CADMIUM OXIDE

MAX. CONTACT RATING:	3 AMP, 120 VAC., 5 AMP, 120 VAC., 30 VDC	SPST-NO: 30AMP, 240 VAC, 20AMP, 30 VDC SPDT: 20 AMP, 250 VAC (NO), 15 AMP, 240 VAC (NC), 10AMP, 30 VDC	SPST-NO: 30AMP, 240 VAC, 20AMP, 28 VDC SPDT: 30 AMP, 240 VAC, 20AMP, 28 VDC (NO), 15AMP, 240 VAC, 10AMP, 28 VDC (NC),
----------------------	---	---	---

COIL DATA

STANDARD VOLTAGE AC: DC:	24 & 120 VAC 12 & 24 VDC	5, 12, 24 & 110 VDC	5, 12, 24, 48 & 110 VDC
--------------------------------	-----------------------------	---------------------	-------------------------

NOMINAL COIL POWER VA: (VAC) WATTS: (VDC) INSULATION SYSTEM PER	1.2 VA 1.2 WATTS	- 2.8 WATTS MAX.	0.95 VA 2.8 WATTS MAX
--	---------------------	---------------------	--------------------------

GENERAL DATA

AMBIENT TEMPERATURE OPERATING:	- 45°C TO +70°C	- 55°C TO +105°C	- 55°C TO +85°C
STORAGE:		- 55°C TO +130°C	- 55°C TO +130°C
DIELECTRIC STRENGTH: (COIL TO FRAME)	1500 V rms	1500 V rms	2500 V rms

LIFE EXPECTANCY ELECTRICAL: MECHANICAL:	100,000 OPERATIONS AC: 50,000,000 & DC:100,000,000 OPERATIONS	100,000 OPERATIONS 10,000,000 OPERATIONS	100,000 OPERATIONS 10,000,000 OPERATIONS
---	---	---	---

AGENCY APPROVALS









PAGE NUMBER

PAGE 4

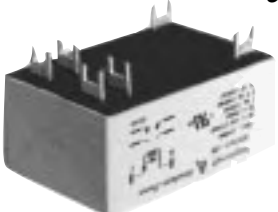
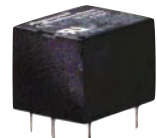
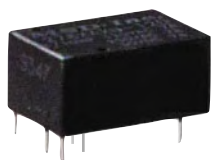
PAGE 5 - 6

PAGE 7 - 8

PRINTED CIRCUIT BOARD RELAYS

 <p>92</p>	 <p>7</p>	 <p>60</p>	 <p>A178</p>
<p>L W H 2.06 x 1.36 x 1.356</p>	<p>L W H 0.410 x 0.410 x 0.553</p>	<p>L W H 1.10 x 0.600/0.895 x 0.745</p>	<p>L W H 0.750 x 0.611 x 0.630</p>
<ul style="list-style-type: none"> EPOXY SEALED IMMERSION CLEANABLE WITH TAPE SEAL CLASS "F" INSULATION SYSTEM SEE SECTION 1 FOR FLANGE MOUNT STYLE WITH 1/4" & 3/16" QUICK CONNECT TERMINALS 	<ul style="list-style-type: none"> MICRO MINIATURE SIZE CONFORMS TO FCC PART 68.302, 1500V SURGERESISTANCE, FCC 68.3041000V DIELECTRIC STRENGTH EXCELLENT R.F. SWITCHING CHARACTERISTICS HIGH SHOCK & VIBRATION RESISTANCE PRINTED CIRCUIT BOARD MOUNTING ON 0.1 GRID PATTERN 94V-0 PLASTIC, EPOXY SEALED 	<ul style="list-style-type: none"> MINIATURE SIZE CONFORMS TO FCC PART 68.302, 1500V SURGE RESISTANCE, FCC 68.3041000V DIELECTRIC STRENGTH EXCELLENT R.F. SWITCHING CHARACTERISTICS HIGH SHOCK & VIBRATION RESISTANCE PRINTED CIRCUIT BOARD MOUNTING ON 0.1 GRID PATTERN 	<ul style="list-style-type: none"> MINIATURE EPOXY SEALED PRINTED CIRCUIT BOARD MOUNTING SWITCHES UP TO 15 AMP LOADS CLASS "B" OR "F" INSULATION SYSTEM IMMERSION CLEANABLE DISPLACES APPROXIMATELY 0.29 CUBIC INCH
<p>DPST-NO. & DPDT</p>	<p>SPDT & DPDT</p>	<p>SPDT & DPDT</p>	<p>SPST</p>
<p>SILVER CADMIUM OXIDE</p>	<p>GOLD CLAD SILVER</p>	<p>GOLD CLAD SILVER</p>	<p>SILVER ALLOY</p>
<p>DPDT-NO: 30A, 277 VAC. 20A, 28 VDC DPST-NO: 30A, 277 VAC. 20A, 28 VDC DPDT-NC: 3A, 277 VAC, 28 VDC</p>	<p>DPDT: 2 AMP, 24 VDC, 0.6AMP, 100 VAC SPDT: 2 AMP, 120 VAC, 50 uA, 50 mV MIN 2 AMP, 24 VDC</p>	<p>DPDT: 2 AMP, 24 VDC, 1 AMP, 100 VAC SPDT: 2 AMP, 120 VAC 50 uA, 50 mV MIN</p>	<p>12 AMP, 120 VAC, 30 VDC 10 AMP, 150 VAC</p>
<p>24, 120 & 240 VAC 12, 24, 48 & 110 VDC</p>	<p>5, 12, & 24 VDC</p>	<p>5, 12, & 24 VDC</p>	<p>3, 5, 12, 24 & 48 VDC</p>
<p>4 VA 1.7 WATTS</p>	<p>- 327 MILLIWATTS MAX</p>	<p>- 327 MILLIWATTS MAX</p>	<p>- 0.36 WATTS</p>
<p>DC: - 40°C TO +85°C AC: - 40°C TO +65°C - 55°C to +155°C</p>	<p>- 35°C TO +70°C</p>	<p>- 35°C TO +70°C</p>	<p>- 40°C TO +70°C - 40°C TO +80°C</p>
<p>4000 V rms</p>	<p>500 V rms</p>	<p>500 V rms</p>	<p>1500 V rms</p>
<p>5,000,000 OPERATIONS 100,000 OPERATIONS</p>	<p>100,000,000 OPERATIONS 100,000 OPERATIONS</p>	<p>100,000,000 OPERATIONS 100,000 OPERATIONS</p>	<p>100,000 OPERATIONS 10,000,000 OPERATIONS</p>
 UL Recognized File No. E43641	 UL Recognized File No. E52197	 UL Recognized File No. E52197	 UL Recognized File No. E195668

PRINTED CIRCUIT BOARD RELAYS

RELAY SERIES



49

ISO 9002
QS 9000



976

ISO 9002
QS 9000



276

FEATURES

L W H
1.25 x 0.759 x 1.14

- DUST COVERED
- DISPLACES APPROXIMATELY 1.1 CUBIC INCH
- VARIETY OF MOUNTING CONFIGURATIONS
- TV-5 RATINGS AVAILABLE

L W H
1.161 x 0.512 x 1.000

- EPOXY SEALED IMMERSION CLEANABLE
- MEETS 8 MILLIMETER SPACING COIL TO CONTACTS
- MEETS 4KV DIELECTRIC WITHSTANDING VOLTAGE

L W H
0.807 x 0.50 x 0.394

- SUBMINIATURE EPOXY SEALED IMMERSION CLEANABLE
- STANDARD 0.1 GRID PATTERN
- SINGLE SIDE STABLE DESIGN
- 5KV SURGE RESISTANCE COIL TO FRAME
- MEETS 4mm INTERNATIONAL SPACING COIL TO CONTACT

CONTACT DATA

CONTACT CONFIGURATION:

SPDT

SPDT & DPDT

SPST-NO. & SPDT

CONTACT MATERIAL:

SILVER CADMIUM OXIDE
SILVER, GOLD PLATED

SILVER CADMIUM OXIDE

SILVER ALLOY

MAX. CONTACT RATING:

3 AMP, 120 VAC, 28 VDC
(15 AMP, 150 VAC, 28 VDC)
5 AMP, 120 VAC, 28 VDC
10 AMP, 120/240 VAC, 28 VDC
(15 AMP, 150 VAC, 28 VDC)

SPDT:
20 AMP, 125 VAC, 30 VDC
10AMP, 48 VDC,
16 AMP, 250VAC, 30 VDC
DPDT:
5 AMP, 250 VAC, 30 VDC

SPST-NO:
10AMP, 250 VAC/30 VDC
SPDT:
7 AMP, 250 VAC/30 VDC

COIL DATA

STANDARD VOLTAGE

AC:
DC:

3, 5, 6, 12, 24 VDC

24, 120 & 240 VAC
5, 6, 12 & 24 VDC

5, 6, 12, & 24 VDC

NOMINAL COIL POWER
VA: (VAC)
WATTS: (VDC)
INSULATION SYSTEM PER
UL STANDARD 1446

400 MILLIWATTS

1.2 VA
0.54 WATTS

200 MILLIWATTS

GENERAL DATA

AMBIENT TEMPERATURE
OPERATING:

- 55°C TO +85°C

- 20°C TO +55°C

- 40°C TO +70°C

STORAGE:

- 55°C TO +130°C

- 40°C TO +80°C

DIELECTRIC STRENGTH:
(COIL TO FRAME)

1500 V rms

5000 V rms

2000 V rms

LIFE EXPECTANCY
ELECTRICAL:
MECHANICAL:

100,000 OPERATIONS
50,000,000 OPERATIONS

100,000 OPERATIONS
10,000,000 OPERATIONS

100,000 OPERATIONS
2,000,000 OPERATIONS

AGENCY APPROVALS



PAGE NUMBER

PAGE 17 - 18

PAGE 19 - 20

PAGE 21 - 22

DPDT 5 AMPS

UL US
UL Recognized
File No. E52197

OUTLINE DIMENSIONS
DIMENSIONS SHOWN IN INCHES & (MILLIMETERS).

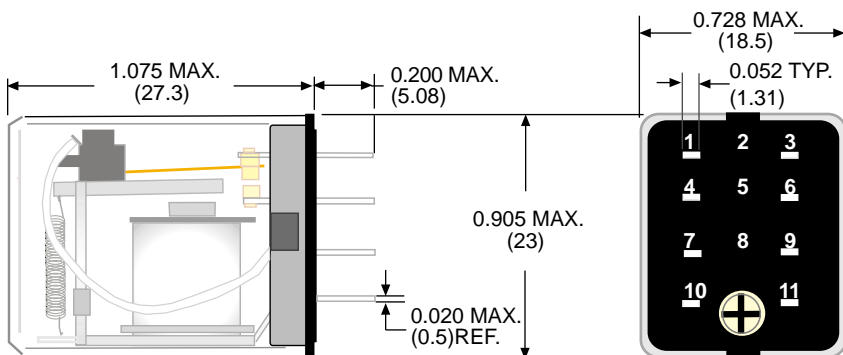

**MANUFACTURED UNDER
ISO 9002 & QS 9000**

**PRINTED CIRCUIT
MOUNTING HOLE LAYOUT
(BOTTOM VIEW)**

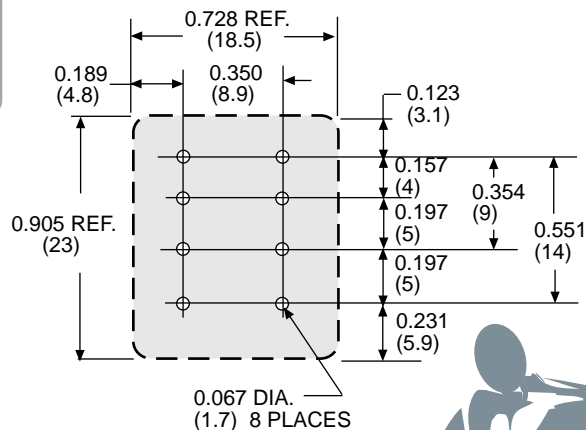

GENERAL SPECIFICATIONS

COIL

- Pull-in Voltage: 75% of nominal voltage or less for AC or DC coils
- Dropout Voltage: 10% min. or more for DC
- Max. Voltage: 110%
- Resistance: $\pm 10\%$ measured @ 25°C
- Duty: Continuous

CONTACTS

- Contact Material: Silver cadmium oxide, 0.093 Dia. (2.36)
- Contact Resistance: 100 milliohms max
- Contact Rating: UL RATED - 5 Amps @ 120 VAC resistive
NOT UL RATED - 30 VDC resistive,
3 Amp inductive, 1/8 Hp @ 120 VAC

TIMING

- Operate Time: 20 mS max
AC, 15 mS max. DC @ nominal voltage
- Release Time: 20 mS max.
AC, 15 mS max. DC @ nominal voltage

DIELECTRIC STRENGTH

- Coil to Frame: 1500 V rms
- Across Open Contacts: 500 V rms
- Contact to Frame: 1500 V rms
- Insulation Resistance: 1500 megohms min

TEMPERATURE

- Ambient Temperature: -45°C to +70°C @ rated operation

LIFE EXPECTANCY

- Electrical: 100,000 operations @ rated resistive load
- Mechanical: AC operated device in excess of
50,000,000 operations
DC operated devices, in excess of
100,000,000 operations

MISCELLANEOUS

- Operating Position: Any
- Insulating Material: Molded parts are diallyl phthalate for higher arc resistance
- Enclosure: Clear heat resistant polycarbonate dust cover
- Weight: 24 grams approx.



**CIRCUIT DIAGRAM
(VIEWED FROM PIN END)**

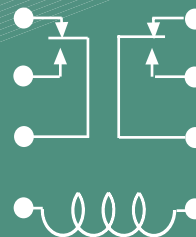

STANDARD PART NUMBERS	CONTACT CONFIGURATION	COIL MEASURED @ 25°C	
		NOMINAL INPUT VOLTAGE	NOMINAL RESISTANCE (OHMS)
AC OPERATED COILS			
W1330P-2C-24A	DPDT	24 VAC	245 Ω
W1330P-2C-120A	DPDT	120 VAC	5400 Ω
DC OPERATED COILS			
W1335P-2C-12D	DPDT	12 VDC	125 Ω
W1335P-2C-24D	DPDT	24 VDC	500 Ω

UL CONTACT LOAD RATINGS TABLE

LOAD	LOAD VOLTAGE	SPDT-N.O. LOAD	SPDT			
			N.O.	OPERATIONS	N.C.	OPERATIONS
RESISTIVE	240 VAC	30 AMP	20 AMP	100,000	2-10 AMP	100,000
RESISTIVE	277 VAC	20 AMP	20 AMP	100,000	15AMP @ 250VAC	100,000
RESISTIVE	5-30 VDC	20 AMP	20 AMP	100,000	10 AMP	100,000
INDUCTIVE RESISTIVE	277 VAC	12 AMP	12 AMP	6,000	6 AMP	6,000
MOTOR	125 VAC	1 HP	1 HP	30,000	1/4 HP	-
	125 VAC	3/4 HP	3/4 HP	100,000	-	-
	240/250VAC	2 HP	2 HP	1,000	1/2 HP	-
	125/240 VDC	470 VA	470 VA	100,000	275 VA	30,000
FLA/LRA‡	125 VAC	30/96	30/96	30,000	10/33	30,000
	240 VAC	30/80	30/80	30,000	10/33	30,000
	277 VAC	20/60	20/60	100,000	-	-
	125 VAC	27/82	27/82	100,000	-	-
TUNGSTEN	250 VAC	TV - 3	TV - 3	25,000	TV - 3	-
BALLAST	277 VAC	6 AMP	6 AMP	6,000	3 AMP	6,000

‡ FLA = Full load Amps, LRA = Locked rotor Amps.

SPST-N.O. & SPDT 30 AMPS



COMPLIES WITH REQUIREMENTS OF

* IEC STANDARDS 947-4-1 AND 947-5-1 LOW VOLTAGE DIRECTIVE

* IEC = INTERNATIONAL ELECTROTECHNICAL COMMISSION

* CE TESTING AND EVALUATION PERFORMED BY THE UNDERWRITERS LABORATORIES AS A THIRD PARTY PARTICIPANT

MANUFACTURED UNDER ISO 9002 & QS 9000

CLASS "B" OR "F" INSULATION EPOXY SEALED. BREAKAWAY NIB OVER VENT HOLE (REMOVED AFTER CLEANING).

CLASS 90 PRINTED CIRCUIT BOARD RELAYS PROVIDE AN INEXPENSIVE MEANS OF SWITCHING LOADS UP TO 30 AMPS. DESIGNED PRIMARILY FOR THE APPLIANCE INDUSTRY AND HVAC MARKETS, THEY ARE ALSO WELL SUITED FOR LOAD MANAGEMENT, AUTOMOTIVE AND OTHER APPLICATIONS.

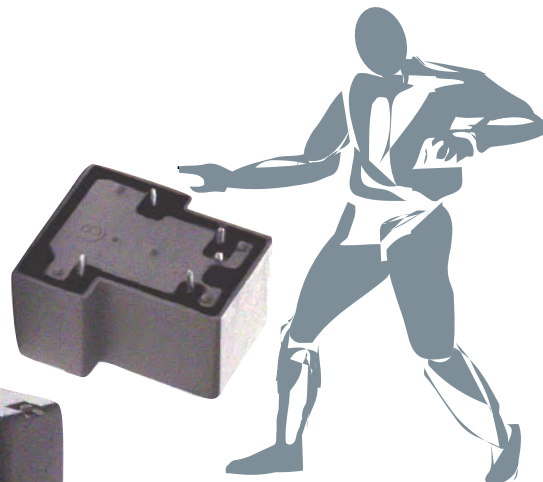

GENERAL SPECIFICATIONS

COIL

Pull-in Voltage: 75% of nominal voltage or less
 Dropout Voltage: 10% of nominal voltage or more
 Resistance: ±10% measured @ 25°C
 Coil Power: 2.8 watts max
 Insulation System: Class "B" (130°C) or class "F" (155°C)
 Duty: Continuous

CONTACTS

Contact Material: Silver cadmium oxide
 Contact Resistance: 50 milliohms max. initial value

TIMING

Operate Time: 15 mS max. @ nominal voltage
 Release Time: 10mS max. @ nominal voltage

DIELECTRIC STRENGTH

Contacts to Coil: 1500 V rms
 Across Open Contacts: 1000 V rms
 Insulation Resistance: 500 megohms under normal conditions 100 megohms high temp, high humidity

TEMPERATURE

Operating: -55°C to +105°C
 Storage: -55°C to +130°C
 Relative Humidity: Up to 93% @ 40°C
 Atmospheric Pressure: 650 to 800 mmHg

VIBRATION RESISTANCE

Functional: 10 to 55 Hz @ double amplitude of 1 mm

SHOCK RESISTANCE

Functional: 10 g's for 11 mS, no contact opening > 100uS
 Mechanical: 100 g's

LIFE EXPECTANCY

Electrical: 100,000 operations @ rated resistive load
 Mechanical: 10,000,000 operations @ no load

MISCELLANEOUS

Operating position: Any
 Enclosure: 94V-0 flammability rating, epoxy sealed immersion cleanable
 Weight: 27 grams approx

OUTLINE DIMENSIONS

DIMENSIONS SHOWN IN INCHES & (MILLIMETERS).

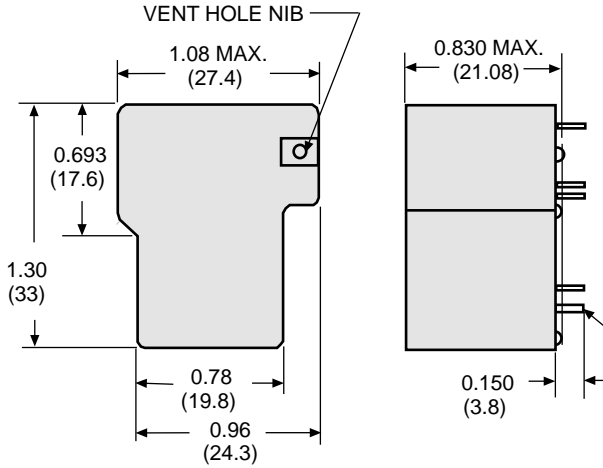

PIN REMOVED ON CLASS "F" STYLES

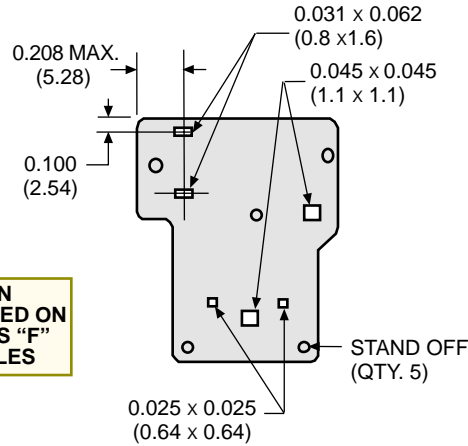

PRINTED CIRCUIT MOUNTING HOLE LAYOUT (BOTTOM VIEW)

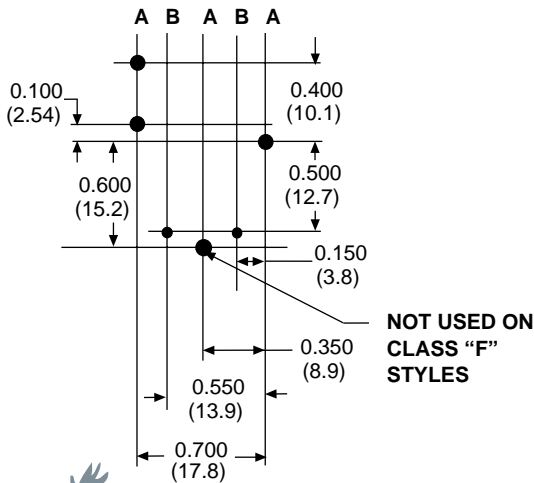

DRILL "A" HOLES 0.086
DRILL "B" HOLES 0.046

WIRING DIAGRAM (VIEWED FROM PIN END)

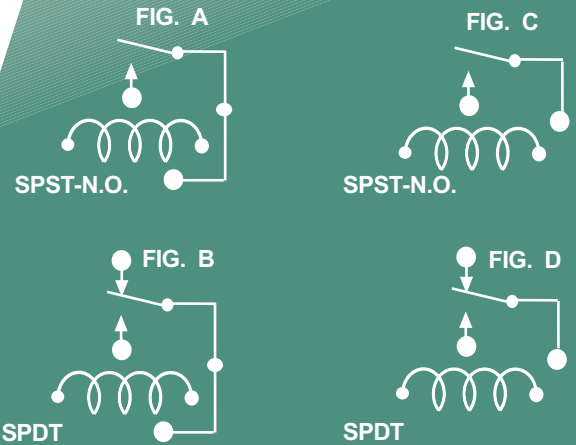

STANDARD PART NUMBERS	CONTACT CONFIGURATION	COIL MEASURED @ 25°C	
		NOMINAL INPUT VOLTAGE	NOMINAL RESISTANCE (OHMS)
CLASS "B" INSULATION, FIG. "A", 30 AMP			
W90S1D12-5	SPST-NO	5 VDC	27 Ω
W90S1D12-12	SPST-NO	12 VDC	155 Ω
W90S1D12-24	SPST-NO	24 VDC	660 Ω
W90S1D12-110	SPST-NO	110 VDC	13,450 Ω
CLASS "B" INSULATION, FIG. "B", 20 AMP			
W90S5D12-5	SPDT	5 VDC	27 Ω
W90S5D12-12	SPDT	12 VDC	155 Ω
W90S5D12-24	SPDT	24 VDC	660 Ω
W90S5D12-110	SPDT	110 VDC	13,450 Ω
CLASS "F" INSULATION, FIG. "C", 30 AMP			
W90S1D42-5	SPST-NO	5 VDC	27 Ω
W90S1D42-12	SPST-NO	12 VDC	155 Ω
W90S1D42-24	SPST-NO	24 VDC	660 Ω
W90S1D42-110	SPST-NO	110 VDC	13,450 Ω
CLASS "F" INSULATION, FIG. "D", 20 AMP			
W90S5D42-5	SPDT	5 VDC	27 Ω
W90S5D42-12	SPDT	12 VDC	155 Ω
W90S5D42-24	SPDT	24 VDC	660 Ω
W90S5D42-110	SPDT	110 VDC	13,450 Ω

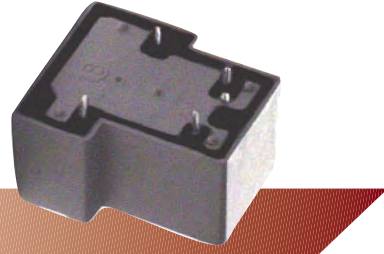

UL CONTACT LOAD RATINGS TABLE

LOAD	LOAD VOLTAGE	SPST	SPDT		OPERATIONS
		N.O. LOAD	N.O.LOAD	N.C.LOAD	
GENERAL PURPOSE	240 VAC	30AMP	30AMP	15AMP	100,000
RESISTIVE	28 VDC	30AMP	30AMP	10AMP	100,000
MOTOR	125 VAC	1 HP	1 HP	1/4 HP	1,000
	240 VAC	2 HP	2 HP	1/2 HP	6,000
FLA/LRA ‡	120 VAC	22/98AMP	22/98AMP	-	100,000
	240 VAC	30/80AMP	30/80AMP	12/30AMP	30,000
TUNGSTEN	240 VAC	TV - 5	TV - 5	-	25,000
BALLAST	277 VAC	10AMP	10AMP	3AMP	6,000
PILOT DUTY	240 VAC	470 VAC	470 VAC	275 VAC	6,000

‡ FLA = Full load amps, LRA = Locked rotor amps.

SPST-N.O. & SPDT 30 AMPS



**CLASS "F" INSULATION.
EPOXY SEALED WITH REMOVABLE
TAPE SEAL OVER VENT HOLE
(REMOVED AFTER CLEANING)**

MEETS UL 508, UL 873 AND
UL 1950 - 1/8" THRU AIR - 1/4"
OVER SURFACE (SEE NOTES)

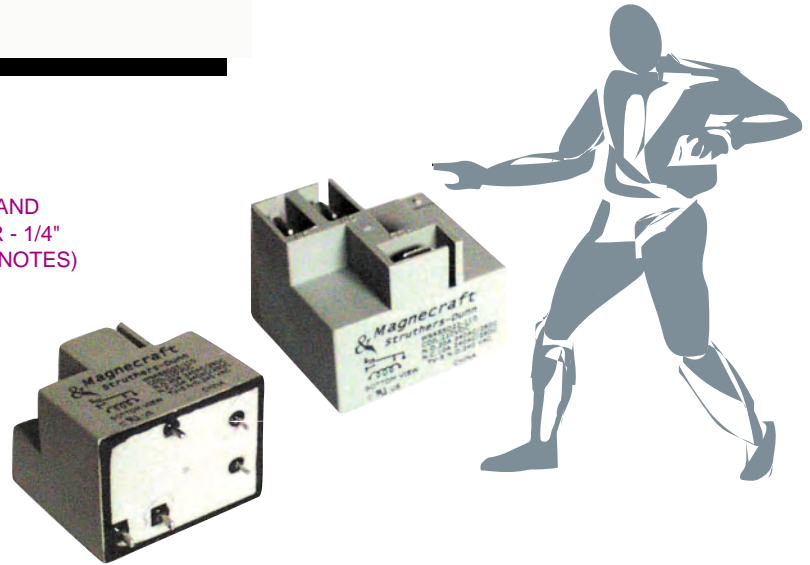

GENERAL SPECIFICATIONS

COIL

Pull-in Voltage: 80% of nominal voltage or less for AC coils
75% of nominal voltage or less for DC coils
Dropout Voltage: 10% of nominal voltage or more
Max. Coil Voltage: 120% max.
Power Consumption: AC coil: 0.95 VA, DC coil: 2.8 watts max.
Insulation System: Class "F"(155°C)
Resistance: ±10% measured @ 25°C
Duty: Continuous

TEMPERATURE

Operating: -55°C to +85°C
Storage: -55°C to +130°C

VIBRATION RESISTANCE

Functional: 10 to 55Hz 1.65 mm max.
No contact opening > 100 uS

SHOCK RESISTANCE

Functional: 10 g's for 11 mS,
no contact opening > 100 μS
Mechanical: 100 g's

CONTACT

Contact Material: Silver cadmium oxide
Switching Voltage: 277 VAC, 28 VDC max.
Contact Resistance: 75 milliohms @ 1 Amp rated current
Minimum Load: 1 A, 5 VDC, 12 VAC

LIFE EXPECTANCY

Electrical: 100,000 operations
@ rated resistive load
Mechanical: 10,000,000 operations @ no load

TIMING

Operate Time: DC:15 mS typ. Including bounce
Release Time: DC:15mS typ. Including bounce

MISCELLANEOUS

Operating Position: Any
Enclosure: Epoxy sealed immersion cleanable suitable for automatic circuit board processing. Max. Exposure soldering temperature is 4 sec. @ 500°F.
Enclosure: 94V-O flammability rating
Terminals: 1/4" quick connect & safety wells accept insulated female quick connect terminals
Weight: 33 grams approx

DIELECTRIC STRENGTH

Contacts to Coil: 2500 V rms
Between Open Contacts: 1500 V rms
Insulation Resistance: 1000 mΩ min. @ 500 VDC,
25°C 50% Rh

OUTLINE DIMENSIONS
DIMENSIONS SHOWN IN INCHES & (MILLIMETERS).

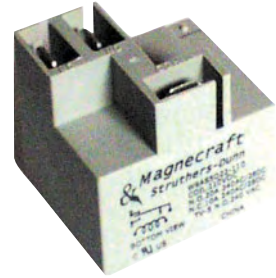
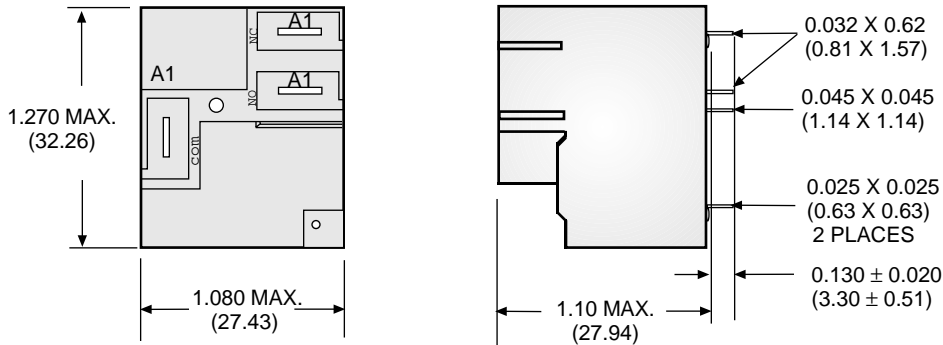

PRINTED CIRCUIT MOUNTING HOLE LAYOUT
(BOTTOM VIEW)

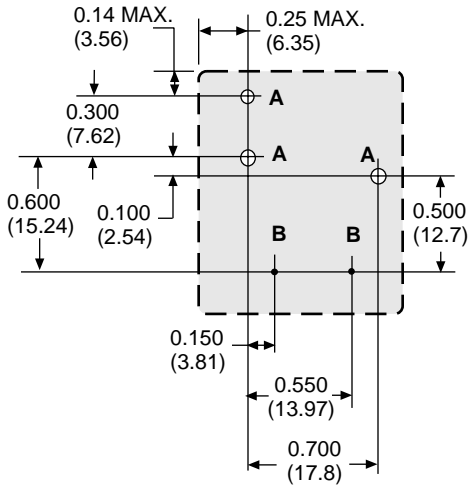

HOLE "A" = 0.081 ± 0.005 DIA.
(2.06 X 0.13)
HOLE "B" = 0.043 ± 0.08 DIA.
(1.09 X 0.08)

WIRING DIAGRAM
(VIEWED FROM PIN END)

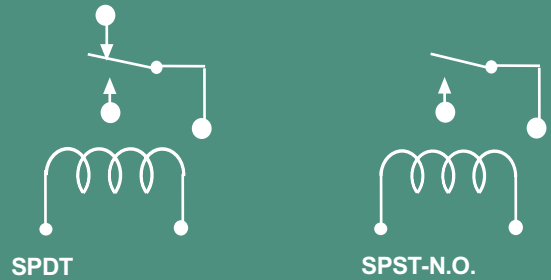

STANDARD PART NUMBERS	CONTACT CONFIGURATION	COIL MEASURED @ 25°C	
		NOMINAL INPUT VOLTAGE	NOMINAL RESISTANCE (OHMS)
PRINTED CIRCUIT MOUNT, 30 AMP			
W9AS1D22-5	SPST-NO	5 VDC	25 Ω
W9AS1D22-12	SPST-NO	12 VDC	144 Ω
W9AS1D22-24	SPST-NO	24 VDC	576 Ω
W9AS1D22-110	SPST-NO	110 VDC	12100 Ω
PRINTED CIRCUIT MOUNT, 20 AMP			
W9AS5D22-5	SPDT	5 VDC	25 Ω
W9AS5D22-12	SPDT	12 VDC	144 Ω
W9AS5D22-24	SPDT	24 VDC	576 Ω
W9AS5D22-110	SPDT	110 VDC	12100 Ω
PRINTED CIRCUIT MOUNT, 30 AMP			
W9AS1A22-24	SPST-NO	24 VAC	
W9AS1A22-120	SPST-NO	120 VAC	
W9AS1A22-240	SPST-NO	240 VAC	
PRINTED CIRCUIT MOUNT, 20 AMP			
W9AS5A22-24	SPDT	24 VAC	
W9AS5A22-120	SPDT	120 VAC	
W9AS5A22-240	SPDT	240 VAC	

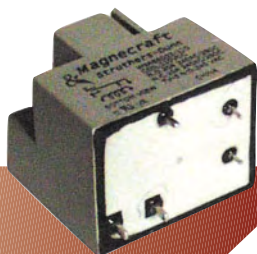
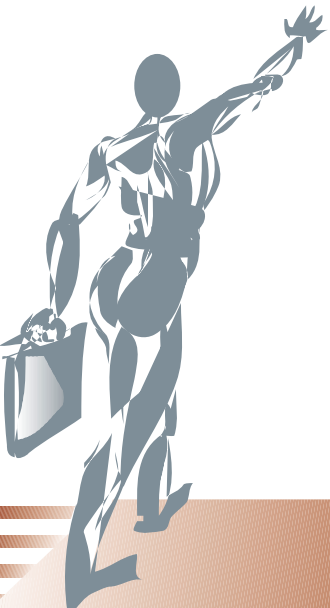

DPST-N.O. & DPDT 30 AMPS

UL CONTACT LOAD RATINGS TABLE

RATING	LOAD VOLTAGE	DPST-N.O. & DPDT	DPDT	OPERATIONS
		N.O. LOAD	N.C. LOAD	
RESISTIVE LOAD	120/277 VAC	30 AMP	3 A MP	6,000
	28 VDC	20 AMP	3 A MP	100,000
MOTOR	120 VAC	1 HP	-	1000
	240 VAC	3 HP	-	1000
TUNGSTEN	120 VAC	TV-10	-	25,000
LRA/FLA*	240 VAC	96/22	-	30,000
		110/25.3	-	
PILOT DUTY	240 VAC	3 AMP	-	6,000

UL us
UL Recognized
File No. E43641

Note: Vent tape must be removed to achieve listed ratings

* FLA = Full load Amps, LRA = Locked rotor Amps.

CLASS "F" INSULATION. EPOXY SEALED WITH REMOVABLE TAPE SEAL OVER VENT HOLE (REMOVED AFTER CLEANING).

MEETS UL 873 AND
UL 508 SPACING - (8MM)
THRU AIR, (9.5 MM)
OVER SURFACE

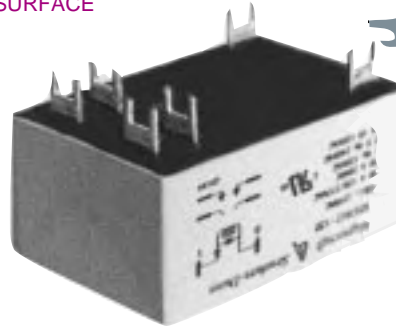

GENERAL SPECIFICATIONS

COIL

Pull-in Voltage: AC: 80% of nominal voltage or less
DC: 75% of nominal voltage or less

Dropout Voltage: 10% of nominal voltage or more

Max. Operating Frequency: 14 operations per minute

Coil Power: AC coil: 4.0VA, DC coil: 1.7W

Insulation System: Class "F" (155°C)

Coil Resistance: ±10% measured @ 25°C

Duty: Continuous

CONTACT

Contact Material: Silver cadmium oxide

Contact Load Ratings: See: "UL CONTACT LOAD RATINGS TABLE"

Contact Resistance: 100,000,000 @ initial rated current (switched)

Minimum Load: N.O. 500 mA @ 12 VAC/VDC
N.C. 100 mA @ 6 VAC/VDC

TIMING

Operate Time: DC: 15 mS typ. 25ms W / Bounce

Release Time: DC: 10mS typ. 25 ms W / Bounce

DIELECTRIC STRENGTH

Between Open Contacts: 1500 V rms

Contacts to Coil: 4000V rms

Insulation Resistance: 10³ meg Ω min. @ 500 VDC, 50% Rh

TEMPERATURE

Operating: AC coil rectified: -40°C to +85°C,
DC: -40°C to +85°C

Storage: -55°C to +155°C

VIBRATION RESISTANCE

Functional: 0.065 (1.65 mm) double amplitude
-10 thru 55 Hz

SHOCK RESISTANCE

Functional: 10 g's for 11 mS,
1/2 sign wave pulse with no
contact opening > 100µs

Mechanical: 100 g for 11 ms 1/2 sine wave pulse

LIFE EXPECTANCY

Electrical: 100,000 operations
@ rated resistive load

Mechanical: 5,000,000 operations @ no load

MISCELLANEOUS

Operating Position: Any

Enclosure: Epoxy sealed immersion cleanable
tape sealed plastic cover

Flammability: 94V-O Flammability rating

Weight: 86 g approx

OUTLINE DIMENSIONS
DIMENSIONS SHOWN IN INCHES & (MILLIMETERS).

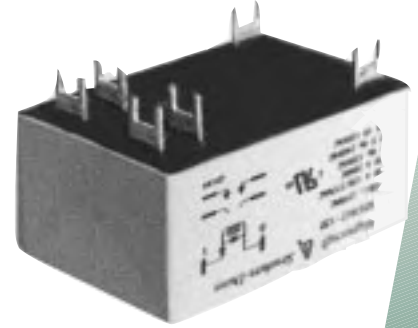
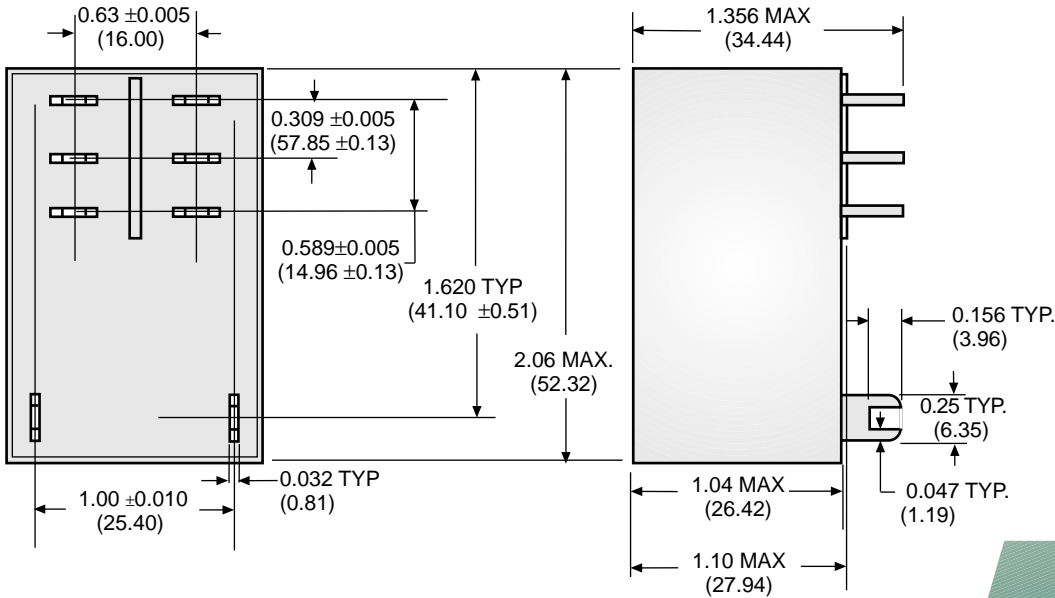

PRINTED CIRCUIT MOUNTING HOLE LAYOUT
(BOTTOM VIEW)

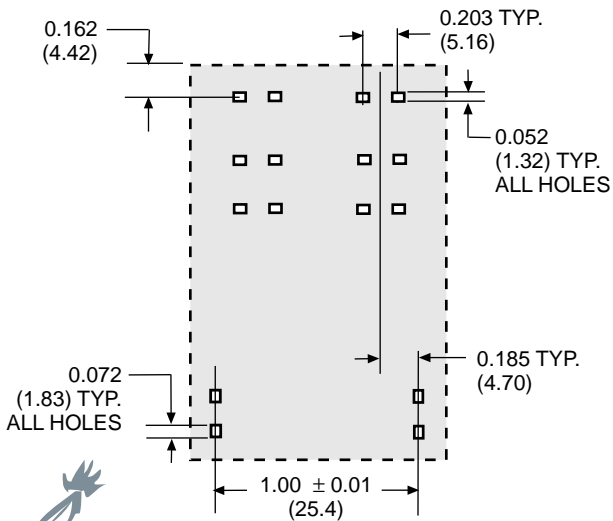

NOTE:
VENT TAPE MUST BE REMOVED
TO ACHIEVE LISTED RATINGS

WIRING DIAGRAM
(VIEWED FROM PIN END)

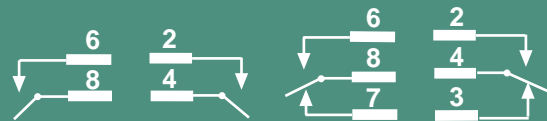

DPST-N.O.



DPDT

STANDARD PART NUMBERS	CONTACT CONFIGURATION	COIL MEASURED @ 25°C	
		NOMINAL INPUT VOLTAGE	NOMINAL RESISTANCE (OHMS)
AC OPERATED COIL PRINTED CIRCUIT MOUNT, 30 AMP			
W92S7A12-24	DPST-NO	24 VAC	-
W92S7A12-120	DPST-NO	120 VAC	-
W92S7A12-240	DPST-NO	240 VAC	-
W92S11A12-24	DPDT	24 VAC	-
W92S11A12-120	DPDT	120 VAC	-
W92S11A12-240	DPDT	240 VAC	-
DC OPERATED COIL PRINTED CIRCUIT MOUNT, 30 AMP			
W92S7D12-12	DPST-NO	12 VDC	86 Ω
W92S7D12-24	DPST-NO	24 VDC	350 Ω
W92S7D12-48	DPST-NO	48 VDC	1,390 Ω
W92S7D12-110	DPST-NO	110 VDC	7,255 Ω
W92S11D12-12	DPDT	12 VDC	86 Ω
W92S11D12-24	DPDT	24 VDC	350 Ω
W92S11D12-48	DPDT	48 VDC	1,390 Ω
W92S11D12-110	DPDT	110 VDC	7,255 Ω



R.F. PERFORMANCE TABLE

SPDT & DPDT 2AMP

FREQUENCY (MHZ)	INSERTION LOSS (DB) COMMON TO N.O. OR N.C. CONTACTS	VSWR COMMON TO N.O. OR N.C. CONTACTS	ISOLATION (DB) N.O. OR N.C. CONTACTS TO COIL
10	0.05	1.03:1	65
50	0.10	1.04:1	50
100	0.30	1.05:1	42
200	0.50	1.06:1	35
300	0.60	1.07:1	31
400	0.65	1.08:1	29
500	0.75	1.10:1	28



UL Recognized
File No. E52197

* AVAILABLE WITH SPDT OR DPDT BIFURCATED GOLD CLAD SILVER-PALLADIUM CROSS BAR CONTACTS- RATED FOR LOW LEVEL TO 2.0 AMP SWITCHING.

* REQUIRES ONLY .155 SQUARE INCH OF CIRCUIT BOARD SPACE.

* TOTAL VOLUME OF LESS THAN A CUBIC CENTIMETER.

* CONFORMS TO FCC PART 68.302. 1500 V PEAK SURGE RESISTANCE.

* CONFORMS TO FCC PART 68.304. 1000 V DIELECTRIC WITHSTANDING VOLTAGE.

THE CLASS 7 SUBMINIATURE HIGH RELIABILITY INDUSTRIAL GRADE RELAY HAS EXCELLENT R.F. SWITCHING CHARACTERISTICS.

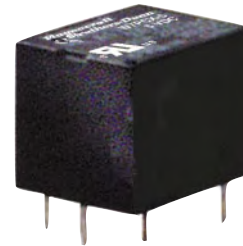

GENERAL SPECIFICATIONS

COIL	
Pull-in Voltage:	80% of nominal voltage or less
Dropout Voltage:	10 % of nominal voltage or more
Max. Voltage:	120% of nominal voltage, duty cycle: 100%.
Resistance:	±10%
Coil Power:	327 milliwatts max., min sensitivity: 200 milliwatts.
Max. Coil Dissipation	0.75 watts.
CONTACTS	
Contact Material:	Gold clad silver palladium.
Contact Rating:	SPDT: 50 uA @ 50mV, 2A , 24 VDC, 2A, 120 VAC, DPDT: 50 uA @ 50mV, 2A, 24 VDC, 0.6A, 100 VAC, initial 50 mΩ
Contact Resistance:	100 milliohms max @ 6 VDC 10 milliamps.
TIMING	
Operate Time:	4.0 mS max. @ nominal voltage typ.
Release Time:	5.0 mS max. @ nominal voltage typ.
DIELECTRIC STRENGTH	
All Mutually Insulated Points:	500 VAC for 1 minute, 1 milliamp max. leakage, or 600 VAC for 1 second, 1 milliamp leakage.
Surge Test:	Meets FCC 68.302 (1500V surge) and 68.304 (1000V dielectric).
Insulation Resistance:	500 VDC exceeds 1000 megohms.

TEMPERATURE	
Operating:	-35°C to +70°C
VIBRATION RESISTANCE	
Functional:	15 g's, 10 to 2000 Hz, no contact opening > 10 uS max. contact chatter destructive: 50 g's.
SHOCK RESISTANCE	
Functional	50g's 6mS half sine
Mechanical:	Destructive: 150 g's.
LIFE EXPECTANCY	
Electrical:	100,000 operations- 2 Amp 24 VDC, 1.0 Amps 120VAC @ rated resistive load.
Mechanical:	100,000,000 operations @ no load
MISCELLANEOUS	
Terminal Finish:	Terminals are solder coated and epoxy free to provide excellent solderability. Max. Exposure to soldering temperature is 5 seconds @ 250°C. after cleaning process, pierce a small hole in cover for venting.
Operating Position:	Any
Enclosure:	UL, 94V-O plastic, epoxy sealed.
Weight:	2.7 g Approx.

OUTLINE DIMENSIONS

DIMENSIONS SHOWN IN INCHES & (MILLIMETERS).

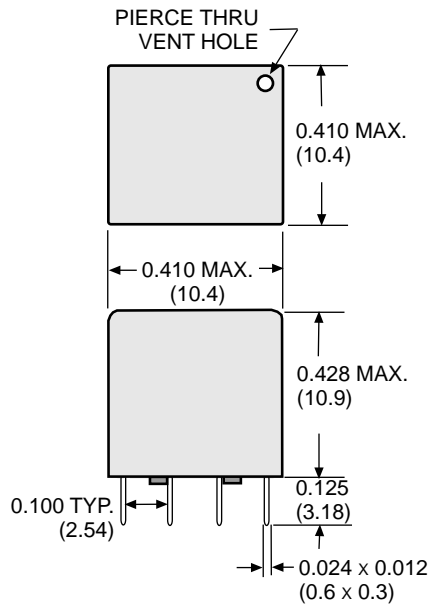

PRINTED CIRCUIT MOUNTING HOLE LAYOUT (BOTTOM VIEW)

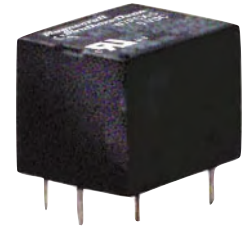
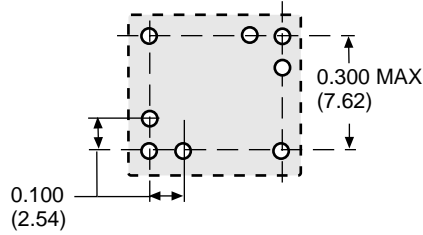

After cleaning process, pierce 0.40 (1mm) hole in cover for venting.

TOP VIEW SHOWN AT ACTUAL SIZE ON 0.1 GRID

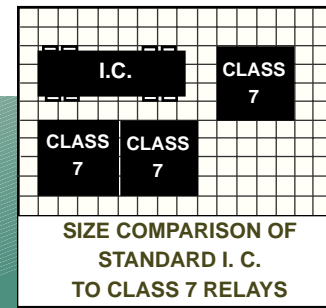

SIZE COMPARISON OF STANDARD I. C. TO CLASS 7 RELAYS

THE CLASS 7 RELAYS CAN BE DENSELY PACKED TOGETHER WITHOUT MAGNETIC INTERACTION FROM ADJACENT RELAYS.

COIL TEMPERATURE RISE

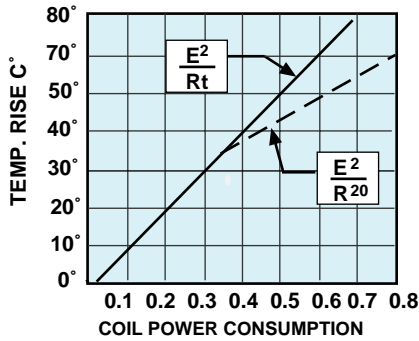

OPERATE / RELEASE TIME

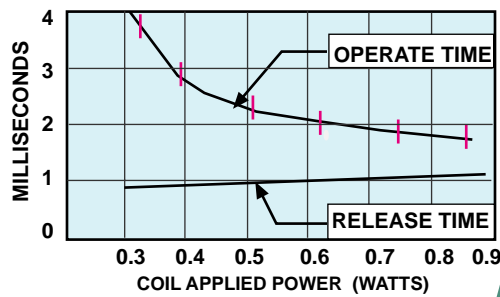

$$\frac{E^2}{R_t} = \frac{\text{COIL VOLTAGE}}{\text{COIL RESISTANCE VALUE AFTER TEMP. WAS RAISED}}$$

$$\frac{E^2}{R^{20}} = \frac{\text{COIL VOLTAGE}}{\text{AT } 20^\circ\text{C COIL RESISTANCE VALUE}}$$

WIRING DIAGRAM

(VIEWED FROM PIN END)

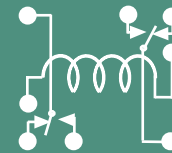

DPDT

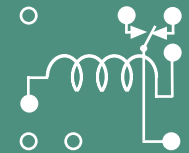

SPDT

COIL MEASURED @ 25°C

STANDARD PART NUMBERS	CONTACT CONFIGURATION	NOMINAL INPUT VOLTAGE	NOMINAL RESISTANCE (OHMS)
W7PCX-1	SPDT	5 VDC	75 Ω
W7PCX-3	SPDT	12 VDC	440 Ω
W7PCX-4	SPDT	24 VDC	1550 Ω
W7PCX-5	DPDT	5 VDC	75 Ω
W7PCX-7	DPDT	12 VDC	440 Ω
W7PCX-8	DPDT	24 VDC	1550 Ω



SPDT & DPDT 2 AMP

R.F. PERFORMANCE TABLE

FREQUENCY (MHZ)	INSERTION LOSS (DB) COMMON TO N.O. OR N.C. CONTACTS	VSWR COMMON TO N.O. OR N.C. CONTACTS	ISOLATION (DB) N.O. OR N.C. CONTACTS TO COIL
10	0.05	1.03:1	65
50	0.10	1.04:1	50
100	0.30	1.05:1	42
200	0.50	1.06:1	35
300	0.60	1.07:1	31
400	0.65	1.08:1	29
500	0.75	1.10:1	28

cULus
UL Recognized
File No. E52197

*** AVAILABLE WITH SPDT OR DPDT BIFURCATED GOLD CLAD SILVER-PALLADIUM CROSS BAR CONTACTS- RATED FOR LOW LEVEL TO 2.0 AMP SWITCHING.**

*** REQUIRES ONLY 0.155 SQUARE INCH OF CIRCUIT BOARD SPACE.**

*** TOTAL VOLUME OF LESS THAN A CUBIC CENTIMETER.**

*** CONFORMS TO FCC PART 68.302. 1500 V PEAK SURGE RESISTANCE.**

*** CONFORMS TO FCC PART 68.304. 1000 V DIELECTRIC WITHSTANDING VOLTAGE.**

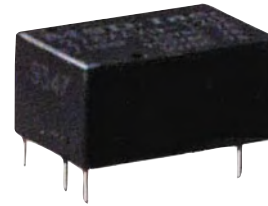

GENERAL SPECIFICATIONS

COIL
 Pull-in Voltage: 80% of nominal voltage or less
 Dropout Voltage: 10% of nominal voltage or more
 Max. Voltage: 120% of nominal voltage, duty cycle 100%
 Resistance: ±10% measured @ 25°C 327mW max.
 Coil Power: Min. sensitivity: 200 mW
 Max. Coil Dissipation: 0.75 watt

CONTACTS
 Contact Material: Gold clad silver palladium.
 Contact Rating: Low level: 50uA- 50mV, SPDT: 2 A-24 VDC, 2A-120 VAC, DPDT: 2 A-24 VDC, 0.6A-100 VAC,
 Contact Resistance: Initial 50 milliohms @ 6 VDC, 10mA, 100 milliohms max.

TIMING
 Operate Time: 4.0 mS max. @ nominal voltage.
 Release Time: 10.0 mS max. @ nominal voltage.
 Contact Bounce: 2.5 mS operate, 5.0 mS release

DIELECTRIC STRENGTH
 All Mutually Insulated Points: 500 VAC for 1 minute, 1 milliamp max. leakage, or 600 VAC for 1 second, 1 milliamp leakage.
 Surge Test: Meets FCC 68.302 (1500V surge) and 68.304 (1000V dielectric).
 Insulation Resistance: 500 VDC exceeds 1000 megohms.

TEMPERATURE
 Operating: -35°C to +70°C

VIBRATION RESISTANCE
 Functional: 15g's, 10 to 2000 Hz, no contact opening greater than 10µS

SHOCK RESISTANCE
 Functional: 50g's, 6mS max.
 Mechanical: Contact chatter destructive 50g's.

LIFE EXPECTANCY
 Electrical: 100,000 operations @ rated resistive load.
 Mechanical: 100,000,000 operations @ no load

MISCELLANEOUS
 Terminal Finish: Terminals are solder coated to provide excellent solderability. max. exposure to soldering temperature is 5 seconds @ 250°C.
 Operating Position: Any
 Enclosure: Plastic.
 Weight: SPDT-5.5 g, DPDT- 9 g Approx.

OUTLINE DIMENSIONS

DIMENSIONS SHOWN IN INCHES & (MILLIMETERS).

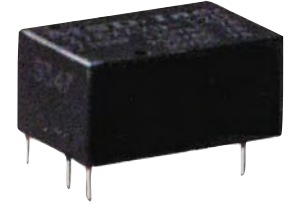
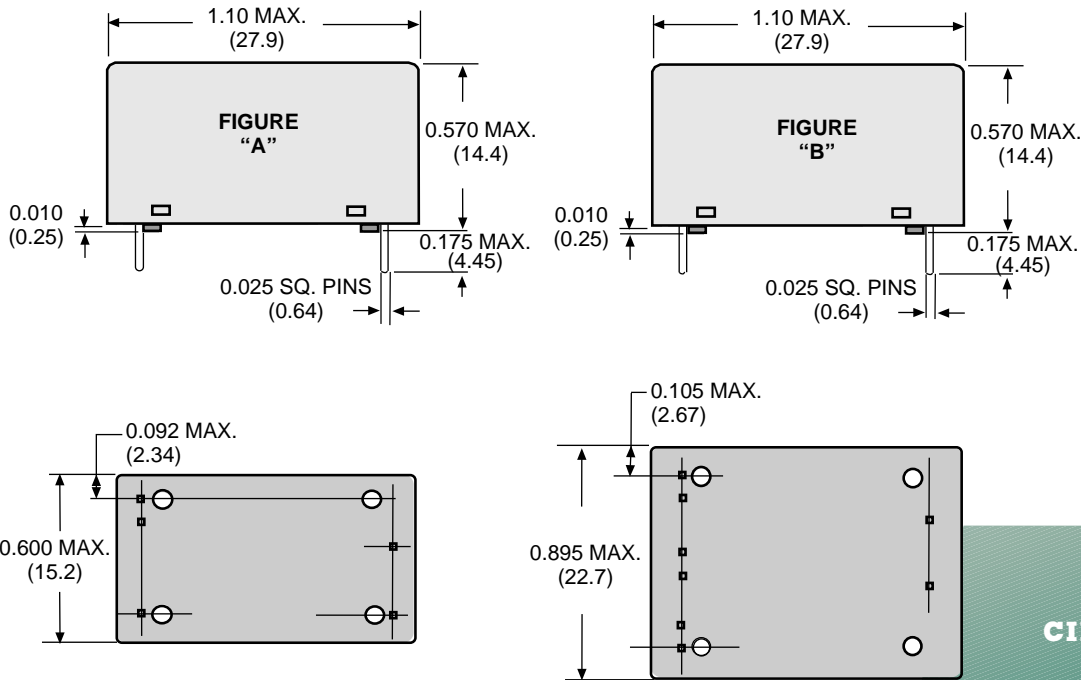

PRINTED CIRCUIT MOUNTING HOLE LAYOUT

(TOP VIEW SHOWN AT ACTUAL SIZE ON 0.1 GRID)

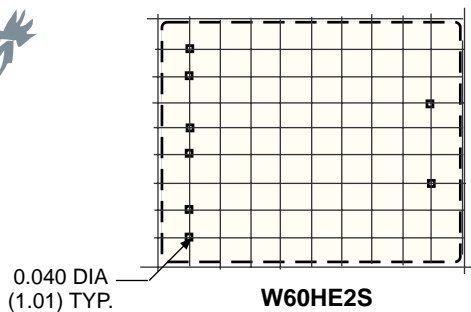
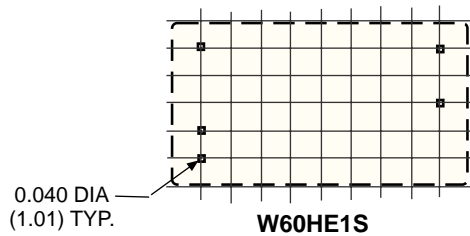

CIRCUIT DIAGRAMS (BOTTOM VIEW)

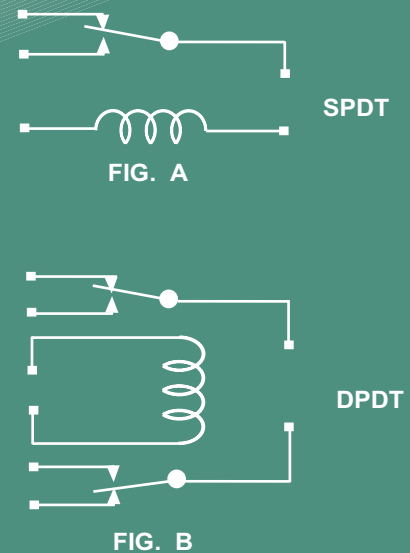

STANDARD PART NUMBERS	CONTACT CONFIGURATION	COIL MEASURED @ 25°C	
		NOMINAL INPUT VOLTAGE	NOMINAL RESISTANCE (OHMS)
FIG. A			
W60HE1S-5DC	SPDT	5 VDC	75
W60HE1S-12DC	SPDT	12 VDC	440
W60HE1S-24DC	SPDT	24 VDC	1550
W60HE1S-48DC	SPDT	48 VDC	5250
FIG. B			
W60HE2S-5DC	DPDT	5 VDC	75
W60HE2S-12DC	DPDT	12 VDC	440
W60HE2S-24DC	DPDT	24 VDC	1550
W60HE2S-48DC	DPDT	48 VDC	5250 Ω



UL CONTACT LOAD RATINGS TABLE

LOAD	LOAD VOLTAGE	SPDT		SPST-	
		N.O. & N.C. LOAD	N.O. LOAD	N.C. LOAD	OPERATIONS
GENERAL	277 VAC	10AMP	-	-	100,000
RESISTIVE	120 VAC	-	-	12 AMP	100,000
RESISTIVE	120 VAC	-	12 AMP	-	20,000
GENERAL	125 VAC	-	15 AMP	-	6,000
RESISTIVE	30 VDC	12 AMP	-	-	100,000
MOTOR	120 VAC	-	1/4 HP	-	34,000
	120 VAC	-	-	1/4 HP	21,000
BALLAST	120 VAC	-	15 AMP	-	7,000
	480 VAC	3.75 AMP	-	-	100,000
TUNGSTEN	120 VAC	-	TV - 5	-	6,000

**SPST- N.O. 15 AMPS
& SPDT 10 AMPS**

UL
us
UL Recognized
File No. E195668

**CLASS "B" & "F" COIL INSULATION SYSTEM.
WITHSTANDS THE VAPOR AND SPRAY
CLEANING OF MOST FLUXING SYSTEMS.
TERMINALS ARE SOLDER COATED TO
PROVIDE EXCELLENT SOLDERABILITY.**

PART NUMBERS SHOWN AVAILABLE FROM
YOUR LOCAL MAGNECRAFT & STRUTHERS-DUNN
DISTRIBUTION. UL CLASS "F" COIL INSULATION
SYSTEM AVAILABLE ON SPECIAL ORDER.

CONTACT FACTORY.

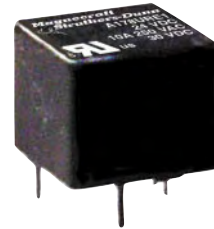

GENERAL SPECIFICATIONS

COIL

Pull-in Voltage: 75% of nominal voltage or less
Dropout Voltage: 10% min. of nominal voltage or more
Max. Voltage: 110%
Resistance: ±10% measured @ 20°C
Coil Power: 0.36 watts, 48 VDC : 0.51watts
Insulation System: Class "B"
(130°C per UL standart 1446)
Duty: Continuous

CONTACTS

Contact Material: Silver alloy
Contact Rating: See "UL CONTACT LOAD RATING TABLE"
Contact Resistance: 100 milliohms @ 24 VDC & 1 Amp max
Max. Switching Power: 2400 VA / 240 W
Min. Load: 6 VDC / 0.1 A

TIMING

Operate Time: 10 mS max. @ nominal voltage
Release Time: 5 mS max. @ nominal voltage

DIELECTRIC STRENGTH

Contacts to Coil: 1500 V rms
Across Open Contacts: 750 V rms
Insulation Resistance: 100 Megohms @ 500 VDC

TEMPERATURE

Operating: -40°C to +70°C
Storage: -40°C to +80°C

VIBRATION RESISTANCE

Functional: 10 to 55Hz dual amplitude 1.5 mm

SHOCK RESISTANCE

Functional: 10 g' s
Mechanical: 100 g' s

LIFE EXPECTANCY

Electrical: 100,000 operations
@ rated resistive load.
Mechanical: 10,000,000 operations @ no load

MISCELLANEOUS

Operating Position: Any
Enclosure: Plastic, epoxy sealed, suitable for automatic circuit board processing. After cleaning process, pierce a small hole in cover for venting
Weight: 10 g Approx.

**SPST- N.O. 15 AMPS
& SPDT 10 AMPS**

OUTLINE DIMENSIONS
DIMENSIONS SHOWN IN INCHES & (MILLIMETERS).

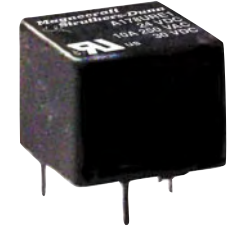
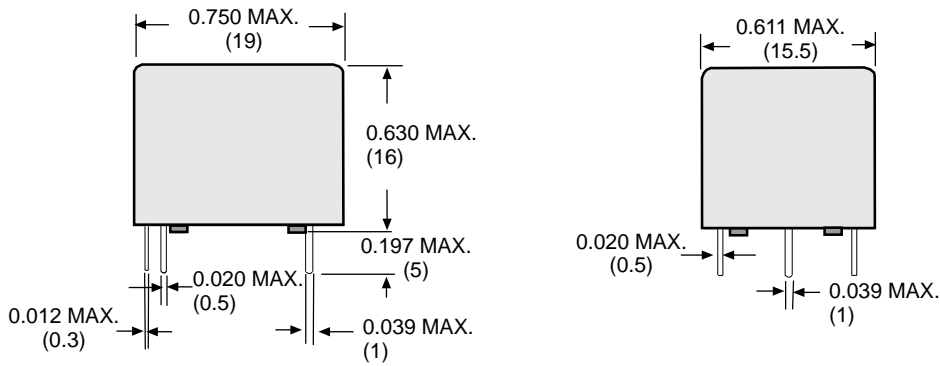

PRINTED CIRCUIT MOUNTING HOLE LAYOUT (BOTTOM VIEW)

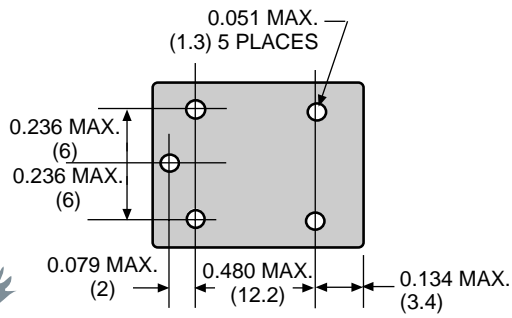
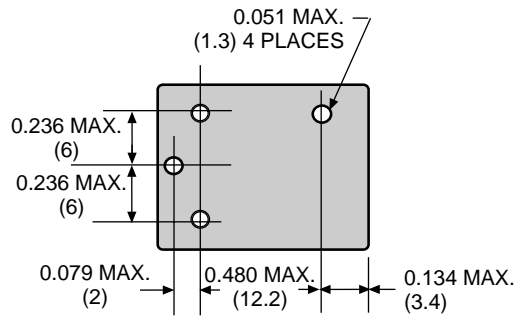

WIRING DIAGRAMS (VIEWED FROM PIN END)

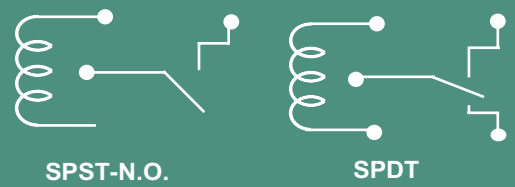

STANDARD PART NUMBERS	CONTACT CONFIGURATION	COIL MEASURED @ 25°C	
		NOMINAL INPUT VOLTAGE	NOMINAL RESISTANCE (OHMS)
15 AMPS			
A178URE1A-3DC	SPST-NO	3 VDC	25 Ω
A178URE1A-5DC	SPST-NO	5 VDC	70 Ω
A178URE1A-12DC	SPST-NO	12 VDC	400 Ω
A178URE1A-24DC	SPST-NO	24 VDC	1600 Ω
A178URE1A-48DC	SPST-NO	48 VDC	4500 Ω
10 AMPS			
A178URE1-3DC	SPDT	3 VDC	25 Ω
A178URE1-5DC	SPDT	5 VDC	70 Ω
A178URE1-12DC	SPDT	12 VDC	400 Ω
A178URE1-24DC	SPDT	24 VDC	1600 Ω
A178URE1-48DC	SPDT	48 VDC	4500 Ω



UL CONTACT LOAD RATINGS TABLE

CONTACT MATERIAL	TYPE	LOAD	VOLTAGE
SIL	3AMP	3 AMP	28 VDC, 120 VAC
		15 AMP	28 VDC, 150 VAC, N. O. ONLY
SCO	5AMP	5 AMP	28 VDC, 120 VAC
		TV-3	120 VAC
		PILOT DUTY	B300 (120/240 VAC)
SCO	10AMP	10 AMP	120/240 VAC
		10AMP	28 VDC
		10AMP	277 VAC
		1/3 HP	120 VAC
			240 VAC, N. O. ONLY
		1/8 HP	277 VAC, N. C. ONLY
		TUNGSTEN	2AMP, 240W, 120 VAC, N. C. ONLY
			5AMP, 600W, 120 VAC, N. O. ONLY
		1/4 HP	277 VAC, N. O. ONLY
		BALLAST	480 VAC @ 277 VAC, SPDT
		1/6 HP	120/240 VAC, N. C. ONLY
		15 AMP	28 VDC, 150 VAC, N. O. ONLY
		480 VAC	2AMP MAX, 240/270 VAC
		PILOT DUTY	B300 (120/240 VAC)
		TV-5	120 VAC, N. O. ONLY
TV-3	120 VAC		

NOTES: SCO = SILVER CADMIUM OXIDE; SIL = SILVER.

SPDT, 3, 5 & 10 AMPS

cULus
UL Recognized
File No. E52197

**MANUFACTURED UNDER
ISO 9002 & QS 9000**

ONLY 1.1 CUBIC INCHES. VARIETY OF MOUNTING CONFIGURATIONS. TAPPED MOUNTING HOLES (49R1C4). TV 5 RATING AVAILABLE. STANDARD PILOT DUTY 240 VAC. MAGNETIC MOTOR CONTROLLER RATING 1/3 HP AT 120VAC.

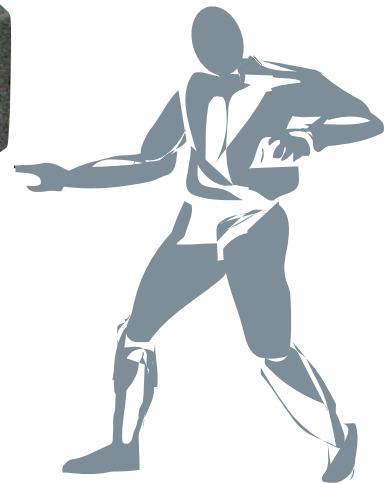
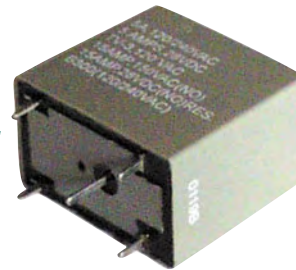

GENERAL SPECIFICATIONS

COIL

Pull-in Voltage: VG, VW adj. (DC) = 75%,
VF, VG adj. (AC) = 80% of nominal coil voltage or less.

Dropout Voltage: 10% of actual pull-in or more

Max. Voltage: 120% max.

Resistance: ±10%

Duty: Continuous

CONTACTS

Contact Material: Silver cad oxide (5, 10 Amp), silver, gold plated (3 Amp).

Contact Resistance: 100 milliohms max. initial value @ 6 VDC, 1 Amp

TIMING

Operate Time: 10 mS typ. (25 mS max.)

Release Time: 7 mS typ. (10 mS max.)

DIELECTRIC STRENGTH

Contacts to Coil: 1,500 V rms

Across Open Contacts: 500 V rms

Coil to Frame: 1,500 V rms

Insulation Resistance: 1000 mΩ min. @ 500 VDC

TEMPERATURE

Operating: -55°C to +85°C

Storage: -55°C to +130°C

VIBRATION RESISTANCE

Functional: 10 to 55 Hz @ 1.65mm displacement

SHOCK RESISTANCE

Functional: 10 g's

Mechanical: 100 g's

LIFE EXPECTANCY

Electrical: 100,000 operations @ rated resistive load

Mechanical: 50,000,000 operations @ no load

MISCELLANEOUS

Soldering Temperature: 270°C (518°F) Max. for 5 seconds max

Operating Position: Any

Enclosure: Dust cover

Weight: 42 g Approx

SPDT, 3, 5 & 10 AMPS

OUTLINE DIMENSIONS
DIMENSIONS SHOWN IN INCHES & (MILLIMETERS).

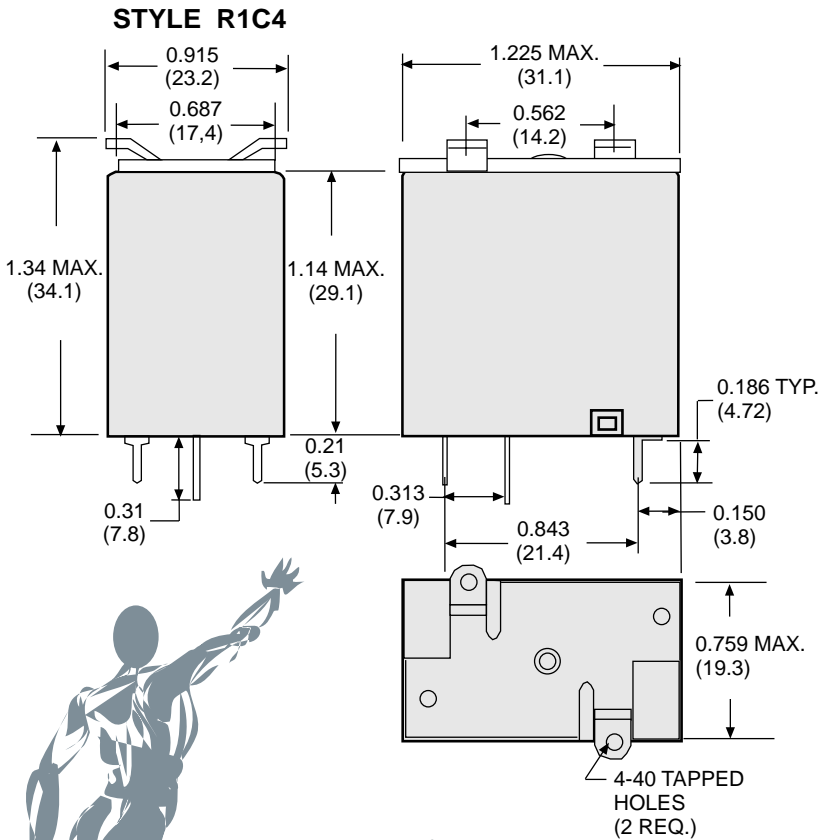
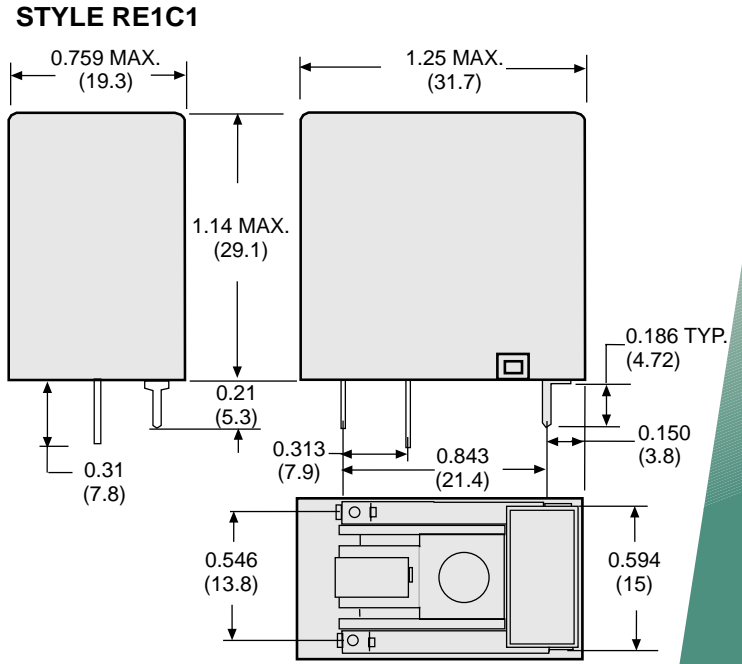
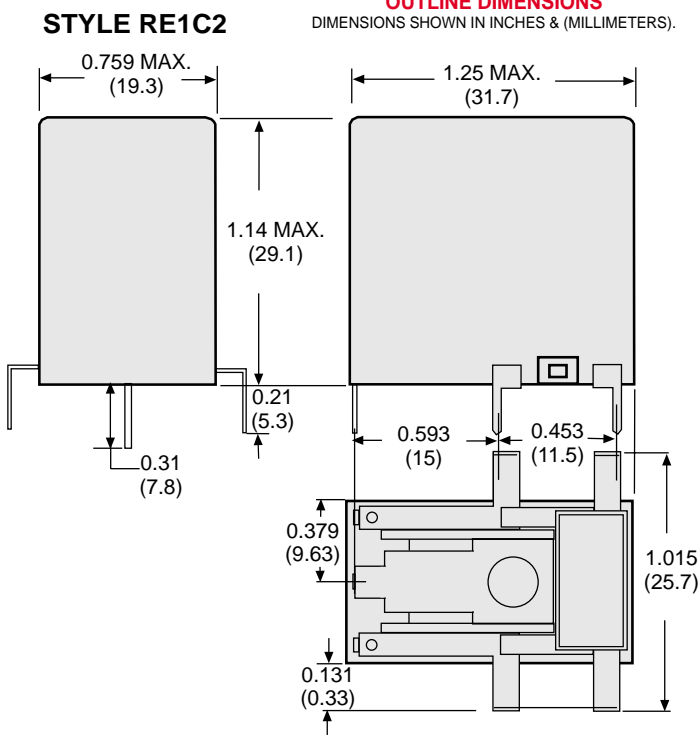

WIRING DIAGRAMS

(VIEWED FROM PIN END)

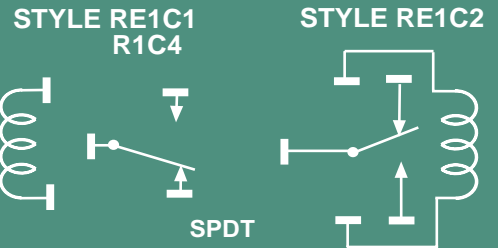

STANDARD PART NUMBERS	CONTACT CONFIGURATION	COIL MEASURED @ 25°C	
		NOMINAL INPUT VOLTAGE	NOMINAL RESISTANCE (OHMS)
3 AMP STYLE RE1C1			
W49RE1C1VG-3DC-SIL	SPDT	3 VDC	90 Ω
W49RE1C1VG-5DC-SIL	SPDT	5 VDC	235 Ω
W49RE1C1VG-12DC-SIL	SPDT	12 VDC	1350 Ω
W49RE1C2VF-6DC-SIL	SPDT	6 VDC	410 Ω
W49RE1C2VF-12DC-SIL	SPDT	12 VDC	1640 Ω
W49RE1C2VF-24DC-SIL	SPDT	24 VDC	6560 Ω
5 AMP STYLE RE1C1 AND RE1C2			
W49RE1C1VG-5DC-SCO	SPDT	5 VDC	235 Ω
W49RE1C1VG-12DC-SCO	SPDT	12 VDC	1350 Ω
W49RE1C1VG-24DC-SCO	SPDT	24 VDC	5400 Ω
W49RE1C2VF-6DC-SCO	SPDT	6 VDC	410 Ω
W49RE1C2VF-12DC-SCO	SPDT	12 VDC	1640 Ω
W49RE1C2VF-24DC-SCO	SPDT	24 VDC	6560 Ω
10 AMP STYLE RE1C1			
W49RE1C1VW-5DC-SCO	SPDT	5 VDC	100 Ω
W49RE1C1VW-12DC-SCO	SPDT	12 VDC	600 Ω
W49RE1C1VW-24DC-SCO	SPDT	24 VDC	2400 Ω
SOLDER TERMINALS, BRACKET MOUNTING 10 AMP STYLE RE1C4			
W49R1C4VG-5DC-SCO	SPDT	5 VDC	235 Ω
W49R1C4VG-12DC-SCO	SPDT	12 VDC	1350 Ω
10 AMP STYLE RE1C4			
W49R1C4VW-5DC-SCO	SPDT	5 VDC	100 Ω
W49R1C4VW-24DC-SCO	SPDT	24 VDC	2400 Ω

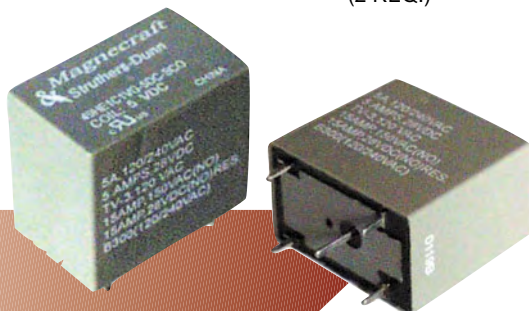
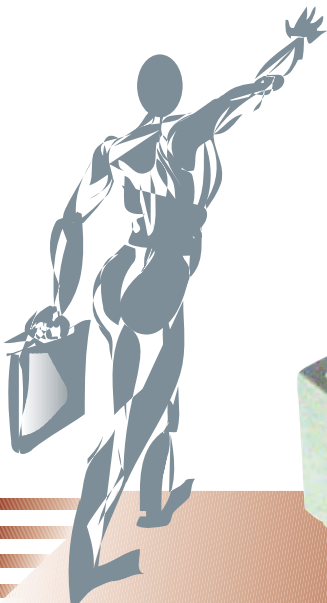

UL CONTACT LOAD RATINGS TABLE

LOAD	LOAD VOLTAGE	DPDT FIGURE " A "	SPDT FIGURE " B "	SPDT FIGURE " C "
RESISTIVE	250 VAC	5 AMP	20 AMP (120 VAC)	12 AMP
	30 VDC	5 AMP	20AMP	12 AMP
	250 VAC	7 AMP (N.O.)	16 AMP (UL - TUV.)	10 AMP(TUV)
	30 VDC	7 AMP (N.O.)	16 AMP (UL - TUV.)	10 AMP(TUV)
INDUCTIVE	250 VAC	*2 AMP	*8 AMP	*5 AMP
	30 VDC	†2 AMP	†8 AMP	†5 AMP
TV		DPST - N.O.	SPST - N.O.	SPDT - N.O.
		TV - 3	TV - 8	TV - 5

* COSØ = 0.4 (TUV)

† L/R = 7mS (TUV)

SPDT & DPDT 5, 12 & 20 AMPS

UL us
UL Recognized
File No. E191122



TUV

**MANUFACTURED UNDER
ISO 9002 & QS 9000**

- * **UL CLASS "F" COIL INSULATION SYSTEM AVAILABLE.**
- * **AC COIL VOLTAGES.**
- * **UL RATED TV-3, TV-5 OR TV-8, N. O. ONLY.**
- * **CONTACTS RATED UP TO 20 AMP.**
- * **8 MILLIMETERS MINIMUM. CLEARANCE. COIL TO CONTACTS.**
- * **DIELECTRIC STRENGTH: 5,000 V rms.**



GENERAL SPECIFICATIONS

COIL

Pull-in Voltage: 85% of nominal voltage or less for AC
75% of nominal voltage or less for DC

Dropout Voltage: 30% min. of nominal voltage or more for AC
10% min. of nominal voltage or more for DC

Max. Voltage: 110%

Resistance: ±10% measured @ 25°C

Coil Power: AC 1.2 VA, DC 0.54 watts
@ nominal voltage

Insulation System: Class "B" (130°C per UL standart 1446)
Class "F" available

Max. Coil Dissipation: 1.5 VA (60Hz) @ 25°C

Duty: Continuous

CONTACTS

Contact Material: Silver cadmium oxide

Contact Rating: See:
"UL CONTACT LOAD RATINGS TABLE"

Contact Resistance: 100 milliohms min

TIMING

Operate Time: 15 mS max. @ nominal voltage

Release Time: 10 mS max. @ nominal voltage

DIELECTRIC STRENGTH

Contacts to Coil: 5000 V rms; (8 mm creepage & clearance)

Across Open Contacts: 1000 V rms

Pole to Pole: 2500 V rms

Insulation Resistance: 100 megohms 500 VDC

TEMPERATURE

Operating: -20°C to +55°C

Storage: -40°C to +80°C

VIBRATION RESISTANCE

Functional: 10 to 55 Hz dual amplitude 1.5 mm

SHOCK RESISTANCE

Functional: 10 g's (11mS)

Mechanical: 100 g's (6mS)

LIFE EXPECTANCY

Electrical: 100,000 operations
@ rated resistive load

Mechanical: 10,000,000 operations @ no load

MISCELLANEOUS

Operating Position: Any

Enclosure: Plastic, epoxy sealed, suitable for automatic circuit board processing. After cleaning process, pierce a small hole in cover for venting

Weight: 17 grams approx.

SPDT & DPDT 5, 12 & 20 AMPS

OUTLINE DIMENSIONS
DIMENSIONS SHOWN IN INCHES & (MILLIMETERS).

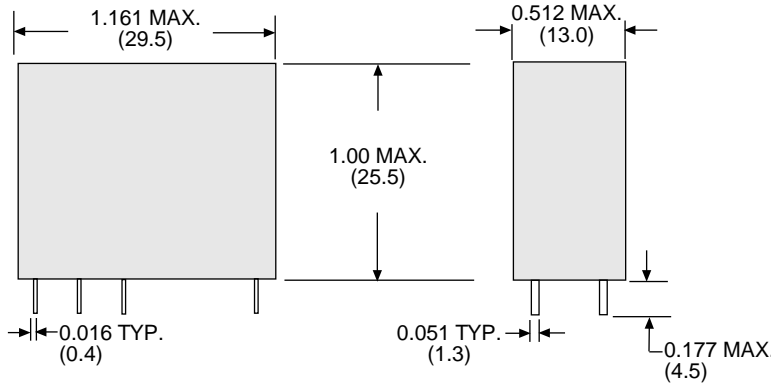

PRINTED CIRCUIT MOUNTING HOLE LAYOUT
(BOTTOM VIEW)

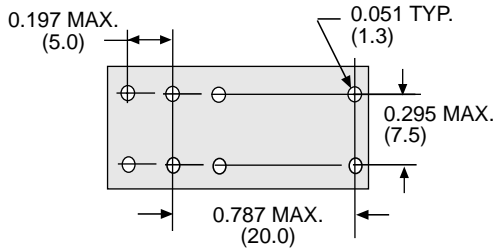

FIG. "A"

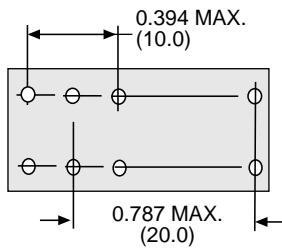

FIG. "B"

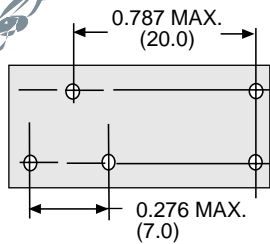
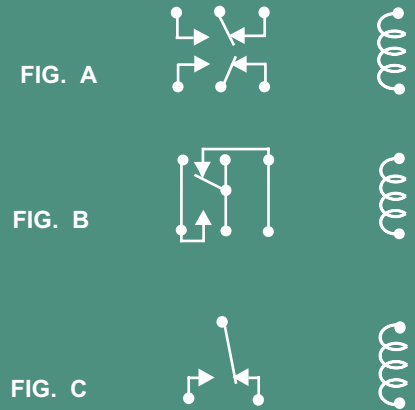

FIG. "C"



WIRING DIAGRAMS
(VIEWED FROM PIN END)



COIL MEASURED @ 25 °C

STANDARD PART NUMBERS	CONTACT CONFIGURATION	NOMINAL INPUT VOLTAGE	NOMINAL RESISTANCE (OHMS & VA)
DC OPERATED COIL, FIG. A			
976XBXH-5D / 76EURPCPX-61	DPDT	5 VDC	47 Ω
976XBXH-6D / 76EURPCPX-62	DPDT	6 VDC	68 Ω
976XBXH-12D / 76EURPCPX-63	DPDT	12 VDC	270 Ω
976XBXH-24D / 76EURPCPX-64	DPDT	24 VDC	1100 Ω
DC OPERATED COIL, FIG. B			
976XAX97H-5D / 76EURPCPX-146	SPDT	5 VDC	47 Ω
976XAX97H-6D / 76EURPCPX-147	SPDT	6 VDC	68 Ω
976XAX97H-12D / 76EURPCPX-148	SPDT	12 VDC	270 Ω
976XAX97H-24D / 76EURPCPX-149	SPDT	24 VDC	1100 Ω
DC OPERATED COIL, FIG. C			
976XAXH-5D / 76EURPCPX-14	SPDT	5 VDC	68 Ω
976XAXH-6D / 76EURPCPX-15	SPDT	6 VDC	270 Ω
976XAXH-12D / 76EURPCPX-16	SPDT	12 VDC	1100 Ω
976XAXH-24D / 76EURPCPX-17	SPDT	24 VDC	4400 Ω
AC OPERATED COIL, FIG. A			
976XBXH-24A	DPDT	24 VAC	250 Ω
976XBXH-120A	DPDT	120 VAC	5,600 Ω
976XBXH-240A	DPDT	240 VAC	22000 Ω
AC OPERATED COIL, FIG. B			
976XAX97H-24A	SPDT	24 VAC	250 Ω
976XAX97H-120A	SPDT	120 VAC	5,600 Ω
976XAX97H-240A	SPDT	240 VAC	22000 Ω
AC OPERATED COIL, FIG. C			
976XAXH-24A	SPDT	24 VAC	250 Ω
976XAXH-120A	SPDT	120 VAC	5,600 Ω
976XAXH-240A	SPDT	240 VAC	22000 Ω

OTHER COIL VOLTAGES ARE AVAILABLE ON SPECIAL ORDER.
CONTACT FACTORY FOR SPECIAL REQUIREMENTS.

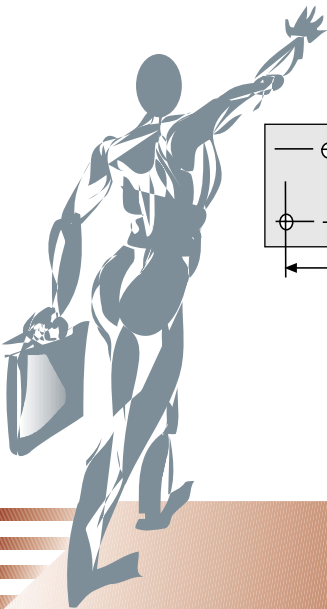

UL CONTACT LOAD RATINGS TABLE

LOAD	LOAD VOLTAGE/ CURRENT	SPST-NO	SPDT
RESISTIVE	240 VAC 30 VDC	10 AMP 10 AMP	7 AMP 7 AMP
MOTOR	120 VAC	1/6 HP	1/10 HP
*POWER	WATTS (VDC) VA	300 WATTS 2500 VA	210 WATTS 1750 VA

* Voltage and Power Ratings in the table Above are Independent Maximums and no Single Value is to be Exceeded.

DTL COMPATIBLE SINGLE-SIDE STABLE DESIGN.
5KV SURGE RESISTANCE COIL TO CONTACT MEETS
INTERNATIONAL SPACING OF 4 mm.

GENERAL SPECIFICATIONS

COIL

Pull-in Voltage: 70% of nominal voltage or less
 Dropout Voltage: 10% of nominal voltage or more
 Max. Voltage: 110%
 Resistance: ±10%
 Coil Power: 200 mW approx

CONTACTS

Contact Material: Silver alloy
 Contact Resistance: 100 milliohms initial @ 6 VDC, 1 Amp

TIMING

Operate Time: 10 mS max. @ nominal voltage
 Release Time: 10 ms max. @ nominal voltage

DIELECTRIC STRENGTH

Contacts to Coil: 2000 V rms
 Across Open Contacts: 1000 V rms
 Surge Voltage Resistance: 5000 V rms between coil and contacts
 Insulation Resistance: 500 VDC exceeds 1000 megohms min

TEMPERATURE

Operating: -40°C to +70°C
 Storage: -40°C to +100°C

VIBRATION RESISTANCE

Functional: 10 to 55Hz, dual amplitude 1.5 mm

SHOCK RESISTANCE

Functional: 100g's 6 mS no damage

LIFE EXPECTANCY

Electrical: 100,000 operations @ rated resistive load
 Mechanical: 10,000,000 operations @ no load

MISCELLANEOUS

Operating Position: Any
 Enclosure: Plastic cover, epoxy sealed
 Weight: 5.5 grams approx.

SPST-N.O. & SPDT 10 AMPS

MANUFACTURED UNDER
 ISO 9002



OUTLINE DIMENSIONS
 DIMENSIONS SHOWN IN INCHES & (MILLIMETERS).

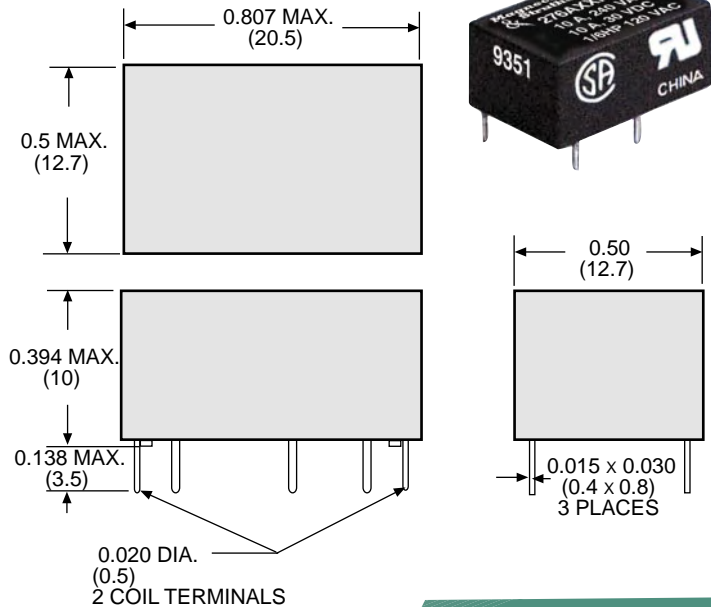

WIRING DIAGRAM
 (VIEWED FROM PIN END)

PRINTED CIRCUIT MOUNTING HOLE LAYOUT
 (TOP VIEW SHOWN AT ACTUAL SIZE ON 0.1 GRID)

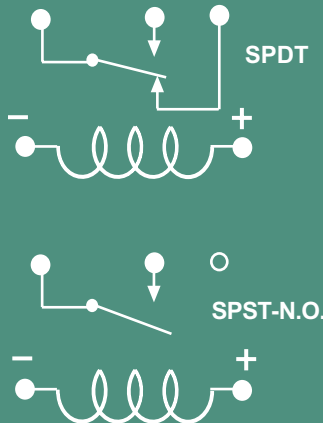
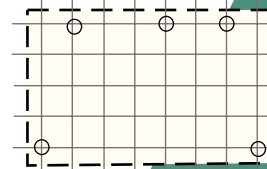

COIL MEASURED @ 25°C

STANDARD PART NUMBERS	CONTACT CONFIGURATION	NOMINAL INPUT VOLTAGE	NOMINAL RESISTANCE (OHMS)
276AXXH-5D	SPST-NO	5 VDC	125 Ω
276AXXH-6D	SPST-NO	6 VDC	180 Ω
276AXXH-12D	SPST-NO	12 VDC	720 Ω
276AXXH-24D	SPST-NO	24 VDC	2880 Ω
276XAXH-5D	SPDT	5 VDC	125 Ω
276XAXH-6D	SPDT	6 VDC	180 Ω
276XAXH-12D	SPDT	12 VDC	720 Ω
276XAXH-24D	SPDT	24 VDC	2880 Ω



SECTION 7 CROSS REFERENCE GUIDE

MAGNECRAFT & STRUTHERS-DUNN	AROMAT	AMERICAN ZETTLER	OMRON	POTTER & BRUMFIELD
W90S1D12-5		AZ2150(or 2151)-1A-5DE	G8P-1A4-DC5	T90S1D12-5 (CLASS F)
W90S1D12-12		AZ2150(or 2151)-1A-12DE	G8P-1A4-DC12	T90S1D12-12 (CLASS F)
W90S1D12-24		AZ2150(or 2151)-1A-24DE	G8P-1A4-DC24	T90S1D12-24 (CLASS F)
W90S1D12-110		AZ2150(or 2151)-1A-110DE	G8P-1A4-DC110	T90S1D12-110 (CLASS F)
W90S5D12-5		AZ2150(or 2151)-1C-5DE	G8P-1C4-DC5	T90S5D12-5 (CLASS F)
W90S5D12-12		AZ2150(or 2151)-1C-12DE	G8P-1C4-DC12	T90S5D12-12 (CLASS F)
W90S5D12-24		AZ2150(or 2151)-1C-24DE	G8P-1C4-DC24	T90S5D12-24 (CLASS F)
W90S5D12-110		AZ2150(or 2151)-1C-110DE	G8P-1C4-DC110	T90S5D12-110 (CLASS F)
W90S1D42-5	JTN1aE-PA-F-DC5V	AZ2150(or 2151)-1A-5DEF	G8P-1A4-CF-DC5	T90S1D42-5
W90S1D42-12	JTN1aE-PA-F-DC12V	AZ2150(or 2151)-1A-12DEF	G8P-1A4-CF-DC12	T90S1D42-12;T9AS1D12-12
W90S1D42-24	JTN1aE-PA-F-DC24V	AZ2150(or 2151)-1A-24DEF	G8P-1A4-CF-DC24	T90S1D42-24 T9AS1D12-24
W90S1D42-110		AZ2150(or 2151)-1A-110DEF	G8P-1A4-CF-DC110	T90S1D42-110
W90S5D42-5	JTN1E-PA-F-DC5V	AZ2150(or 2151)-1C-5DEF	G8P-1C4-CF-DC5	T90S5D42-5
W90S5D42-12	JTN1E-PA-F-DC12V	AZ2150(or 2151)-1C-12DEF	G8P-1C4-CF-DC12	T90S5D42-12
W90S5D42-24	JTN1E-PA-F-DC24V	AZ2150(or 2151)-1C-24DEF	G8P-1C4-CF-DC24	T90S5D42-24
W90S5D42-110		AZ2150(or 2151)-1C-110DEF	G8P-1C4-CF-DC110	T90S5D42-110
MAGNECRAFT & STRUTHERS-DUNN	AROMAT	AMERICAN ZETTLER		POTTER & BRUMFIELD
W9AS1D22-5	JTN1aE-TMP-F-DC5V	AZ2100-1A-5DEF		T9AS1D22-5
W9AS1D22-12	JTN1aE-TMP-F-DC12V	AZ2100-1A-12DEF		T9AS1D22-12
W9AS1D22-24	JTN1aE-TMP-F-DC24V	AZ2100-1A-24DEF		T9AS1D22-24
W9AS1D22-48	JTN1aE-TMP-F-DC48V	AZ2100-1A-48DEF		T9AS1D22-48
W9AS1D22-110	JTN1aE-TMP-F-DC110V	AZ2100-1A-110DEF		T9AS1D22-110
W9AS5D22-5	JTN1E-TMP-F-DC5V	AZ2100-1C-5DEF		T9AS5D22-5
W9AS5D22-12	JTN1E-TMP-F-DC12V	AZ2100-1C-12DEF		T9AS5D22-12
W9AS5D22-24	JTN1E-TMP-F-DC24V	AZ2100-1C-24DEF		T9AS5D22-24
W9AS5D22-48	JTN1E-TMP-F-DC48V	AZ2100-1C-48DEF		T9AS5D22-48
W9AS5D22-110	JTN1E-TMP-F-DC110V	AZ2100-1C-110DE		T9AS5D22-110
MAGNECRAFT & STRUTHERS-DUNN		AMERICAN ZETTLER	OMRON	POTTER & BRUMFIELD
W92S7A12-24		AZ2850-2A-24A	G7L-2A-P-CB-AC24	T92S7A12-24
W92S7A12-120		AZ2850-2A-120A	G7L-2A-P-CB-AC120	T92S7A12-120
W92S7A12-240		AZ2850-2A-240A	G7L-2A-P-CB-AC240	T92S7A12-240
W92S11A12-24		AZ2850-2C-24A		T92S11A12-24
W92S11A12-120		AZ2850-2C-120A		T92S11A12-120
W92S11A12-240		AZ2850-2C-240A		T92S11A12-240
W92S7D12-12		AZ2800-2A-12D	G7L-2A-P-CB-DC12	T92S7D12-12
W92S7D12-24		AZ2800-2A-24D	G7L-2A-P-CB-DC24	T92S7D12-24
W92S7D12-48		AZ2800-2A-48D	G7L-2A-P-CB-DC48	T92S7D12-120
W92S7D12-110		AZ2800-2A-110D	G7L-2A-P-CB-DC110	T92S7D12-240
W92S11D12-12		AZ2800-2C-12D		T92S11D12-12
W92S11D12-24		AZ2800-2C-24D		T92S11D12-24
W92S11D12-48		AZ2800-2C-48D		T92S11D12-120
W92S11D12-110		AZ2800-2C-110D		T92S11D12-240
MAGNECRAFT & STRUTHERS-DUNN	MIDTEX			
W7PCX-1	MMS105			
W7PCX-3	MMS102			

THE CROSS REFERENCE IS INTENDED TO MATCH FOOT PRINT, INTERNAL WIRING, AND CONTACT LOAD RATINGS. CONSTRUCTION FEATURES AND GENERAL SPECIFICATIONS SHOULD BE COMPARED IF EXACT REPLACEMENT IS REQUIRED.



SECTION 7 CROSS REFERENCE GUIDE

MAGNECRAFT & STRUTHERS-DUNN	MIDTEX			
W7PCX-4	MMS124			
W7PCX-5	MMS205			
W7PCX-7	MMS212			
W7PCX-8	MMS224			
MAGNECRAFT & STRUTHERS-DUNN				POTTER & BRUMFIELD
W60HE1S-5DC				R50E2Y1-5V
W60HE1S-12DC				R50E2Y1-12V
W60HE1S-24DC				R50E2Y1-24V
W60HE1S-48DC				R50E2Y1-48V
W60HE2S-5DC				R50E2Y2-5V
W60HE2S-12DC				R50E2Y2-12V
W60HE2S-24DC				R50E2Y2-24V
W60HE2S-48DC				R50E2Y2-48V
MAGNECRAFT & STRUTHERS-DUNN	AROMAT	AMERICAN ZETTLER	OMRON	POTTER & BRUMFIELD
A178URE1A-3DC	NOT AVAILABLE	NOT AVAILABLE	G5LE-1A4(as is or ACD, or-ASI)-DC3	T7NS1D1-3
A178URE1A-5DC	JS1a-5V	NOT AVAILABLE	G5LE-1A4(as is or ACD, or-ASI)-DC5	T7NS1D1-5
A178URE1A-12DC	JS1a-12V	NOT AVAILABLE	G5LE-1A4(as is or ACD, or-ASI)-DC12	T7NS1D1-12
A178URE1A-24DC	JS1a-24V	NOT AVAILABLE	G5LE-1A4(as is or ACD, or-ASI)-DC24	T7NS1D1-24
A178URE1A-48DC	JS1a-48V	NOT AVAILABLE	G5LE-1A4(as is or ACD, or-ASI)-DC48	T7NS1D1-48
A178URE1-3DC	NOT AVAILABLE	NOT AVAILABLE	G5LE-14(as is or ACD, or-ASI)-DC3	T7NS5D1-3
A178URE1-5DC	JS1-5V	AZ941-1CT-5DEB	G5LE-14(as is or ACD, or-ASI)-DC5	T7NS5D1-5
A178URE1-12DC	JS1-12V	AZ941-1CT-12DEB	G5LE-14(as is or ACD, or-ASI)-DC12	T7NS5D1-12
A178URE1-24DC	JS1-24V	AZ941-1CT-24DEB	G5LE-14(as is or ACD, or-ASI)-DC24	T7NS5D1-24
A178URE1-48DC	JS1-48V	AZ941-1CT-48DEB	G5LE-14(as is or ACD, or-ASI)-DC48	T7NS5D1-48
MAGNECRAFT & STRUTHERS-DUNN				CORNELL DUBILIER
W49RE1C1VG-3DC-SIL				653-3K
W49RE1C1VG-5DC-SIL				653-6K
W49RE1C1VG-12DC-SIL				653-12K
W49RE1C1VG-5DC-SCO				603-6B
W49RE1C1VG-12DC-SCO				603-12B
W49RE1C1VG-24DC-SCO				603-24B
W49RE1C1VW-5DC-SCO				613-6B
W49RE1C1VW-12DC-SCO				613-12B
W49RE1C1VW-24DC-SCO				613-24B
MAGNECRAFT & STRUTHERS-DUNN	AROMAT	AMERICAN ZETTLER	OMRON	POTTER & BRUMFIELD
976XBXH-5D / 76EURCPCX-61	JW2SN-DC5V	AZ733-2C-5DE	G2R-24-DC5	RTE24005F
976XBXH-6D / 76EURCPCX-62	JW2SN-DC6V	AZ733-2C-6DE	G2R-24-DC6	RTE24006F
976XBXH-12D / 76EURCPCX-63	JW2SN-DC12V	AZ733-2C-12DE	G2R-24-DC12	RTE24012F
976XBXH-24D / 76EURCPCX-64	JW2SN-DC24V	AZ733-2C-24DE	G2R-24-DC24	RTE24024F
976XAX97H-5D / 76EURCPCX-146	NOT AVAILABLE	AZ755-1C-5DE	G2R-1-E-DC5	RTD14005F
976XAX97H-6D / 76EURCPCX-147	NOT AVAILABLE	AZ755-1C-6DE	G2R-1-E-DC6	RTD14006F
976XAX97H-12D / 76EURCPCX-148	NOT AVAILABLE	AZ755-1C-12DE	G2R-1-E-DC12	RTD14012F
976XAX97H-24D / 76EURCPCX-149	NOT AVAILABLE	AZ755-1C-24DE	G2R-1-E-DC24	RTD14024F
976XAX97H-48D / 76EURCPCX-150	NOT AVAILABLE	AZ755-1C-48DE	G2R-1-E-DC48	RTD14048F

THE CROSS REFERENCE IS INTENDED TO MATCH FOOT PRINT, INTERNAL WIRING, AND CONTACT LOAD RATINGS. CONSTRUCTION FEATURES AND GENERAL SPECIFICATIONS SHOULD BE COMPARED IF EXACT REPLACEMENT IS REQUIRED.



SECTION 7 CROSS REFERENCE GUIDE

MAGNECRAFT & STRUTHERS-DUNN	AROMAT	AMERICAN ZETTLER	OMRON	POTTER & BRUMFIELD
976XAXH-5D / 76EURPCPX-14	JW1FSN-DC5V	NOT AVAILABLE	G2R-14-DC5	RTB14005F
976XAXH-6D / 76EURPCPX-15	JW1FSN-DC6V	NOT AVAILABLE	G2R-14-DC6	RTB14006F
976XAXH-12D / 76EURPCPX-16	JW1FSN-DC12V	NOT AVAILABLE	G2R-14-DC12	RTB14012F
976XAXH-24D / 76EURPCPX-17	JW1FSN-DC24V	NOT AVAILABLE	G2R-14-DC24	RTB14024F
976XAXH-48D / 76EURPCPX-18	JW1FSN-DC48V	NOT AVAILABLE	G2R-14-DC48	RTB14048F
110VDC COIL AVAILABLE ON CLASS 976				
976XBXH-24A			G2R-24-AC24	RTE24524
976XBXH-120A			G2R-24-AC120	RTE24615
976XBXH-240A			G2R-24-AC240	RTE24730
976XAX97H-24A			G2R-1-E-AC24	RTD34524
976XAX97H-120A			G2R-1-E-AC120	RTD34615
976XAX97H-240A			G2R-1-E-AC240	RTD34730
976XAXH-24A			G2R-14-AC24	RTB14524
976XAXH-120A			G2R-14-AC120	RTB14615
976XAXH-240A			G2R-14-AC240	RTB14730
MAGNECRAFT & STRUTHERS-DUNN	GUARDIAN			
W1330P-2C-24A	1330P-2C-24A			
W1330P-2C-120A	1330P-2C-120A			
W1335P-2C-12D	1335P-2C-12D			
W1335P-2C-24D	1335P-2C-24D			

THE CROSS REFERENCE IS INTENDED TO MATCH FOOT PRINT, INTERNAL WIRING, AND CONTACT LOAD RATINGS. CONSTRUCTION FEATURES AND GENERAL SPECIFICATIONS SHOULD BE COMPARED IF EXACT REPLACEMENT IS REQUIRED.

FOR PRINTED CIRCUIT BOARD RELAYS APPLICATION ENGINEERING ASSISTANCE

Zhuhong Tang, PRODUCT MANAGER

FAX: (847) 441-2522

EMAIL: zhtang@magnecraft.com

FAX ON DEMAND: 1-800-891-2957

DOCUMENT: 500

U. S. A.

TELEPHONE: (843) 393-5778

FAX: (843) 393-4123

WEBSITE: www.magnecraft.com

EMAIL: info@magnecraft.com

EUROPE

TELEPHONE: 4989 / 75080310

FAX: 4989 / 7559344

WEBSITE: www.magnecraft.com

EMAIL: renatesteinback@magnecraft.de

Компания «Океан Электроники» предлагает заключение долгосрочных отношений при поставках импортных электронных компонентов на взаимовыгодных условиях!

Наши преимущества:

- Поставка оригинальных импортных электронных компонентов напрямую с производств Америки, Европы и Азии, а так же с крупнейших складов мира;
- Широкая линейка поставок активных и пассивных импортных электронных компонентов (более 30 млн. наименований);
- Поставка сложных, дефицитных, либо снятых с производства позиций;
- Оперативные сроки поставки под заказ (от 5 рабочих дней);
- Экспресс доставка в любую точку России;
- Помощь Конструкторского Отдела и консультации квалифицированных инженеров;
- Техническая поддержка проекта, помощь в подборе аналогов, поставка прототипов;
- Поставка электронных компонентов под контролем ВП;
- Система менеджмента качества сертифицирована по Международному стандарту ISO 9001;
- При необходимости вся продукция военного и аэрокосмического назначения проходит испытания и сертификацию в лаборатории (по согласованию с заказчиком);
- Поставка специализированных компонентов военного и аэрокосмического уровня качества (Xilinx, Altera, Analog Devices, Intersil, Interpoint, Microsemi, Actel, Aeroflex, Peregrine, VPT, Syfer, Eurofarad, Texas Instruments, MS Kennedy, Miteq, Cobham, E2V, MA-COM, Hittite, Mini-Circuits, General Dynamics и др.);

Компания «Океан Электроники» является официальным дистрибьютором и эксклюзивным представителем в России одного из крупнейших производителей разъемов военного и аэрокосмического назначения «JONHON», а так же официальным дистрибьютором и эксклюзивным представителем в России производителя высокотехнологичных и надежных решений для передачи СВЧ сигналов «FORSTAR».



JONHON

«JONHON» (основан в 1970 г.)

Разъемы специального, военного и аэрокосмического назначения:

(Применяются в военной, авиационной, аэрокосмической, морской, железнодорожной, горно- и нефтедобывающей отраслях промышленности)

«FORSTAR» (основан в 1998 г.)

ВЧ соединители, коаксиальные кабели,
кабельные сборки и микроволновые компоненты:

(Применяются в телекоммуникациях гражданского и специального назначения, в средствах связи, РЛС, а так же военной, авиационной и аэрокосмической отраслях промышленности).



Телефон: 8 (812) 309-75-97 (многоканальный)

Факс: 8 (812) 320-03-32

Электронная почта: ocean@oceanchips.ru

Web: <http://oceanchips.ru/>

Адрес: 198099, г. Санкт-Петербург, ул. Калинина, д. 2, корп. 4, лит. А