

REVISIONS				
P.	LTM	DESCRIPTION	DATE	APPROV
H5		ADD NEW DASH NUMBER	24APR2014	CZ SZ

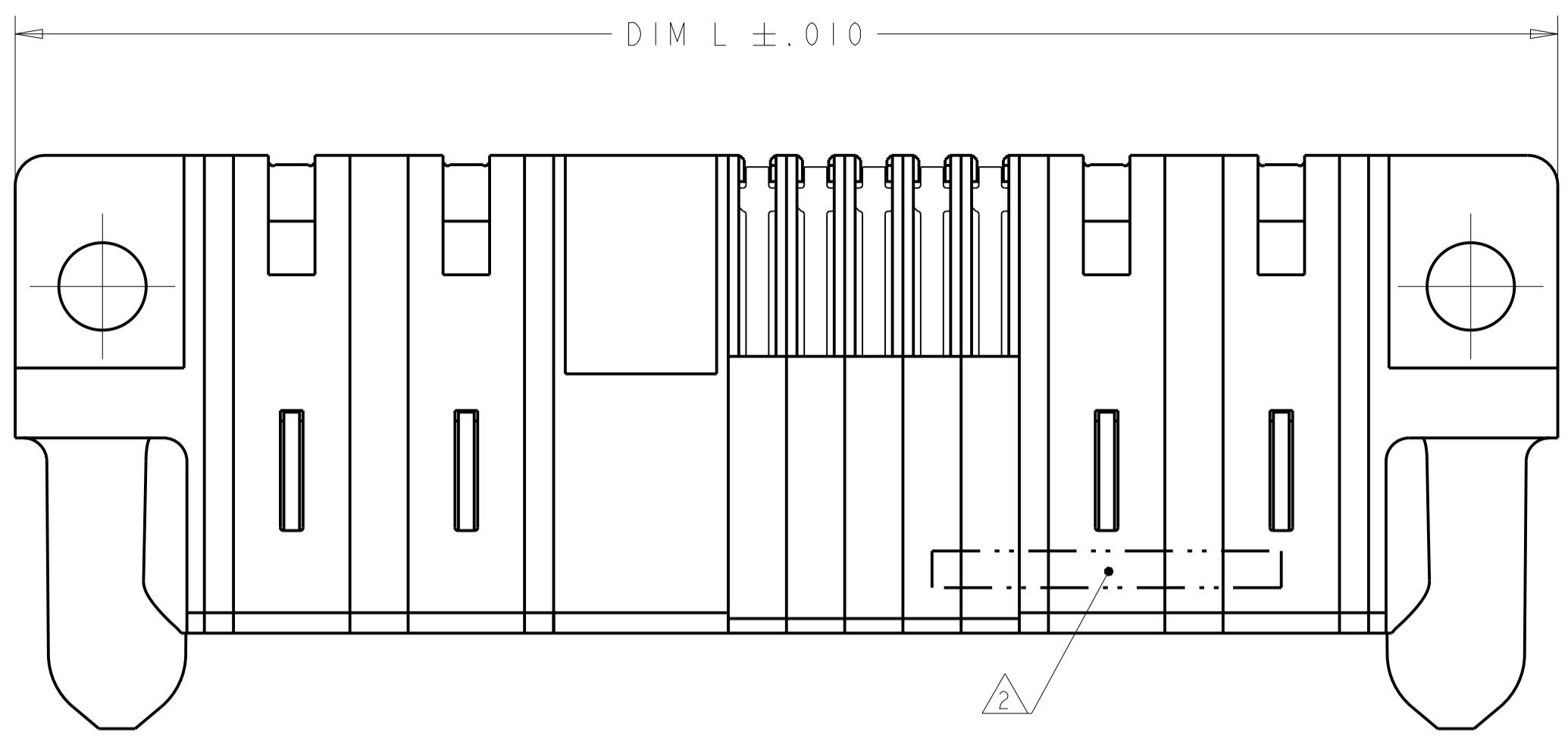

- 1 OPTIONAL CENTER MODULE, WITH .150 THRU HOLE OR HOLD DOWN FEATURE.
- 2 "AMP", PART NUMBER, AND DATE CODE TO BE MARKED IN AREA SHOWN.
- 3 MATERIAL: HOUSING - GLASS FILLED HIGH TEMP THERMO PLASTIC, UL94 V-O, BLACK.
 SIGNAL CONTACT - HIGH CONDUCTIVITY COPPER ALLOY
 POWER CONTACT - HIGH CONDUCTIVITY COPPER ALLOY
- 4 CONTACT PLATING: NOBLE METAL PLATING ON CONTACT FUNCTIONAL AREA OF POWER AND SIGNAL CONTACTS
- 5 MECHANICAL CONNECTOR KEEP OUT ZONE.
- 6 DATUM AND BASIC DIMENSIONS ESTABLISHED BY CUSTOMER.
- 7 PCB - ALL HOLE DIAMETERS ARE FINISHED HOLE SIZES.
- 8 PCB - 0.0453 +/- .0010 DRILLED HOLES PLATED WITH .0003 MIN. Sn OVER .001 TO .003 CU PLATING TO ACHIEVE A .040±.003 HOLE.
- 9 VARIABLE DIMENSION SHOW ON VIEW (SHEET 3).

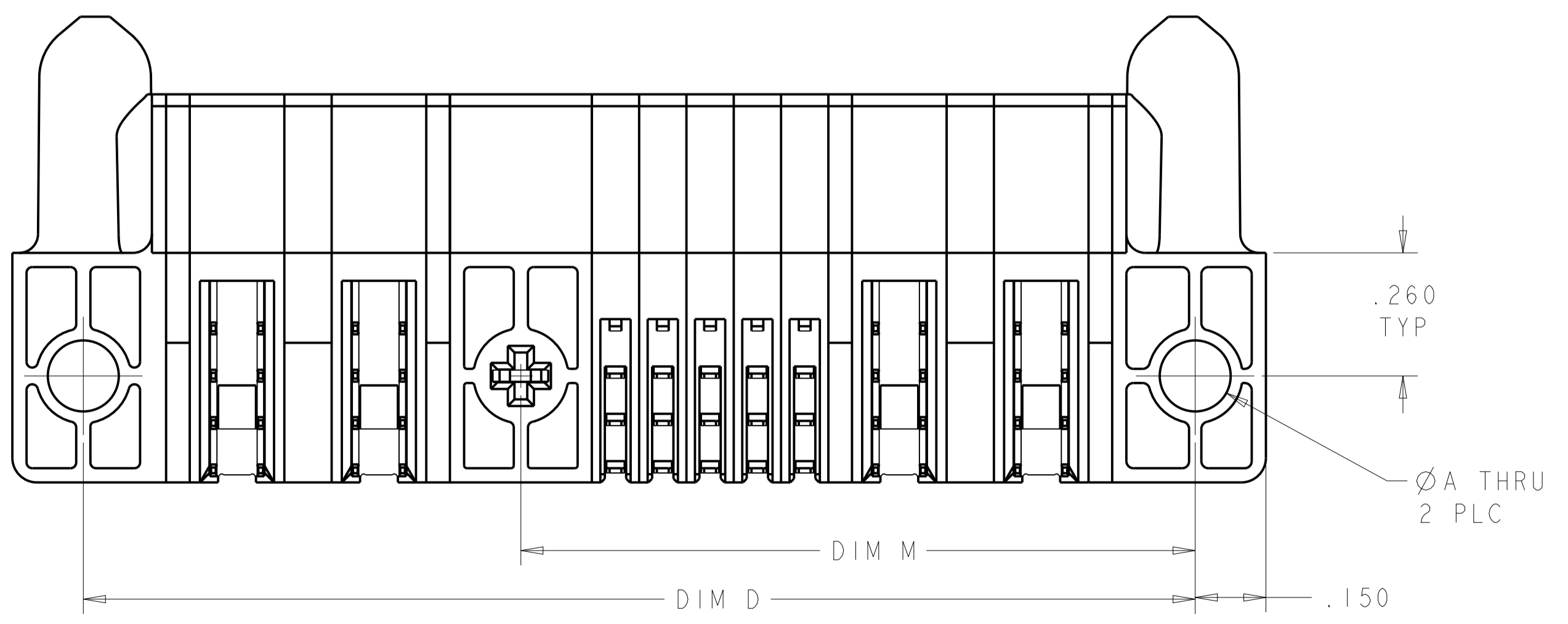
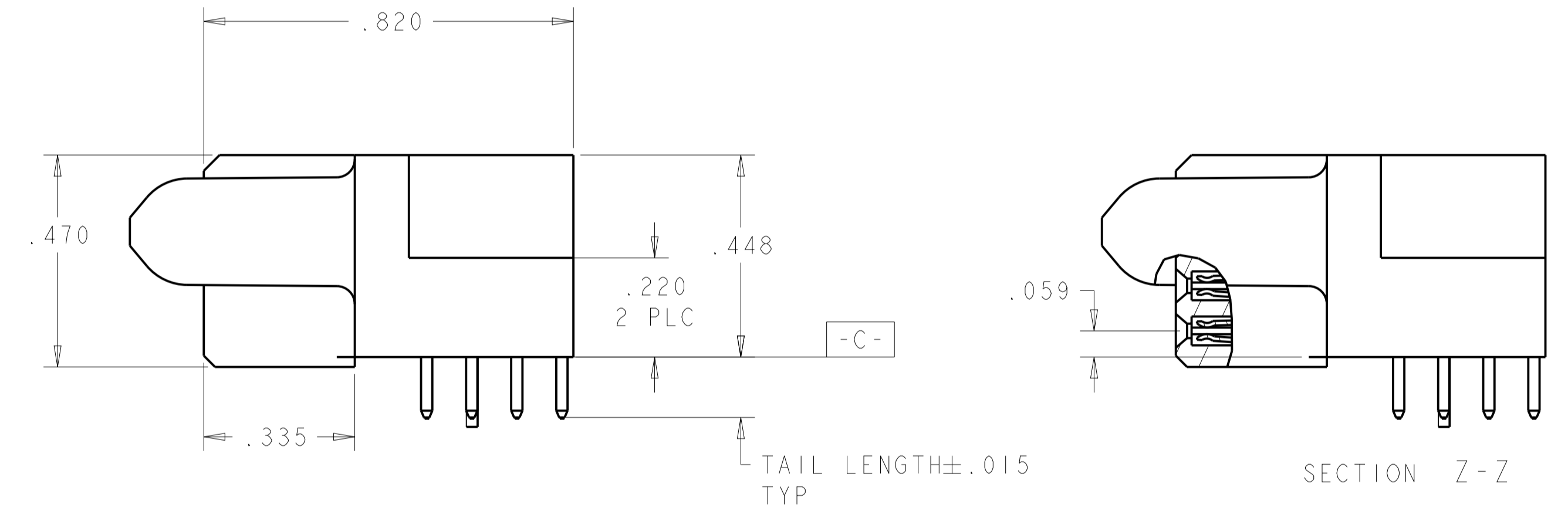
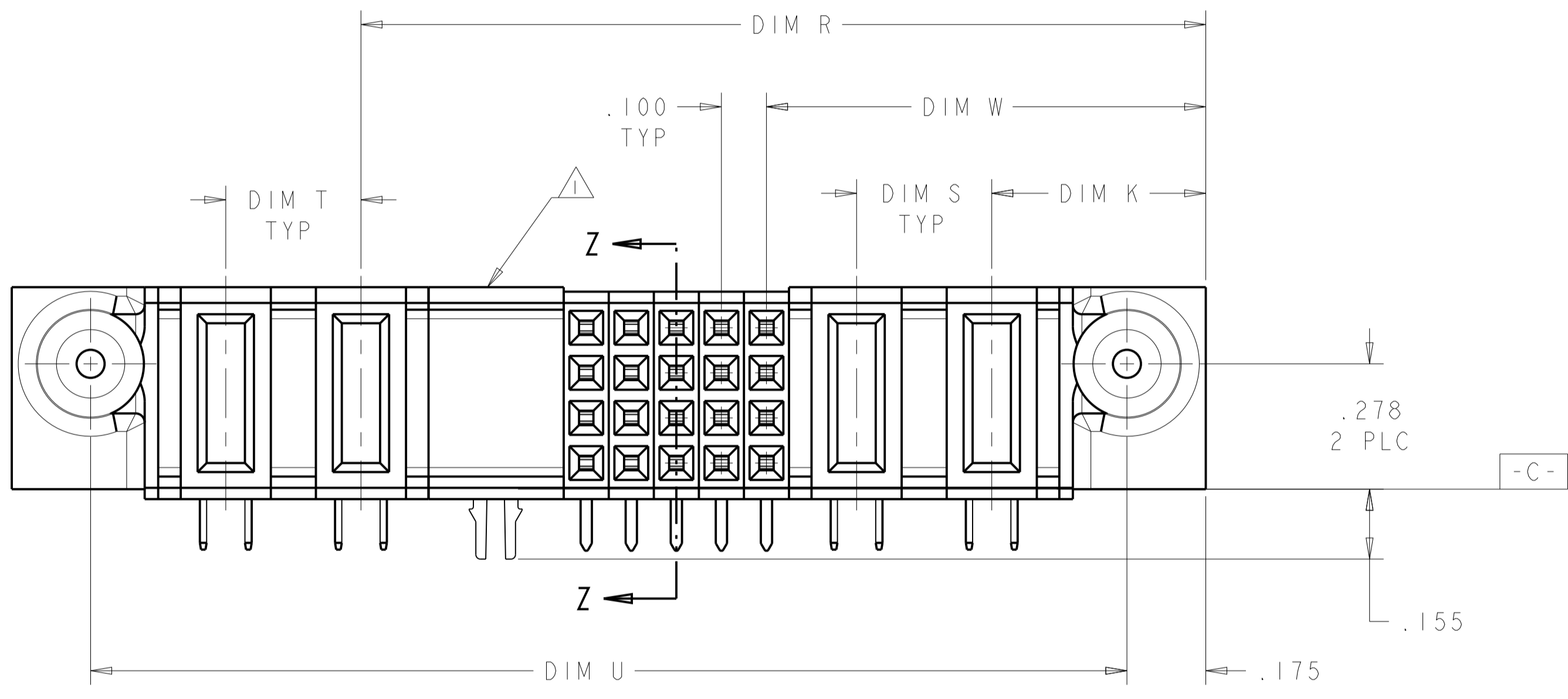

DIM A	DIM T	DIM S	DIM U	DIM R	DIM W	DIM D	DIM M	DIM L	DIM K	DESCRIPTION	PART NUMBER
.122	-	.250	2.750	2.650	1.375	2.800	-	3.100	.450	4P + 48S + 1P	1-6450360-6
.122	-	.200	2.700	2.600	1.425	2.750	-	3.050	.450	5P+44S+1P	1-6450360-5
.150	.200	.200	1.600	1.300	.825	1.650	-	1.950	.450	2HDP + 16S + 2HDP	1-6450360-4
.150	.200	.200	2.400	2.100	.825	2.450	-	2.750	.450	2P + 48S + 2P	1-6450360-3
.150	-	-	1.200	1.100	.625	1.250	-	1.550	.450	1P + 16S + 1P	1-6450360-2
.150	9	.250	2.550	1.550	.875	2.600	-	2.900	.450	2P + 24S + 1P + 3ACP	1-6450360-1
.150	.200	9	2.750	1.450	1.175	2.800	-	3.100	.450	3P + 8S + 7HDP	1-6450360-0
.150	.300	.250	3.200	2.475	1.875	3.250	-	3.550	.450	6P + 16S + 3ACP	6450360-9
.150	.250	.250	1.600	1.250	.925	1.650	-	1.950	.450	2P + 8S + 2P	6450360-8
.150	.250	.250	1.600	1.250	.875	1.650	-	1.950	.450	2P + 12S + 2P	6450360-7
.150	.300	.300	2.000	1.575	.975	2.050	-	2.350	.475	2P + 20S + 2P	6450360-1
DIM A	DIM T	DIM S	DIM U	DIM R	DIM W	DIM D	DIM M	DIM L	DIM K	DESCRIPTION	PART NUMBER

THIS DRAWING IS A CONTROLLED DOCUMENT.

DIMENSIONS: INCHES

TOLERANCES UNLESS OTHERWISE SPECIFIED:

0 PLC	±
1 PLC	±.01
2 PLC	±.01
3 PLC	±.005
4 PLC	±.002
ANGLES	±.020

MATERIAL: 3

FINISH: 4

THIS DRAWING IS A CONTROLLED DOCUMENT. DWN: R. GRZYBOWSKI, CHK: M. PERCHERKE, APVD: M. PERCHERKE

OBAPROS

OBAPROS

NAME: RIGHT ANGLE RECEPTACLE ASSEMBLY WITH GUIDES MULTI-BEAM XL

PRODUCT SPEC: 108-1973

APPLICATION SPEC: 114-13038

SIZE: A1

CAGE CODE: 6450360

DRAWING NO: 100779

SCALE: 4:1

SHEET: 1 OF 6

REV: H5

CUSTOMER DRAWING

REVISIONS				
P. LTM	DESCRIPTION	DATE	DWN	APVD
-	SEE SHEET 1	-	-	-

PART NUMBER	ROWS	POWER				SIGNAL				POWER	
		P4	P3	5	4	3	2	1	P2	P1	
6450360-1	D C B A	RA	RA	H	H	H	H	H	RA	RA	
				G	G	G	G	G			
				F	F	F	F	F			
		E	E	E	E	E	E				
2P + 20S + 2P											

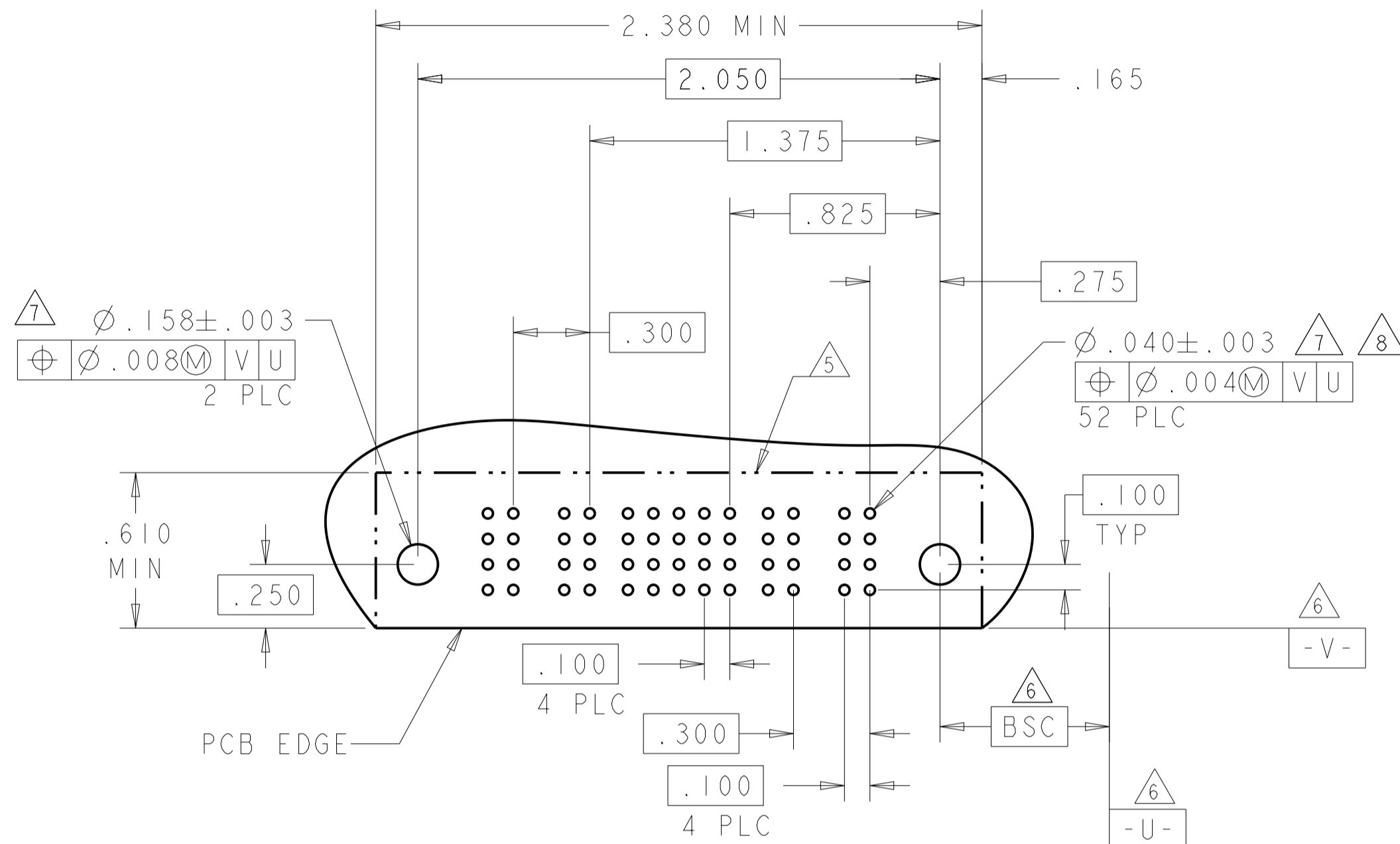

PART NUMBER	ROWS	POWER			SIGNAL				POWER					
		P9	P8	P7	4	3	2	1	P6	P5	P4	P3	P2	P1
6450360-9	D C B A	RM	RM	RM	H	H	H	H	RM	RM	RM	RM	RM	RM
					G	G	G	G						
					F	F	F	F						
					E	E	E	E						
6P + 16S + 3ACP														

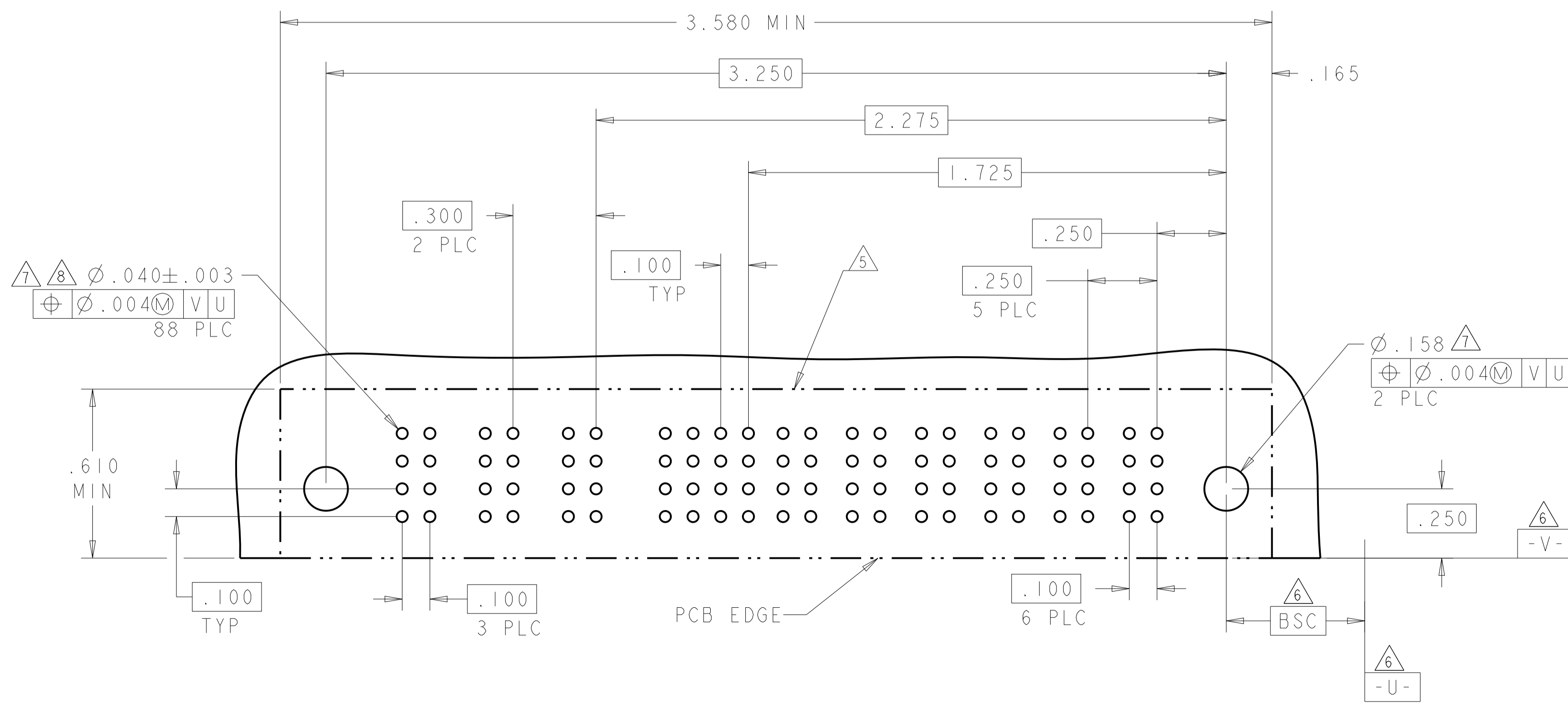

PART NUMBER	ROWS	POWER		SIGNAL		POWER	
		P4	P3	2	1	P2	P1
6450360-8	D C B A	RM	RM	H	H	RM	RM
				G	G		
				F	F		
		E	E				
2P + 8S + 2P							

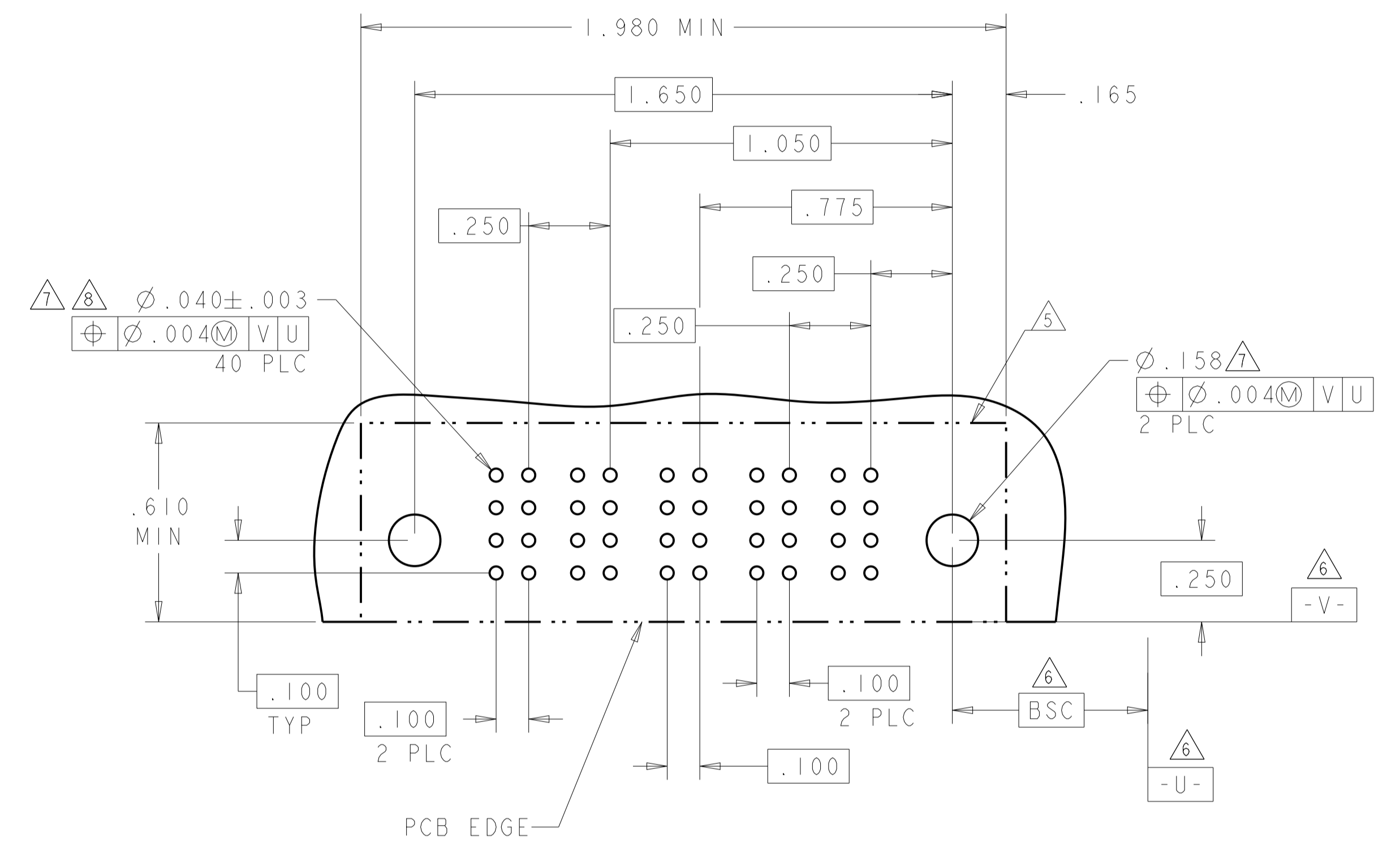

CODE	TAIL LENGTH	DESCRIPTION
RB	.090	MFBL
RM	.135	STD
RA	.135	MFBL

POWER CONTACT

CODE	TAIL LENGTH	ROW
L	.090	D
K	.090	C
J	.090	B
I	.090	A
H	.135	D
G	.135	C
F	.135	B
E	.135	A

SIGNAL CONTACT

THIS DRAWING IS A CONTROLLED DOCUMENT.		OWN R. GRZYBOWSKI	OBAPROS	STE TE Connectivity
DIMENSIONS: INCHES		CHK M. PERCZERKE	OBAPROS	
TOLERANCES UNLESS OTHERWISE SPECIFIED:		NAME RIGHT ANGLE RECEPTACLE ASSEMBLY WITH GUIDES MULTI-BEAM XL		
0 PLC ± 1 PLC ±.01 2 PLC ±.01 3 PLC ±.005 4 PLC ±.002 ANGLES ±.020				
MATERIAL	FINISH	PRODUCT SPEC 108-1973	APPLICATION SPEC 114-13038	SIZE A1
		WEIGHT -	CAGE CODE -	DRAWING NO 6450360
CUSTOMER DRAWING		SCALE 4:1		SHEET 2 OF 6
				REV H5

REVISIONS				
P. LTR.	DESCRIPTION	DATE	OWN	APVD
-	SEE SHEET 1	-	-	-

PART NUMBER	ROWS	POWER							SIGNAL		POWER		
		P10	P9	P8	P7	P6	P5	P4	2	1	P3	P2	P1
I-6450360-0	D C B A	RM	RM	RM	RM	RM	RM	RM	H	H	RM	RM	RM
									G	G			
									F	F			
									E	E			

PART NUMBER	ROWS	POWER				SIGNAL					POWER		
		P6	P5	P4	P3	6	5	4	3	2	1	P2	P1
I-6450360-1	D C B A	RM	RM	RM	RM	H	H	H	H	H	H	RM	RM
						G	G	G	G	G	G		
						F	F	F	F	F	F		
						E	E	E	E	E	E		

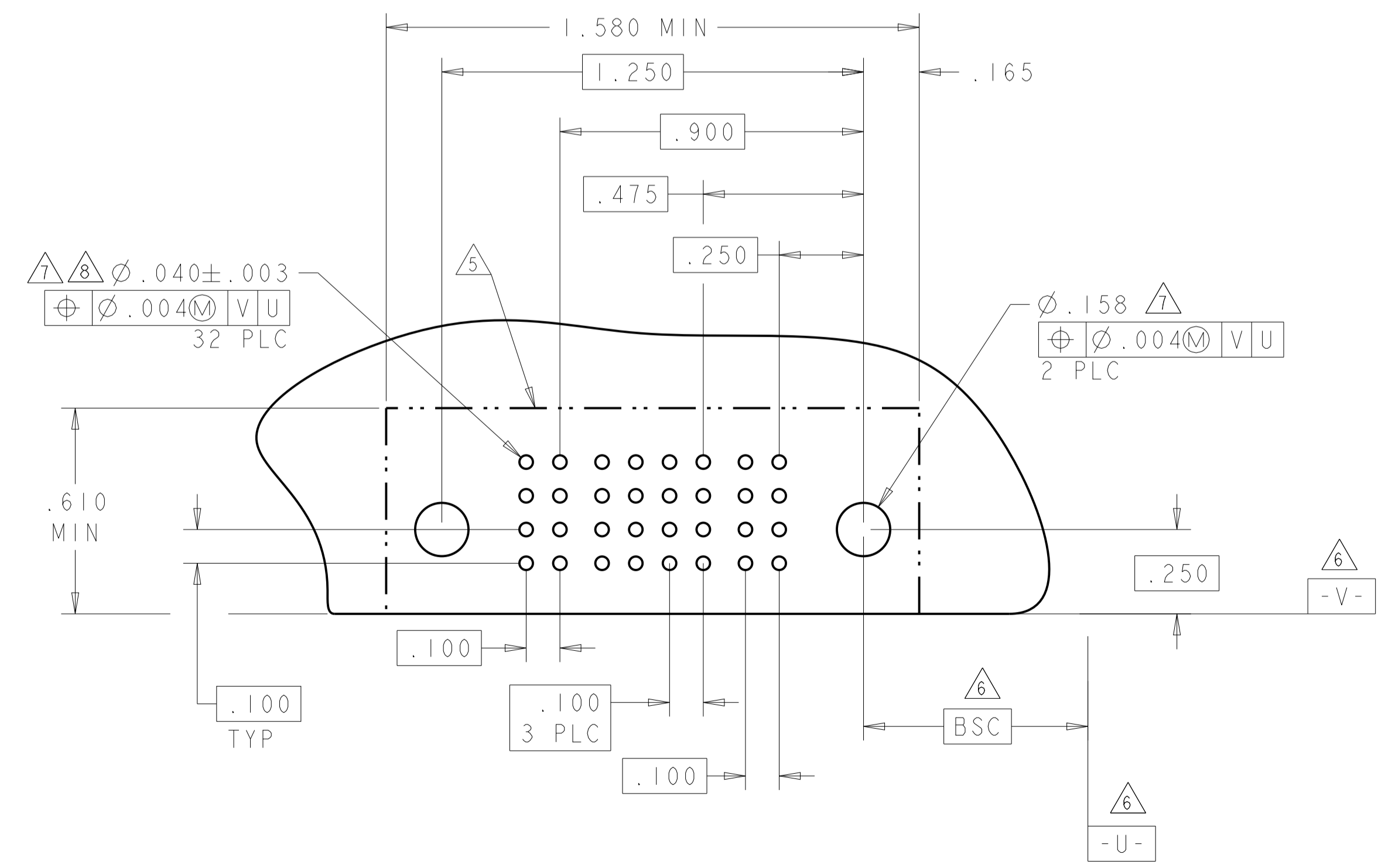
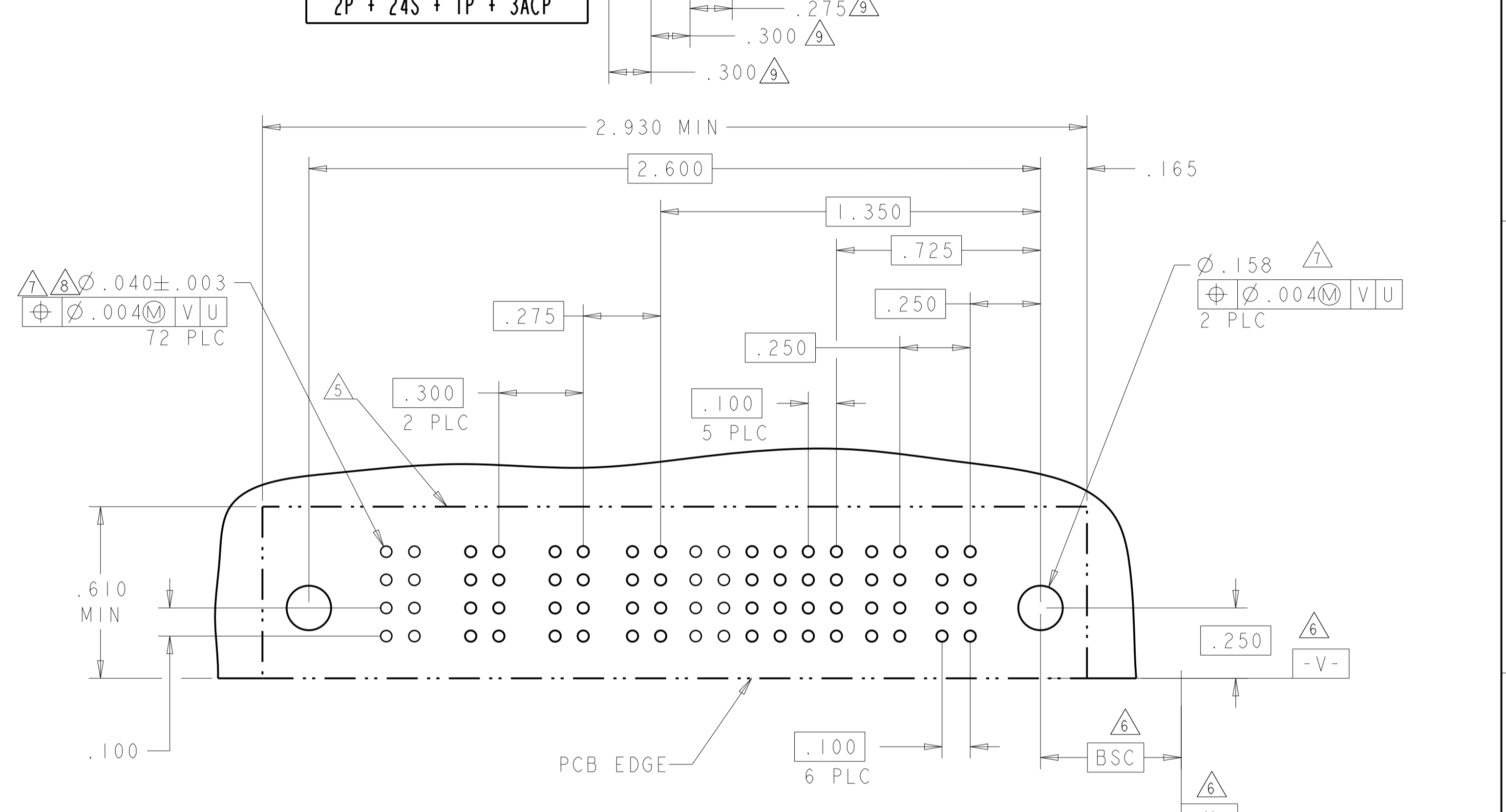
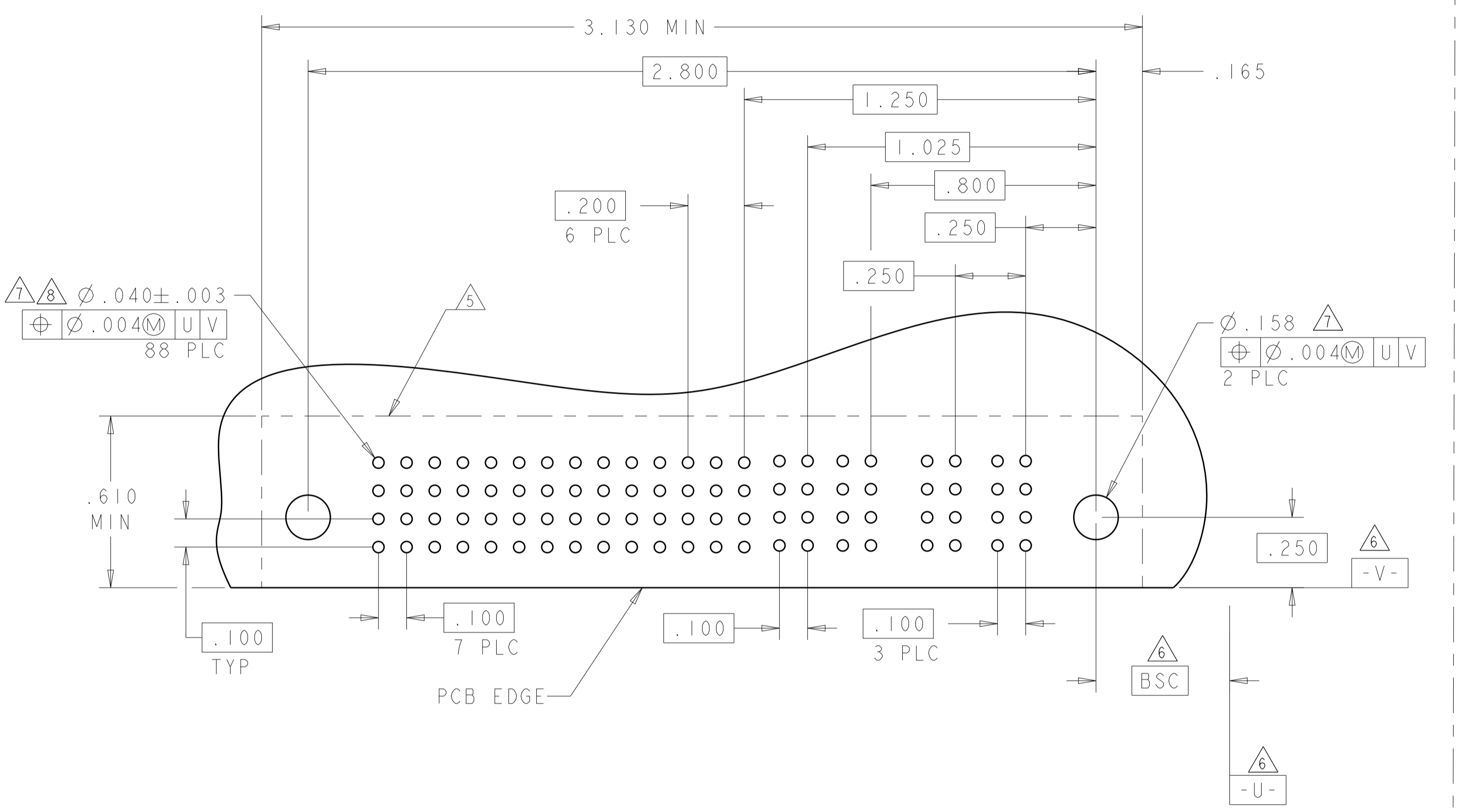

PART NUMBER	ROWS	POWER		SIGNAL				POWER
		P2	4	3	2	1	P1	
I-6450360-2	D C B A	RA		H	H	H	H	RA
				G	G	G	G	
				F	F	F	F	
				E	E	E	E	

THIS DRAWING IS A CONTROLLED DOCUMENT.		OWN: R. GRZYBOWSKI / 08APROS	 TE Connectivity
DIMENSIONS: INCHES		CHK: M. PERCHERKE / 08APROS	
TOLERANCES UNLESS OTHERWISE SPECIFIED:		APVD: M. PERCHERKE	NAME: RIGHT ANGLE RECEPTACLE ASSEMBLY WITH GUIDES MULTI-BEAM XL
0 PLC ±.01		PRODUCT SPEC: 108-1973	SIZE: A1
1 PLC ±.01		APPLICATION SPEC: 114-13038	CAGE CODE: 6450360
2 PLC ±.005		WEIGHT: -	RESTRICTED TO: -
3 PLC ±.002		FINISH: -	SCALE: 4:1
4 PLC ±.002		CUSTOMER DRAWING	SHEET 3 OF 6
ANGLES: -			REV: H5

REVISIONS				
P.	LTN.	DESCRIPTION	DATE	APVD.
-	-	SEE SHEET 1	-	-

PART NUMBER	ROWS	POWER		SIGNAL												POWER		
		P4	P3	12	11	10	9	8	7	6	5	4	3	2	1	P2	P1	
1-6450360-3	D	RM	RM	H	H	H	H	H	H	H	H	H	H	H	H	RM	RM	
	C			G	G	G	G	G	G	G	G	G	G	G	G			
	B			F	F	F	F	F	F	F	F	F	F	F	F			F
	A			E	E	E	E	E	E	E	E	E	E	E	E			E

2P + 48S + 2P

PART NUMBER	ROWS	POWER		SIGNAL				POWER	
		P4	P3	4	3	2	1	P2	P1
1-6450360-4	D	RM	RM	H	H	H	H	RM	RM
	C			G	G	G	G		
	B			F	F	F	F		
	A			E	E	E	E		

2P + 16S + 2P

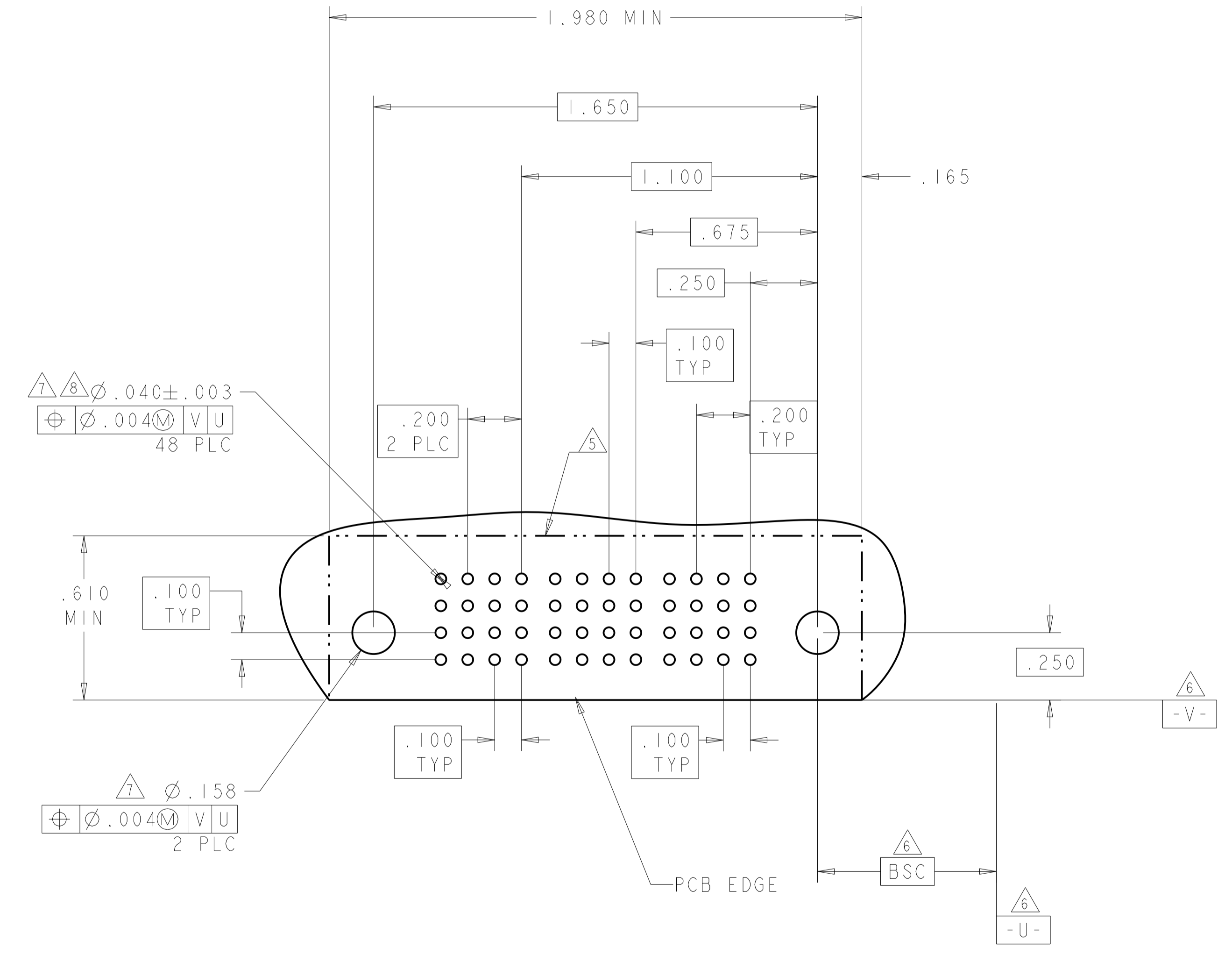
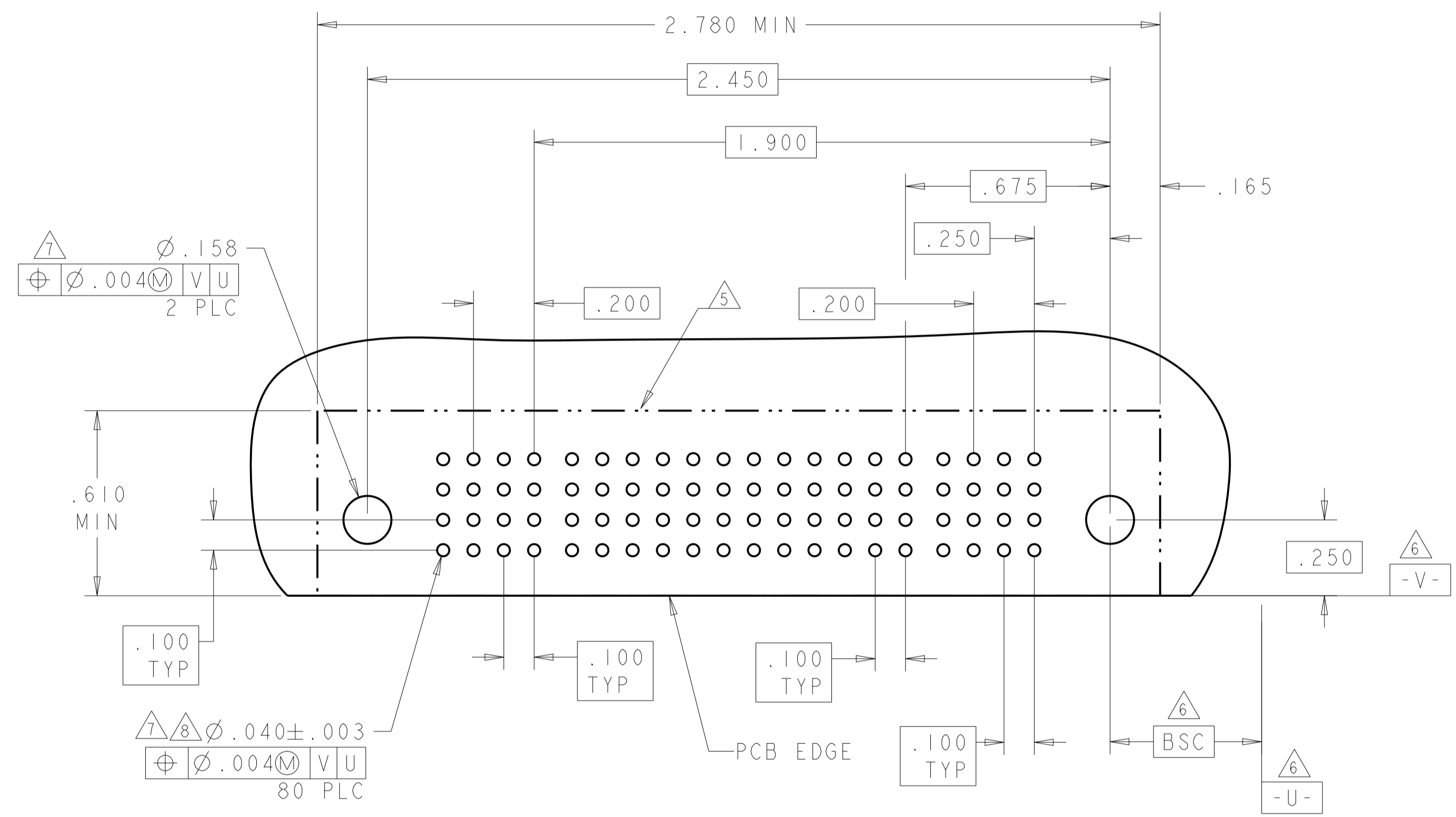

THIS DRAWING IS A CONTROLLED DOCUMENT.

DIMENSIONS: INCHES	TOLERANCES UNLESS OTHERWISE SPECIFIED:	0 PLC ±.01	1 PLC ±.01	2 PLC ±.01	3 PLC ±.005	4 PLC ±.002	ANGLES ±.020	FINISH
--------------------	--	------------	------------	------------	-------------	-------------	--------------	--------

OWN: R. GRZYBOWSKI	08APROS	NAME: RIGHT ANGLE RECEPTACLE ASSEMBLY WITH GUIDES MULTI-BEAM XL
CHK: M. PERCHERKE	08APROS	PRODUCT SPEC: 108-1973
APVD: M. PERCHERKE	-	APPLICATION SPEC: 114-13038
SIZE: A	CAGE CODE: 6450360	RESTRICTED TO: -
CUSTOMER DRAWING		SCALE: 4:1 SHEET 4 OF 6 REV: H5

4805 (3/13)

REVISIONS				
P.	LTN.	DESCRIPTION	DATE	APP'D.
-	-	SEE SHEET 1	-	-

PART NUMBER	ROWS	POWER		SIGNAL			POWER	
		P4	P3	3	2	1	P2	P1
6450360-7	D C B A	RA	RA	H	H	H	RA	RA
				G	G	G		
				F	F	F		
				E	E	E		
2P + 12S + 2P								

PART NUMBER	ROWS	POWER		SIGNAL										POWER						
		P6	P5	11	10	9	8	7	6	5	4	3	2	1	P5	P4	P3	P2	P1	
1-6450360-5	D C B A	RM	RM	H	H	H	H	H	H	H	H	H	H	H	RM	RM	RM	RM	RM	
				G	G	G														
				F	F	F	F	F	F	F	F	F	F	F						F
				E	E	E	E	E	E	E	E	E	E	E						E
5P + 44S + 1P																				

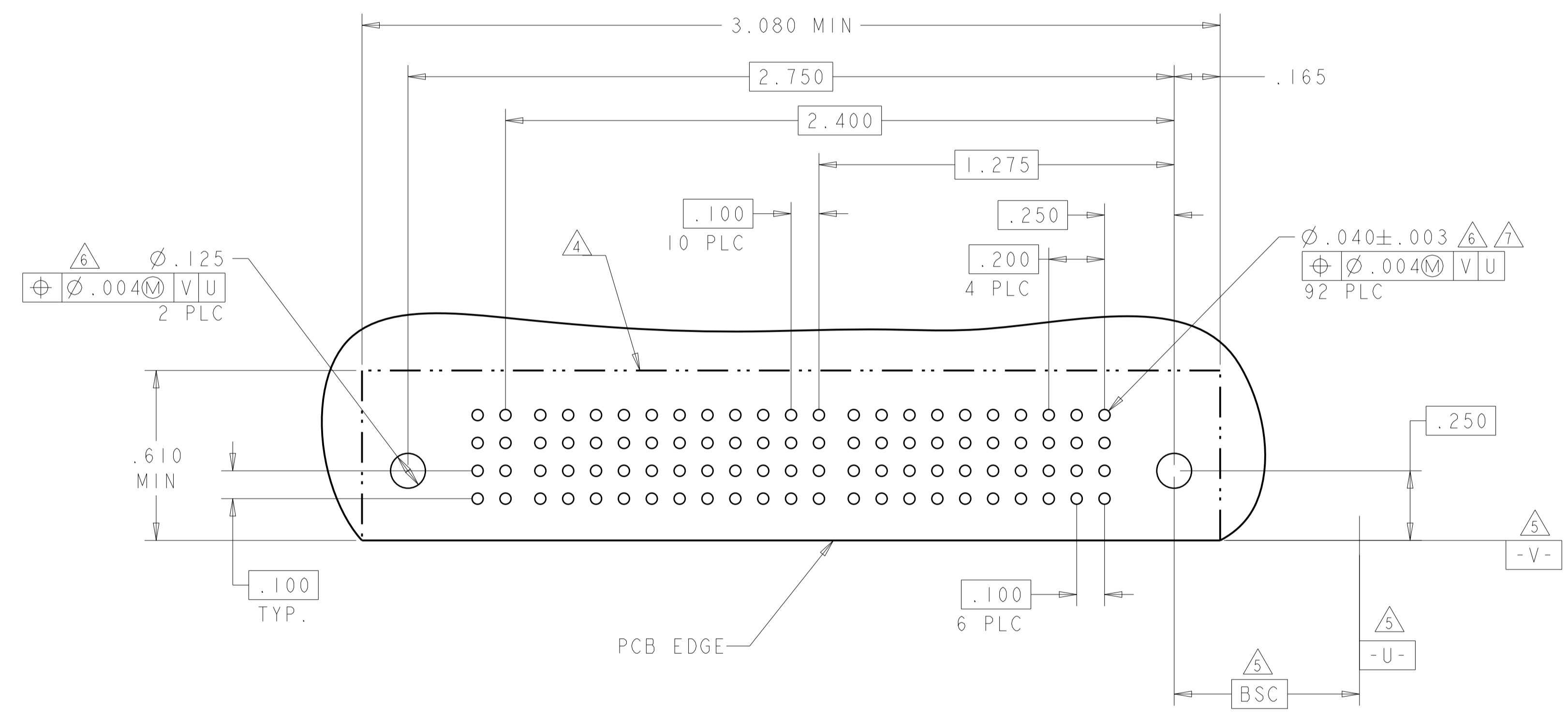
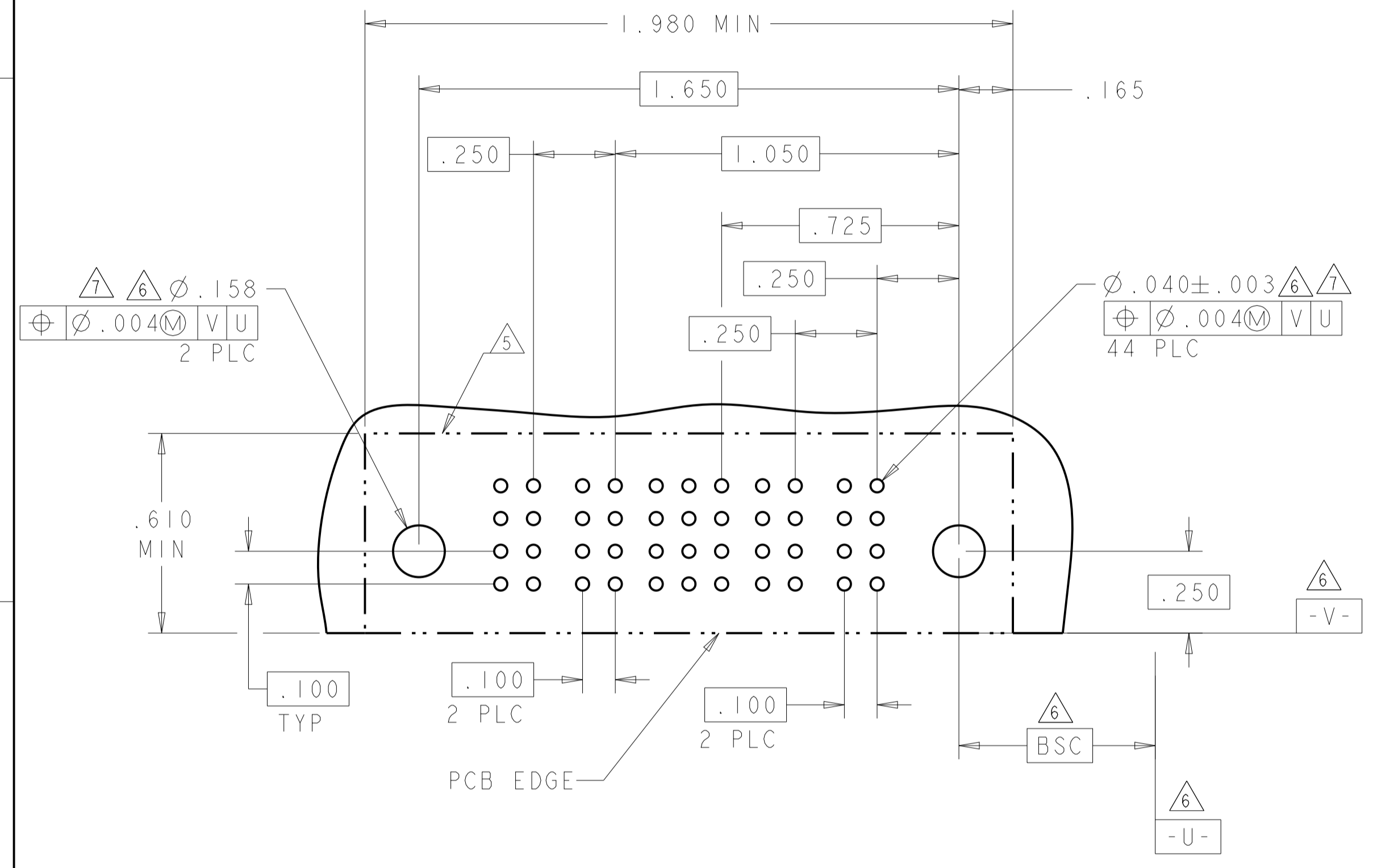

THIS DRAWING IS A CONTROLLED DOCUMENT.		OWN: R. GRZYBOWSKI / 08APROS	 TE Connectivity
DIMENSIONS: INCHES		CHK: M. PERCHERKE / 08APROS	
TOLERANCES UNLESS OTHERWISE SPECIFIED:		APVD: M. PERCHERKE	NAME: RIGHT ANGLE RECEPTACLE ASSEMBLY WITH GUIDES MULTI-BEAM XL
0 PLC ±.01	1 PLC ±.01	PRODUCT SPEC: 108-1973	SIZE: A1
2 PLC ±.01	3 PLC ±.005	APPLICATION SPEC: 114-13038	CAGE CODE: 6450360
4 PLC ±.0020	ANGLES ±.0020	WEIGHT: -	SCALE: 4:1
MATERIAL: -	FINISH: -	CUSTOMER DRAWING	SHEET 5 OF 6
REV: H5			DATE: -

REVISIONS				
REV	LTN	DESCRIPTION	DATE	APP'D
-	-	SEE SHEET 1	-	-

PART NUMBER	ROWS		SIGNAL													POWER				
			P5	12	11	10	9	8	7	6	5	4	3	2	1	P4	P3	P2	P1	
1-6450360-6	D	RM	H		H	H	H	H		H	H			H	RM	RM	RM	RM		
	C		G		G	G	G	G		G	G	G	G							
	B		F		F	F	F	F		F	F	F	F							
	A		E		E	E	E	E	E	E	E	E	E							

4P + 48S + 1P

BLANK SIGNAL PINS ARE UNLOADED

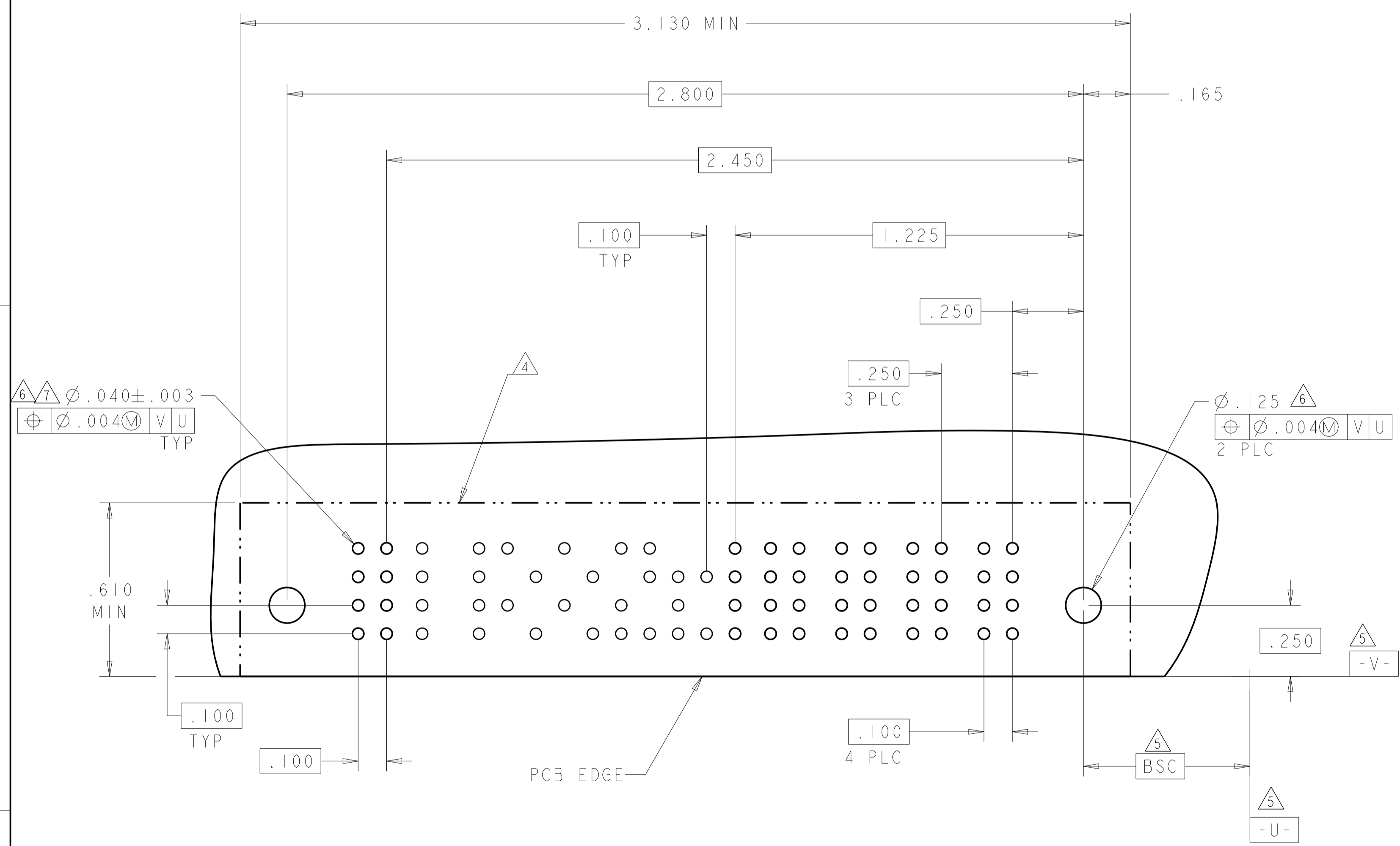

THIS DRAWING IS A CONTROLLED DOCUMENT.		OWN R. GRZYBOWSKI	08APROS	 TE Connectivity	NAME RIGHT ANGLE RECEPTACLE ASSEMBLY WITH GUIDES MULTI-BEAM XL	RESTRICTED TO
DIMENSIONS: INCHES		CHK M. PERCHERKE	08APROS			
TOLERANCES UNLESS OTHERWISE SPECIFIED: 0 PLC ± 1 PLC ±.01 2 PLC ±.005 3 PLC ±.005 4 PLC ±.0020 ANGLES ±.2°		APVD M. PERCHERKE		PRODUCT SPEC 108-1973	SIZE 114-13038	SCALE 4:1 SHEET 6 OF 6 REV H5
MATERIAL -	FINISH -	WEIGHT -		APPLICATION SPEC 114-13038	CAGE CODE DRAWING NO. A100779C=6450360	
		CUSTOMER DRAWING				

Компания «Океан Электроники» предлагает заключение долгосрочных отношений при поставках импортных электронных компонентов на взаимовыгодных условиях!

Наши преимущества:

- Поставка оригинальных импортных электронных компонентов напрямую с производств Америки, Европы и Азии, а так же с крупнейших складов мира;
- Широкая линейка поставок активных и пассивных импортных электронных компонентов (более 30 млн. наименований);
- Поставка сложных, дефицитных, либо снятых с производства позиций;
- Оперативные сроки поставки под заказ (от 5 рабочих дней);
- Экспресс доставка в любую точку России;
- Помощь Конструкторского Отдела и консультации квалифицированных инженеров;
- Техническая поддержка проекта, помощь в подборе аналогов, поставка прототипов;
- Поставка электронных компонентов под контролем ВП;
- Система менеджмента качества сертифицирована по Международному стандарту ISO 9001;
- При необходимости вся продукция военного и аэрокосмического назначения проходит испытания и сертификацию в лаборатории (по согласованию с заказчиком);
- Поставка специализированных компонентов военного и аэрокосмического уровня качества (Xilinx, Altera, Analog Devices, Intersil, Interpoint, Microsemi, Actel, Aeroflex, Peregrine, VPT, Syfer, Eurofarad, Texas Instruments, MS Kennedy, Miteq, Cobham, E2V, MA-COM, Hittite, Mini-Circuits, General Dynamics и др.);

Компания «Океан Электроники» является официальным дистрибьютором и эксклюзивным представителем в России одного из крупнейших производителей разъемов военного и аэрокосмического назначения «JONHON», а так же официальным дистрибьютором и эксклюзивным представителем в России производителя высокотехнологичных и надежных решений для передачи СВЧ сигналов «FORSTAR».



JONHON

«JONHON» (основан в 1970 г.)

Разъемы специального, военного и аэрокосмического назначения:

(Применяются в военной, авиационной, аэрокосмической, морской, железнодорожной, горно- и нефтедобывающей отраслях промышленности)

«FORSTAR» (основан в 1998 г.)

ВЧ соединители, коаксиальные кабели,
кабельные сборки и микроволновые компоненты:

(Применяются в телекоммуникациях гражданского и специального назначения, в средствах связи, РЛС, а так же военной, авиационной и аэрокосмической отраслях промышленности).



Телефон: 8 (812) 309-75-97 (многоканальный)

Факс: 8 (812) 320-03-32

Электронная почта: ocean@oceanchips.ru

Web: <http://oceanchips.ru/>

Адрес: 198099, г. Санкт-Петербург, ул. Калинина, д. 2, корп. 4, лит. А