

Nano Energy™

Ultra Low Iq Buck Converter For Low Power Applications

BD70522GUL

General Description

The BD70522GUL is a Buck Converter featuring 180nA quiescent current and supports output current up to 500mA. The Constant ON-Time (COT) control with ULP (Ultra Low Power) mode provides superior transient response and extends battery life by providing excellent light load efficiency below 10µA load range. The output voltage can be selected from 9 pre-set voltages by VSEL pins. When the input voltage gets close to the output voltage, the IC enters 100%ON mode where the switching operation stops.

Key Specifications

| | |
|--------------------------------|----------------|
| ■ Input Voltage Range: | 2.5V to 5.5V |
| ■ Output Voltage Range: | 1.2V to 3.3V |
| ■ Maximum Output Current: | 500mA |
| ■ Operating Quiescent Current: | 180nA (Typ) |
| ■ Standby Current: | 50nA (Typ) |
| ■ Operating Temperature Range: | -40°C to +85°C |

Package

VCSP50L1C

W(Typ) x D(Typ) x H(Max)

1.76mm x 1.56mm x 0.57mm

Features

- Nano Energy™
- 180nA (Typ) Quiescent Current
- Up to 90% Efficiency at 10µA Output Current
- Up to 500mA Output Current
- 9 Selectable Output Voltages
(1.2V, 1.5V, 1.8V, 2.0V, 2.5V, 2.8V, 3.0V, 3.2V, 3.3V)
- Power Good Output
- 100%ON Mode for Low Input Voltage
- Discharge Function on VOUT

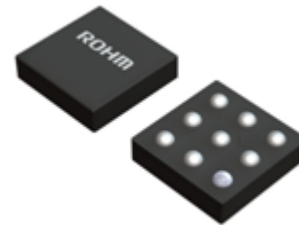

Applications

- Smoke Detector
- Thermostat
- Portable Devices
- Wearable Devices
- Low-Iq Applications without Standby Switcher
- Energy Harvesting

Typical Application Circuit

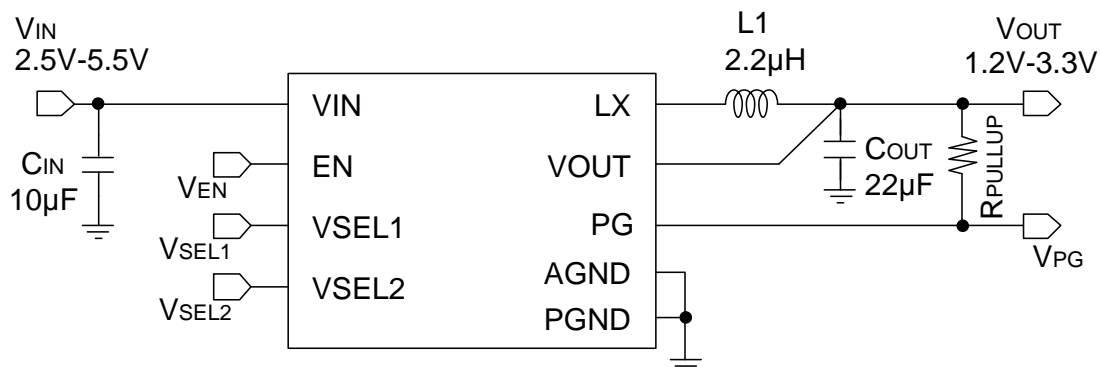

Figure 1. Typical Application Circuit

「Nano Energy™」 is a trademark of Rohm Co., Ltd.

○Product structure : Silicon monolithic integrated circuit ○This product has no designed protection against radioactive rays

www.rohm.com

© 2017 ROHM Co., Ltd. All rights reserved.
TSZ22111 • 14 • 001

Contents

| | |
|---|----|
| General Description | 1 |
| Features..... | 1 |
| Applications | 1 |
| Key Specifications | 1 |
| Package..... | 1 |
| Typical Application Circuit..... | 1 |
| Contents | 2 |
| Pin Configuration | 3 |
| Pin Descriptions..... | 3 |
| Block Diagram | 3 |
| Absolute Maximum Ratings | 4 |
| Thermal Resistance..... | 4 |
| Recommended Operating Conditions..... | 4 |
| Electrical Characteristics..... | 4 |
| Electrical Characteristics - continued..... | 5 |
| Detailed Descriptions..... | 6 |
| Typical Performance Curves..... | 8 |
| Figure 7-10. Efficiency vs Output Current | 8 |
| Figure 11-14. Output Voltage vs Output Current | 9 |
| Figure 15-18. Switching Frequency vs Output Current | 10 |
| Figure 19-22. Output Ripple Voltage vs Output Current | 11 |
| Figure 23-26. Load Transient Response | 12 |
| Figure 27-30. Line Transient Response | 13 |
| Figure 31-34. Line Transient Response | 14 |
| Figure 35-36. Startup..... | 15 |
| Figure 37-38. Shutdown | 15 |
| Figure 39-42. Input Voltage Ramp Up/Down..... | 16 |
| Timing Chart | 17 |
| Application Examples | 18 |
| I/O Equivalence Circuits..... | 19 |
| Operational Notes..... | 20 |
| Ordering Information..... | 22 |
| Marking Diagram | 22 |
| Physical Dimension and Packing Information | 23 |
| Revision History..... | 24 |

Pin Configuration

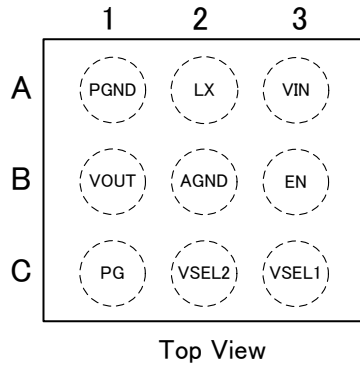

Figure 2. Pin Configuration

Pin Descriptions

| Pin No. | Pin Name | Description |
|---------|----------|---|
| A1 | PGND | Power Ground Pin |
| A2 | LX | Switching Pin. Connect an inductor to this pin. |
| A3 | VIN | Power Supply Input Pin. Connect an input capacitor close to this pin. |
| B1 | VOUT | Feedback Pin for internal feedback divider network and regulation loop. This pin is also used for VOUT discharge while EN pin is set to low. |
| B2 | AGND | Analog Ground Pin |
| B3 | EN | Enable Pin. This pin must be terminated. High : Enable Low : Shutdown Do not pull up EN terminal higher than VIN voltage. |
| C1 | PG | Power Good Open Drain Output Pin. PG remains low while the VOUT pin voltage is lower than the threshold voltage. If not used, this pin can be left open. Do not pull up PG terminal to a voltage which is higher than VIN voltage. |
| C2 | VSEL2 | Output Voltage Selection Pins. These pins have three states : High = VIN (Connect these pins to VIN directly without pull up resistors) Low = GND (Connect these pins to GND directly without pull down resistors) OPEN = No Connection (PCB:C<50pF, R>1Mohm) The setting of these pins cannot be changed while the IC is operating. |
| C3 | VSEL1 | |

Block Diagram

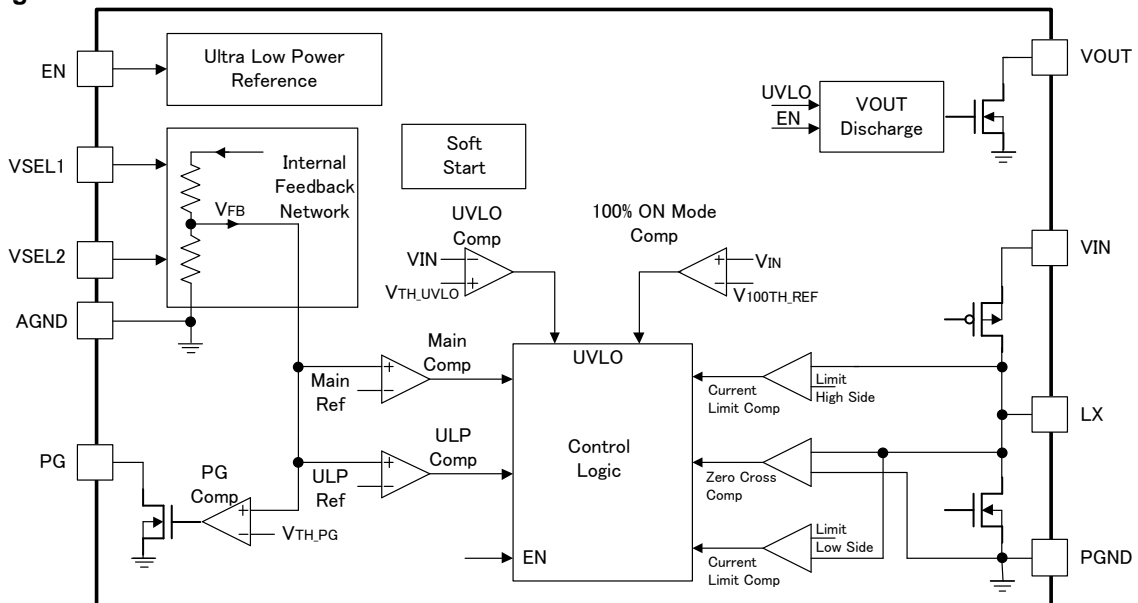

Figure 3. Block Diagram

Absolute Maximum Ratings (Ta=25°C)

| Parameter | Symbol | Rating | Unit |
|------------------------------|-------------------|-------------------------------|------|
| Supply Voltage | V _{IN} | -0.3 to +6 | V |
| LX Voltage | V _{LX} | -0.3 to V _{IN} +0.3V | V |
| EN Voltage | V _{EN} | -0.3 to V _{IN} +0.3V | V |
| PG Voltage | V _{PG} | -0.3 to V _{IN} +0.3V | V |
| VSEL1, 2 Voltage | V _{SEL} | -0.3 to V _{IN} +0.3V | V |
| PG Sink Current | I _{PG} | 10 | mA |
| Power Dissipation | P _d | 0.592 (Note 1) | W |
| Maximum Junction Temperature | T _{jmax} | 150 | °C |
| Storage Temperature Range | T _{stg} | - 55 to + 150 | °C |

Caution 1: Operating the IC over the absolute maximum ratings may damage the IC. The damage can either be a short circuit between pins or an open circuit between pins and the internal circuitry. Therefore, it is important to consider circuit protection measures, such as adding a fuse, in case the IC is operated over the absolute maximum ratings.

Caution 2: Should by any chance the maximum junction temperature rating be exceeded the rise in temperature of the chip may result in deterioration of the properties of the chip. In case of exceeding this absolute maximum rating, design a PCB boards with power dissipation taken into consideration by increasing board size and copper area so as not to exceed the maximum junction temperature rating.

(Note 1) The derating is 4.74 mW/°C while the device is operating above Ta ≥ 25°C (Mounted on 4-layer 50.0mm x 58.0mm x 1.6mm FR-4 board)

Thermal Resistance

| Parameter | Symbol | Thermal Resistance (Typ) | Unit |
|---------------------|-----------------|--------------------------|------|
| VCSP50L1C | | | |
| Junction to Ambient | θ _{JA} | 168.8 | °C/W |

| Layer Number of Measurement Board | Material | Board Size |
|-----------------------------------|----------|-------------------------|
| 4 Layers | FR-4 | 50.0mm x 58.0mm x 1.6mm |

Recommended Operating Conditions

| Parameter | Symbol | Min | Typ | Max | Unit |
|-----------------------------|------------------|-----|-----|-----|------|
| Supply Voltage (Note 2) | V _{IN} | 2.5 | 3.6 | 5.5 | V |
| Output Current | I _{OUT} | - | - | 500 | mA |
| Inductance (Note 3) | L | - | 2.2 | - | μH |
| Output Capacitance (Note 4) | C _{OUT} | 10 | 22 | 100 | μF |
| Operating Temperature | T _{opr} | -40 | +25 | +85 | °C |

(Note 2) Initial startup voltage is over 2.6V (Max)

(Note 3) The effective inductance should be kept in the specified range from 1.5μH to 3.5μH, including the variety of tolerance, temperature, current derating.

(Note 4) The effective capacitance should be kept this specified range including variety of tolerance, temperature, bias voltage derating.

Electrical Characteristics

(Unless otherwise specified V_{IN}=3.6V Ta=25°C)

| Parameter | Symbol | Min | Typ | Max | Unit | Conditions |
|------------------------------|----------------------|------|------|------|------|--|
| Circuit Current | | | | | | |
| Shutdown Current | I _{ST} | - | 50 | 1000 | nA | |
| Operating Quiescent Current | I _Q | - | 180 | 1000 | nA | No switching, V _{EN} = V _{IN} V _{SEL} =V _{IN} Include VSEL, EN pin current |
| Under Voltage Lockout | | | | | | |
| UVLO Detection Threshold | V _{UVLO} | 2.30 | 2.40 | 2.50 | V | V _{IN} falling |
| UVLO Release Threshold | V _{UVLORLS} | 2.40 | 2.50 | 2.60 | V | V _{IN} rising |

Electrical Characteristics - continued

(Unless otherwise specified $V_{IN}=3.6V$ $T_a=25^{\circ}C$)

| Parameter | Symbol | Min | Typ | Max | Unit | Conditions |
|---------------------------------------|---------------|--------------|------|--------------|----------|---|
| Control | | | | | | |
| EN High Level | V_{ENH} | 1.1 | - | - | V | |
| EN Low Level | V_{ENL} | - | - | 0.3 | V | |
| EN Input Current | I_{EN} | - | 0 | 1 | μA | |
| VSEL High Level | V_{SELH} | $V_{IN}-0.3$ | - | $V_{IN}+0.3$ | V | |
| VSEL Low Level | V_{SELL} | -0.3 | - | +0.3 | V | |
| VSEL Input Current | I_{VSEL} | - | 0 | 1 | μA | |
| Power Switch | | | | | | |
| High-side FET On-Resistance | R_{ONH} | - | 0.30 | 0.45 | Ω | $I_{LX} = 50mA$ |
| Low-side FET On-Resistance | R_{ONL} | - | 0.15 | 0.23 | Ω | $I_{LX} = -50mA$ |
| High-side FET Switch Current Limit 1 | $I_{LIMITH1}$ | 1225 | 1750 | 2275 | mA | Peak current of inductor |
| Low-side FET Switch Current Limit | I_{LIMITL} | 680 | 970 | 1260 | mA | Bottom current of inductor |
| High-side FET Switch Current Limit 2 | $I_{LIMITH2}$ | 680 | 970 | 1260 | mA | 100%ON Mode |
| V_{OUT} Discharge FET On-Resistance | R_{DISCH} | 50 | 100 | 200 | Ω | $I_{OUT} = -10mA$ |
| Power Good Output | | | | | | |
| Power Good Detection Threshold | V_{PGTH} | - | 95 | - | % | V_{OUT} rising |
| Power Good Hysteresis | V_{PGHYS} | - | -5 | - | % | |
| PG Low Level Output Voltage | V_{OLPG} | -0.3 | - | 0.3 | V | $I_{PG} = -1mA$ |
| PG Output Off Leak Current | I_{OFFPG} | - | 0 | 1 | μA | |
| 100% ON Mode Transition | | | | | | |
| 100% ON Mode Detection Threshold | V_{100THM} | 100 | 200 | 300 | mV | V_{IN} falling, $V_{IN} = V_{OUT} + V_{100THM}$ |
| 100% ON Mode Release Threshold | V_{100THP} | 150 | 250 | 350 | mV | V_{IN} rising, $V_{IN} = V_{OUT} + V_{100THP}$ |
| Output | | | | | | |
| Output Voltage Range | V_{OUTRG} | 1.2 | - | 3.3 | V | Refer to Table 1 |
| Output Voltage Accuracy 1 | V_{OACC1} | -2.0 | 0.0 | 2.0 | % | $I_{OUT} = 10mA$ |
| Output Voltage Accuracy 2 | V_{OACC2} | -2.5 | 0.0 | 2.5 | % | $I_{OUT} = 100mA$ |
| Startup Delay Time | t_{SDELAY} | 2.5 | 5.0 | 10.0 | ms | |
| Soft-Start Time | t_{SS} | 1.5 | 3.0 | 6.0 | ms | |

Table 1. Output Voltage Settings (Note 5)

| V_{SET} | VSEL1 | VSEL2 |
|-----------|----------|----------|
| 1.2V | GND | OPEN |
| 1.5V | OPEN | GND |
| 1.8V | GND | GND |
| 2.0V | V_{IN} | GND |
| 2.5V | OPEN | V_{IN} |
| 2.8V | V_{IN} | OPEN |
| 3.0V | OPEN | OPEN |
| 3.2V | GND | V_{IN} |
| 3.3V | V_{IN} | V_{IN} |

(Note 5) The output voltage is only determined by the states of VSEL1 and VSEL2 during the startup delay.
In order to reduce the current consumption, the output voltage cannot be changed by changing the states of VSEL1 and VSEL2 after the startup delay.

Detailed Descriptions

1. Constant ON-Time (COT) Control

The COT control topology supports CCM (Continuous Current Mode) for medium and high load conditions and DCM (Discontinuous Current Mode) for light load conditions.

The ON-Time is set in proportion to the output voltage (V_{OUT}), and in inverse proportion to power supply voltage (V_{IN}). Therefore, when in CCM, even if V_{IN} or V_{OUT} settings changes, the IC always operates in a constant frequency 1MHz (Typ) approximately.

If the load current decreases, the IC enters DCM seamlessly to maintain high efficiency down to very light loads, and the switching frequency varies approximately linearly with the load current.

2. 100%ON Mode

When V_{IN} gets close to V_{OUT} , the IC stops switching and starts 100% duty cycle operation. It connects the output to the input via the inductor and the internal high side MOSFET switch, when V_{IN} falls below the 100%ON Mode Enter Threshold (V_{100THM}). And when V_{IN} increases and exceeds the 100%ON Mode Release Threshold (V_{100THP}), the IC starts to switch again.

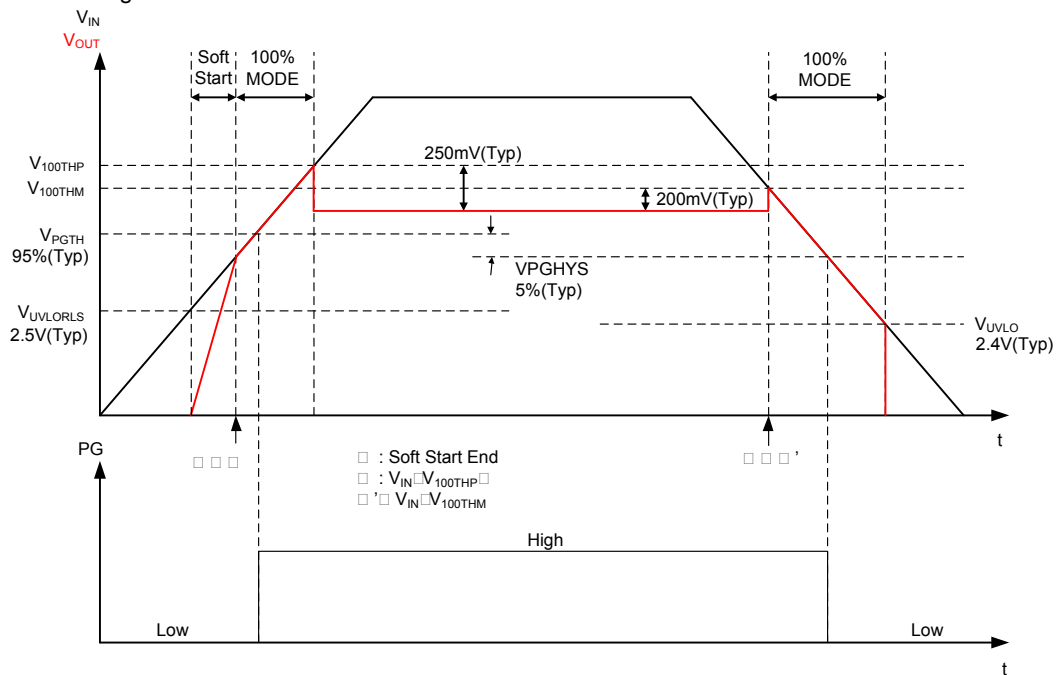

Figure 4. 100% ON Mode Transition

3. Ultra Low Power (ULP) Mode

2 comparators are used in this IC for monitoring V_{OUT} .

One is main comparator (Main Comp) and the other is ULP comparator (ULP Comp).

The transition from normal mode to ULP mode is judged pulse by pulse. While the Main Comp or the ULP Comp detects the decrease in V_{OUT} , the LX node switches for one pulse, then becomes high impedance.

If the high impedance state lasts over 8 μ s, the IC transits from normal mode to ULP mode.

In ULP mode, the Main Comp and the Power Good comparator (PG Comp) are disabled to reduce the current consumption. And when the ULP Comp detects the decrease in V_{OUT} , the Main Comp and the PG Comp are enabled, and the IC transits from ULP mode to normal mode.

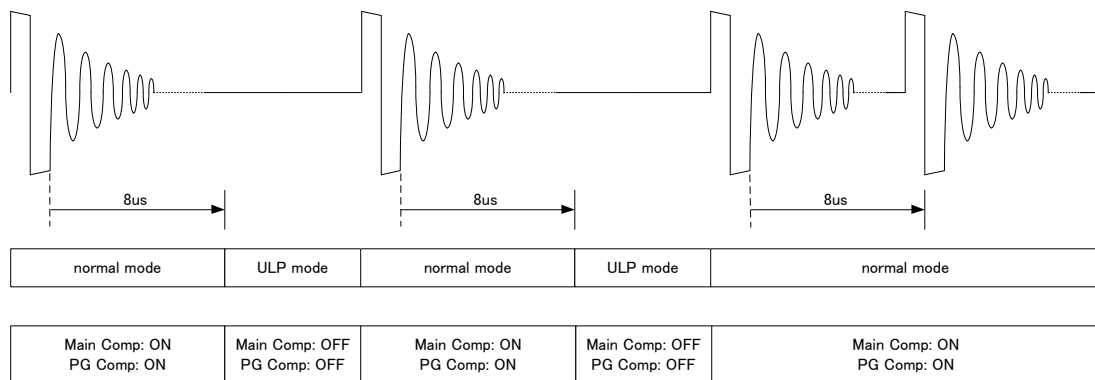

Figure 5. Transition between Normal Mode and ULP Mode

4. On-Time Extension

The On-Time is extended automatically to get the best transient response in the case of high duty cycle operation. If the Main Comp Output does not return to high level within Constant On-Time, the On-Time is extended until the Main Comp Output returns to high, and the maximum On-Time is limited to 16 μ s.

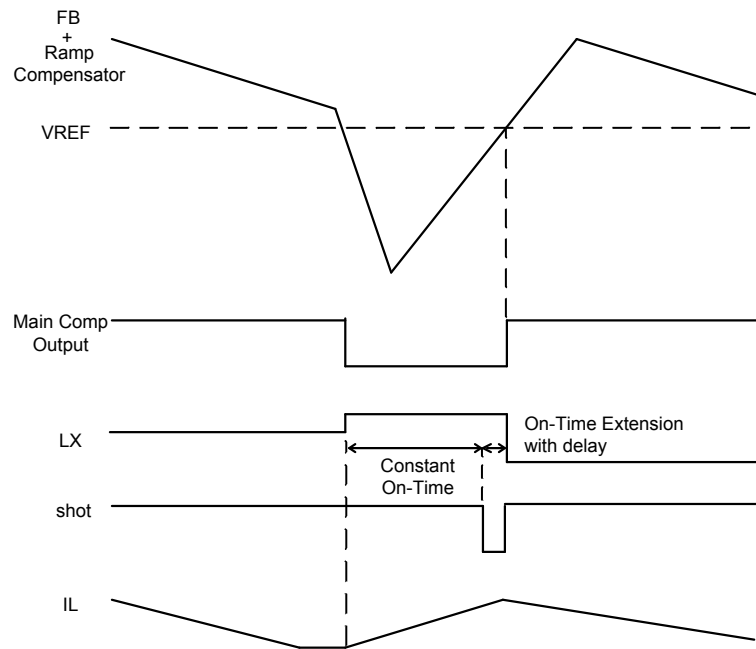

Figure 6. On-Time Extension

5. Discharge for VOUT

VOUT pin has a MOSFET for discharge which connects VOUT pin to GND when the IC is in standby state. (EN=Low or UVLO state or TSD state)

6. Power Good (PG) Output

PG pin is an open-drain output.

The PG Comp is active when EN pin is set to high and V_{IN} is above the threshold $V_{UVLORLS}$.

PG pin remains low when the V_{OUT} is lower than the PG detection threshold (V_{PGTH}) or during the soft-start time.

PG pin goes to high impedance when V_{OUT} exceeds V_{PGTH} .

And it is pulled to low level once V_{OUT} falls below the PG release threshold ($V_{PGTH}-V_{PGHYS}$).

7. Under Voltage Lock Out (UVLO)

UVLO function prevents the malfunction of the internal circuit when V_{IN} is too low.

If V_{IN} falls lower than 2.4V (Typ), the IC turns off.

In order to prevent from the misdetection of UVLO, it is necessary to set V_{IN} higher than 2.5V (Typ).

8. Over Current Limit (OCL)

BD70522GUL employs a bottom inductor current limit function which is achieved by using the low side MOSFET.

Turning on the high side MOSFET is prohibited while the inductor current is higher than the low side OCL (I_{LIMITL}).

This function keeps the inductor peak current lower than the sum of I_{LIMITL} and the inductor ripple current.

However, the low side OCL function does not work if the VOUT pin is directly shorted to GND. Thus, a high side OCL is implemented for such case.

The high side MOSFET turns off when the inductor current exceeds the high side OCL ($I_{LIMITH1}$). Furthermore, the peak current is limited to $I_{LIMITH1} \times 0.67$ under the On-Time extension state.

The inductor current is also limited to $I_{LIMITH2}$ under 100%ON mode, and the high side MOSFET is used to sense the current in this case.

9. Thermal Shutdown (TSD)

BD70522GUL stops the switching operation when the device temperature exceeds the TSD detection threshold

130°C (Typ) for protecting the IC from overheat. After the device temperature falls below the TSD release threshold

115°C (Typ), the IC starts the soft-start operation and recovers to the normal operation.

Typical Performance Curves
(Unless otherwise specified Ta=25°C)

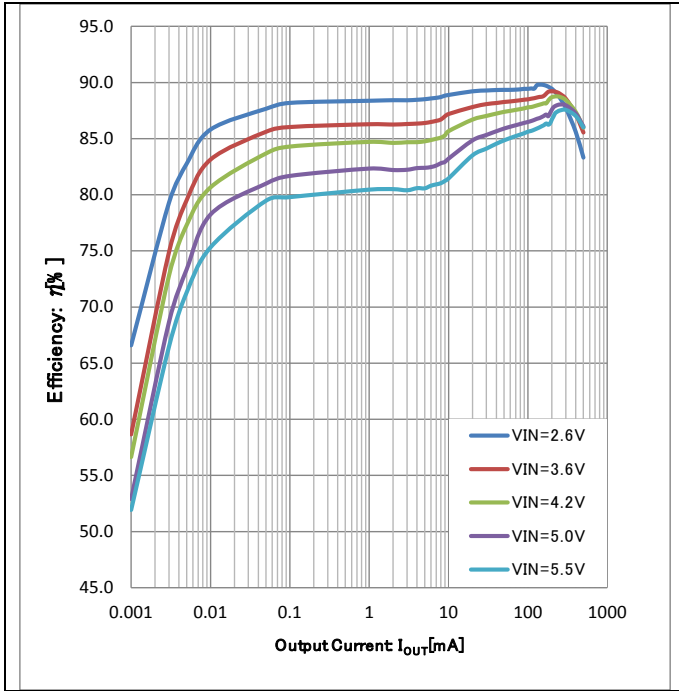

Figure 7. Efficiency vs Output Current
(V_{OUT}=1.2V)

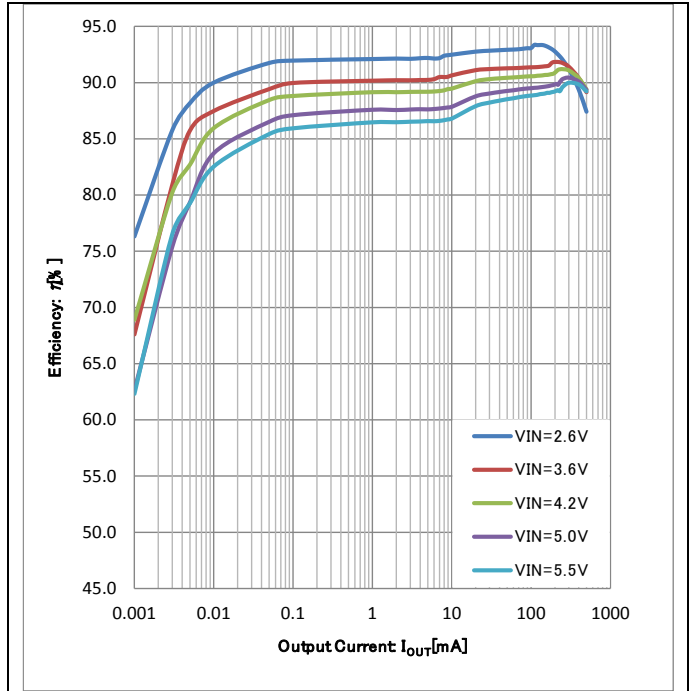

Figure 8. Efficiency vs Output Current
(V_{OUT}=1.8V)

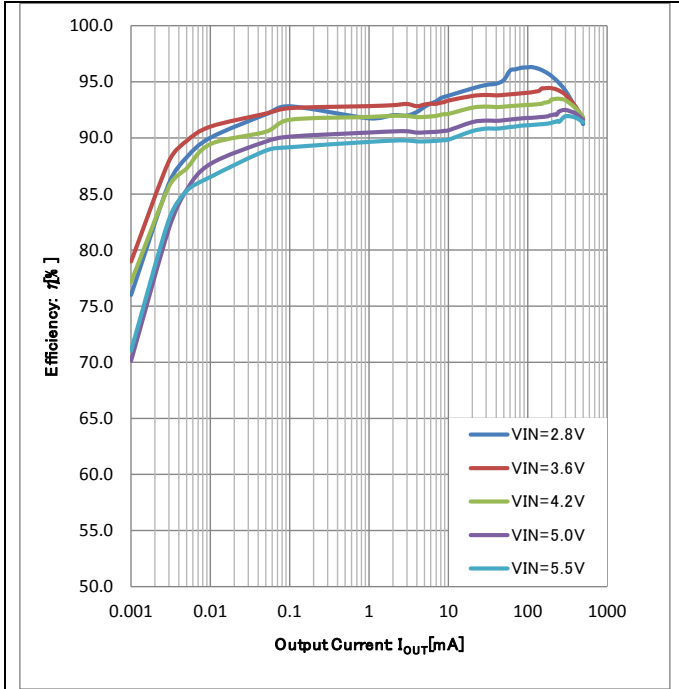

Figure 9. Efficiency vs Output Current
(V_{OUT}=2.5V)

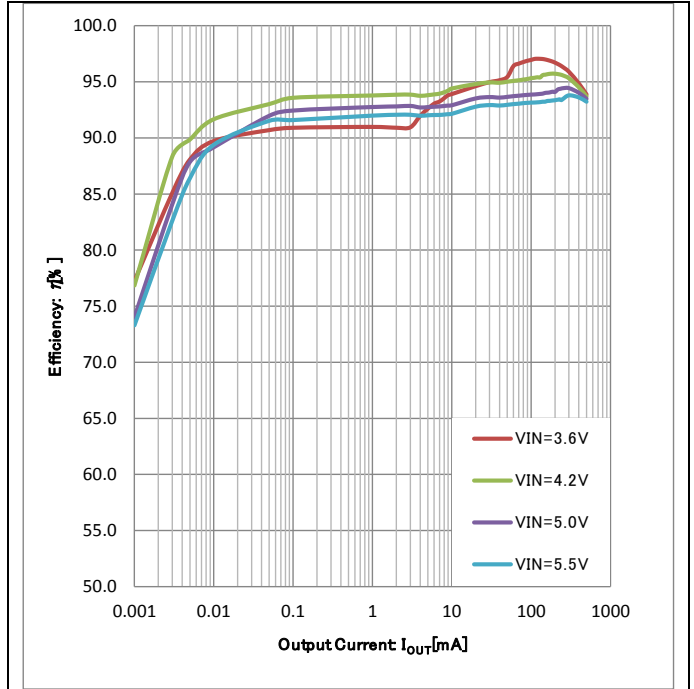

Figure 10. Efficiency vs Output Current
(V_{OUT}=3.3V)

Typical Performance Curves - continued
(Unless otherwise specified $T_a=25^\circ\text{C}$)

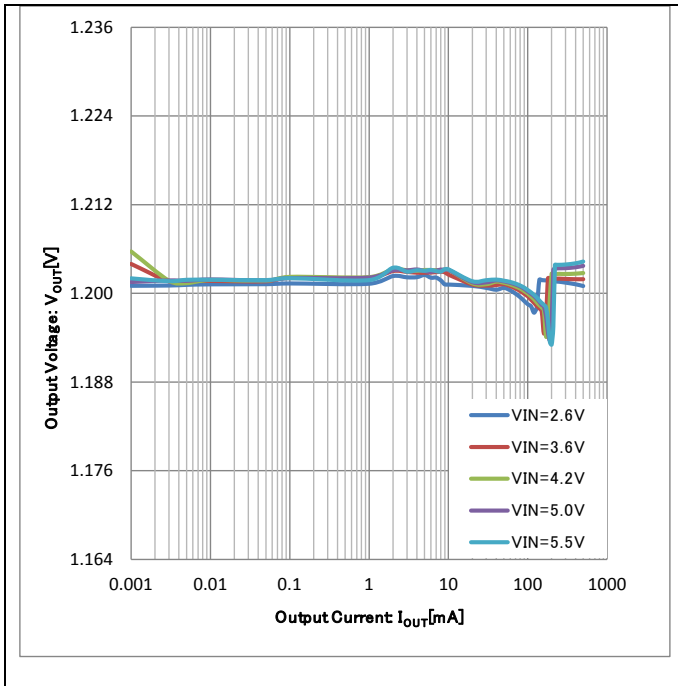

Figure 11. Output Voltage vs Output Current
(Load Regulation, $V_{OUT}=1.2\text{V}$)

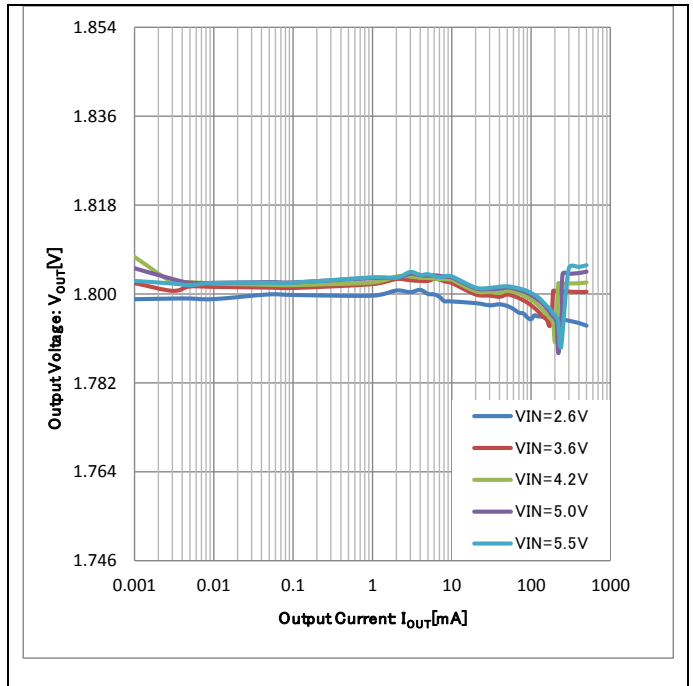

Figure 12. Output Voltage vs Output Current
(Load Regulation, $V_{OUT}=1.8\text{V}$)

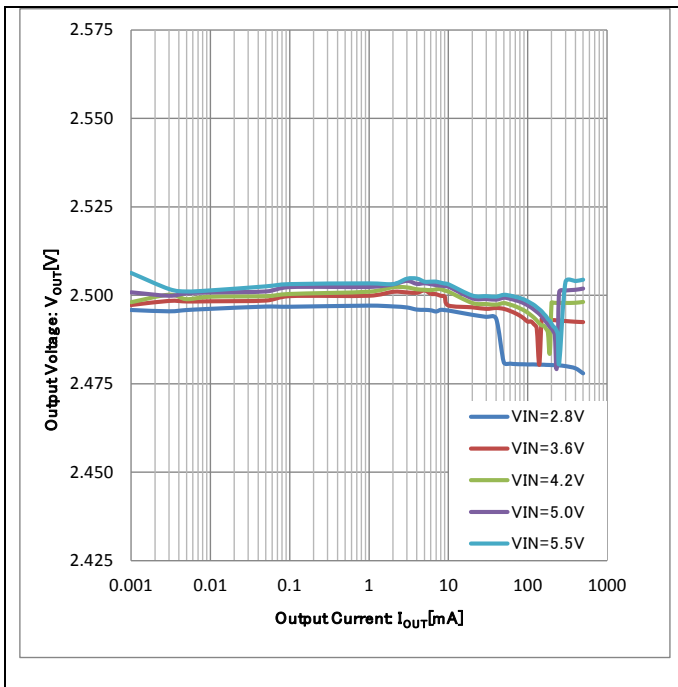

Figure 13. Output Voltage vs Output Current
(Load Regulation, $V_{OUT}=2.5\text{V}$)

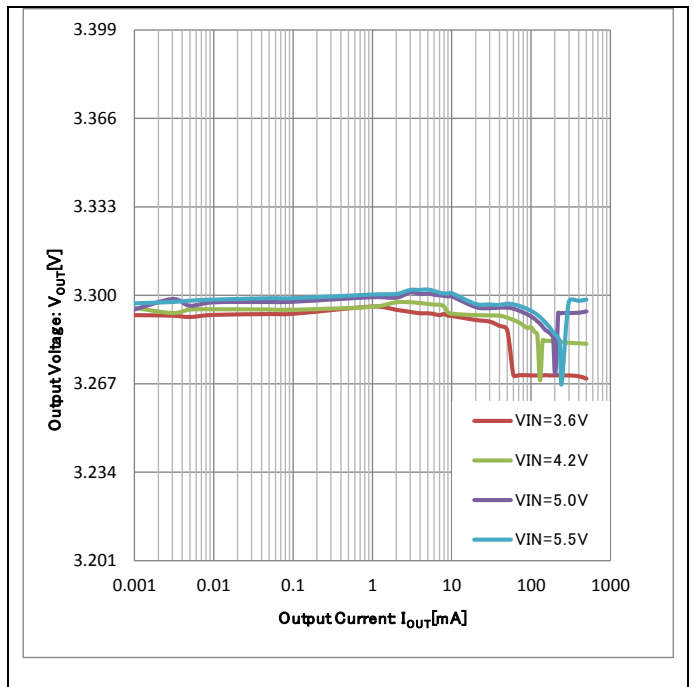

Figure 14. Output Voltage vs Output Current
(Load Regulation, $V_{OUT}=3.3\text{V}$)

Typical Performance Curves - continued
(Unless otherwise specified $T_a=25^\circ\text{C}$)

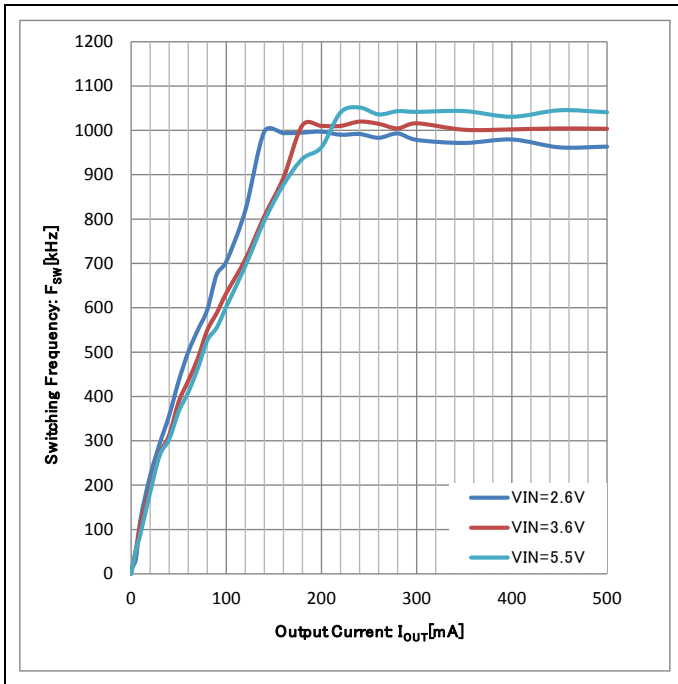

Figure 15. Switching Frequency vs Output Current ($V_{OUT}=1.2\text{V}$)

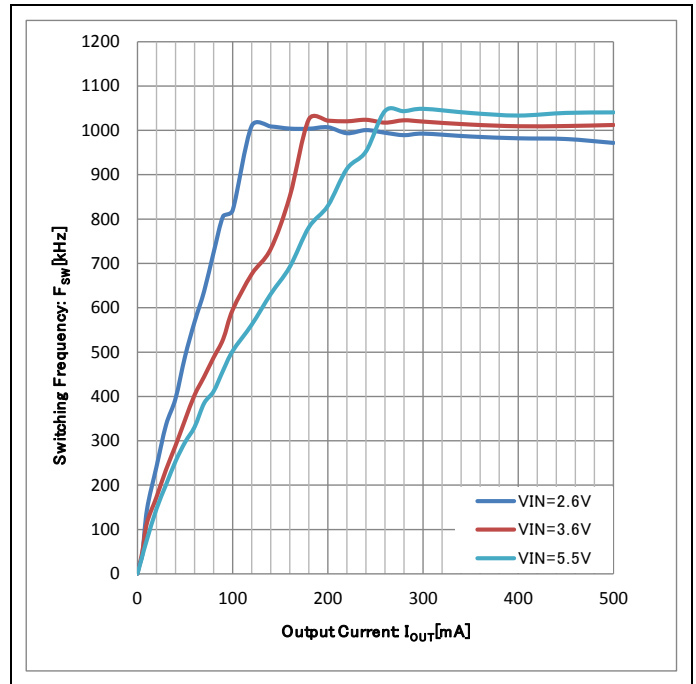

Figure 16. Switching Frequency vs Output Current ($V_{OUT}=1.8\text{V}$)

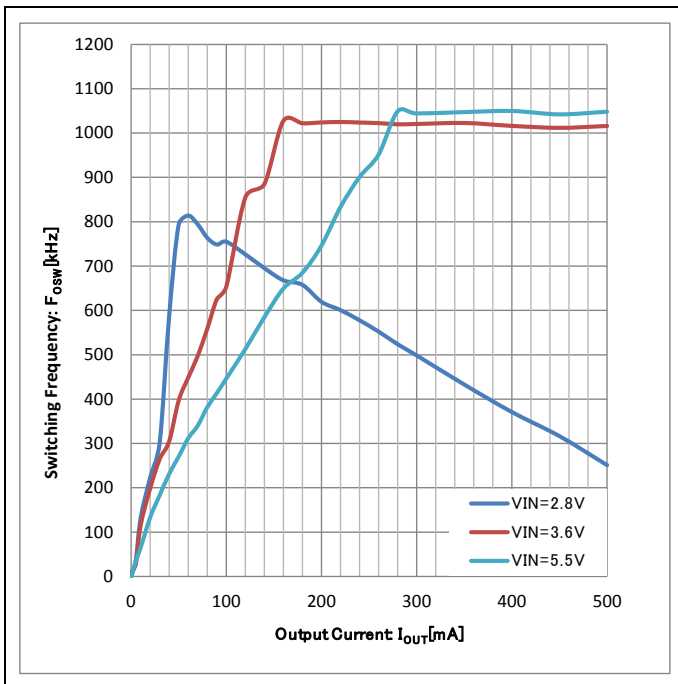

Figure 17. Switching Frequency vs Output Current ($V_{OUT}=2.5\text{V}$)

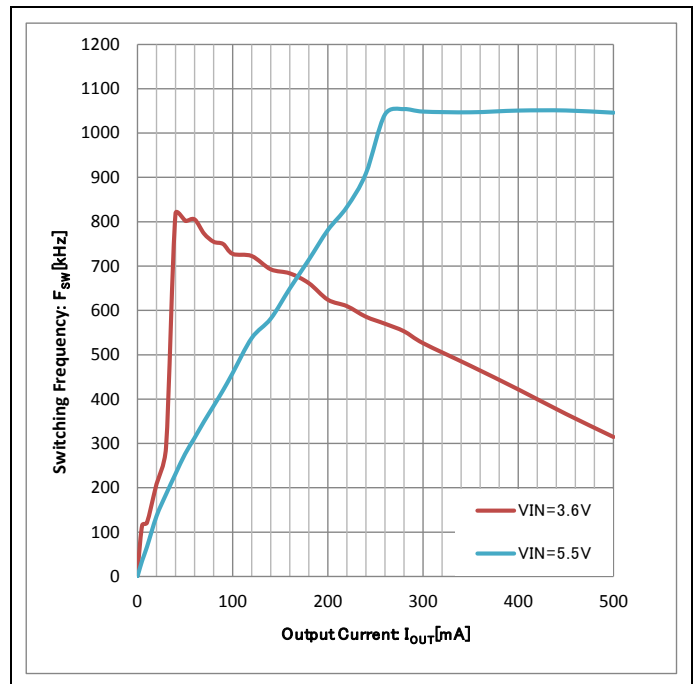

Figure 18. Switching Frequency vs Output Current ($V_{OUT}=3.3\text{V}$)

Typical Performance Curves - continued
(Unless otherwise specified $T_a=25^\circ\text{C}$)

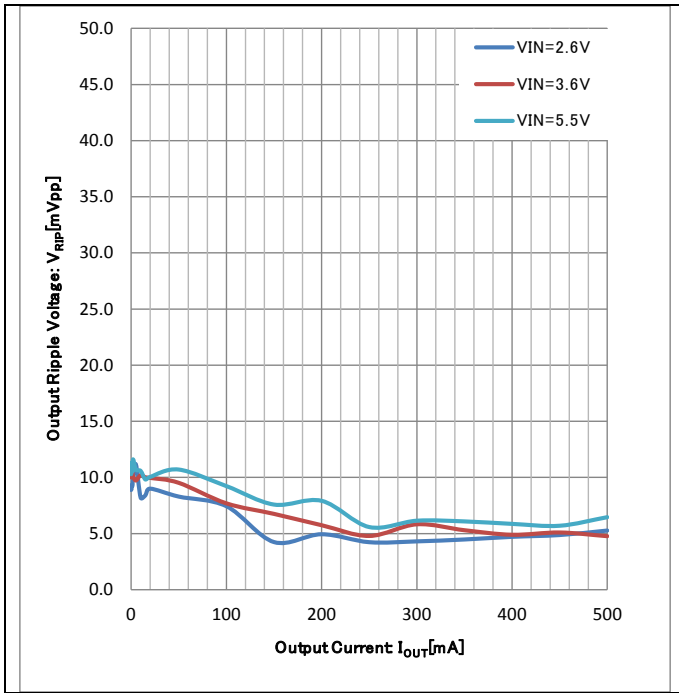

Figure 19. Output Ripple Voltage vs Output Current (Peak to Peak Output Ripple Voltage, $V_{OUT}=1.2\text{V}$)

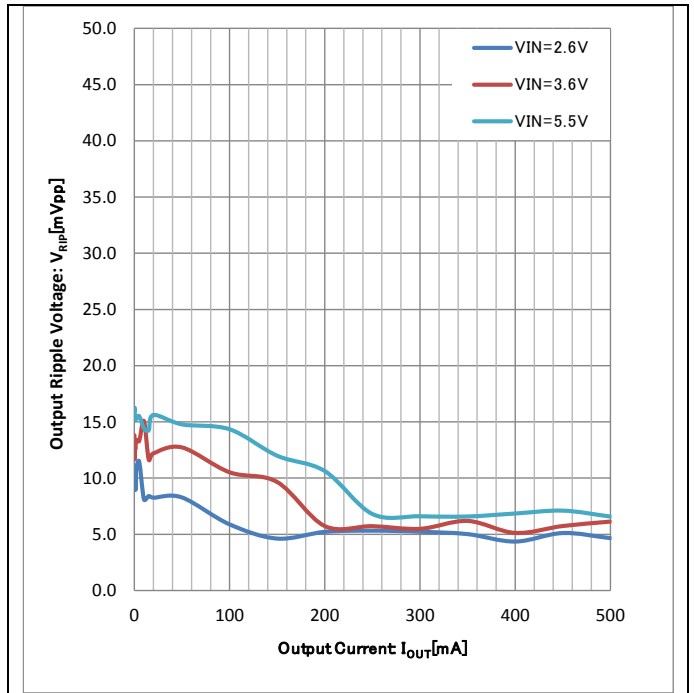

Figure 20. Output Ripple Voltage vs Output Current (Peak to Peak Output Ripple Voltage, $V_{OUT}=1.8\text{V}$)

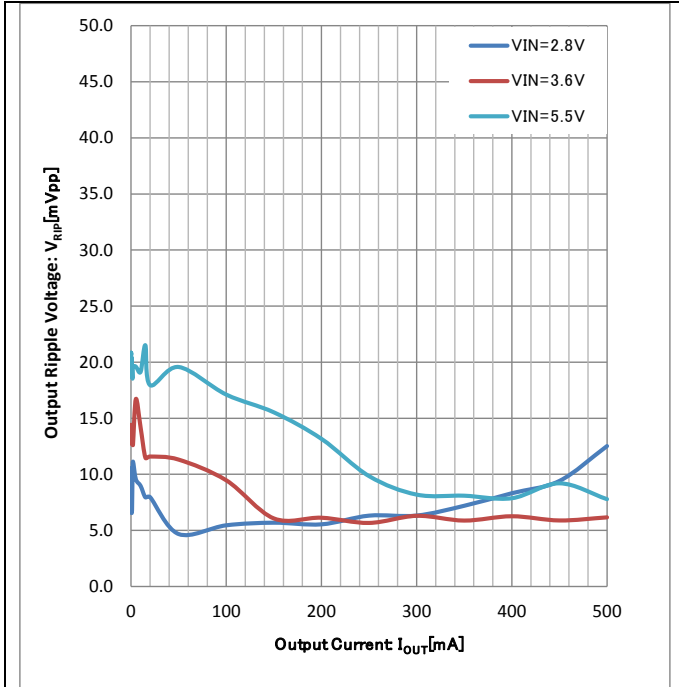

Figure 21. Output Ripple Voltage vs Output Current (Peak to Peak Output Ripple Voltage, $V_{OUT}=2.5\text{V}$)

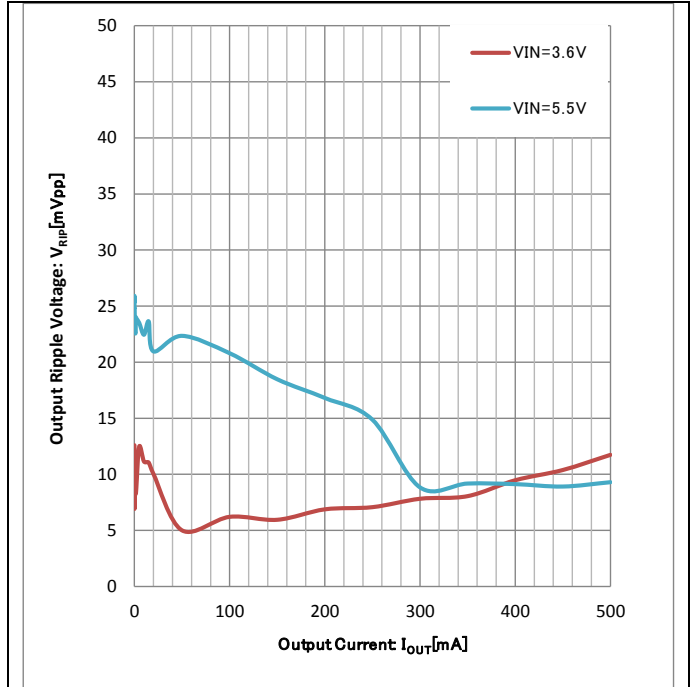

Figure 22. Output Ripple Voltage vs Output Current (Peak to Peak Output Ripple Voltage, $V_{OUT}=3.3\text{V}$)

Typical Performance Curves - continued
(Unless otherwise specified Ta=25°C)

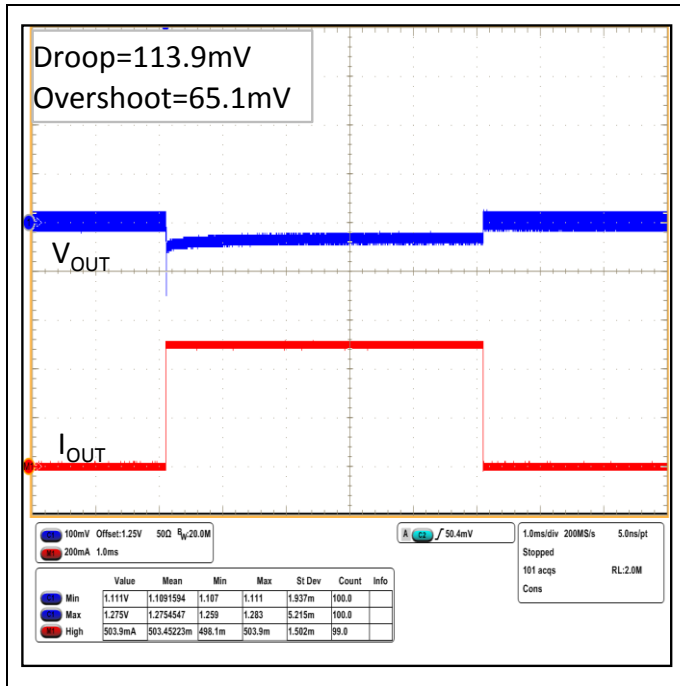

Figure 23. Load Transient Response
(VIN=3.6V, VOUT=1.2V, IOUT=1uA↔500mA, tr=tr=1μs)

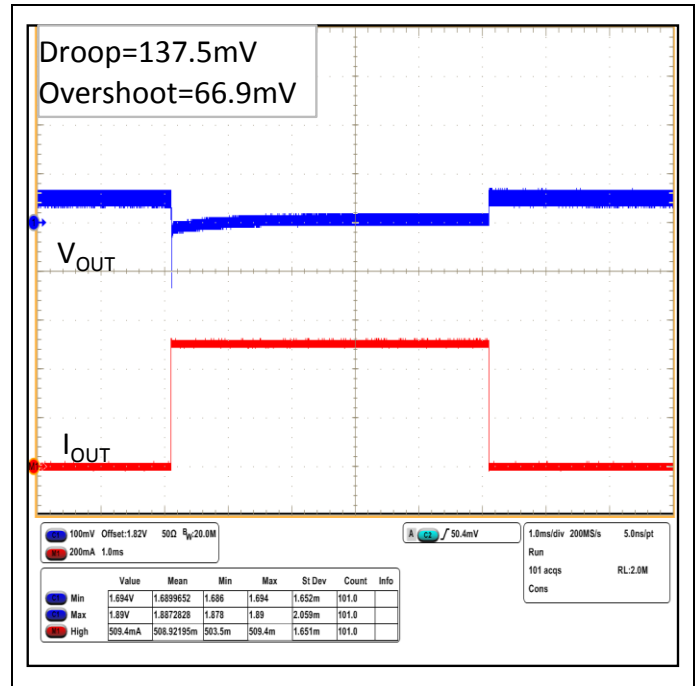

Figure 24. Load Transient Response
(VIN=3.6V, VOUT=1.8V, IOUT=1uA↔500mA, tr=tr=1μs)

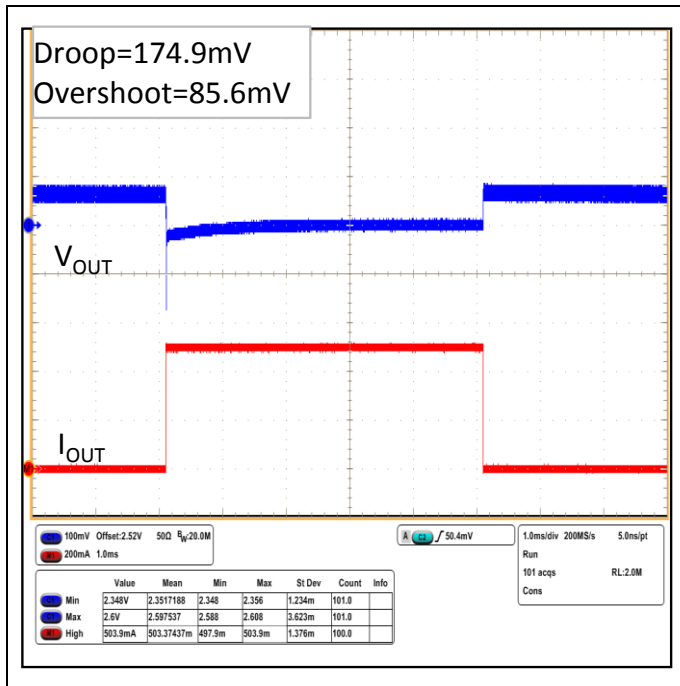

Figure 25. Load Transient Response
(VIN=3.6V, VOUT=2.5V, IOUT=1uA↔500mA, tr=tr=1μs)

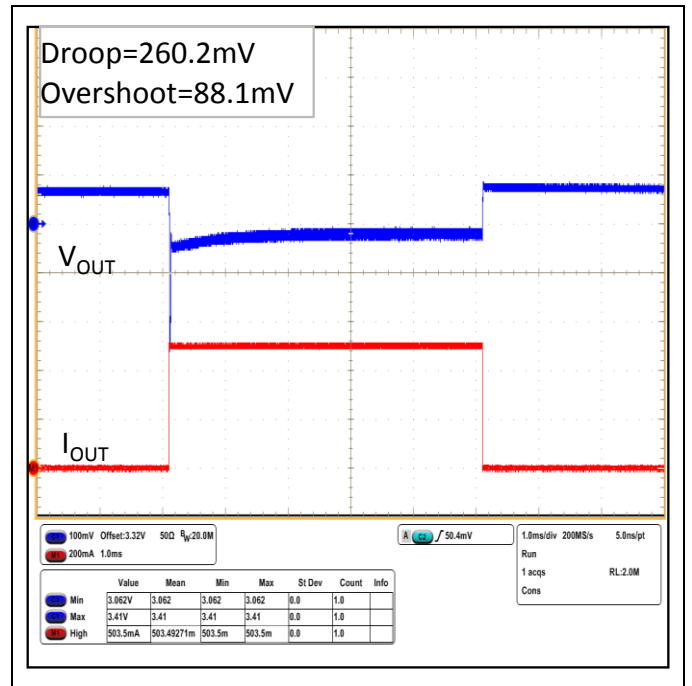

Figure 26. Load Transient Response
(VIN=3.6V, VOUT=3.3V, IOUT=1uA↔500mA, tr=tr=1μs)

Typical Performance Curves - continued
(Unless otherwise specified Ta=25°C)

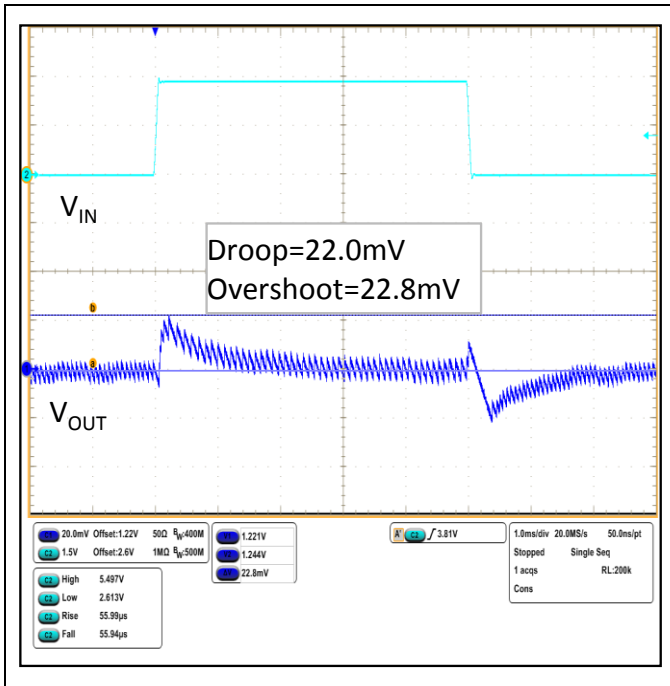

Figure 27. Line Transient Response
($V_{IN}=2.6V \leftrightarrow 5.5V$, $t_r=t_f=48\mu s$, $V_{OUT}=1.2V$, $I_{OUT}=1mA$)

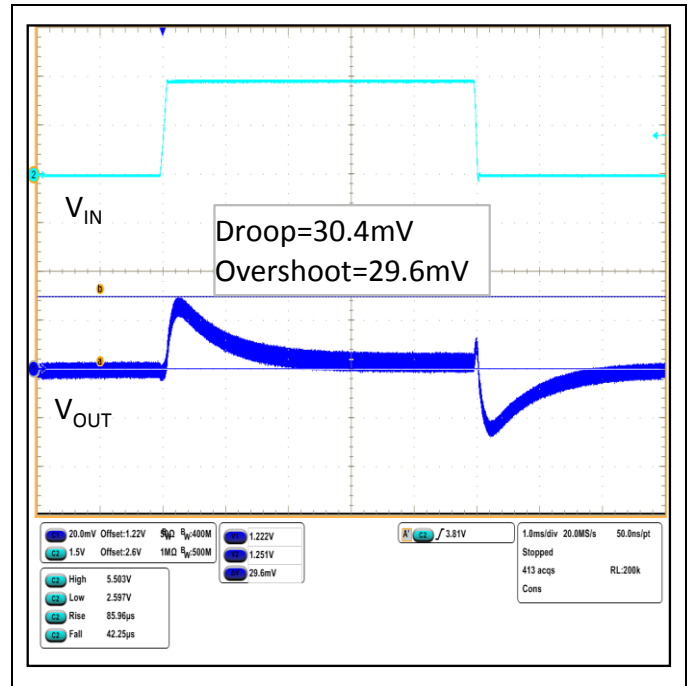

Figure 28. Line Transient Response
($V_{IN}=2.6V \leftrightarrow 5.5V$, $t_r=t_f=48\mu s$, $V_{OUT}=1.2V$, $I_{OUT}=500mA$)

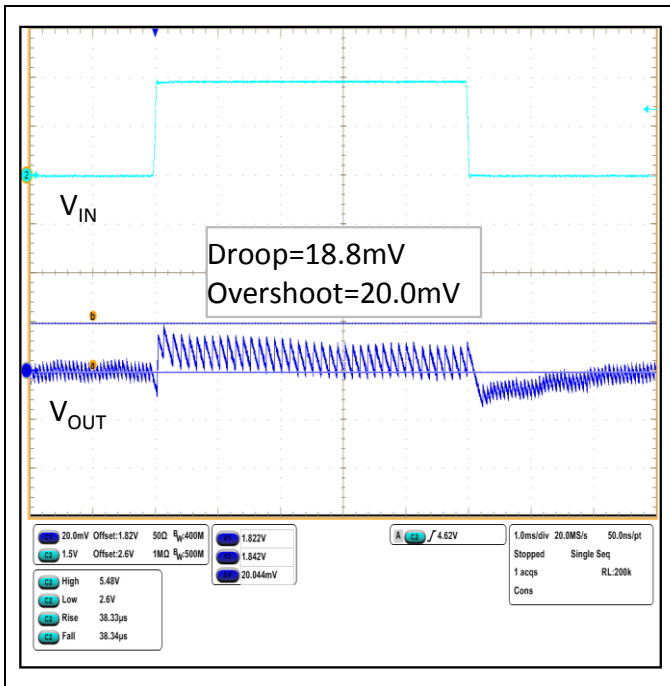

Figure 29. Line Transient Response
($V_{IN}=2.6V \leftrightarrow 5.5V$, $t_r=t_f=48\mu s$, $V_{OUT}=1.8V$, $I_{OUT}=1mA$)

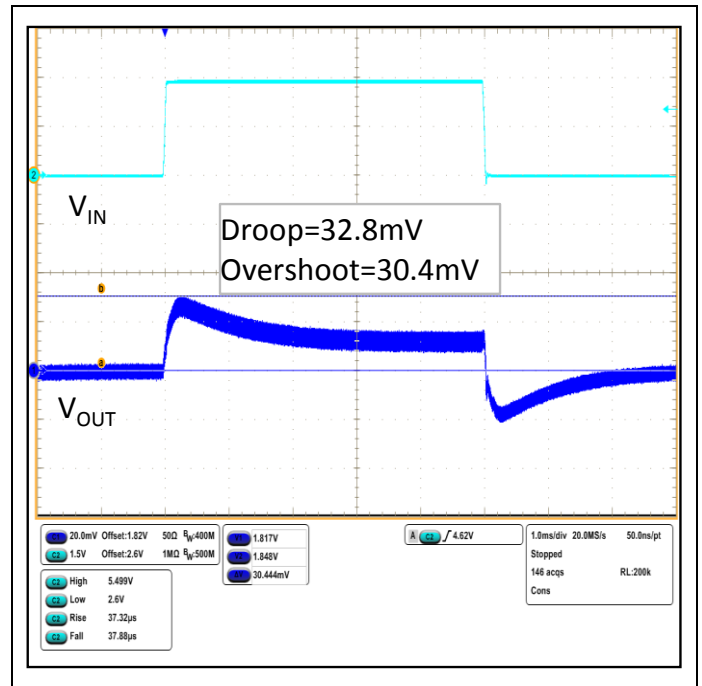

Figure 30. Line Transient Response
($V_{IN}=2.6V \leftrightarrow 5.5V$, $t_r=t_f=48\mu s$, $V_{OUT}=1.8V$, $I_{OUT}=500mA$)

Typical Performance Curves - continued
(Unless otherwise specified Ta=25°C)

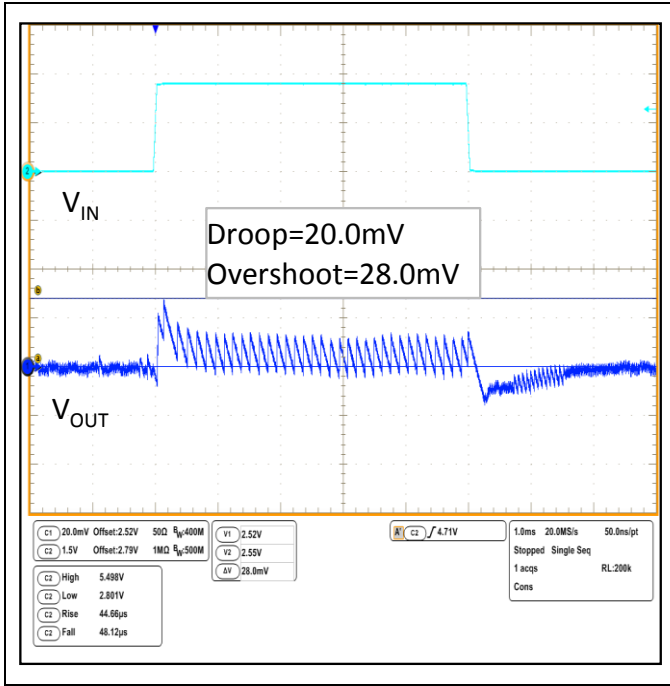

Figure 31. Line Transient Response
($V_{IN}=2.8V \leftrightarrow 5.5V$, $t_r=t_f=45\mu s$, $V_{OUT}=2.5V$, $I_{OUT}=1mA$)

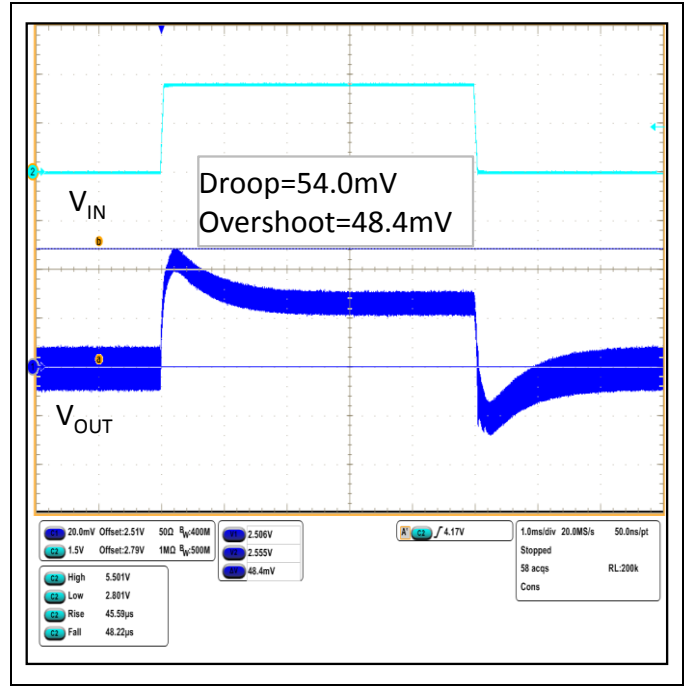

Figure 32. Line Transient Response
($V_{IN}=2.8V \leftrightarrow 5.5V$, $t_r=t_f=45\mu s$, $V_{OUT}=2.5V$, $I_{OUT}=500mA$)

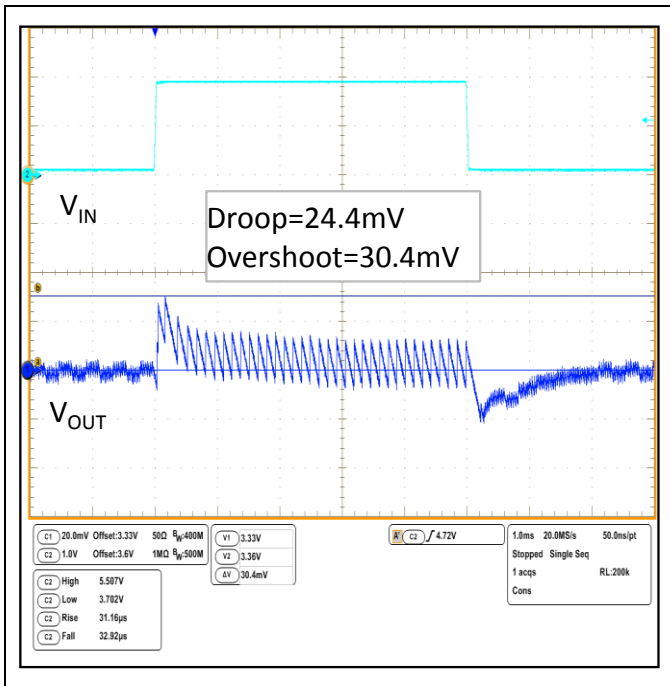

Figure 33. Line Transient Response
($V_{IN}=3.7V \leftrightarrow 5.5V$, $t_r=t_f=30\mu s$, $V_{OUT}=3.3V$, $I_{OUT}=1mA$)

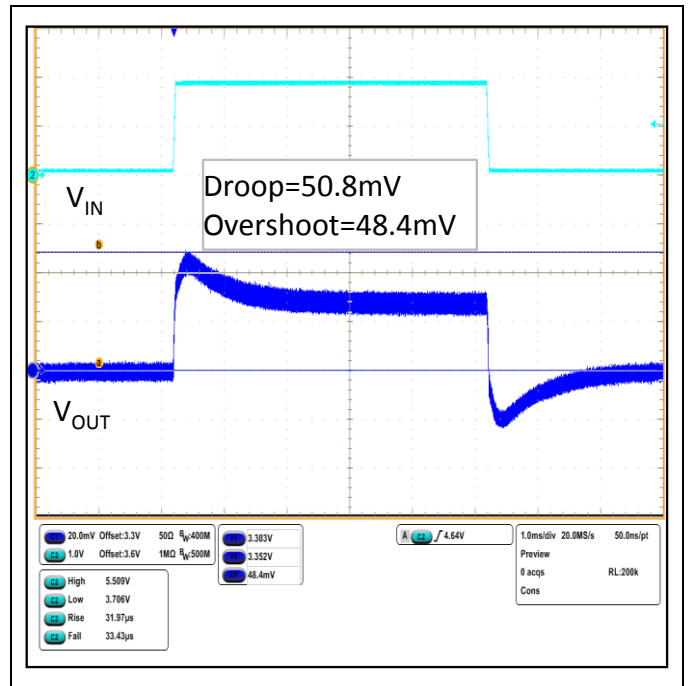

Figure 34. Line Transient Response
($V_{IN}=3.7V \leftrightarrow 5.5V$, $t_r=t_f=30\mu s$, $V_{OUT}=3.3V$, $I_{OUT}=500mA$)

Typical Performance Curves - continued
(Unless otherwise specified Ta=25°C)

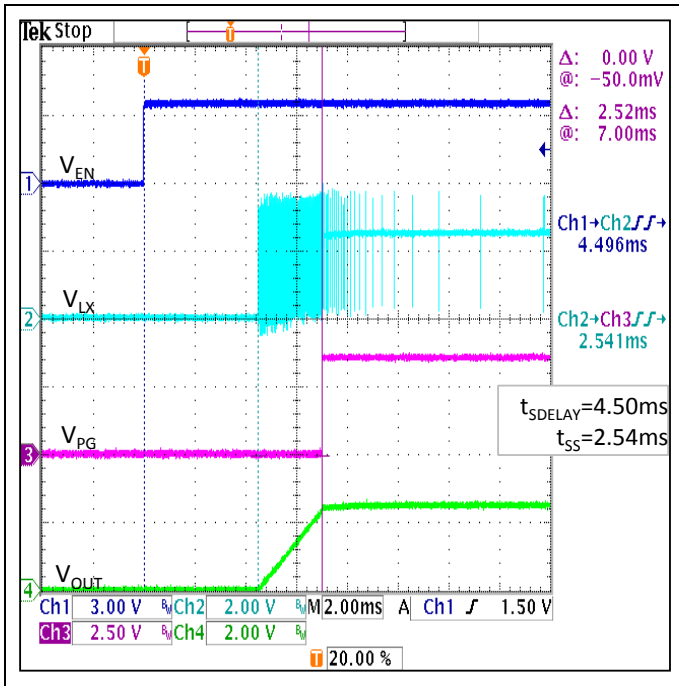

Figure 35. Startup
(V_{IN}=3.6V, V_{OUT}=2.5V, I_{OUT}=0mA, EN=0→V_{IN})

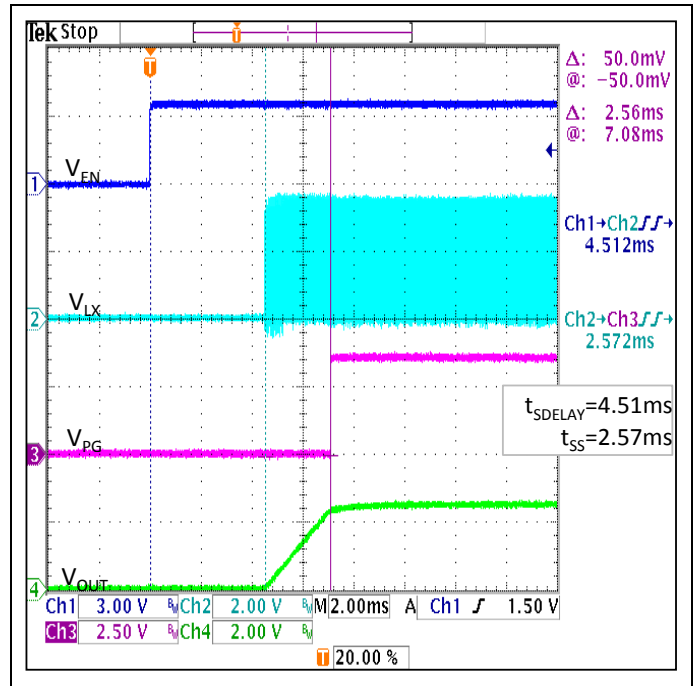

Figure 36. Startup
(V_{IN}=3.6V, V_{OUT}=2.5V, I_{OUT}=500mA, EN=0→V_{IN})

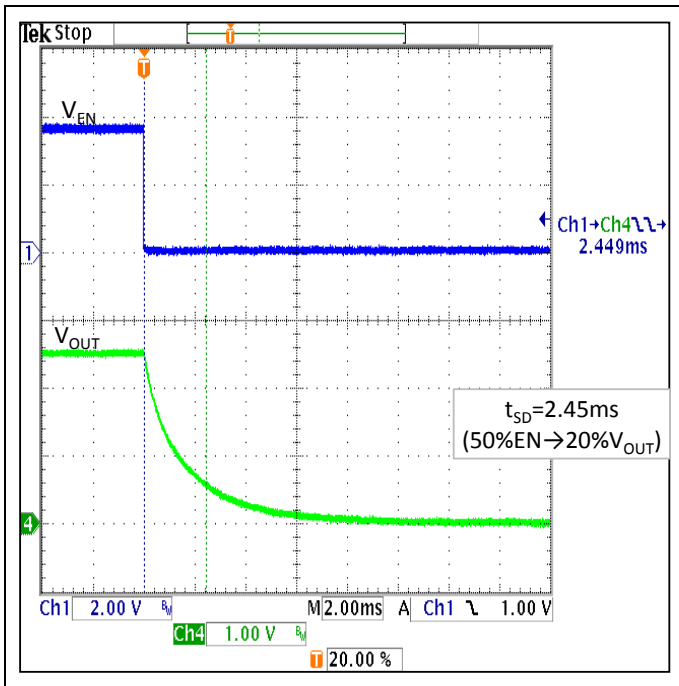

Figure 37. Shutdown
(V_{IN}=3.6V, V_{OUT}=2.5V, I_{OUT}=0mA, EN=V_{IN}→0)

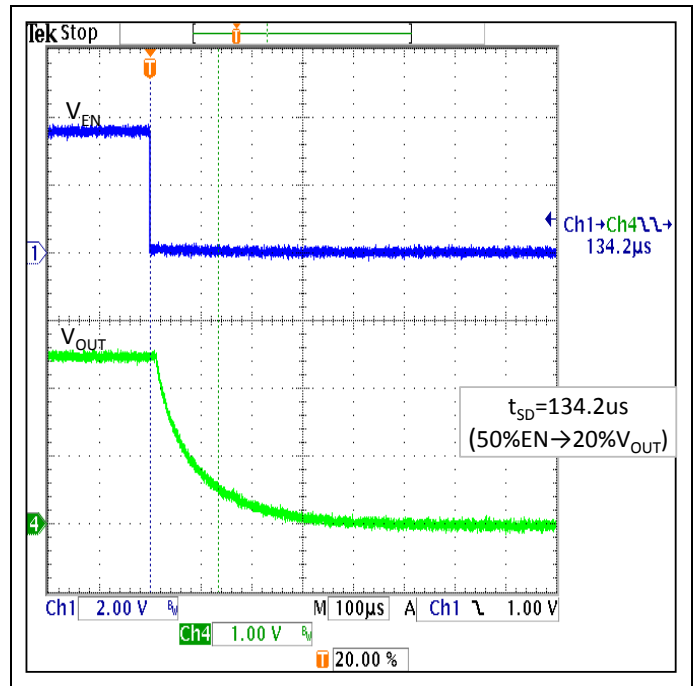

Figure 38. Shutdown
(V_{IN}=3.6V, V_{OUT}=2.5V, I_{OUT}=500mA, EN=V_{IN}→0)

Typical Performance Curves - continued
(Unless otherwise specified Ta=25°C)

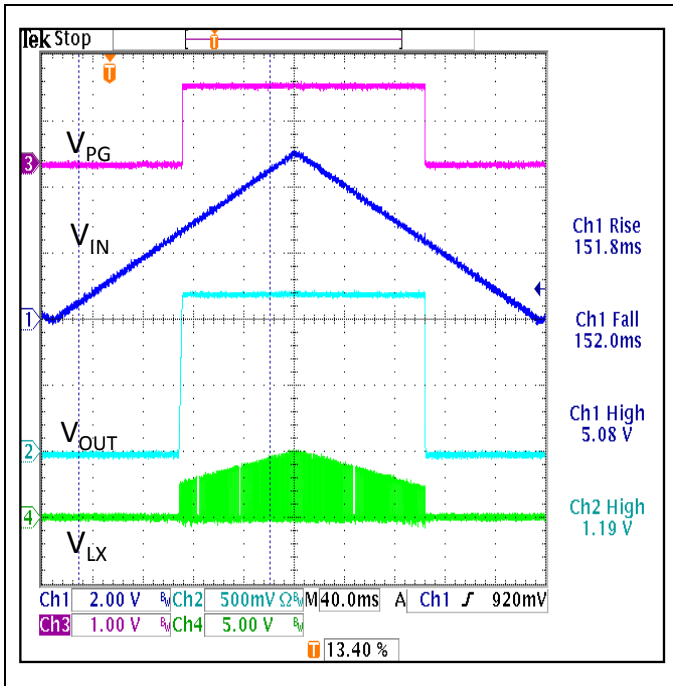

Figure 39. Input Voltage Ramp Up/Down
($V_{IN}=0V \leftrightarrow 5.0V$, $V_{OUT}=1.2V$, $I_{OUT}=500mA$, $PG=V_{OUT}$)

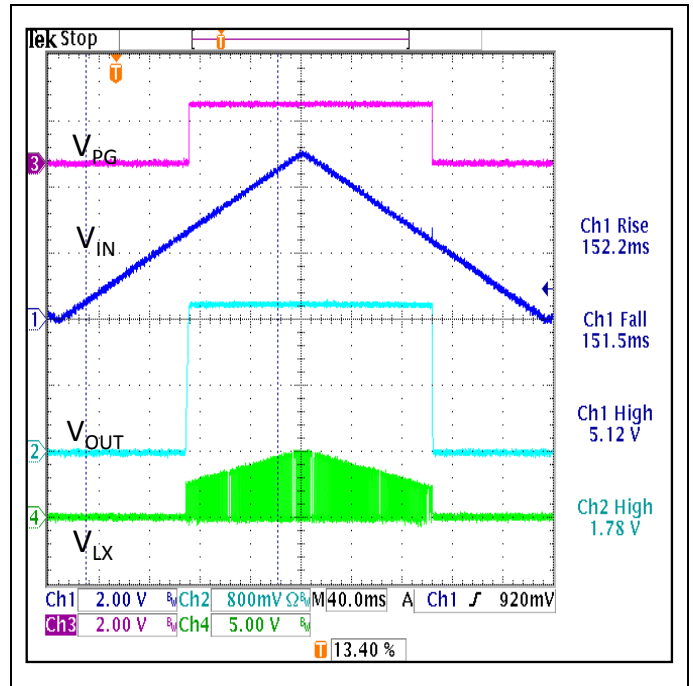

Figure 40. Input Voltage Ramp Up/Down
($V_{IN}=0V \leftrightarrow 5.0V$, $V_{OUT}=1.8V$, $I_{OUT}=500mA$, $PG=V_{OUT}$)

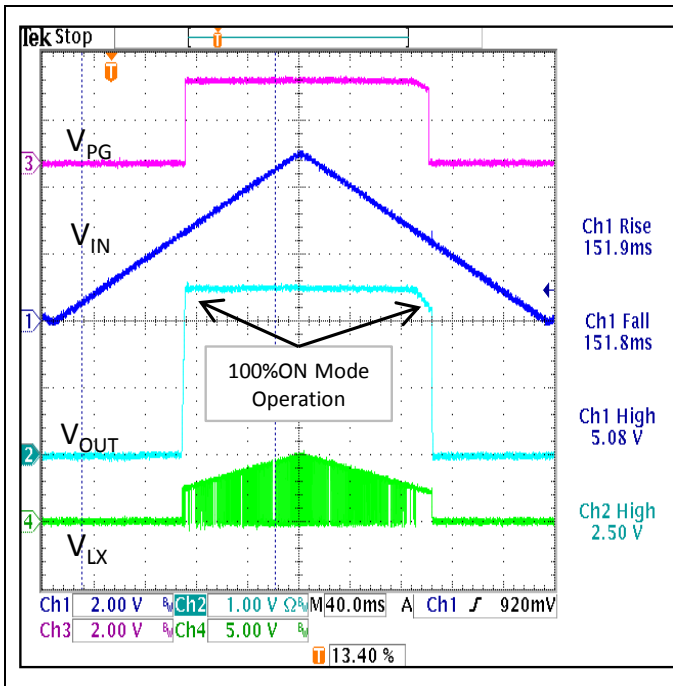

Figure 41. Input Voltage Ramp Up/Down
($V_{IN}=0V \leftrightarrow 5.0V$, $V_{OUT}=2.5V$, $I_{OUT}=500mA$, $PG=V_{OUT}$)

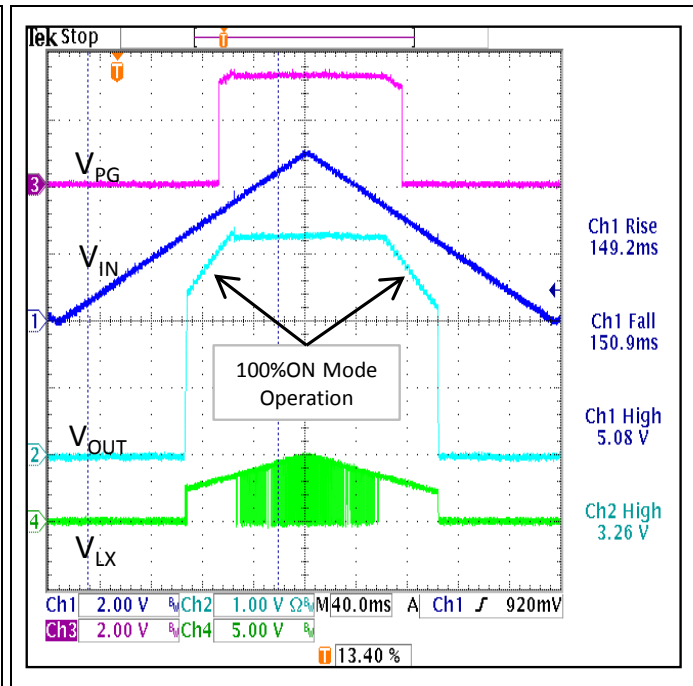

Figure 42. Input Voltage Ramp Up/Down
($V_{IN}=0V \leftrightarrow 5.0V$, $V_{OUT}=3.3V$, $I_{OUT}=500mA$, $PG=V_{OUT}$)

Timing Chart

After BD70522GUL is enabled, the internal reference voltage is booted up. When the startup delay time t_{SDelay} has expired, the switching is started by the soft-start operation, and the output voltage is ramped up to the set voltage (V_{OUTSET}) which is determined by the states of VSEL1 and VSEL2 during the startup delay in normal operation.

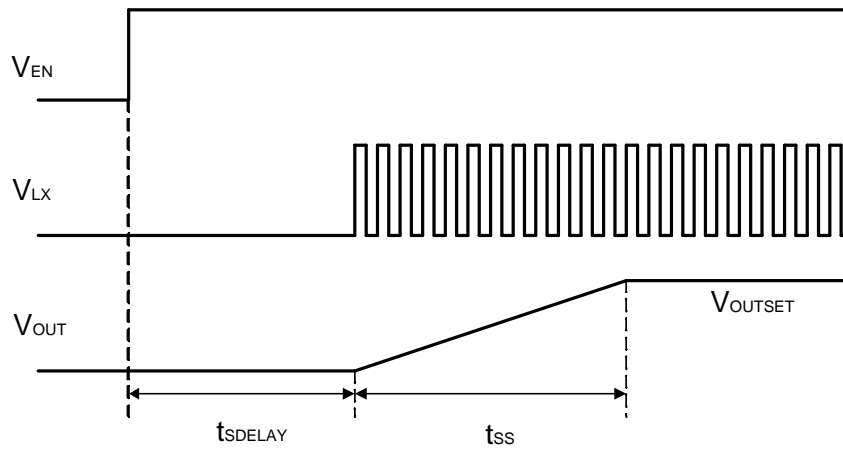

Figure 43. Timing Chart

Application Examples

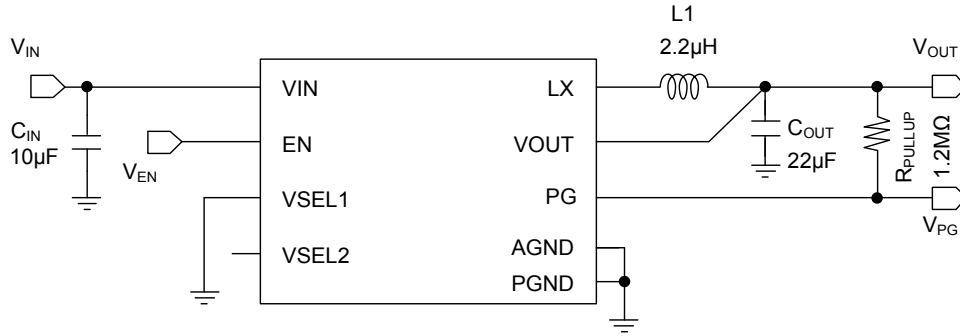

Figure 44. Application Example ($V_{OUT}=1.2V$)

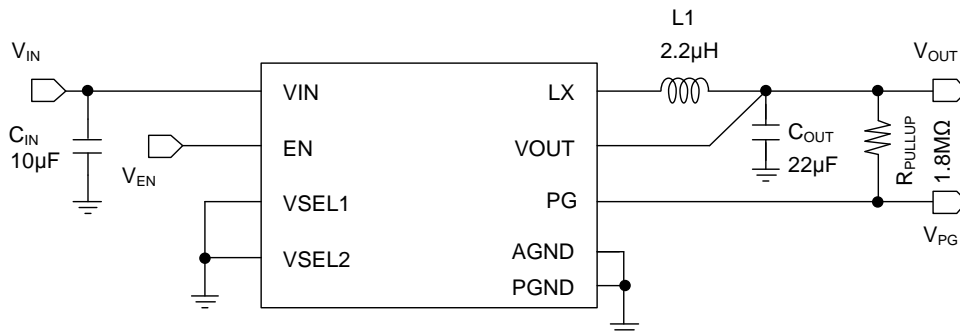

Figure 45. Application Example ($V_{OUT}=1.8V$)

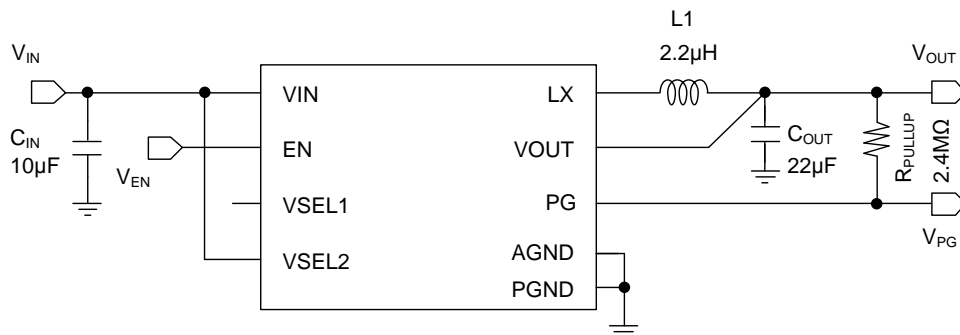

Figure 46. Application Example ($V_{OUT}=2.5V$)

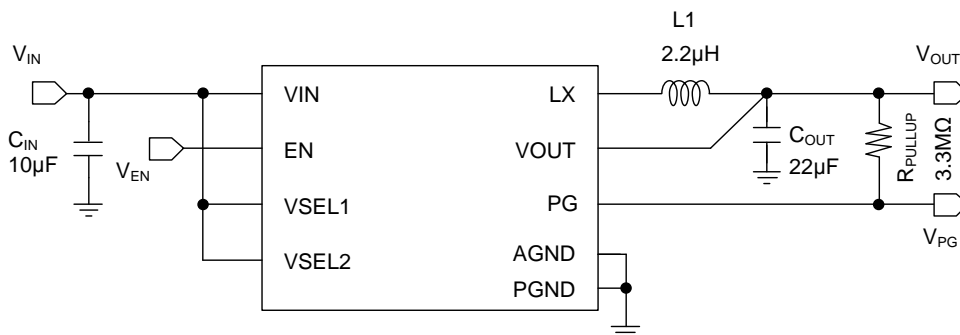
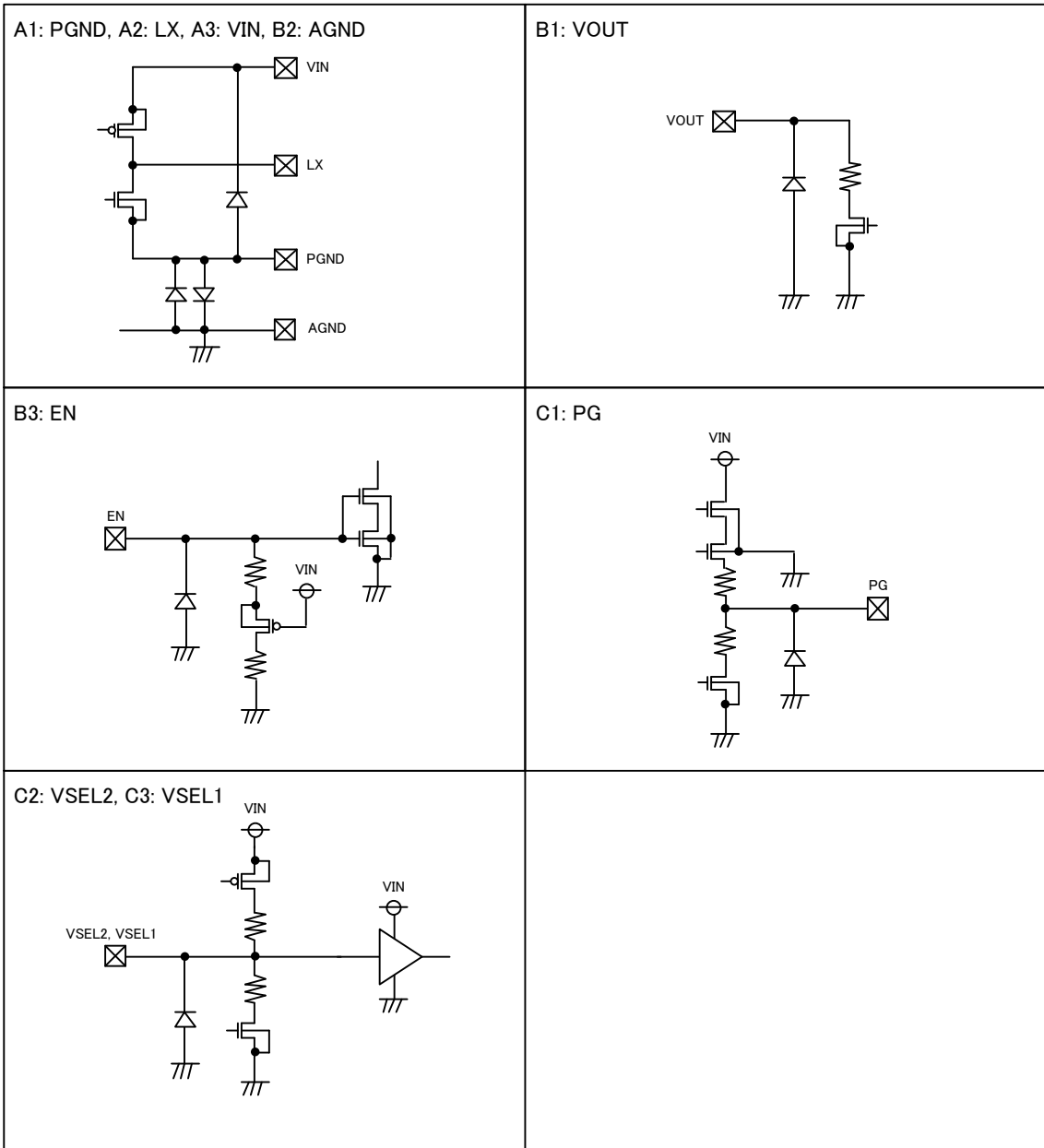

Figure 47. Application Example ($V_{OUT}=3.3V$)

I/O Equivalence Circuits



Operational Notes

1. Reverse Connection of Power Supply

Connecting the power supply in reverse polarity can damage the IC. Take precautions against reverse polarity when connecting the power supply, such as mounting an external diode between the power supply and the IC's power supply pins.

2. Power Supply Lines

Design the PCB layout pattern to provide low impedance supply lines. Furthermore, connect a capacitor to ground at all power supply pins. Consider the effect of temperature and aging on the capacitance value when using electrolytic capacitors.

3. Ground Voltage

Ensure that no pins are at a voltage below that of the ground pin at any time, even during transient condition.

4. Ground Wiring Pattern

When using both small-signal and large-current ground traces, the two ground traces should be routed separately but connected to a single ground at the reference point of the application board to avoid fluctuations in the small-signal ground caused by large currents. Also ensure that the ground traces of external components do not cause variations on the ground voltage. The ground lines must be as short and thick as possible to reduce line impedance.

5. Recommended Operating Conditions

The function and operation of the IC are guaranteed within the range specified by the recommended operating conditions. The characteristic values are guaranteed only under the conditions of each item specified by the electrical characteristics.

6. Inrush Current

When power is first supplied to the IC, it is possible that the internal logic may be unstable and inrush current may flow instantaneously due to the internal powering sequence and delays, especially if the IC has more than one power supply. Therefore, give special consideration to power coupling capacitance, power wiring, width of ground wiring, and routing of connections.

7. Operation Under Strong Electromagnetic Field

Operating the IC in the presence of a strong electromagnetic field may cause the IC to malfunction.

8. Testing on Application Boards

When testing the IC on an application board, connecting a capacitor directly to a low-impedance output pin may subject the IC to stress. Always discharge capacitors completely after each process or step. The IC's power supply should always be turned off completely before connecting or removing it from the test setup during the inspection process. To prevent damage from static discharge, ground the IC during assembly and use similar precautions during transport and storage.

9. Inter-pin Short and Mounting Errors

Ensure that the direction and position are correct when mounting the IC on the PCB. Incorrect mounting may result in damaging the IC. Avoid nearby pins being shorted to each other especially to ground, power supply and output pin. Inter-pin shorts could be due to many reasons such as metal particles, water droplets (in very humid environment) and unintentional solder bridge deposited in between pins during assembly to name a few.

10. Unused Input Pins

Input pins of an IC are often connected to the gate of a MOS transistor. The gate has extremely high impedance and extremely low capacitance. If left unconnected, the electric field from the outside can easily charge it. The small charge acquired in this way is enough to produce a significant effect on the conduction through the transistor and cause unexpected operation of the IC. So unless otherwise specified, unused input pins should be connected to the power supply or ground line.

11. Regarding the Input Pin of the IC

This monolithic IC contains P+ isolation and P substrate layers between adjacent elements in order to keep them isolated. P-N junctions are formed at the intersection of the P layers with the N layers of other elements, creating a parasitic diode or transistor. For example (refer to figure below):

When $GND > Pin\ A$ and $GND > Pin\ B$, the P-N junction operates as a parasitic diode.

When $GND > Pin\ B$, the P-N junction operates as a parasitic transistor.

Parasitic diodes inevitably occur in the structure of the IC. The operation of parasitic diodes can result in mutual interference among circuits, operational faults, or physical damage. Therefore, conditions that cause these diodes to operate, such as applying a voltage lower than the GND voltage to an input pin (and thus to the P substrate) should be avoided.

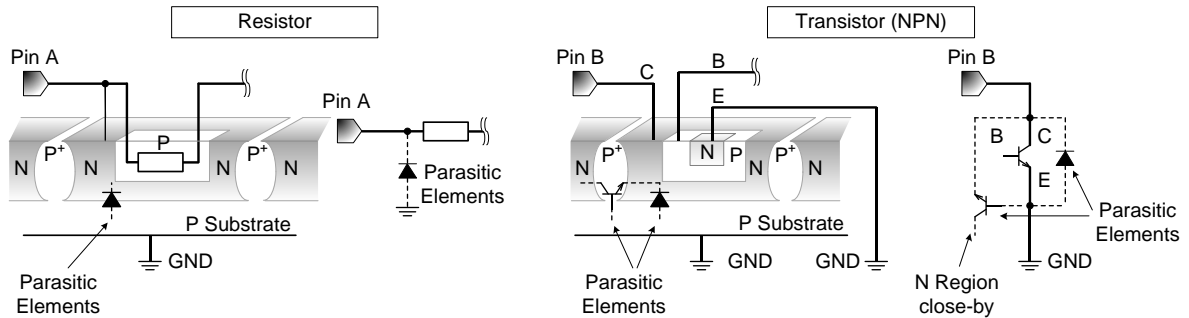

Figure xx. Example of monolithic IC structure

12. Ceramic Capacitor

When using a ceramic capacitor, determine a capacitance value considering the change of capacitance with temperature and the decrease in nominal capacitance due to DC bias and others.

13. Area of Safe Operation (ASO)

Operate the IC such that the output voltage, output current, and the maximum junction temperature rating are all within the Area of Safe Operation (ASO).

14. Thermal Shutdown Circuit(TSD)

This IC has a built-in thermal shutdown circuit that prevents heat damage to the IC. Normal operation should always be within the IC's maximum junction temperature rating. If however the rating is exceeded for a continued period, the junction temperature (T_j) will rise which will activate the TSD circuit that will turn OFF power output pins. When the T_j falls below the TSD threshold, the circuits are automatically restored to normal operation.

Note that the TSD circuit operates in a situation that exceeds the absolute maximum ratings and therefore, under no circumstances, should the TSD circuit be used in a set design or for any purpose other than protecting the IC from heat damage.

15. Over Current Protection Circuit (OCP)

This IC incorporates an integrated overcurrent protection circuit that is activated when the load is shorted. This protection circuit is effective in preventing damage due to sudden and unexpected incidents. However, the IC should not be used in applications characterized by continuous operation or transitioning of the protection circuit.

16. Disturbance Light

In a device where a portion of silicon is exposed to light such as in a WL-CSP and chip products, IC characteristics may be affected due to photoelectric effect. For this reason, it is recommended to come up with countermeasures that will prevent the chip from being exposed to light.

Physical Dimension and Packing Information

| | |
|--------------|-----------|
| Package Name | VCSP50L1C |
|--------------|-----------|

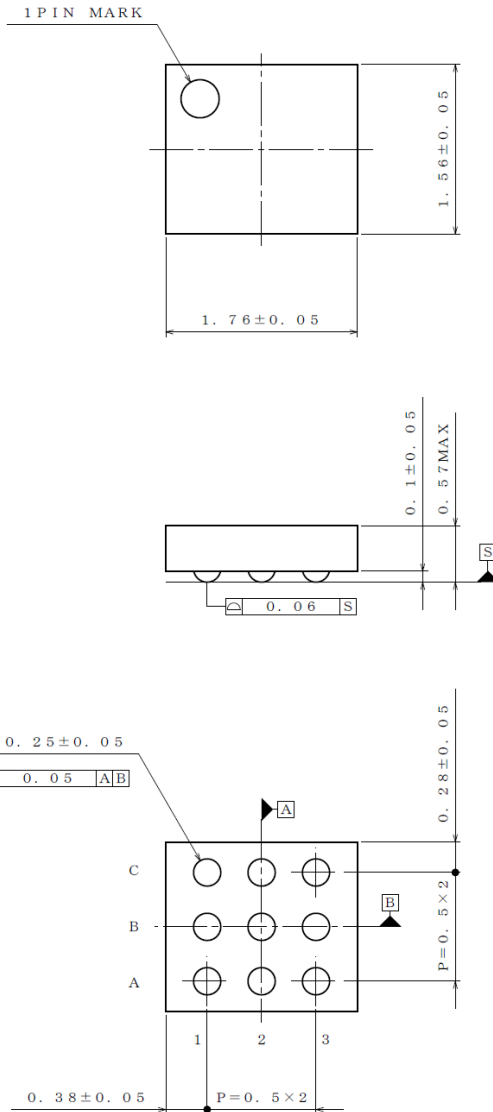

Drawing No : EX961-5003

(UNIT : mm)

< Tape and Reel Information >

| | |
|-------------------|--|
| Tape | Embossed carrier tape |
| Quantity | 3,000pcs/Reel |
| Direction of feed | E2 The direction is the pin 1 of product is at the upper left when you hold reel on the left hand and you pull out the tape on the right hand |

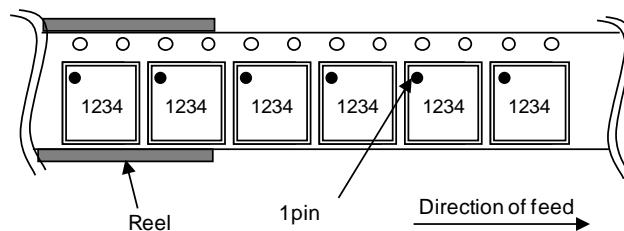

Revision History

| Date | Revision | Changes |
|-------------|----------|---|
| 10.Aug.2017 | 001 | New Release |
| 21.Aug.2017 | 002 | Corrected the limits of "I _{LIMITL} " and "I _{LIMITH2} " in Electrical Characteristics. |
| | | Improved the description of OCL. |
| | | Improved Figure 5, Marking Diagram. |

Notice

Precaution on using ROHM Products

- Our Products are designed and manufactured for application in ordinary electronic equipment (such as AV equipment, OA equipment, telecommunication equipment, home electronic appliances, amusement equipment, etc.). If you intend to use our Products in devices requiring extremely high reliability (such as medical equipment ^(Note 1), transport equipment, traffic equipment, aircraft/spacecraft, nuclear power controllers, fuel controllers, car equipment including car accessories, safety devices, etc.) and whose malfunction or failure may cause loss of human life, bodily injury or serious damage to property ("Specific Applications"), please consult with the ROHM sales representative in advance. Unless otherwise agreed in writing by ROHM in advance, ROHM shall not be in any way responsible or liable for any damages, expenses or losses incurred by you or third parties arising from the use of any ROHM's Products for Specific Applications.

(Note1) Medical Equipment Classification of the Specific Applications

| JAPAN | USA | EU | CHINA |
|-----------|-----------|------------|-----------|
| CLASS III | CLASS III | CLASS II b | CLASS III |
| CLASS IV | | CLASS III | |

- ROHM designs and manufactures its Products subject to strict quality control system. However, semiconductor products can fail or malfunction at a certain rate. Please be sure to implement, at your own responsibilities, adequate safety measures including but not limited to fail-safe design against the physical injury, damage to any property, which a failure or malfunction of our Products may cause. The following are examples of safety measures:
 - Installation of protection circuits or other protective devices to improve system safety
 - Installation of redundant circuits to reduce the impact of single or multiple circuit failure
- Our Products are designed and manufactured for use under standard conditions and not under any special or extraordinary environments or conditions, as exemplified below. Accordingly, ROHM shall not be in any way responsible or liable for any damages, expenses or losses arising from the use of any ROHM's Products under any special or extraordinary environments or conditions. If you intend to use our Products under any special or extraordinary environments or conditions (as exemplified below), your independent verification and confirmation of product performance, reliability, etc. prior to use, must be necessary:
 - Use of our Products in any types of liquid, including water, oils, chemicals, and organic solvents
 - Use of our Products outdoors or in places where the Products are exposed to direct sunlight or dust
 - Use of our Products in places where the Products are exposed to sea wind or corrosive gases, including Cl₂, H₂S, NH₃, SO₂, and NO₂
 - Use of our Products in places where the Products are exposed to static electricity or electromagnetic waves
 - Use of our Products in proximity to heat-producing components, plastic cords, or other flammable items
 - Sealing or coating our Products with resin or other coating materials
 - Use of our Products without cleaning residue of flux (even if you use no-clean type fluxes, cleaning residue of flux is recommended); or Washing our Products by using water or water-soluble cleaning agents for cleaning residue after soldering
 - Use of the Products in places subject to dew condensation
- The Products are not subject to radiation-proof design.
- Please verify and confirm characteristics of the final or mounted products in using the Products.
- In particular, if a transient load (a large amount of load applied in a short period of time, such as pulse. is applied, confirmation of performance characteristics after on-board mounting is strongly recommended. Avoid applying power exceeding normal rated power; exceeding the power rating under steady-state loading condition may negatively affect product performance and reliability.
- De-rate Power Dissipation depending on ambient temperature. When used in sealed area, confirm that it is the use in the range that does not exceed the maximum junction temperature.
- Confirm that operation temperature is within the specified range described in the product specification.
- ROHM shall not be in any way responsible or liable for failure induced under deviant condition from what is defined in this document.

Precaution for Mounting / Circuit board design

- When a highly active halogenous (chlorine, bromine, etc.) flux is used, the residue of flux may negatively affect product performance and reliability.
- In principle, the reflow soldering method must be used on a surface-mount products, the flow soldering method must be used on a through hole mount products. If the flow soldering method is preferred on a surface-mount products, please consult with the ROHM representative in advance.

For details, please refer to ROHM Mounting specification

Precautions Regarding Application Examples and External Circuits

1. If change is made to the constant of an external circuit, please allow a sufficient margin considering variations of the characteristics of the Products and external components, including transient characteristics, as well as static characteristics.
2. You agree that application notes, reference designs, and associated data and information contained in this document are presented only as guidance for Products use. Therefore, in case you use such information, you are solely responsible for it and you must exercise your own independent verification and judgment in the use of such information contained in this document. ROHM shall not be in any way responsible or liable for any damages, expenses or losses incurred by you or third parties arising from the use of such information.

Precaution for Electrostatic

This Product is electrostatic sensitive product, which may be damaged due to electrostatic discharge. Please take proper caution in your manufacturing process and storage so that voltage exceeding the Products maximum rating will not be applied to Products. Please take special care under dry condition (e.g. Grounding of human body / equipment / solder iron, isolation from charged objects, setting of Ionizer, friction prevention and temperature / humidity control).

Precaution for Storage / Transportation

1. Product performance and soldered connections may deteriorate if the Products are stored in the places where:
 - [a] the Products are exposed to sea winds or corrosive gases, including Cl₂, H₂S, NH₃, SO₂, and NO₂
 - [b] the temperature or humidity exceeds those recommended by ROHM
 - [c] the Products are exposed to direct sunshine or condensation
 - [d] the Products are exposed to high Electrostatic
2. Even under ROHM recommended storage condition, solderability of products out of recommended storage time period may be degraded. It is strongly recommended to confirm solderability before using Products of which storage time is exceeding the recommended storage time period.
3. Store / transport cartons in the correct direction, which is indicated on a carton with a symbol. Otherwise bent leads may occur due to excessive stress applied when dropping of a carton.
4. Use Products within the specified time after opening a humidity barrier bag. Baking is required before using Products of which storage time is exceeding the recommended storage time period.

Precaution for Product Label

A two-dimensional barcode printed on ROHM Products label is for ROHM's internal use only.

Precaution for Disposition

When disposing Products please dispose them properly using an authorized industry waste company.

Precaution for Foreign Exchange and Foreign Trade act

Since concerned goods might be fallen under listed items of export control prescribed by Foreign exchange and Foreign trade act, please consult with ROHM in case of export.

Precaution Regarding Intellectual Property Rights

1. All information and data including but not limited to application example contained in this document is for reference only. ROHM does not warrant that foregoing information or data will not infringe any intellectual property rights or any other rights of any third party regarding such information or data.
2. ROHM shall not have any obligations where the claims, actions or demands arising from the combination of the Products with other articles such as components, circuits, systems or external equipment (including software).
3. No license, expressly or implied, is granted hereby under any intellectual property rights or other rights of ROHM or any third parties with respect to the Products or the information contained in this document. Provided, however, that ROHM will not assert its intellectual property rights or other rights against you or your customers to the extent necessary to manufacture or sell products containing the Products, subject to the terms and conditions herein.

Other Precaution

1. This document may not be reprinted or reproduced, in whole or in part, without prior written consent of ROHM.
2. The Products may not be disassembled, converted, modified, reproduced or otherwise changed without prior written consent of ROHM.
3. In no event shall you use in any way whatsoever the Products and the related technical information contained in the Products or this document for any military purposes, including but not limited to, the development of mass-destruction weapons.
4. The proper names of companies or products described in this document are trademarks or registered trademarks of ROHM, its affiliated companies or third parties.

General Precaution

1. Before you use our Products, you are requested to carefully read this document and fully understand its contents. ROHM shall not be in any way responsible or liable for failure, malfunction or accident arising from the use of any ROHM's Products against warning, caution or note contained in this document.
2. All information contained in this document is current as of the issuing date and subject to change without any prior notice. Before purchasing or using ROHM's Products, please confirm the latest information with a ROHM sales representative.
3. The information contained in this document is provided on an "as is" basis and ROHM does not warrant that all information contained in this document is accurate and/or error-free. ROHM shall not be in any way responsible or liable for any damages, expenses or losses incurred by you or third parties resulting from inaccuracy or errors of or concerning such information.



BD70522GUL - Web Page

[Distribution Inventory](#)

| | |
|-----------------------------|------------|
| Part Number | BD70522GUL |
| Package | VCSP50L1C |
| Unit Quantity | 3000 |
| Minimum Package Quantity | 3000 |
| Packing Type | Taping |
| Constitution Materials List | inquiry |
| RoHS | Yes |

Mouser Electronics

Authorized Distributor

Click to View Pricing, Inventory, Delivery & Lifecycle Information:

[ROHM Semiconductor:](#)

[BD70522GUL-EVK-101](#)

Компания «Океан Электроники» предлагает заключение долгосрочных отношений при поставках импортных электронных компонентов на взаимовыгодных условиях!

Наши преимущества:

- Поставка оригинальных импортных электронных компонентов напрямую с производств Америки, Европы и Азии, а так же с крупнейших складов мира;
- Широкая линейка поставок активных и пассивных импортных электронных компонентов (более 30 млн. наименований);
- Поставка сложных, дефицитных, либо снятых с производства позиций;
- Оперативные сроки поставки под заказ (от 5 рабочих дней);
- Экспресс доставка в любую точку России;
- Помощь Конструкторского Отдела и консультации квалифицированных инженеров;
- Техническая поддержка проекта, помощь в подборе аналогов, поставка прототипов;
- Поставка электронных компонентов под контролем ВП;
- Система менеджмента качества сертифицирована по Международному стандарту ISO 9001;
- При необходимости вся продукция военного и аэрокосмического назначения проходит испытания и сертификацию в лаборатории (по согласованию с заказчиком);
- Поставка специализированных компонентов военного и аэрокосмического уровня качества (Xilinx, Altera, Analog Devices, Intersil, Interpoint, Microsemi, Actel, Aeroflex, Peregrine, VPT, Syfer, Eurofarad, Texas Instruments, MS Kennedy, Miteq, Cobham, E2V, MA-COM, Hittite, Mini-Circuits, General Dynamics и др.);

Компания «Океан Электроники» является официальным дистрибьютором и эксклюзивным представителем в России одного из крупнейших производителей разъемов военного и аэрокосмического назначения «**JONHON**», а так же официальным дистрибьютором и эксклюзивным представителем в России производителя высокотехнологичных и надежных решений для передачи СВЧ сигналов «**FORSTAR**».



JONHON

«**JONHON**» (основан в 1970 г.)

Разъемы специального, военного и аэрокосмического назначения:

(Применяются в военной, авиационной, аэрокосмической, морской, железнодорожной, горно- и нефтедобывающей отраслях промышленности)

«**FORSTAR**» (основан в 1998 г.)

ВЧ соединители, коаксиальные кабели, кабельные сборки и микроволновые компоненты:

(Применяются в телекоммуникациях гражданского и специального назначения, в средствах связи, РЛС, а так же военной, авиационной и аэрокосмической отраслях промышленности).



Телефон: 8 (812) 309-75-97 (многоканальный)

Факс: 8 (812) 320-03-32

Электронная почта: ocean@oceanchips.ru

Web: <http://oceanchips.ru/>

Адрес: 198099, г. Санкт-Петербург, ул. Калинина, д. 2, корп. 4, лит. А