

**Single/Dual Low Bias Current, Low Voltage, Rail-to-Rail
Input/Output CMOS Operational Amplifiers**
AZV831/2

General Description

The AZV831/AZV832 is single/dual channels rail-to-rail input and output amplifier, which provides a wide input common-mode voltage range and output voltage swing capability for maximum signal swings in low supply voltage applications. The device is fully specified to operate from 1.6V to 5.0V single supply, or $\pm 0.8V$ and $\pm 2.5V$ dual supply applications. It features very low supply current dissipation $70\mu A$ per channel, which is well suitable for today's low-voltage and/or portable systems.

The AZV831/AZV832 features optimal performance in very low bias current of $1pA$, which enables the IC to be used for integrators, photodiode amplifiers, and piezoelectric sensors etc. The device has typical $0.5mV$ input offset voltage and provides $1MHz$ bandwidth.

The AZV831/AZV832 adopts the latest packaging technology to meet the most demanding space-constraint applications. The AZV831 is available in standard SOT-23-5 and SC-70-5 packages. The AZV832 is offered in the traditional MSOP-8 and SOIC-8 packages.

Features

- Single Supply Voltage Range: 1.6V to 5.5V
- Ultra-low Input Bias Current: $1pA$ (Typ.)
- Offset Voltage: $0.5mV$ (Typ.), $2.5mV$ (Max.)
- Rail-to-Rail Input
 V_{CM} : $300mV$ beyond Rails @ $V_{CC}=5V$
- Rail-to-Rail Output Swing:
 $10k\Omega$ Load: $4mV$ from Rail
 $1k\Omega$ Load: $25mV$ from Rail
- Supply Current: $70\mu A$ /Amplifier
- Unity Gain Stable
 Gain Bandwidth Product: $1.0MHz$
- Slew Rate: $0.45V/\mu s$ @ $V_{CC}=5.0V$
- Operation Ambient Temperature Range: $-40^{\circ}C$ to $85^{\circ}C$

Applications

- Sensors
- Photodiode Amplification
- Battery-Powered Instrumentation
- Pulse Blood Oximeter, Glucose Meter

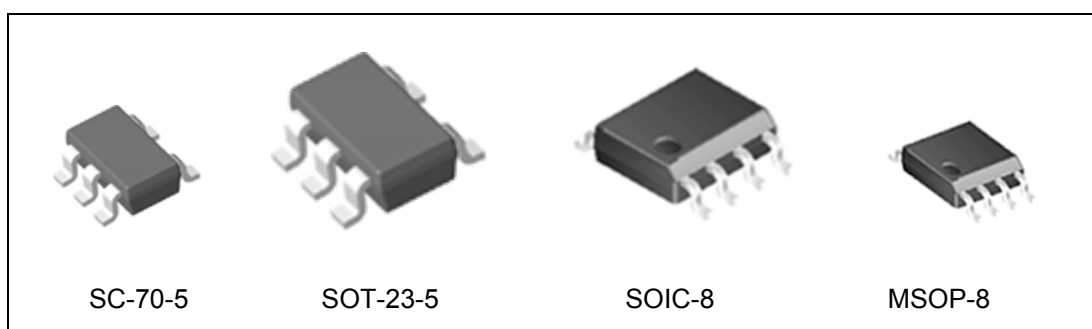

Figure 1. Package Types of AZV831/AZV832

**Single/Dual Low Bias Current, Low Voltage, Rail-to-Rail
Input/Output CMOS Operational Amplifiers**

AZV831/2

Pin Configuration

KS/K Package
(SC-70-5/SOT-23-5)

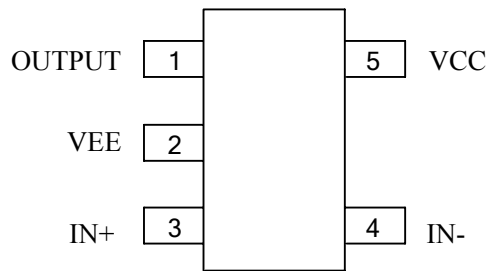

AZV831

M/MM Package
(SOIC-8/MSOP-8)

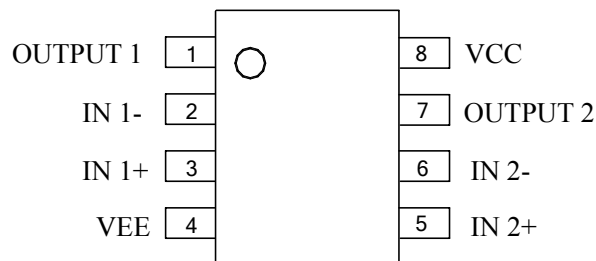

AZV832

Figure 2. Pin Configuration of AZV831/2 (Top View)

**Single/Dual Low Bias Current, Low Voltage, Rail-to-Rail
Input/Output CMOS Operational Amplifiers**

AZV831/2

Function Block Diagram

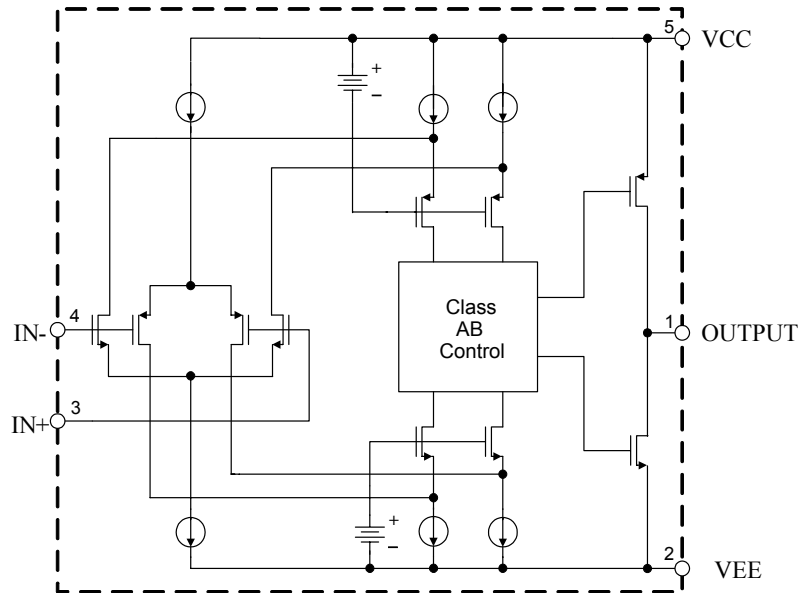

For AZV831

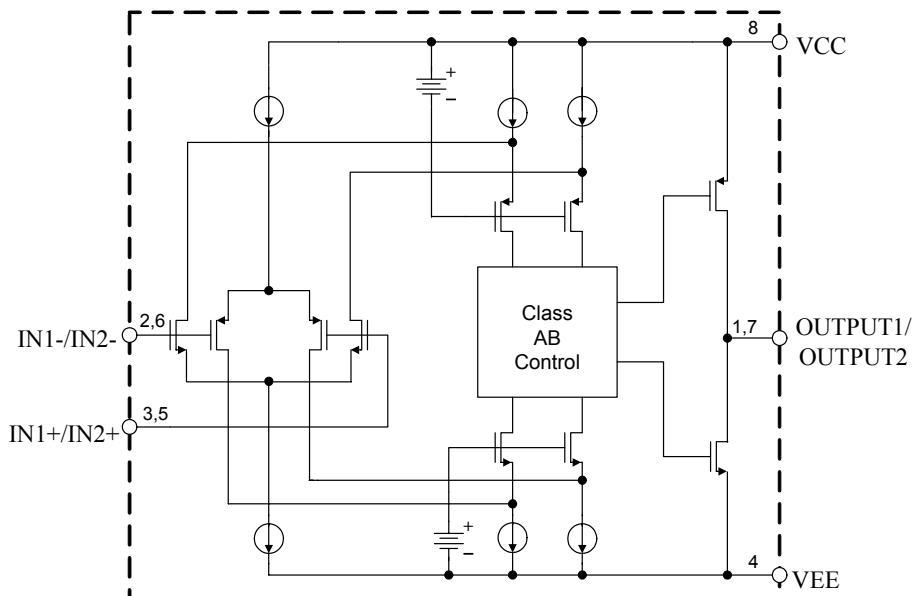

For AZV832/Amplifier

Figure 3. Functional Block Diagram of AZV831/2



**Single/Dual Low Bias Current, Low Voltage, Rail-to-Rail
Input/Output CMOS Operational Amplifiers**

AZV831/2

Ordering Information

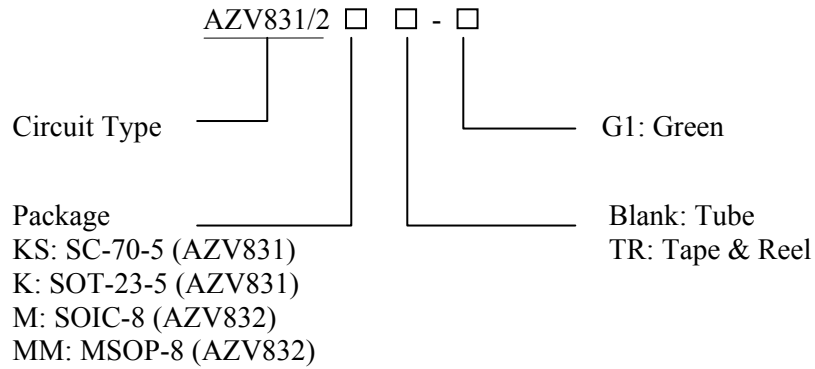

Package	Temperature Range	Part Number	Marking ID	Packing Type
SC-70-5	-40 to 85°C	AZV831KSTR-G1	L3	Tape & Reel
SOT-23-5	-40 to 85°C	AZV831KTR-G1	G4D	Tape & Reel
SOIC-8	-40 to 85°C	AZV832M-G1	832M-G1	Tube
		AZV832MTR-G1	832M-G1	Tape & Reel
MSOP-8	-40 to 85°C	AZV832MM-G1	832MM-G1	Tube
		AZV832MMTR-G1	832MM-G1	Tape & Reel

BCD Semiconductor's Pb-free products, as designated with "G1" suffix in the part number, are RoHS compliant and green.

**Single/Dual Low Bias Current, Low Voltage, Rail-to-Rail
Input/Output CMOS Operational Amplifiers****AZV831/2****Absolute Maximum Ratings (Note 1)**

Parameter	Symbol	Value	Unit
Power Supply Voltage	V_{CC}	6.0	V
Differential Input Voltage	V_{ID}	6.0	V
Input Voltage	V_{IN}	-0.3 to $V_{CC}+0.5$	V
Operating Junction Temperature	T_J	150	°C
Thermal Resistance (Junction to Ambient)	θ_{JA}	SC-70-5	270
		SOT-23-5	220
		SOIC-8	150
		MSOP-8	200
Storage Temperature Range	T_{STG}	-65 to 150	°C
Lead Temperature (Soldering,10 Seconds)	T_{LEAD}	260	°C
ESD (Human Body Model)		4000	V
ESD (Machine Model)		300	V

Note 1: Stresses greater than those listed under “Absolute Maximum Ratings” may cause permanent damage to the device. These are stress ratings only, and functional operation of the device at these or any other conditions beyond those indicated under “Recommended Operating Conditions” is not implied. Exposure to “Absolute Maximum Ratings” for extended periods may affect device reliability.

Recommended Operating Conditions

Parameter	Symbol	Min	Max	Unit
Supply Voltage	V_{CC}	1.6	5.5	V
Operation Ambient Temperature Range	T_A	-40	85	°C

**Single/Dual Low Bias Current, Low Voltage, Rail-to-Rail
Input/Output CMOS Operational Amplifiers****AZV831/2****1.6V DC Electrical Characteristics** $V_{CC}=1.6V$, $V_{EE}=0$, $V_{OUT}=V_{CC}/2$, $V_{CM}=V_{CC}/2$, $T_A=25^\circ C$, unless otherwise noted.

Parameter	Symbol	Conditions	Min	Typ	Max	Unit
Input Offset Voltage	V_{OS}			0.5	2.5	mV
Input Bias Current	I_B			1.0		pA
Input Offset Current	I_{OS}			1.0		pA
Input Common-mode Voltage Range	V_{CM}		-0.2		1.8	V
Common-mode Rejection Ratio	CMRR	$V_{CM}=-0.2V$ to $1.8V$	55	75		dB
Large Signal Voltage Gain	G_V	$R_L=10k\Omega$ to $V_{CC}/2$, $V_{OUT}=0.2V$ to $1.4V$	90	110		dB
Input Offset Voltage Drift	$\Delta V_{OS}/\Delta T$			2.0		$\mu V/^\circ C$
Output Voltage Swing from Rail	V_{OL}/V_{OH}	$R_L=1k\Omega$ to $V_{CC}/2$		30	50	mV
		$R_L=10k\Omega$ to $V_{CC}/2$		3	15	
Output Current	Sink	I_{SINK}	$V_{OUT}=V_{CC}$	8	10	mA
	Source	I_{SOURCE}	$V_{OUT}=0V$	5	8.5	
Closed-loop Output Impedance	Z_{OUT}	$f=10kHz$, $A_V=1$		9		Ω
Power Supply Rejection Ratio	PSRR	$V_{CC}=1.6V$ to $5.0V$	66	80		dB
Supply Current (Per Amplifier)	I_{CC}	$V_{OUT}=V_{CC}/2$, $I_{OUT}=0$		70	90	μA

1.6V AC Electrical Characteristics $V_{CC}=1.6V$, $V_{EE}=0$, $V_{OUT}=V_{CC}/2$, $V_{CM}=V_{CC}/2$, $T_A=25^\circ C$, unless otherwise noted.

Parameter	Symbol	Conditions	Min	Typ	Max	Unit
Gain Bandwidth Product	GBP	$R_L=100k\Omega$		1.0		MHz
Slew Rate (Note 2)	SR	1V Step, $C_L=100pF$, $R_L=10k\Omega$		0.32		V/ μs
Phase Margin	ϕ_M	$R_L=100k\Omega$		67		Degrees
Total Harmonic Distortion+Noise	THD+N	$f=1kHz$, $A_V=1$, $V_{IN}=1V_{pp}$ $R_L=10k\Omega$, $C_L=100pF$		-70		dB
Voltage Noise Density	e_n	$f=1kHz$		27		nV/\sqrt{Hz}

Note 2: Number specified is the positive slew rate.



**Single/Dual Low Bias Current, Low Voltage, Rail-to-Rail
Input/Output CMOS Operational Amplifiers**

AZV831/2

1.8V DC Electrical Characteristics

$V_{CC}=1.8V, V_{EE}=0, V_{OUT}=V_{CC}/2, V_{CM}=V_{CC}/2, T_A=25^{\circ}C$, unless otherwise noted.

Parameter	Symbol	Conditions	Min	Typ	Max	Unit
Input Offset Voltage	V_{OS}			0.5	2.5	mV
Input Bias Current	I_B			1.0		pA
Input Offset Current	I_{OS}			1.0		pA
Input Common-mode Voltage Range	V_{CM}		-0.2		2.0	V
Common-mode Rejection Ratio	CMRR	$V_{CM}=-0.2V$ to $2.0V$	55	75		dB
Large Signal Voltage Gain	G_V	$R_L=10k\Omega$ to $V_{CC}/2$, $V_{OUT}=0.2V$ to $1.6V$	90	112		dB
Input Offset Voltage Drift	$\Delta V_{OS}/\Delta T$			2.0		$\mu V/^{\circ}C$
Output Voltage Swing from Rail	V_{OL}/V_{OH}	$R_L=1k\Omega$ to $V_{CC}/2$		25	50	mV
		$R_L=10k\Omega$ to $V_{CC}/2$		3	15	
Output Current	Sink	I_{SINK}	$V_{OUT}=V_{CC}$	12	16	mA
	Source	I_{SOURCE}	$V_{OUT}=0V$	10	14	
Closed-loop Output Impedance	Z_{OUT}	$f=10kHz$		9		Ω
Power Supply Rejection Ratio	PSRR	$V_{CC}=1.6V$ to $5.0V$	66	80		dB
Supply Current (Per Amplifier)	I_{CC}	$V_{OUT}=V_{CC}/2, I_{OUT}=0$		70	90	μA

1.8V AC Electrical Characteristics

$V_{CC}=1.8V, V_{EE}=0, V_{OUT}=V_{CC}/2, V_{CM}=V_{CC}/2, T_A=25^{\circ}C$, unless otherwise noted.

Parameter	Symbol	Conditions	Min	Typ	Max	Unit
Gain Bandwidth Product	GBP	$R_L=100k\Omega$		1.0		MHz
Slew Rate (Note 2)	SR	1V Step, $C_L=100pF, R_L=10k\Omega$		0.34		$V/\mu s$
Phase Margin	ϕ_M	$R_L=100k\Omega$		67		Degrees
Total Harmonic Distortion+Noise	THD+N	$f=1kHz, A_V=1, V_{IN}=1V_{pp}$ $R_L=10k\Omega, C_L=100pF$		-70		dB
Voltage Noise Density	e_n	$f=1kHz$		27		nV/\sqrt{Hz}

Note 2: Number specified is the positive slew rate.



**Single/Dual Low Bias Current, Low Voltage, Rail-to-Rail
Input/Output CMOS Operational Amplifiers**

AZV831/2

3.0V DC Electrical Characteristics

$V_{CC}=3.0V, V_{EE}=0, V_{OUT}=V_{CC}/2, V_{CM}=V_{CC}/2, T_A=25^{\circ}C$, unless otherwise noted.

Parameter	Symbol	Conditions	Min	Typ	Max	Unit
Input Offset Voltage	V_{OS}			0.5	2.5	mV
Input Bias Current	I_B			1.0		pA
Input Offset Current	I_{OS}			1.0		pA
Input Common-mode Voltage Range	V_{CM}		-0.3		3.3	V
Common-mode Rejection Ratio	CMRR	$V_{CM}=-0.3V$ to 1.8V	62	80		dB
		$V_{CM}=-0.3V$ to 3.3V	58	75		
Large Signal Voltage Gain	G_V	$R_L=1k\Omega$ to $V_{CC}/2$, $V_{OUT}=0.2V$ to 2.8V	90	110		dB
		$R_L=10k\Omega$ to $V_{CC}/2$, $V_{OUT}=0.1V$ to 2.9V	95	115		
Input Offset Voltage Drift	$\Delta V_{OS}/\Delta T$			2.0		$\mu V/^{\circ}C$
Output Voltage Swing from Rail	V_{OL}/V_{OH}	$R_L=1k\Omega$ to $V_{CC}/2$		20	50	mV
		$R_L=10k\Omega$ to $V_{CC}/2$		3	15	
Output Current	Sink	I_{SINK}	$V_{OUT}=V_{CC}$	50	60	mA
	Source	I_{SOURCE}	$V_{OUT}=0V$	50	65	
Closed-loop Output Impedance	Z_{OUT}	$f=10kHz$		9		Ω
Power Supply Rejection Ratio	PSRR	$V_{CC}=1.6V$ to 5.0V	66	80		dB
Supply Current (Per Amplifier)	I_{CC}	$V_{OUT}=V_{CC}/2, I_{OUT}=0$		70	90	μA

3.0V AC Electrical Characteristics

$V_{CC}=3.0V, V_{EE}=0, V_{OUT}=V_{CC}/2, V_{CM}=V_{CC}/2, T_A=25^{\circ}C$, unless otherwise noted.

Parameter	Symbol	Conditions	Min	Typ	Max	Unit
Gain Bandwidth Product	GBP	$R_L=100k\Omega$		1.0		MHz
Slew Rate (Note 2)	SR	$G=1, 2V$ Step, $C_L=100pF, R_L=10k\Omega$		0.40		V/ μs
Phase Margin	ϕ_M	$R_L=100k\Omega$		67		Degrees
Total Harmonic Distortion+Noise	THD+N	$f=1kHz, G=1, V_{IN}=1V_{pp}$ $R_L=10k\Omega, C_L=100pF$		-70		dB
Voltage Noise Density	e_n	$f=1kHz$		27		nV/\sqrt{Hz}

Note 2: Number specified is the positive slew rate.



**Single/Dual Low Bias Current, Low Voltage, Rail-to-Rail
Input/Output CMOS Operational Amplifiers**

AZV831/2

5.0V DC Electrical Characteristics

$V_{CC}=5.0V$, $V_{EE}=0$, $V_{OUT}=V_{CC}/2$, $V_{CM}=V_{CC}/2$, $T_A=25^\circ C$, unless otherwise noted.

Parameter	Symbol	Conditions	Min	Typ	Max	Unit
Input Offset Voltage	V_{OS}			0.5	2.5	mV
Input Bias Current	I_B			1.0		pA
Input Offset Current	I_{OS}			1.0		pA
Input Common-mode Voltage Range	V_{CM}		-0.3		5.3	V
Common-mode Rejection Ratio	CMRR	$V_{CM}=-0.3V$ to $3.8V$	70	85		dB
		$V_{CM}=-0.3V$ to $5.3V$	65	90		
Large Signal Voltage Gain	G_V	$R_L=1k\Omega$ to $V_{CC}/2$, $V_{OUT}=0.2V$ to $4.8V$	80	92		dB
		$R_L=10k\Omega$ to $V_{CC}/2$, $V_{OUT}=0.05V$ to $4.95V$	85	98		
Input Offset Voltage Drift	$\Delta V_{OS}/\Delta T$			2.0		$\mu V/^\circ C$
Output Voltage Swing from Rail	V_{OL}/V_{OH}	$R_L=1k\Omega$ to $V_{CC}/2$		25	50	mV
		$R_L=10k\Omega$ to $V_{CC}/2$		4	15	
Output Current	Sink	I_{SINK}	$V_{OUT}=V_{CC}$	100	150	mA
	Source	I_{SOURCE}	$V_{OUT}=0V$	110	185	
Closed-loop Output Impedance		$f=1kHz$, $A_V=1$		9		Ω
Power Supply Rejection Ratio	PSRR	$V_{CC}=1.6V$ to $5.0V$	66	80		dB
Supply Current (Per Amplifier)	I_{CC}	$V_{OUT}=V_{CC}/2$, $I_{OUT}=0$		70	90	μA

5V AC Electrical Characteristics

$V_{CC}=5.0V$, $V_{EE}=0$, $V_{OUT}=V_{CC}/2$, $V_{CM}=V_{CC}/2$, $T_A=25^\circ C$, unless otherwise noted.

Parameter	Symbol	Conditions	Min	Typ	Max	Unit
Gain Bandwidth Product	GBP	$R_L=100k\Omega$		1.0		MHz
Slew Rate (Note 2)	SR	2V Step, $C_L=100pF$, $R_L=10k\Omega$		0.45		$V/\mu s$
Phase Margin	ϕ_M	$R_L=100k\Omega$		67		Degrees
THD+N	THD+N	$f=1kHz$, $A_V=1$, $V_{IN}=1V_{PP}$ $R_L=10k\Omega$, $C_L=100pF$		-70		dB
Voltage Noise Density	e_n	$f=1kHz$		27		nV/\sqrt{Hz}

Note 2: Number specified is the positive slew rate.



**Single/Dual Low Bias Current, Low Voltage, Rail-to-Rail
Input/Output CMOS Operational Amplifiers**

AZV831/2

Typical Performance Characteristics

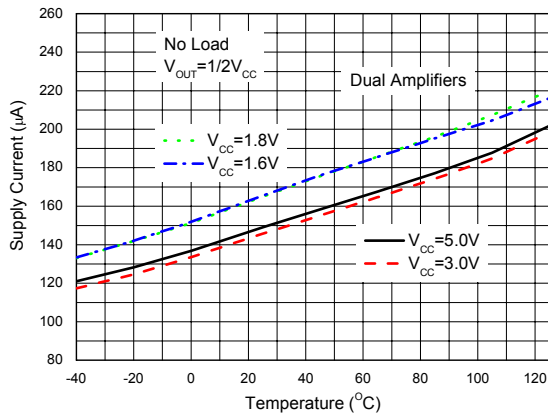

Figure 4. Supply Current vs. Temperature

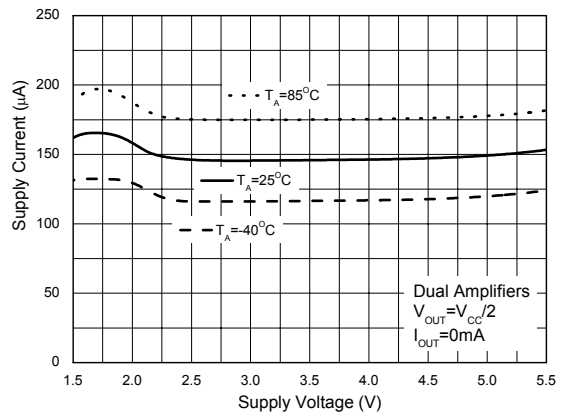

Figure 5. Supply Current vs. Supply Voltage

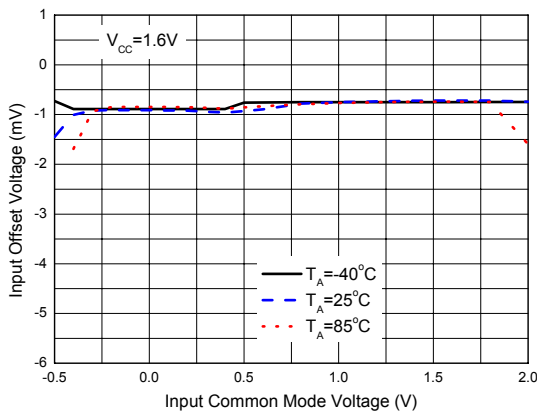

Figure 6. Input Offset Voltage vs. Input Common Mode Voltage

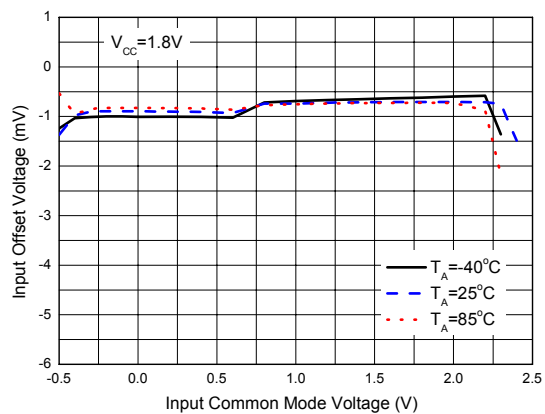

Figure 7. Input Offset Voltage vs. Input Common Mode Voltage

**Single/Dual Low Bias Current, Low Voltage, Rail-to-Rail
Input/Output CMOS Operational Amplifiers**

AZV831/2

Typical Performance Characteristics (Continued)

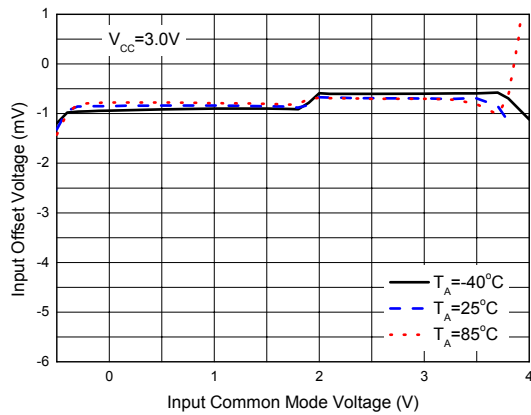

Figure 8. Input Offset Voltage vs. Input Common Mode Voltage

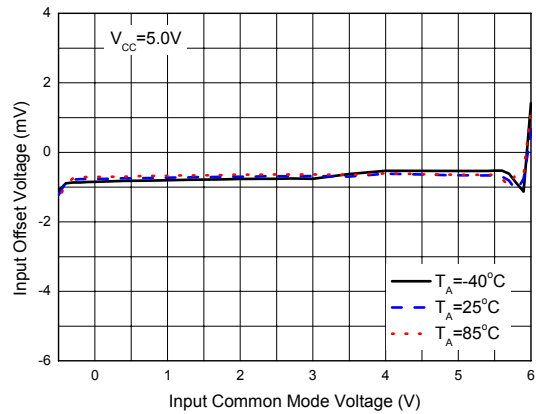

Figure 9. Input Offset Voltage vs. Input Common Mode Voltage

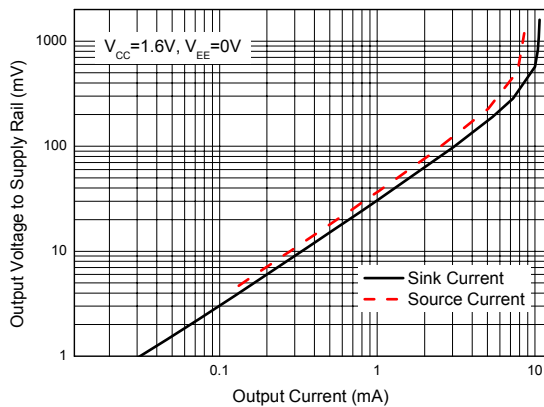

Figure 10. Output Voltage vs. Output Current

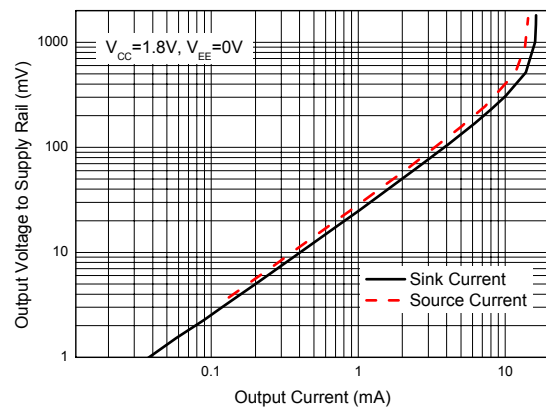

Figure 11. Output Voltage vs. Output Current



**Single/Dual Low Bias Current, Low Voltage, Rail-to-Rail
Input/Output CMOS Operational Amplifiers**

AZV831/2

Typical Performance Characteristics (Continued)

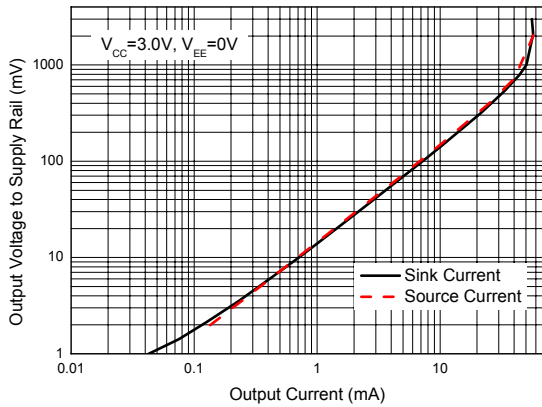

Figure 12. Output Voltage vs. Output Current

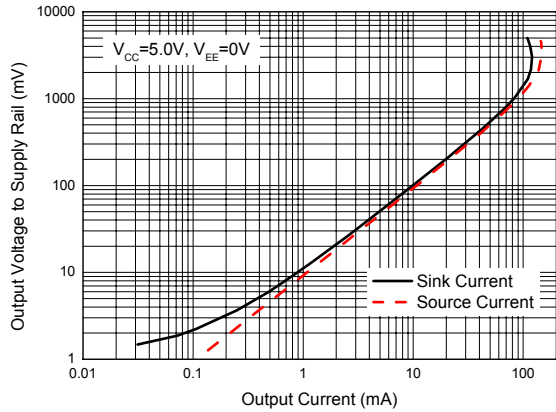

Figure 13. Output Voltage vs. Output Current

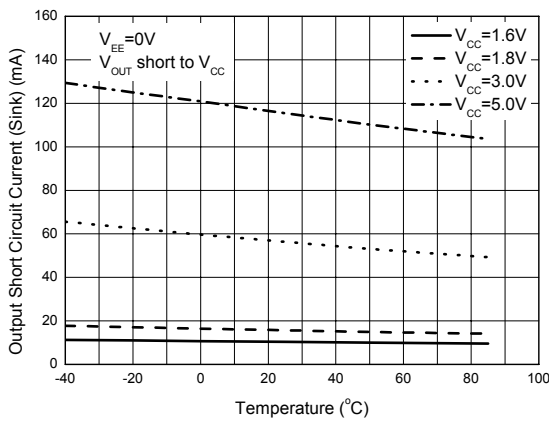

Figure 14. Output Short Circuit Current vs. Temperature

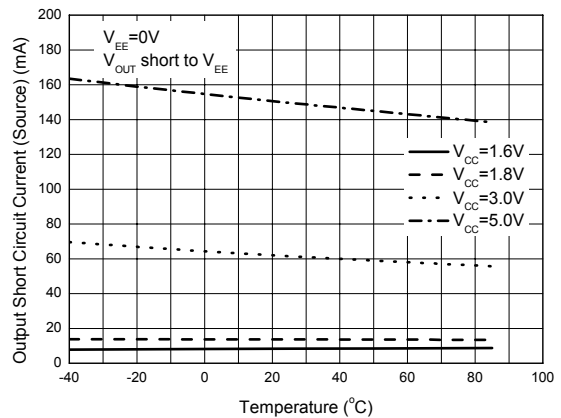

Figure 15. Output Short Circuit Current vs. Temperature

**Single/Dual Low Bias Current, Low Voltage, Rail-to-Rail
Input/Output CMOS Operational Amplifiers**

AZV831/2

Typical Performance Characteristics (Continued)

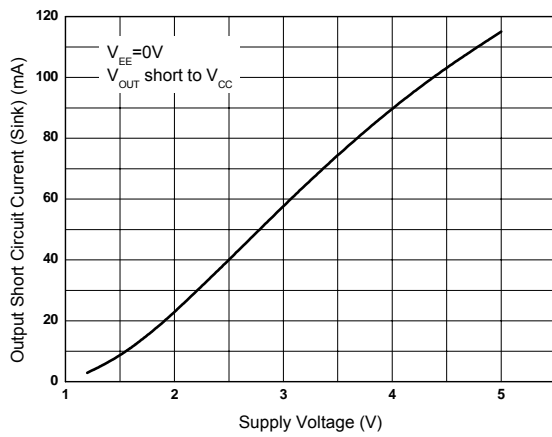

Figure 16. Output Short Circuit Current vs. Supply Voltage

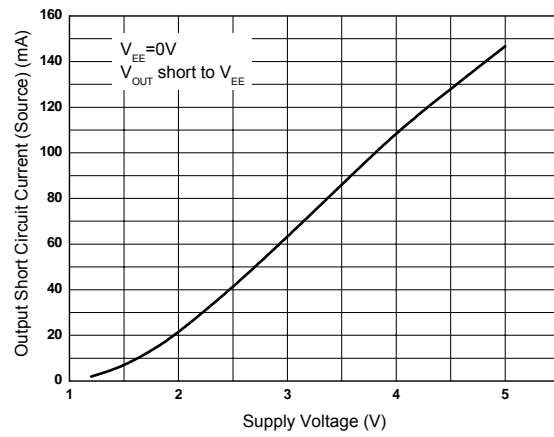

Figure 17. Output Short Circuit Current vs. Supply Voltage

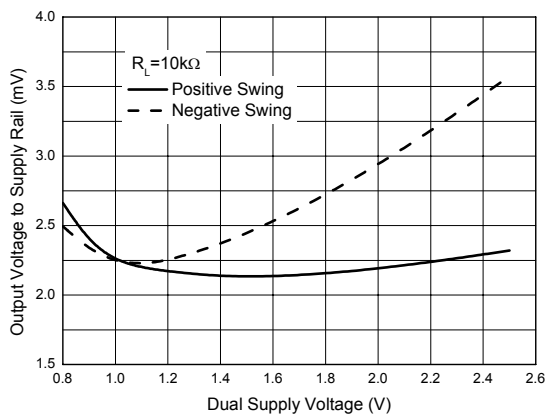

Figure 18. Output Voltage Swing vs. Supply Voltage

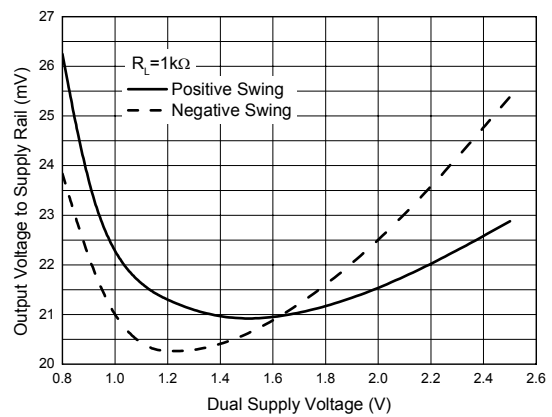

Figure 19. Output Voltage Swing vs. Supply Voltage

**Single/Dual Low Bias Current, Low Voltage, Rail-to-Rail
Input/Output CMOS Operational Amplifiers**

AZV831/2

Typical Performance Characteristics (Continued)

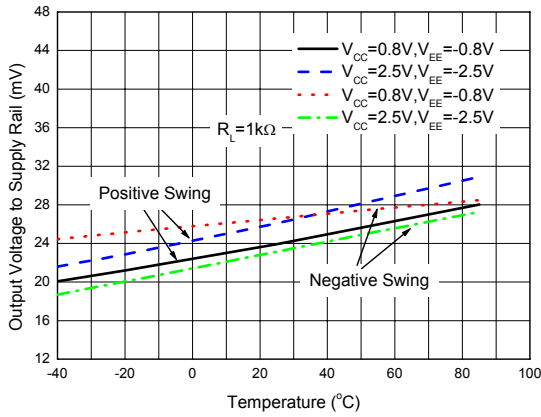

Figure 20. Output Voltage Swing vs. Temperature

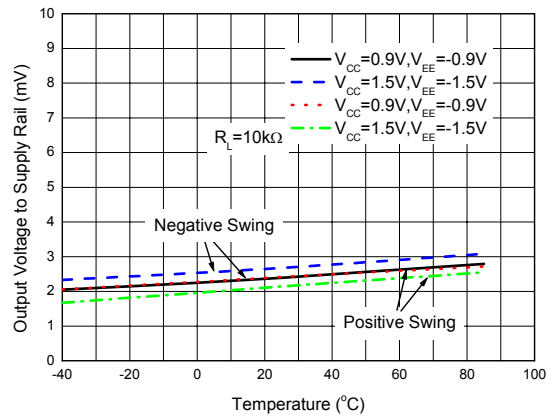

Figure 21. Output Voltage Swing vs. Temperature

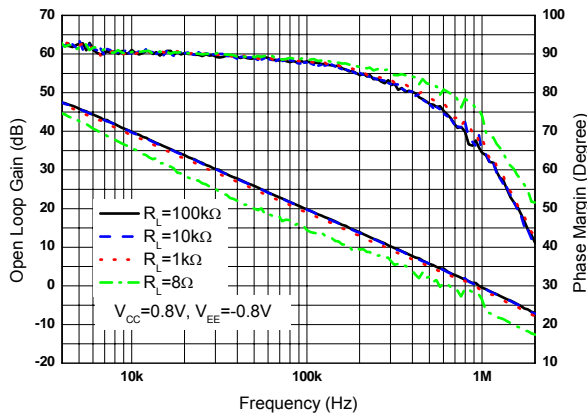

Figure 22. Gain and Phase vs. Frequency with Resistive Load

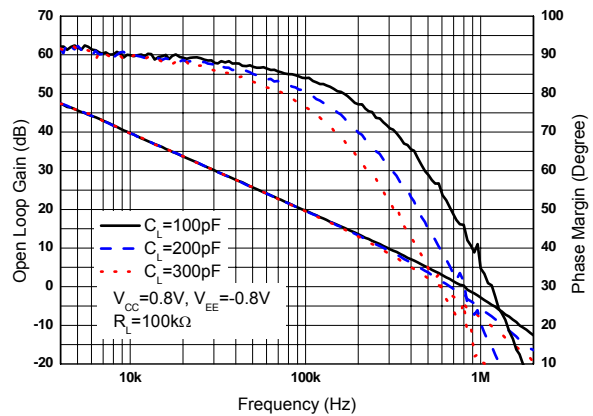

Figure 23. Gain and Phase vs. Frequency with Capacitive Load



Single/Dual Low Bias Current, Low Voltage, Rail-to-Rail
Input/Output CMOS Operational Amplifiers

AZV831/2

Typical Performance Characteristics (Continued)

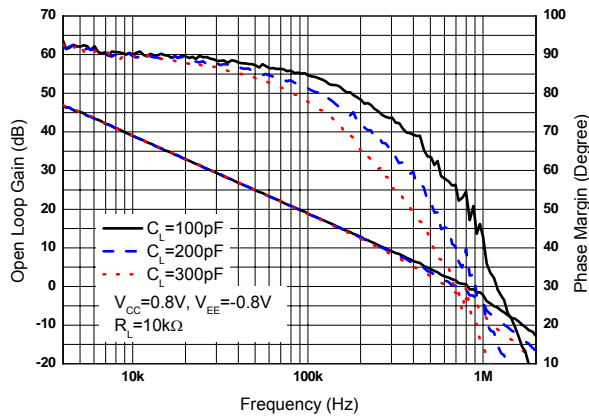

Figure 24. Gain and Phase vs. Frequency with Capacitive Load

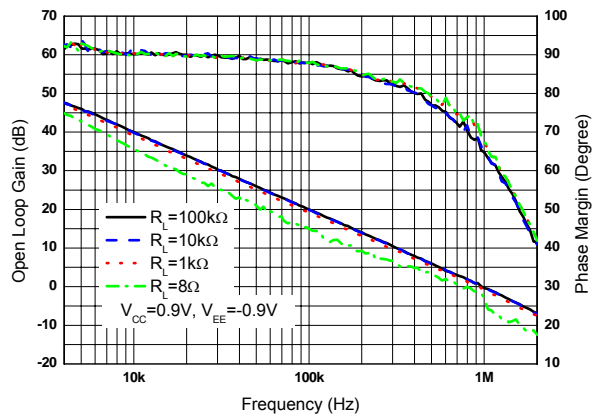

Figure 25. Gain and Phase vs. Frequency with Resistive Load

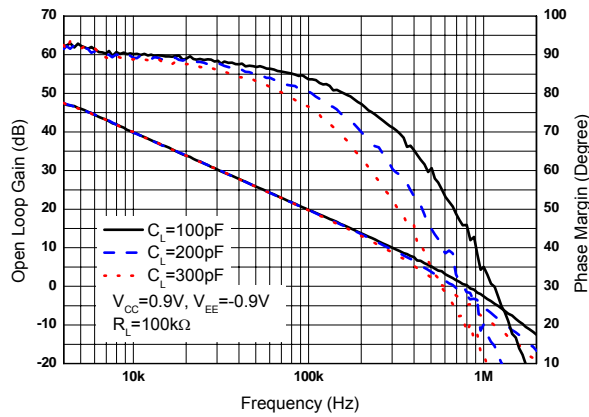

Figure 26. Gain and Phase vs. Frequency with Capacitive Load

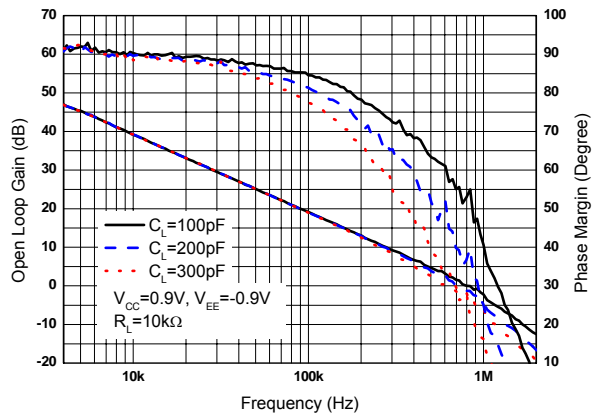

Figure 27. Gain and Phase vs. Frequency with Capacitive Load

**Single/Dual Low Bias Current, Low Voltage, Rail-to-Rail
Input/Output CMOS Operational Amplifiers**

AZV831/2

Typical Performance Characteristics (Continued)

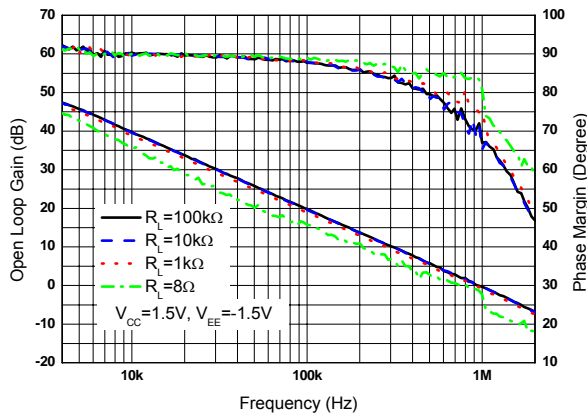

Figure 28. Gain and Phase vs. Frequency with Resistive Load

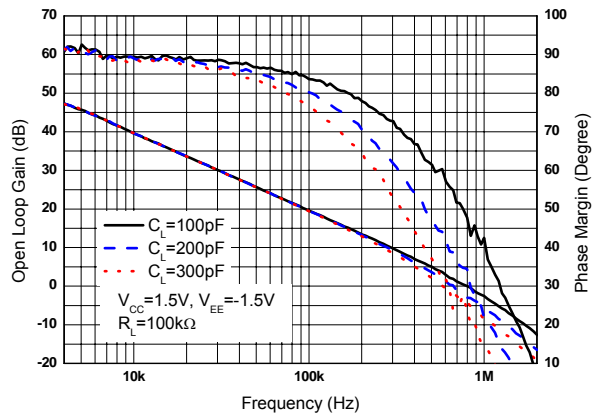

Figure 29. Gain and Phase vs. Frequency with Capacitive Load

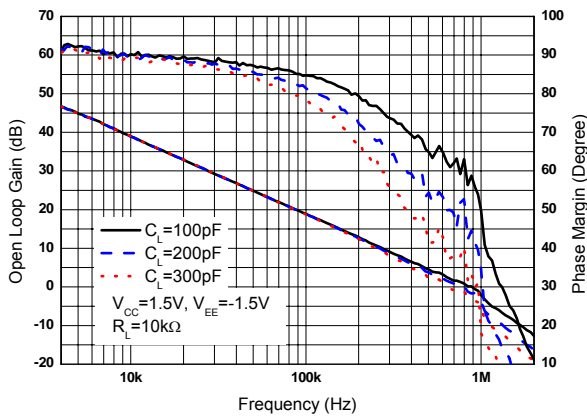

Figure 30. Gain and Phase vs. Frequency with Capacitive Load

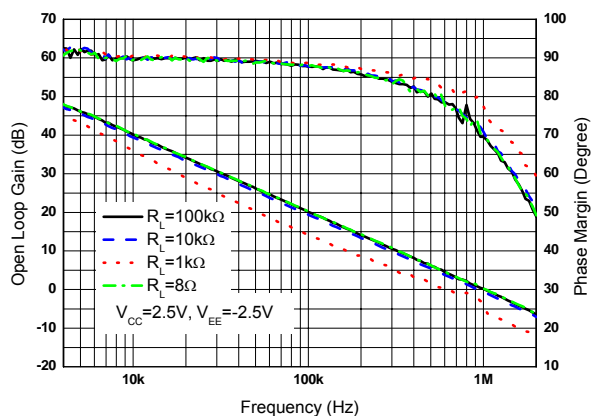

Figure 31. Gain and Phase vs. Frequency with Resistive Load



Single/Dual Low Bias Current, Low Voltage, Rail-to-Rail
Input/Output CMOS Operational Amplifiers

AZV831/2

Typical Performance Characteristics (Continued)

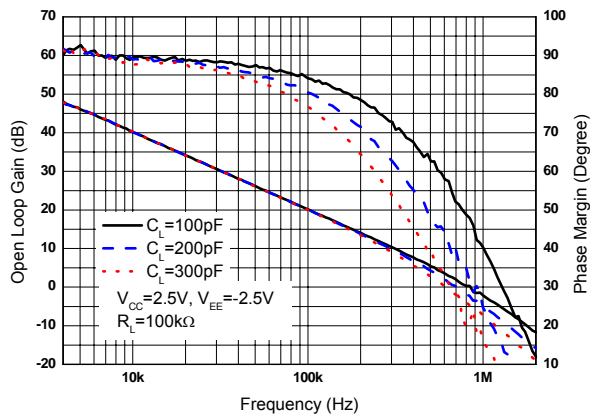

Figure 32. Gain and Phase vs. Frequency with Capacitive Load

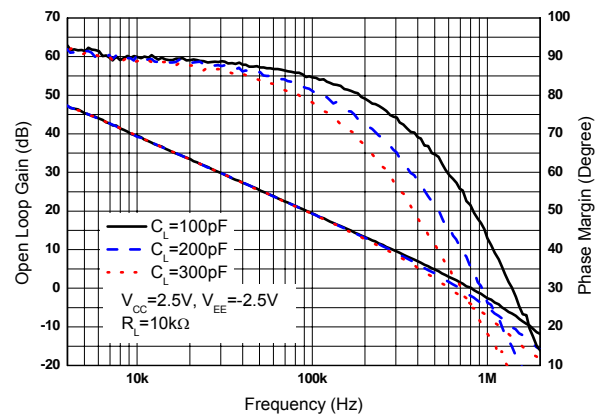

Figure 33. Gain and Phase vs. Frequency with Capacitive Load

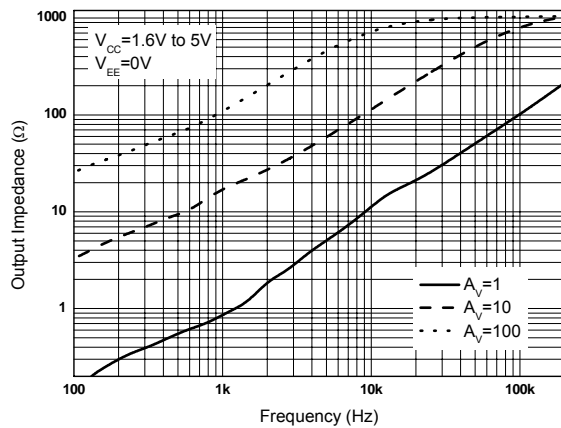

Figure 34. Output Impedance vs. Frequency

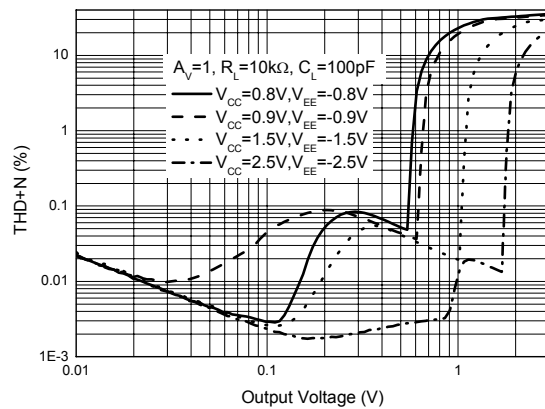

Figure 35. THD+N vs. Output Voltage

**Single/Dual Low Bias Current, Low Voltage, Rail-to-Rail
Input/Output CMOS Operational Amplifiers**

AZV831/2

Typical Performance Characteristics (Continued)

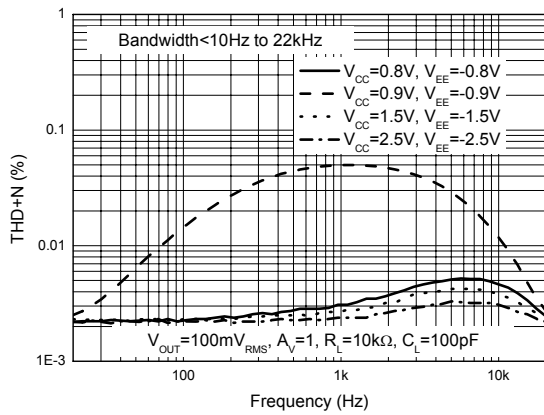

Figure 36. THD+N vs. Frequency

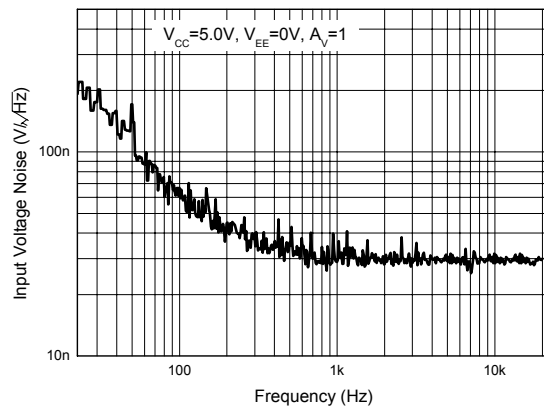
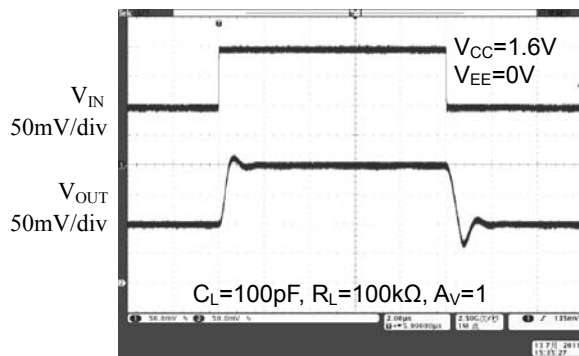
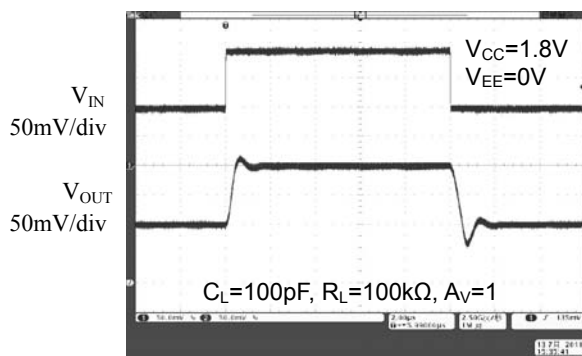

Figure 37. Input Voltage Noise Density



Time (2 μ s/div)

Figure 38. Small Signal Pulse Response



Time (2 μ s/div)

Figure 39. Small Signal Pulse Response

**Single/Dual Low Bias Current, Low Voltage, Rail-to-Rail
Input/Output CMOS Operational Amplifiers**
AZV831/2
Typical Performance Characteristics (Continued)

 Time (2 μ s/div)

Figure 40. Small Signal Pulse Response

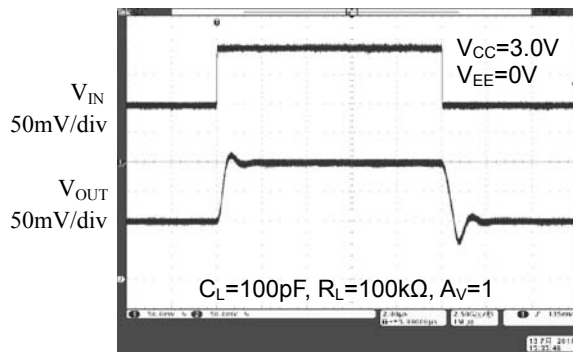

 Time (2 μ s/div)

Figure 41. Small Signal Pulse Response

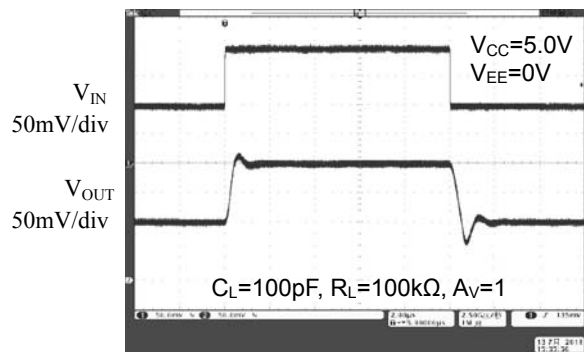

 Time (10 μ s/div)

Figure 42. Large Signal Pulse Response

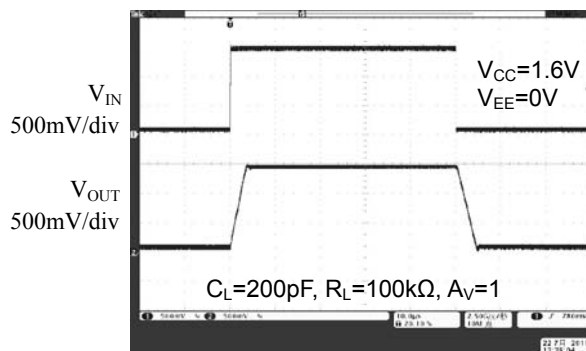

 Time (10 μ s/div)

Figure 43. Large Signal Pulse Response

**Single/Dual Low Bias Current, Low Voltage, Rail-to-Rail
Input/Output CMOS Operational Amplifiers**

AZV831/2

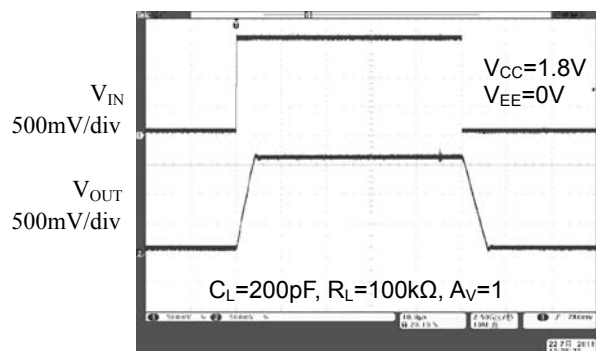
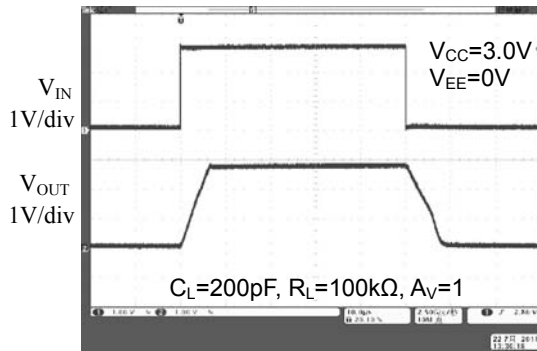
Typical Performance Characteristics (Continued)



Time (10μs/div)

Figure 44. Large Signal Pulse Response

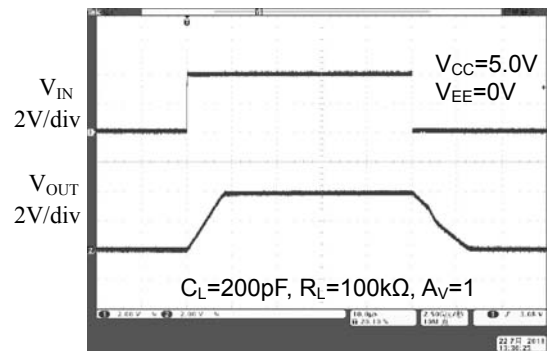

Time (10μs/div)

Figure 45. Large Signal Pulse Response

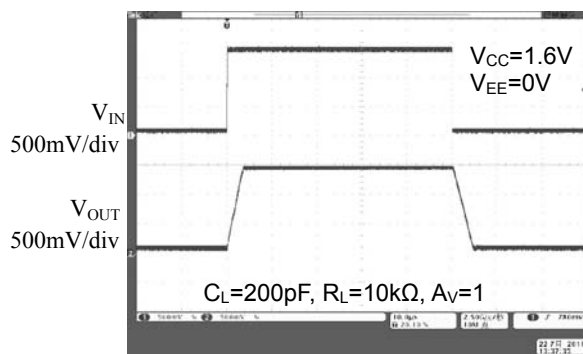

Time (10μs/div)

Figure 46. Large Signal Pulse Response

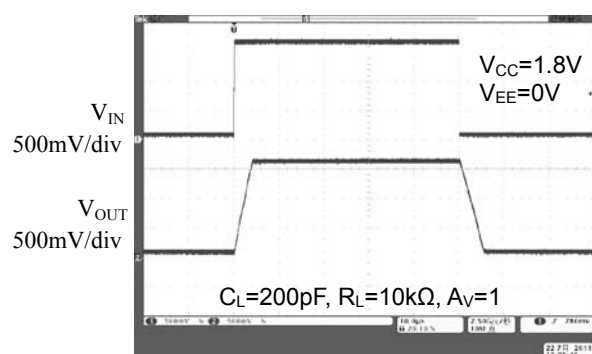

Time (10μs/div)

Figure 47. Large Signal Pulse Response

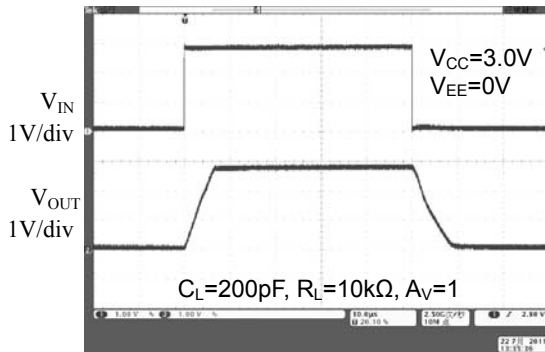
**Single/Dual Low Bias Current, Low Voltage, Rail-to-Rail
Input/Output CMOS Operational Amplifiers**
AZV831/2
Typical Performance Characteristics (Continued)

Time (10µs/div)

Figure 48. Large Signal Pulse Response

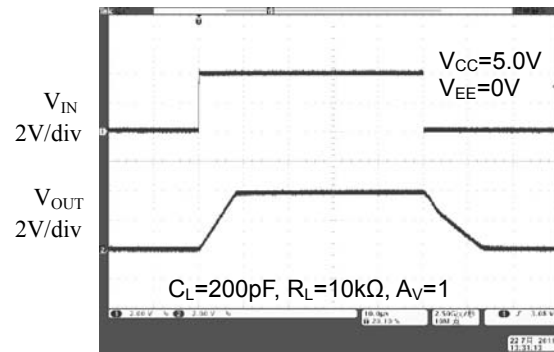

Time (10µs/div)

Figure 49. Large Signal Pulse Response

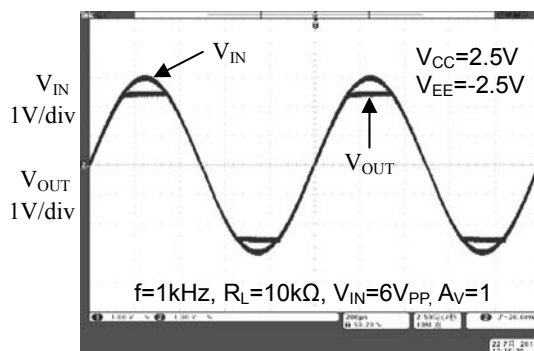

Time (200µs/div)

Figure 50. No Phase Reversal

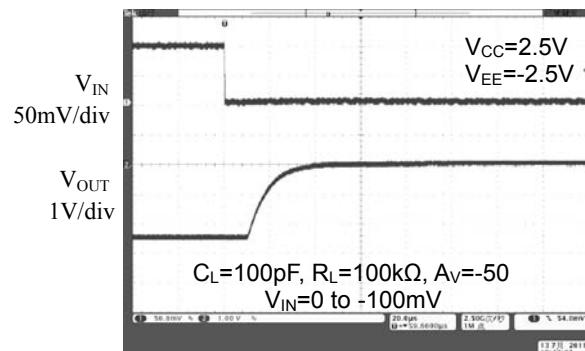

Time (20µs/div)

Figure 51. Overload Recovery Time

**Single/Dual Low Bias Current, Low Voltage, Rail-to-Rail
Input/Output CMOS Operational Amplifiers****AZV831/2****Typical Performance Characteristics (Continued)**

Figure 52. Overload Recovery Time

**Single/Dual Low Bias Current, Low Voltage, Rail-to-Rail
Input/Output CMOS Operational Amplifiers**

AZV831/2

Mechanical Dimensions

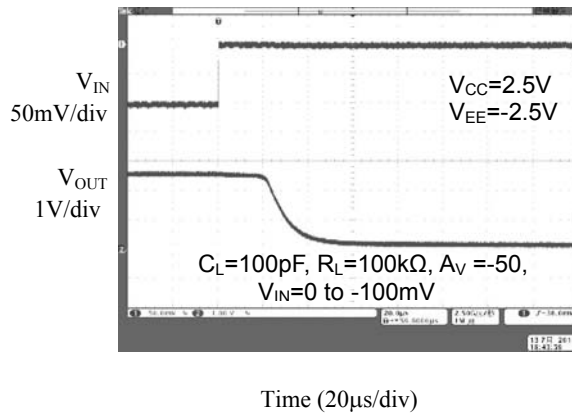
SC-70-5

Unit: mm(inch)

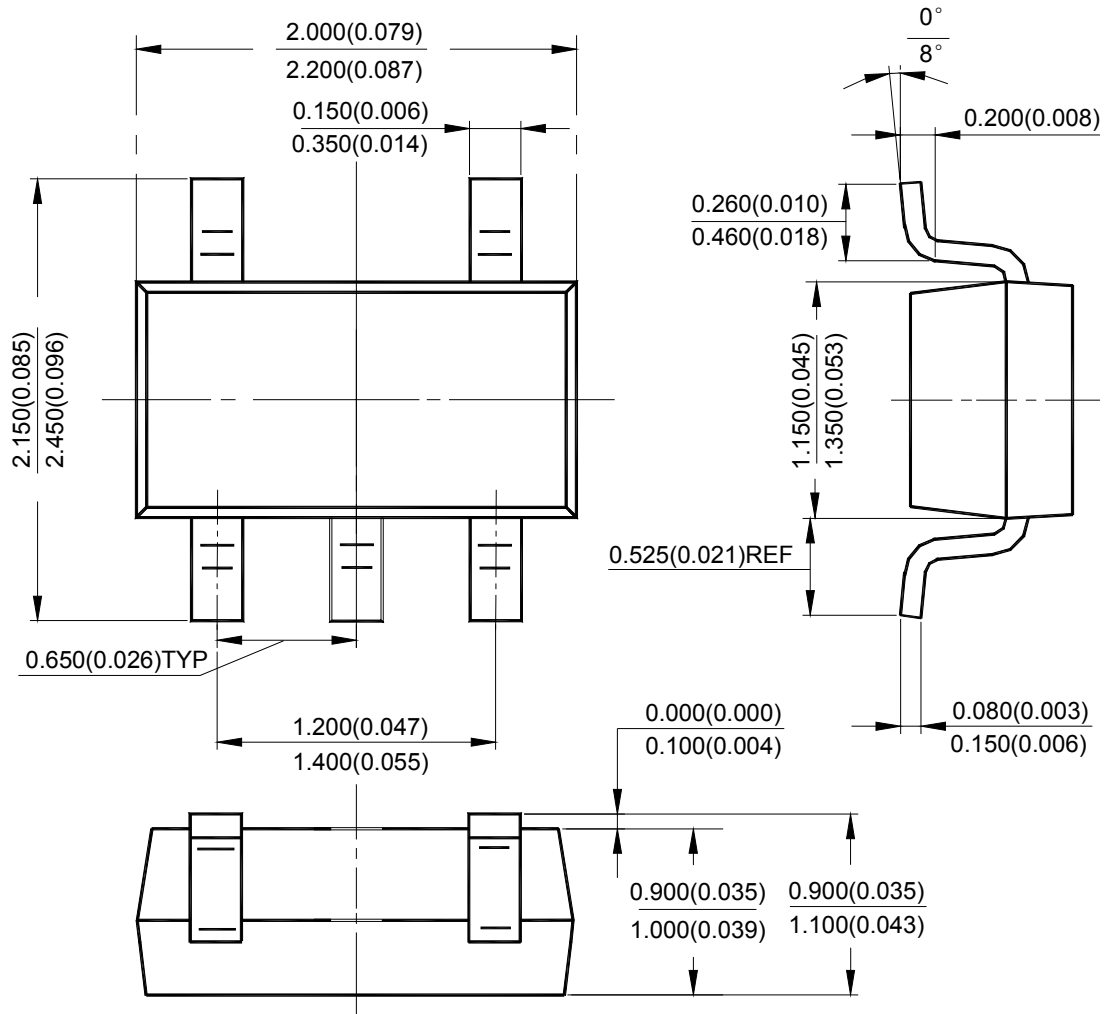



**Single/Dual Low Bias Current, Low Voltage, Rail-to-Rail
Input/Output CMOS Operational Amplifiers**

AZV831/2

Mechanical Dimensions (Continued)

SOT-23-5

Unit: mm(inch)

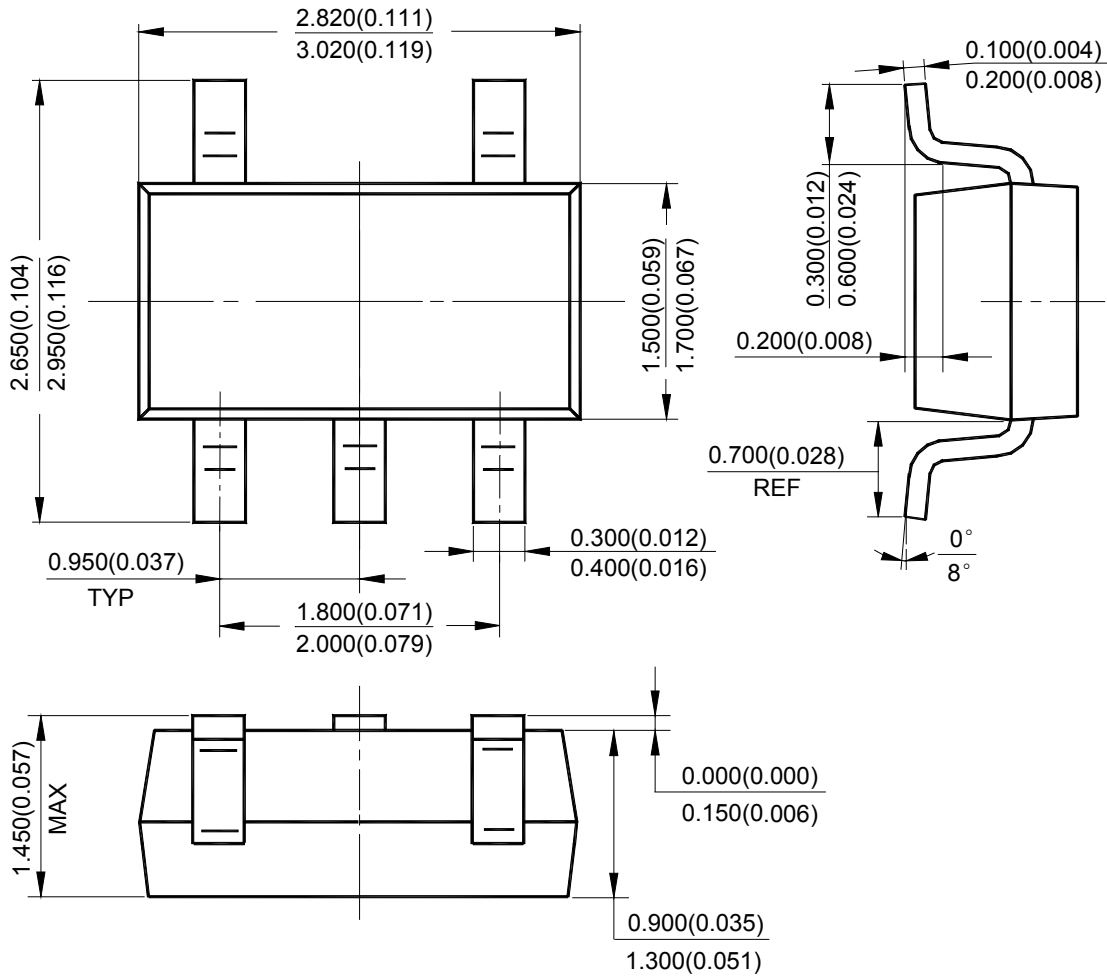

**Single/Dual Low Bias Current, Low Voltage, Rail-to-Rail
Input/Output CMOS Operational Amplifiers**

AZV831/2

Mechanical Dimensions (Continued)

SOIC-8

Unit: mm(inch)

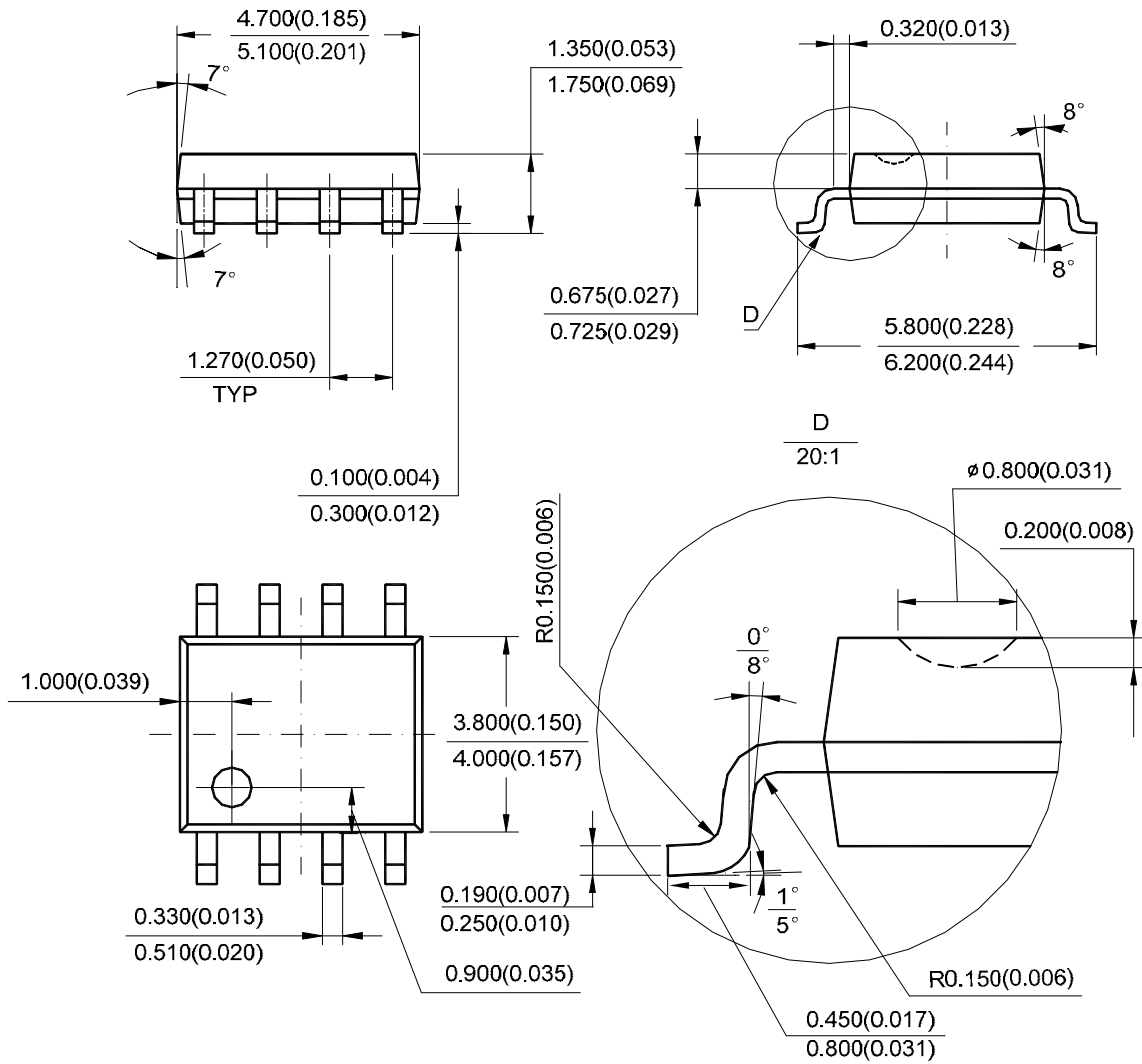

Note: Eject hole, oriented hole and mold mark is optional.

**Single/Dual Low Bias Current, Low Voltage, Rail-to-Rail
Input/Output CMOS Operational Amplifiers**

AZV831/2

Mechanical Dimensions (Continued)

MSOP-8

Unit: mm(inch)

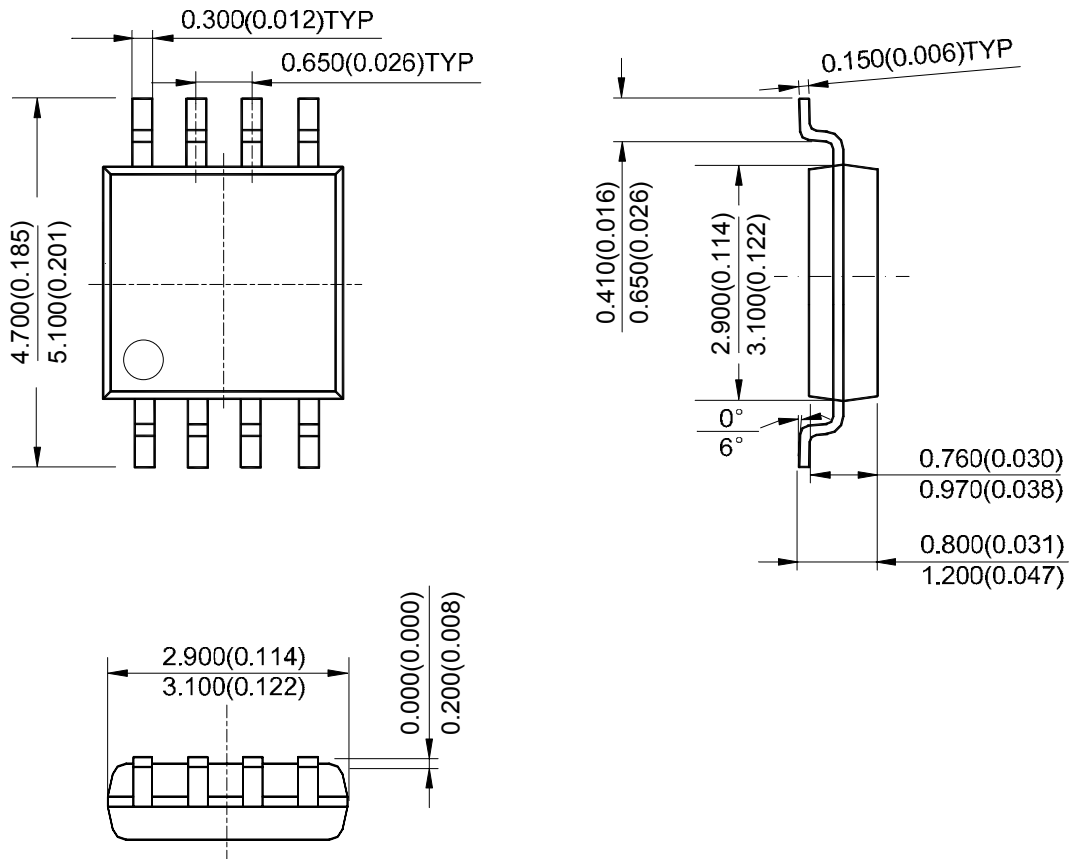

Note: Eject hole, oriented hole and mold mark is optional.



BCD Semiconductor Manufacturing Limited

<http://www.bcdsemi.com>

IMPORTANT NOTICE

BCD Semiconductor Manufacturing Limited reserves the right to make changes without further notice to any products or specifications herein. BCD Semiconductor Manufacturing Limited does not assume any responsibility for use of any its products for any particular purpose, nor does BCD Semiconductor Manufacturing Limited assume any liability arising out of the application or use of any its products or circuits. BCD Semiconductor Manufacturing Limited does not convey any license under its patent rights or other rights nor the rights of others.

MAIN SITE

- Headquarters

BCD Semiconductor Manufacturing Limited

No. 1600, Zi Xing Road, Shanghai ZiZhu Science-based Industrial Park, 200241, China
Tel: +86-21-24162266, Fax: +86-21-24162277

- Wafer Fab

Shanghai SIM-BCD Semiconductor Manufacturing Co., Ltd.

800 Yi Shan Road, Shanghai 200233, China
Tel: +86-21-6485 1491, Fax: +86-21-5450 0008

REGIONAL SALES OFFICE

Shenzhen Office

Shanghai SIM-BCD Semiconductor Manufacturing Co., Ltd., Shenzhen Office

Unit A Room 1203, Skyworth Bldg., Gaoxin Ave. 1.S., Nanshan District, Shenzhen, China
Tel: +86-755-8826 7951
Fax: +86-755-8826 7865

Taiwan Office

BCD Semiconductor (Taiwan) Company Limited

4F, 298-1, Rui Guang Road, Nei-Hu District, Taipei, Taiwan
Tel: +886-2-2656 2808
Fax: +886-2-2656 2806

USA Office

BCD Semiconductor Corp.

30920 Huntwood Ave. Hayward, CA 94544, USA
Tel : +1-510-324-2988
Fax: +1-510-324-2788

Компания «Океан Электроники» предлагает заключение долгосрочных отношений при поставках импортных электронных компонентов на взаимовыгодных условиях!

Наши преимущества:

- Поставка оригинальных импортных электронных компонентов напрямую с производств Америки, Европы и Азии, а так же с крупнейших складов мира;
- Широкая линейка поставок активных и пассивных импортных электронных компонентов (более 30 млн. наименований);
- Поставка сложных, дефицитных, либо снятых с производства позиций;
- Оперативные сроки поставки под заказ (от 5 рабочих дней);
- Экспресс доставка в любую точку России;
- Помощь Конструкторского Отдела и консультации квалифицированных инженеров;
- Техническая поддержка проекта, помощь в подборе аналогов, поставка прототипов;
- Поставка электронных компонентов под контролем ВП;
- Система менеджмента качества сертифицирована по Международному стандарту ISO 9001;
- При необходимости вся продукция военного и аэрокосмического назначения проходит испытания и сертификацию в лаборатории (по согласованию с заказчиком);
- Поставка специализированных компонентов военного и аэрокосмического уровня качества (Xilinx, Altera, Analog Devices, Intersil, Interpoint, Microsemi, Actel, Aeroflex, Peregrine, VPT, Syfer, Eurofarad, Texas Instruments, MS Kennedy, Miteq, Cobham, E2V, MA-COM, Hittite, Mini-Circuits, General Dynamics и др.);

Компания «Океан Электроники» является официальным дистрибьютором и эксклюзивным представителем в России одного из крупнейших производителей разъемов военного и аэрокосмического назначения «JONHON», а так же официальным дистрибьютором и эксклюзивным представителем в России производителя высокотехнологичных и надежных решений для передачи СВЧ сигналов «FORSTAR».



JONHON

«JONHON» (основан в 1970 г.)

Разъемы специального, военного и аэрокосмического назначения:

(Применяются в военной, авиационной, аэрокосмической, морской, железнодорожной, горно- и нефтедобывающей отраслях промышленности)

«FORSTAR» (основан в 1998 г.)

ВЧ соединители, коаксиальные кабели, кабельные сборки и микроволновые компоненты:

(Применяются в телекоммуникациях гражданского и специального назначения, в средствах связи, РЛС, а так же военной, авиационной и аэрокосмической отраслях промышленности).



Телефон: 8 (812) 309-75-97 (многоканальный)

Факс: 8 (812) 320-03-32

Электронная почта: ocean@oceanchips.ru

Web: <http://oceanchips.ru/>

Адрес: 198099, г. Санкт-Петербург, ул. Калинина, д. 2, корп. 4, лит. А