

**Note:** All part numbers  
are RoHS Compliant.

---

**Engineering Notes**

---



**Note:** All part numbers are RoHS Compliant.

## Table of Contents—Barrier Strips

Overview .....	114-118
(Barrier Strip Selector Chart) .....	114, 115
<b>Tri-Barrier Strips</b> .....	119-138
0.250" Pitch .....	120-123
0.325" Pitch .....	124-127
0.375" Pitch .....	128-135
0.4375" Pitch .....	136-138
<b>Dual-Barrier Strips</b> .....	139-160
0.250" Pitch .....	141-142
0.325" Pitch .....	143-146
0.375" Pitch .....	147-150
0.4375" Pitch .....	151-154
0.375" Double Row, Panel Mount .....	155-156
0.433" Double Row, Panel Mount .....	157
0.437" Double Row, Panel Mount .....	158
0.563" Double Row, Panel Mount .....	160
<b>Sockets and Barrier Strips</b> .....	161-173
0.325" Pitch, Series USB3 Socket .....	162
0.375" Pitch, Series RSB6B Socket .....	163
0.325" Pitch, Series RSB3 Tri-Barrier .....	164-166
0.325" Pitch, Series SSB3 Dual-Barrier .....	168-170
0.375" Pitch, Series RSB6 Tri-Barrier .....	171-173
<b>Accessories</b> .....	174-179

**Note:** All part numbers are RoHS Compliant.

## Barrier Strip Selector Chart

### Tri-Barrier

	0.250"	0.325"	0.325"	0.375"	0.375"	0.375"	0.375"	0.4375"
<b>Series</b>	#3	#4	1546927	#6	1546833	BC6	MB6	#8
<b>Pitch (in)</b>	0.250"	0.325"	0.325"	0.375"	0.375"	0.375"	0.375"	0.4375"
<b>Circuits</b>	2-32	2-30	2-8	2-30	2-8	2-16	4-40	2-26
<b>Max Current</b>	10A	25A	15A	25A	15A	20A	25A	30A
<b>Max Voltage</b>	300V	300V	300V	600V	300V	300V	300V	600V
<b>Wire Range (AWG)</b>	18-22	12-22	14-22	12-22	14-22	12-22	12-22	10-18
<b>Description</b>	Molded to length	Molded to length	Molded to length	Molded to length	Molded to length, Modular	Molded to length	Double Level snapped to length	Molded to length
<b>Page</b>	120-123	124-126	127	128-131	132	133-134	135	136-138

### Dual-Barrier

	.250"	0.325"	0.325"	0.375"	0.375"	0.4375"
<b>Series</b>	1546657	4DB	1546734	JC6	NC6	SSB7
<b>Pitch (in)</b>	.250"	0.325"	0.325"	0.375"	0.375"	0.4375"
<b>Circuits</b>	2-30	2-30	2-16	2-16	2-30	2-27
<b>Max Current</b>	10A	20A	20A	20A	20A	20A
<b>Max Voltage</b>	300V	150V/ 300V	300V	300V	300V	600V
<b>Wire Range (AWG)</b>	16-30	14-22	12-22	12-22	12-22	12-26
<b>Description</b>	Molded to length	Molded to length	High Rise, Molded to length	Molded to length	Low Profile version, Molded to length	Cut to length
<b>Page</b>	141-142	143-144	145-146	147-148	149-150	151-154

**Note:** All part numbers are RoHS Compliant.

**Barrier Strip Selector Chart** (Continued)

**Double Row**

	0.374"	0.433"	0.437"	0.563"	
<b>Series</b>	1546306 1546307	1546481 1546477	1546670 1546671	1546310 1546311	1776544 1986158
<b>Pitch (in)</b>	0.374"	0.433"	0.437"	0.563"	0.563"
<b>Circuits</b>	2-30	2-26	2-26	2-18	2-18
<b>Max Current</b>	20A	25A	25A	30A	30A
<b>Max Voltage</b>	300V	300V	300V	300V	600V
<b>Wire Range (AWG)</b>	12-22	14-22	14-22	10-22	10-22
<b>Description</b>	Panel Mount, molded to length	Panel Mount, molded to length	Panel Mount, molded to length	Panel Mount, molded to length	Panel Mount, molded to length
<b>Page</b>	156	157	158	159	160

**Sockets and Barrier Strips**



	0.325"	0.325"	0.325"	0.375"	0.375"
<b>Series</b>	USB	RSB3	SSB3	RSB6B	RSB6
<b>Pitch (in)</b>	0.325"	0.325"	0.325"	0.375"	0.375"
<b>Circuits</b>	2-12	2-36	2-36	2-10	2-36
<b>Max Current</b>	10A	15A	15A	10A	20A
<b>Max Voltage</b>	300V	300V	300V	300V	300V
<b>Wire Range (AWG)</b>	n/a	14-26	14-26	n/a	12-26
<b>Description</b>	For Series RSB3 & SSB3	Cut to length	Cut to length	For Series RSB6	Cut to length
<b>Page</b>	162	164-166	168-170	163	171-173

**Catalog Number Code**



**OPTIONAL TERMINAL IDENTIFICATION**

Select the desired version from the list below and add the CODE NUMBER (11, 12, 15 or 16) to the end of the catalog number of the connector or header.

- CODE  
11 = 1 2 3 4 . . .  
12 = . . . 4 3 2 1  
15 = . . . † 3 5 †  
16 = † 5 3 † . . .

*"First Number In Series" Designator\**

- |       |       |
|-------|-------|
| A = 1 | F = 6 |
| B = 2 | G = 7 |
| C = 3 | H = 8 |
| D = 4 | J = 9 |
| E = 5 | K = 0 |

\* Letters in this position designate the first number to be used in the consecutive sequence. Ex.: "A" would start the sequence with the number 1. "EK" would start the sequence with the number 50. "BKK" would start the series with 200. For non-sequential numbering and special characters, consult Technical Support.

**Note:** Some catalog number combinations are not valid. Check appropriate catalog pages before ordering. Catalog numbering code applies only to the catalog numbers on pages 125, 148-151, 164-169.

**Note:** All part numbers are RoHS Compliant.

**Catalog Number Code** (Continued)

# 6 PCV-04-XXX

**Contact Spacing**

- 3 = 0.250"
- 4 = 0.325"
- 6 = 0.375"
- 8 = 0.4375"

Suffix (if applicable)

Number of Circuits  
02 through XX

**Terminal Style**

- DBL** = Double Printed Circuit Pin
- PCR** = Printed Circuit, Right Angle
- PCV** = Printed Circuit Pin, Vertical
- QCR** = Quick Connect Tab, Right Angle
- QCV** = Quick Connect Tab, Vertical
- STR** = Solder Turret, Right Angle
- STV** = Solder Turret, Vertical
- TBV** = Non Feed Thru
- WWR** = Solderless Wire Wrap, Right Angle
- WWV** = Solderless Wire Wrap, Vertical

**Note:** Some catalog number combinations are not valid. Check appropriate catalog pages before ordering. Catalog numbering code applies only to the catalog numbers on pages 119-124, 127-129, 134-136.

## Barrier Strips – Overview

### Two Types of Barrier Strips and a Line of Sockets:

#### Tri-Barrier

Three walls or barriers surround each terminal screw. The back wall safeguards field wiring.



#### Dual-Barrier

Two walls or barriers are molded on each side of the terminal screw.



#### Sockets

Mounted directly to the PC board, the Barrier Strip is plugged into the socket. The socket expedites field maintenance. (Below, a tri-barrier is about to be mounted in a socket.)



#### Wire Clamp Screws

The lower surface and edges of the clamping-plates are carefully designed to securely clamp the wire—even combinations of different wire sizes—without severing stranded wire. Extra care has been taken to produce these components without burrs on any critical clamping surface or edges.

#### Resilient Plastic Barriers

Flexible thermoplastic material for terminal blocks was an especially important feature at the time of its introduction, since many earlier blocks were molded of more rigid, brittle thermosetting plastic compounds.

#### Wire-Ready Raised Screws

Wire-ready raised screws are standard on BUCHANAN terminal blocks. No need to back off the screw first. Just insert the wire and drive down the screw. Wire installation time and effort are virtually cut in half.

#### Integral Standoffs

Standoffs help rid your PCB of any remaining corrosive agents during rinsing operations. Helps prevent trapped solutions in the immediate PC pin area. Significantly reduces the risk of postwave corrosion problems.

#### Gas-Tight Connections

The acid-tin plating on our terminals means more than just improved shelf-life and superior solderability. It is to provide the very basis for the heart of your wire connections.

#### Quality Plating

Tyco Electronics Corporation has been known for its plating, especially on the tin-plated components, and has maintained stringent plating specifications to provide a better performing, more reliable product. (Terminals meet or exceed Tyco Electronics Specification 109-11-1.)

#### UL Recognition and CSA Certification

Terminal blocks and interconnect components are Recognized under the Component Recognition Program of Underwriters Laboratories Inc. and Certified by Canadian Standards Association. (Consult individual sections of this catalog for status of a specific series.)

#### Typical Application

Pictured below is a PC board with barrier strips and sockets wave soldered to it.



**Tri-Barrier Strips**

**Product Facts**

- n Industrial controls and automation
- n Machine tools
- n HVAC/R
- n Power supplies
- n Security/Irrigation
- n Transformers

**Design Advantages**

- n Back barriers to safeguard field wiring
- n Fast wiring – backed-out wire-ready screws
- n Interrupted thread designed to prevent screws from falling out
- n Standoffs allow flux and solvents to drain during cleaning
- n Molded-to-length or cut-to-length versions available
- n Phil-slot screws are standard
- n RoHS compatible

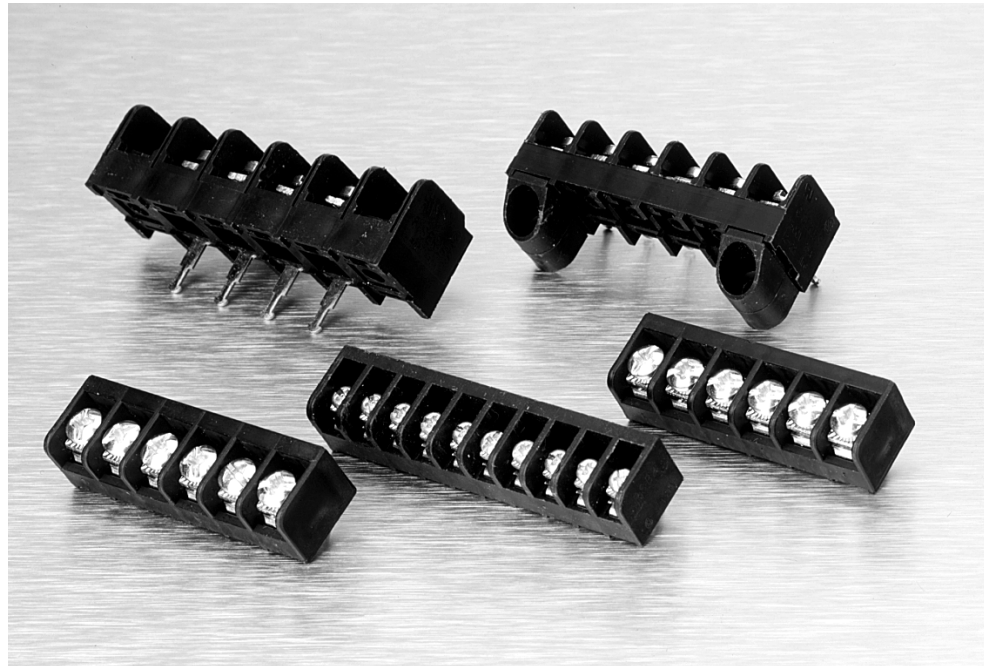

Tri-Barrier blocks help contain stray or frayed wire ends. This helps prevent electrical shorts — not only between positions on the same block, but also between other components immediately adjacent to the block. With today’s high-density PCB designs, this has become an increasingly important feature.

**Connector Index**

0.250" Pitch, Series #3 .....	120-123
0.325" Pitch, Series #4 .....	124-126
0.325" Pitch, with Attached Safety Cover .....	127
0.375" Pitch, Series #6 .....	128-135
0.375" Pitch, Modular with Cover .....	132
0.375" Pitch, Series BC6, Panel Mount.....	133,134
0.375" Pitch, Series MB6, Double Level .....	135
0.4375" Pitch, Series #8 .....	136-138



**Note:** All part numbers are RoHS Compliant.

**.250" [6.35] Pitch, Series #3**

**3PCV-03-006 & 3PCV-10-006**



**Material & Finish**

**Housing Material**—Polypropylene

**Flammability**—UL94V-0

**Color**—Black

**Terminals**—Bright acid tin over copper alloy

**Screws**—Steel, zinc plating with clear chromate coating. Wire clamping screws standard.

**Mechanical Properties**

**Pitch (Terminal Spacing)**—0.250" [6.35]

**Recommended PCB Hole Dia.**—1.8mm [.073"] Recommended Tightening Torque: 5.5 in.-lbs.

**Electrical Properties**

**Ratings**—UL Class C 10 Amps, 150V  
UL Class D 10 Amps, 300V  
CSA Type C 10 Amps, 150V  
CSA Type D 10 Amps, 300V

**Wire Range**—18-22 AWG

**Environmental Properties**

**Operating Temperature Range**—105°C [221°F] max.

**Circuit Identification**—See page 179

**Hardware Options**

**TC3**—Safety cover, see page 174

**J3**—Jumper, see page 177



RIGHT ANGLE MOUNTING PANEL LAYOUT VERTICAL



RIGHT ANGLE PRINTED CIRCUIT LAYOUT CENTER

**Note:** All part numbers are RoHS Compliant.

**.250" [6.35] Pitch, Series #3 (Continued)**

**Ordering Information**

**3 PCV - 04 - 006**

- A** Thread Size Spacing  
3 = #m3 on .250" Centers
- B** Terminal Style  
  - PCV** = Printed Circuit Pin, Vertical
  - PCR** = Printed Circuit, Right Angle
  - STV** = Solder Turret, Vertical
  - STR** = Solder Turret, Right Angle
  - WWV** = Solderless Wire Wrap, Vertical
- C** No. of Circuits (Not Positions)  
02 through 32
- D** Modifier  
Use table below.

Terminal Style	Modifier Phil-slot Head	Screw Style	Mounting Construction
PCV	006	Wire Clamp	No Mounting
	008	Wire Clamp	
PCR	006	Wire Clamp	No Mounting
	008	Wire Clamp	
STV WWV	006	Wire Clamp	
	008	Wire Clamp	No Mounting
STR	006	Wire Clamp	
	008	Wire Clamp	



**Note:** All part numbers are RoHS Compliant.

**.250" [6.35] Pitch, Series #3 (Continued)**

**Printed Circuit Pin**



**Solder Turret**



**Wire Wrap**

#3WWR not available



**Note:** All part numbers are RoHS Compliant.

**.250" [6.35] Pitch, Series #3 (Continued)**



No. of Positions	Dim. A	No. of Positions	Dim. A
2	0.25 [6.3]	18	4.25 [107.9]
3	0.50 [12.7]	19	4.50 [114.3]
4	0.75 [19.0]	20	4.75 [120.6]
5	1.00 [25.4]	21	5.00 [127.0]
6	1.25 [31.7]	22	5.25 [133.3]
7	1.50 [38.1]	23	5.50 [139.7]
8	1.75 [44.4]	24	5.75 [146.0]
9	2.00 [50.8]	25	6.00 [152.4]
10	2.25 [57.1]	26	6.25 [158.8]
11	2.50 [63.5]	27	6.50 [165.1]
12	2.75 [69.8]	28	6.75 [171.5]
13	3.00 [76.2]	29	7.00 [177.8]
14	3.25 [82.5]	30	7.25 [184.2]
15	3.50 [88.9]	31	7.50 [190.5]
16	3.75 [95.2]	32	7.75 [196.9]
17	4.00 [101.6]		

Barrier Strips

2



**0.325" [8.26] Pitch, Series #4, Tri-Barrier**

**4PCV-06-006**



**Material & Finish**

**Housing Material**—Polyamide

**Flammability**—UL94V-0

**Color**—Black

**Terminals**—Bright acid tin over copper alloy

**Screws**—#4-40 steel, zinc plating with clear chromate coating. Wire clamping screw and binding head screw available.

**Mechanical Properties**

**Pitch (Terminal Spacing)**—0.325" [8.255]

**Recommended PCB Hole Dia.**—1.8mm [.073"]

**Recommended Tightening Torque**—7 in.-lbs. max.

**Electrical Properties**

**Ratings**—UL Class C 20 Amps, 150V  
UL Class D 10 Amps, 300V  
CSA Type C 20 Amps, 150V  
CSA Type D 10 Amps, 300V

**Wire Range**—12-22 AWG

**Environmental Properties**

**Operating Temperature Range**—105°C [221°F] max.

**Circuit Identification**—See page 179

**Hardware Options**

**TC4**—Safety cover, see page 174

**8-1437649-0**—Wire clamp screw, see page 178

**8-1437649-0**—Binding head screw, see page 178

**J4**—Jumper, see page 177

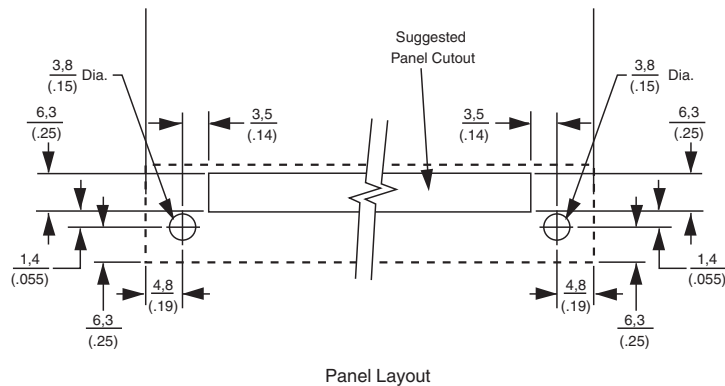

**Note:** All part numbers are RoHS Compliant.

**0.325" [8.26] Pitch, Series #4, Tri-Barrier (Continued)**

**Ordering Information**

**4 PCV-04-006**

**A**      **B**      **C**      **D**

**A Screw Size Spacing**

4 = #4-40 on .325" Centers

**C No. of Circuits (Not Positions)**

02 through 30

**B Terminal Style**

**DBL** = Double Printed Circuit Pin

**PCR** = Printed Circuit, Right Angle

**PCV** = Printed Circuit Pin, Vertical

**WWV** = Solderless Wire Wrap, Vertical

**D Modifiers**

Use table below.

Terminal Style	Modifier Phil-slot Head	Screw Style	Mounting Construction
DBL	006	Wire Clamp	No Mounting
PCV	006	Wire Clamp	No Mounting
	008	Wire Clamp	
PCR	006	Wire Clamp	No Mounting
	008	Wire Clamp	
WWV	006	Wire Clamp	
	008	Wire Clamp	No Mounting

Barrier Strips  
**2**



**Note:** All part numbers are RoHS Compliant.

**0.325" [8.26] Pitch, Series #4, Tri-Barrier (Continued)**

**Printed Circuit Pin**

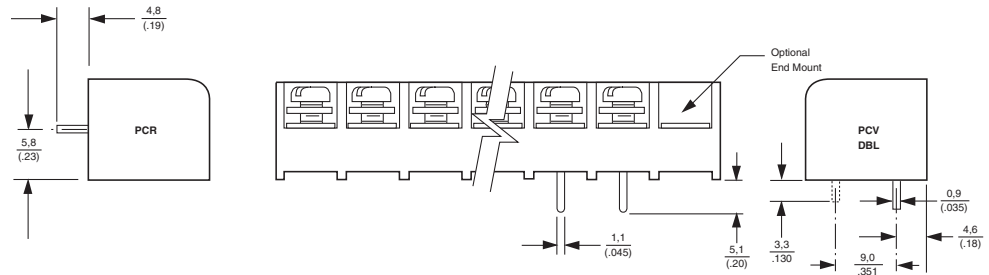

**Wire Wrap**

#4 WWR Not available



**0.325" Pitch, Series #4, Tri-Barrier**



No. of Positions	Dim. A	No. of Positions	Dim. A
2	(0.325) 8,2	17	(5.20) 132,1
3	(0.65) 16,5	18	(5.52) 140,3
4	(0.97) 24,7	19	(5.85) 148,6
5	(1.30) 33,0	20	(6.17) 156,8
6	(1.62) 41,3	21	(6.50) 165,1
7	(1.95) 49,5	22	(6.82) 173,3
8	(2.27) 57,8	23	(7.15) 181,6
9	(2.60) 66,0	24	(7.47) 189,9
10	(2.92) 74,3	25	(7.80) 198,1
11	(3.25) 82,5	26	(8.13) 206,4
12	(3.57) 90,8	27	(8.45) 214,6
13	(3.90) 99,1	28	(8.78) 222,9
14	(4.22) 107,3	29	(9.10) 231,1
15	(4.55) 115,6	30	(9.43) 239,4
16	(4.87) 123,8		



**Note:** All part numbers are RoHS Compliant.

**Tri-Barrier Strips with Attached Safety Covers, .325" [8.26] Centerline**

**Product Facts**

- ▢ **Screwdriver access holes in cover allow for efficient wiring; cover may remain closed**



**Material & Finish**

**Insulator Body**—UL 94V-0 Thermoplastic, black

**Terminal**—Brass, tin-plated

**Mechanical Properties**

**Recommended screw tightening torque**—12 in-lbs

Combination drive screws with #2 Phillips recess and standard slot

**Electrical Properties**

**Current Rating**—15 A

**Voltage Rating**—300 VAC/DC

**Wire Range**—22-14 AWG, Cu, Solid or Stranded

**Environmental Properties**

**Operating Temperature**—-40°C to +120°C [-104°F to +248°F]

**Circuit Identification**—See page 179

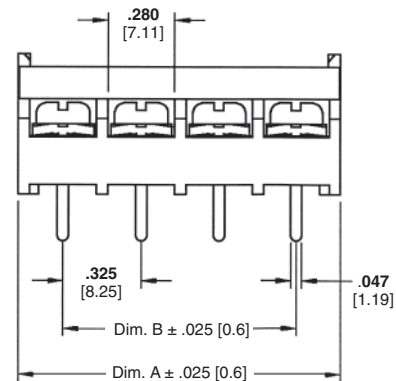
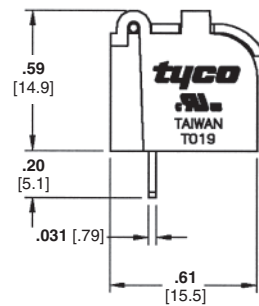
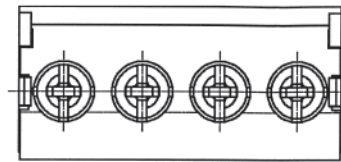

No. of Position*	Dimensions		Part Numbers
	A	B	
2	0.697 [17.7]	0.325 [8.3]	1546927-2
3	1.022 [26.0]	0.650 [16.5]	1546927-3
4	1.347 [34.2]	0.975 [24.8]	1546927-4
5	1.672 [42.5]	1.300 [33.0]	1546927-5
6	1.997 [50.7]	1.625 [41.3]	1546927-6
7	2.322 [59.0]	1.950 [49.5]	1546927-7
8	2.647 [67.2]	2.275 [57.8]	1546927-8

\*Contact Tyco Electronics for larger position sizes.  
Note: Samples available in Sample Room.



**Note:** All part numbers are RoHS Compliant.

**0.375" [9.53] Pitch, Series #6, Tri-Barrier**

**6PCV-03-006 & 6PCV-06-006**

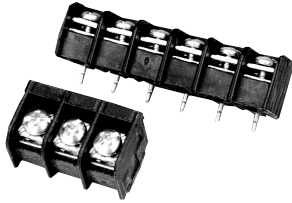

Right Angle  
Printed Circuit Board Layout

**Material & Finish**

**Housing Material**—Polyamide

**Flammability**—UL94V-0

**Color**—Black

**Terminals**—Bright acid tin over copper alloy

**Screws**—#6-32 steel, zinc plating with clear chromate coating. Wire clamping screws and binding head screws with undercut available.

**Mechanical Properties**

**Pitch (Terminal Spacing)**—0.375" [9.53]

**Recommended PCB Hole Dia.**—1.8mm [.073"]

**Electrical Properties**

**Ratings**—UL Class C 25 Amps, 300V  
UL Class D 5 Amps, 600V  
CSA Type C 25 Amps, 300V  
CSA Type D 5 Amps, 600V

**Wire Range**—18-22 AWG

**Environmental Properties**

**Operating Temperature Range**—105°C [221°F] max.

**Circuit Identification**—See page 179

**Hardware Options**

**QC6**—Quick connects, see page 176

**ST80**—Single sided solder tabs, see page 176

**J6**—Jumpers, see page 177

**TC6**—Safety covers, see page 174

**1437651-2**—Wire clamp screw, steel, see page 178

**1437651-5**—Wire clamp screw, brass, see page 178

**1437651-8**—Binding head screw, steel, see page 178

**L03**—Binding head screw, stainless, see page 178



Right Angle  
Mounting Panel Layout



**Note:** All part numbers are RoHS Compliant.

**0.375" [9.53] Pitch, Series #6, Tri-Barrier (Continued)**

# 6 PCV-04-006

**A**      **B**      **C**      **D**

- A Screw Size Spacing**  
6 = #6-32 on .375" Centers
- B Terminal Style**  
**DBL** = Double Printed Circuit Pin  
**PCR** = Printed Circuit, Right Angle  
**PCV** = Printed Circuit Pin, Vertical  
**STR** = Solder Turret, Right Angle  
**STV** = Solder Turret, Vertical  
**TBV** = Non Feed Thru  
**WWR** = Solderless Wire Wrap, Right Angle  
**WWV** = Solderless Wire Wrap, Vertical
- C No. of Circuits (Not positions)**  
02 through 30
- D Modifiers**  
Use table below.  
 -002=-006 except brass screw  
 -003=-007 except brass screw

Terminal Style	Modifier Phil-slot Head	Screw Style	Mounting Construction
DBL	006	Wire Clamp	No Mounting
	007	Binding Head	
PCV	006	Wire Clamp	No Mounting
	007	Binding Head	
	008	Wire Clamp	
	009	Binding Head	
PCR	006	Wire Clamp	No Mounting
	007	Binding Head	
	008	Wire Clamp	
	009	Binding Head	
STV WWV	006	Wire Clamp	
	008	Wire Clamp	
STR WWR	006	Wire Clamp	
	008	Wire Clamp	
TBV	006	Wire Clamp	



Barrier Strips

2

**Note:** All part numbers are RoHS Compliant.

**0.375" [9.53] Pitch, Series #6, Tri-Barrier (Continued)**



No. of Positions	Dim. A	No. of Positions	Dim. A
2	0.375 [9.5]	17	6.00 [152.4]
3	0.75 [19.1]	18	6.37 [161.9]
4	1.12 [28.6]	19	6.75 [171.4]
5	1.50 [38.1]	20	7.12 [181.9]
6	1.87 [47.6]	21	7.50 [190.5]
7	2.25 [57.1]	22	7.87 [200.0]
8	2.62 [66.7]	23	8.25 [209.5]
9	3.00 [76.2]	24	8.62 [219.1]
10	3.37 [85.7]	25	9.00 [228.6]
11	3.75 [95.2]	26	9.38 [238.1]
12	4.12 [104.8]	27	9.75 [247.7]
13	4.50 [114.3]	28	10.13 [257.2]
14	4.87 [123.8]	29	10.50 [266.7]
15	5.25 [133.3]	30	10.88 [276.2]
16	5.62 [142.9]		



**Note:** All part numbers are RoHS Compliant.

**0.375" [9.53] Pitch, Series #6, Tri-Barrier (Continued)**

**Printed Circuit Pin**



**Solder Turret**

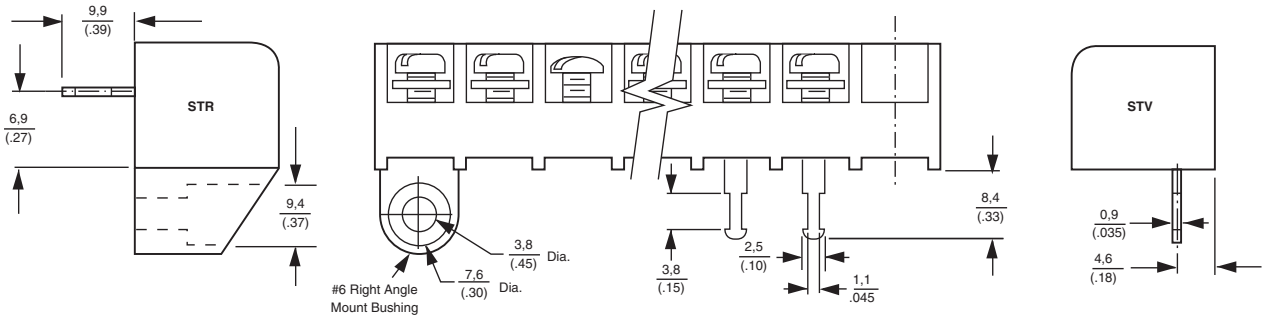

**Wire Wrap**



**Non-Feed Thru**



Barrier Strips

2



**Note:** All part numbers are RoHS Compliant.

**0.375" [9.53] Pitch, Modular w/cover, Tri-Barrier**

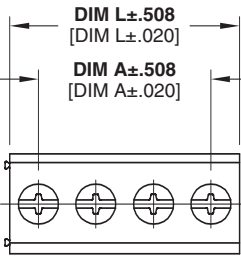

**Material & Finish**

**Housing Material**—Polyamide

**Flammability**—UL94V-0

**Color**—Black

**Terminals**—Brass, tin-plated

**Screws**—m3.5, steel, nickel plated

**Mechanical Properties**

**Pitch (Terminal Spacing)**—  
0.375" [9.53]

**Recommended PCB Hole Dia.**—  
1.8mm [0.073"]

**Recommended Tightening Torque**—  
12 in.-lb.

**Electrical Properties**

**Ratings\***—UL Class B 15 Amps, 300V  
UL Class D 10 Amps, 300V

\*Evaluated to U.S. and Canadian Standards.

**Wire Range**—18-22 AWG

**Environmental Properties**

**Operating Temperature Range**—  
-40°C to +120°C [-104°F to +248°F]

**Circuit Identification**—See page 179

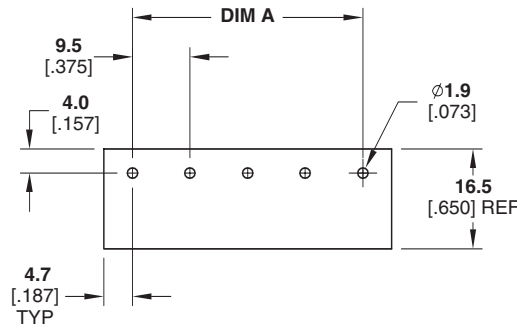
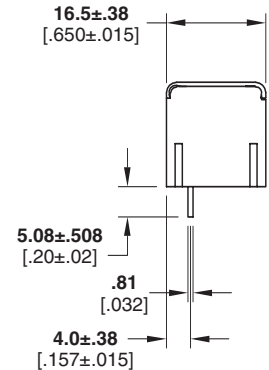
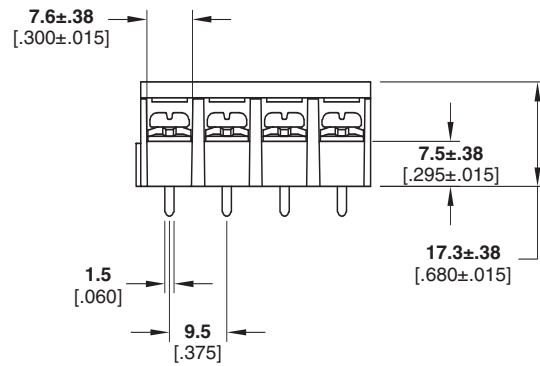

Recommended PC Board Layout

No. of Positions	Dimension A	Part Numbers
2	.375 [9.5]	1546833-2
3	.750 [19.0]	1546833-3
4	1.125 [28.6]	1546833-4
5	1.500 [38.1]	1546833-5
6	1.875 [47.6]	1546833-6
7	2.250 [57.1]	1546833-7
8	2.625 [66.7]	1546833-8



**Note:** All part numbers are RoHS Compliant.

**0.375" [9.53] Pitch, Series BC6**

No. of Positions	Dim. A
2	.375 [9.5]
3	.750 [19.1]
4	1.125 [28.6]
5	1.500 [38.1]
6	1.875 [47.6]
7	2.250 [57.1]
8	2.625 [66.7]
9	3.000 [76.2]

No. of Positions	Dim. A
10	3.375 [85.7]
11	3.750 [95.2]
12	4.125 [104.8]
13	4.500 [114.3]
14	4.875 [123.8]
15	5.250 [133.3]
16	5.625 [142.9]

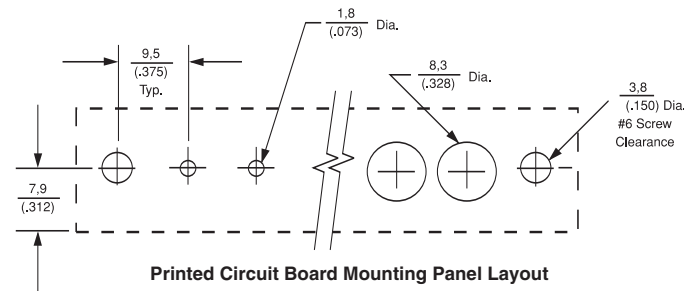

## 0.375" [9.53] Pitch, Series BC6

### Ordering Information



**BC6 - P 1 08 - 08**  
A
B
C
D

#### Material & Finish

**Housing Material**—Polypropylene

**Flammability**—UL94V-0

**Color**—Black

**Terminals**—Bright acid tin over copper alloy

**Screws**—#6-32 steel, zinc plating with clear chromate coating. Wire clamping screws and binding head screws available.

#### Mechanical Properties

**Pitch (Terminal Spacing)**—0.375" [.525]

**Recommended PCB Hole Dia.**—1.8mm [.073"]

#### Electrical Properties

**Ratings**—UL Class C 20 Amps, 300V  
 UL Class D 5 Amps, 600V  
 CSA Type C 20 Amps, 300V

**Wire Range**—12-22 AWG

#### Environmental Properties

**Operating Temperature Range**—105°C [221°F] max.

**Circuit Identification**—See page 179

#### Hardware Options

**TC2**—Safety covers, see page 174

**QC2x**—250 Quick connects, see page 176

**QC4x**—187 Quick connects, see page 176

**ST80**—Single sided solder tabs, see page 176

**1437661-7**—Retaining clip, Insulating turret, see page 178

**J6**—Jumpers, see page 177

**1437651-2**—Wire clamp screw, steel, see page 178

**1437651-5**—Wire clamp screw, brass, see page 178

**1437651-8**—Binding head screw, steel, see page 178

**L03**—Binding head screw, stainless, see page 178

#### A Terminal Style

P=Printed Circuit (available with 1,2,5 block style only)

T=Solder Turret

Q=Quick Connect .250

W=Solderless Wrap

E=Extended Circuit Board

F=Quick Connect .187

#### B Block Style

1=Flat, all positions filled (standard)

2=Flat, end mounting ears with holes (required for cover option)

3=Insulating turret, end mounting ears with holes (required for cover option)

4=Insulating turret, all positions filled

5=Flat, end positions open with mounting bushings

6=Insulating turret, end positions open with mounting bushings

#### C Screw Hardware

07=Steel binding combo head screw

08=Steel wire-clamp combo head screw (standard)

05=Brass binding combo head screw

06=Brass wire-clamp combo head screw

#### D No. of Circuits (Not Positions)

02 to 25 circuits

**Note:** All part numbers are RoHS Compliant.

**0.375" [9.53] Pitch, Series MB6, Double Level**

**MB6-P108-##**



**Material & Finish**

**Housing Material**—Thermoplastic polyamide

**Flammability**—UL94V-0

**Color**—Black

**Terminals**—Bright acid tin over copper alloy

**Screws**—#6-32 steel, zinc plating with clear chromate coating.

**Mechanical Properties**

**Pitch (Terminal Spacing)**— .375" [9.525]

**Recommended PCB Hole Dia.**— 1.8mm [.073"]

**Electrical Properties**

**Ratings**—UL Class C 25 Amps, 300V  
CSA Type C 25 Amps, 600V

**Wire Range**—12-22 AWG

**Environmental Properties**

**Operating Temperature Range**— 105°C [221°F] max.

**Hardware Options**

**1437651-2**—Wire clamp screw, see page 178

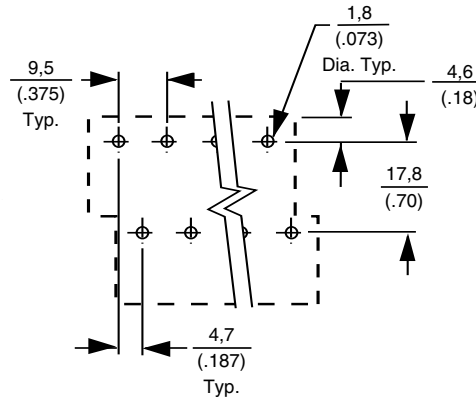

Printed Circuit Board Layout

**ORDERING INFORMATION**

**MB6 - P1 08 - 04**

- A Series**  
MB6=Double Level, 0.375" Centers
- B Terminal Style**  
P1=Printed Circuit Pin, Vertical
- C Screw Hardware**  
08=Steel wire clamp combo head screws
- D 02 through 40** available in multiples of 2

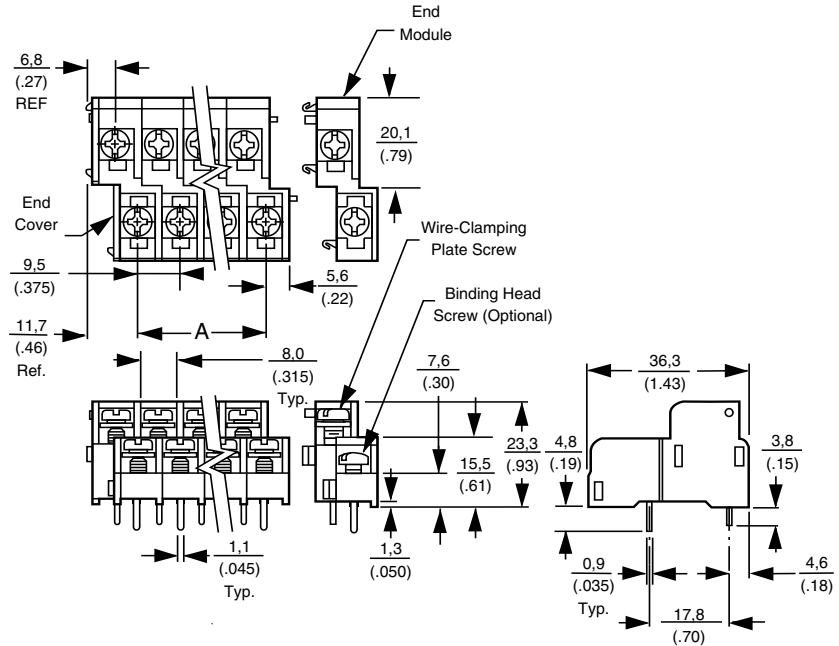

No. of Positions	Dim. A	No. of Positions	Dim. A
4	0.375 [9.5]	24	4.125 [104.8]
6	0.750 [19.1]	26	4.500 [114.3]
8	1.125 [28.6]	28	4.875 [123.8]
10	1.500 [38.1]	30	5.250 [133.3]
12	1.875 [47.6]	32	5.625 [142.9]
14	2.250 [57.1]	34	6.000 [152.4]
16	2.625 [66.7]	36	6.375 [161.9]
18	3.000 [76.2]	38	6.750 [171.4]
20	3.375 [85.7]	*40	7.125 [181.0]
22	3.750 [95.2]		

\* Longer lengths available. Please consult Technical Support.



Barrier Strips

2



**Note:** All part numbers are RoHS Compliant.

**0.4375" [11.1] Pitch, Series #8**

**#8 Series Tri-Barriers**



**RIGHT ANGLE VERTICAL PRINTED CIRCUIT BOARD LAYOUT**

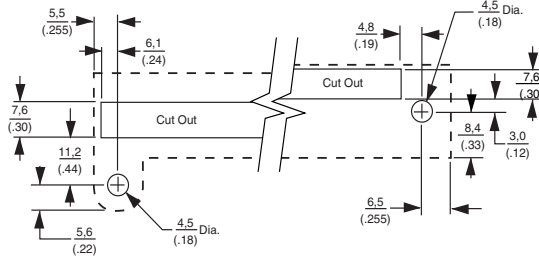

**RIGHT ANGLE VERTICAL MOUNTING PANEL LAYOUT**

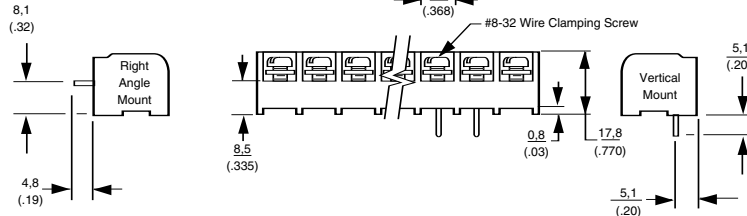
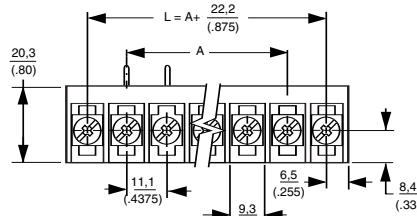

**Material & Finish**

**Housing Material**—Polypropylene

**Flammability**—UL94V-0

**Color**—Black

**Terminals**—Bright acid tin over copper alloy

**Screws**—#8-32 steel, zinc plating with clear chromate coating. Wire clamping screws and binding head screws with undercut available.

**Mechanical Properties**

**Pitch (Terminal Spacing)**—0.4375" [11.1]

**Recommended PCB Hole Dia.**—1.8mm [.073"]

**Electrical Properties**

**Ratings**—UL Class C 30 Amps, 600V  
CSA Type C 30 Amps, 600V

**Wire Range**—10-18 AWG (UL)  
10-22 AWG (CSA)

**Environmental Properties**

**Operating Temperature Range**—105°C [221°F] max.

**Circuit Identification**—See page 179

**Hardware Options**

**TC8**—Safety covers, see page 174

**QC8**—Quick connects, see page 176

**J8**—Jumpers, see page 177

**1437425-1**—Wire clamp screw, see page 178

**1437429-1**—Binding head screw, steel, see page 178

No. of Positions	Dim. A
2	0.4375 [11.1]
3	0.87 [22.2]
4	1.31 [33.3]
5	1.75 [44.5]
6	2.19 [55.6]
7	2.62 [66.7]
8	3.06 [77.8]
9	3.50 [88.9]
10	3.93 [100.0]
11	4.37 [111.1]
12	4.81 [122.2]
13	5.25 [133.3]
14	5.69 [144.5]

No. of Positions	Dim. A
15	6.12 [155.6]
16	6.56 [166.7]
17	7.00 [177.8]
18	7.44 [188.9]
19	7.87 [200.0]
20	8.31 [211.1]
21	8.75 [222.2]
22	9.19 [233.4]
23	9.62 [244.5]
24	10.06 [255.6]
25	10.50 [266.7]
26	10.94 [277.8]



**0.4375" [11.1] Pitch, Series #8** (Continued)

**Ordering Information**

**8 PCV-04-006**

**A**      **B**      **C**      **D**

**A Screw Size Spacing**

8 = #8-32 on .4375" Centers

**C No. of Circuits** (Not positions)

02 through 26

**B Terminal Style**

- DBL** = Double Printed Circuit Pin
- PCR** = Printed Circuit, Right Angle
- PCV** = Printed Circuit Pin, Vertical
- QCR** = Quick Connect Tab, Right Angle
- QCV** = Quick Connect Tab, Vertical
- STR** = Solder Turret, Right Angle
- STV** = Solder Turret, Vertical
- TBV** = Non Feed Thru
- WWR** = Solderless Wire Wrap, Right Angle
- WWV** = Solderless Wire Wrap, Vertical

**D Modifiers**

- Use table below.
- 002=-006 except brass screw
- 003=-007 except brass screw



Phil-slot Head

Terminal Style	Modifier Phil-slot Head	Screw Style	Mounting Construction
DBL	006	Wire Clamp	No Mounting
	007	Binding Head	
PCV	006	Wire Clamp	No Mounting
	007	Binding Head	
	008	Wire Clamp	
	009	Binding Head	
PCR	006	Wire Clamp	
	007	Binding Head	
	008	Wire Clamp	
	009	Binding Head	
QCV	006	Wire Clamp	
STV		Wire Clamp	
WWV		Wire Clamp	
QCR	006	Wire Clamp	
STR		Wire Clamp	
WWR	008	Wire Clamp	
TBV		Wire Clamp	



**Note:** All part numbers are RoHS Compliant.

**0.4375" [11.1] Pitch, Series #8 (Continued)**

**Printed Circuit Pin**



**Solder Turret**

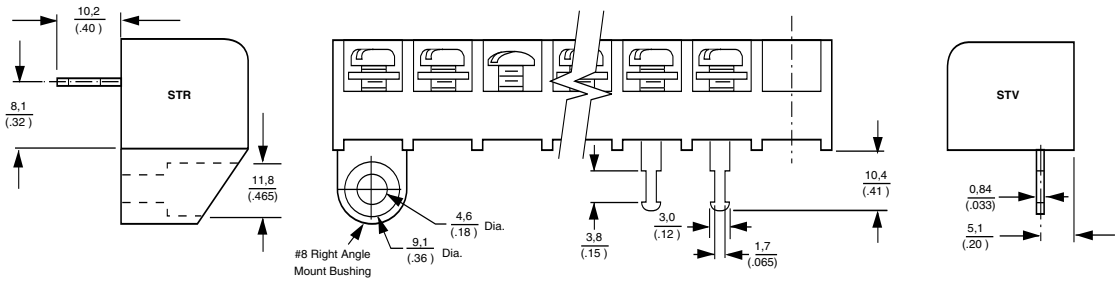

**Wire Wrap**

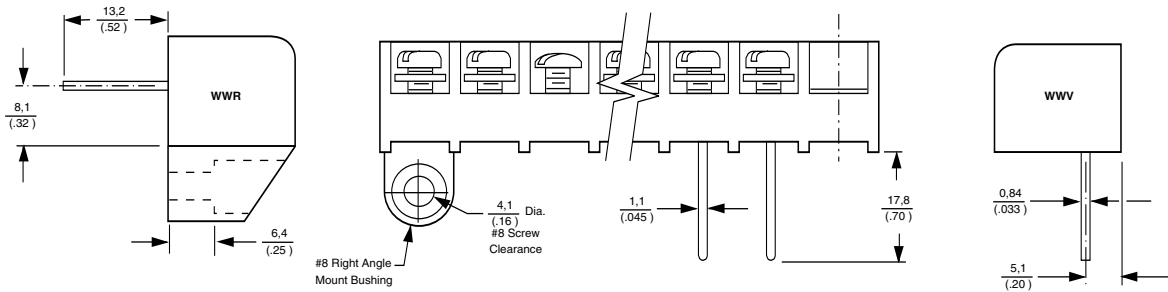

**Quick Connect**

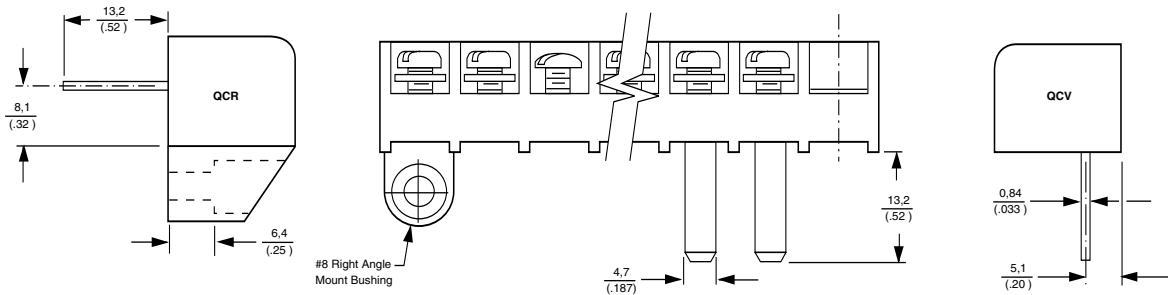

**Non-Feed Thru**

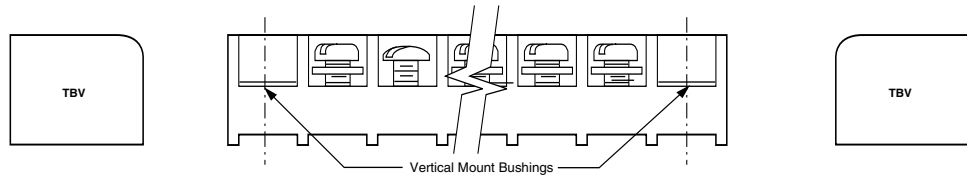

**Dual-Barrier Strips**

**Product Facts**

- n Industrial controls and automation
- n Machine tools
- n HVAC/R
- n Power supplies
- n Security/Irrigation
- n Transformers

**Design Advantages**

- n Fast wiring – backed-out wire-ready screws
- n Interrupted thread designed to prevent screws from falling out
- n Standoffs allow flux and solvents to drain during cleaning
- n Molded-to-length or cut-to-length versions available



The Dual-Barrier design provides a more cost-effective solution than the Tri-Barrier Strips while still supplying many of the design advantages.

**Connector Index**

**Single Row**

0.250" Pitch, Series 1546657 .....	141, 142
0.325" Pitch, Series 4DB .....	143-144
0.325" Pitch, High Rise .....	145-146
0.325" Pitch, Series SSB3.....	168-170
0.375" Pitch, Series JC6 .....	147, 148
0.375" Pitch, Series NC6, Low Profile .....	149, 150
0.4375" Pitch, Series SSB7.....	151-154

**Double Row, Panel Mount**

0.374" Pitch .....	156
0.433" Pitch .....	157
0.437" Pitch .....	158
0.563" Pitch .....	160

**Note:** All part numbers  
are RoHS Compliant.

---

## Engineering Notes

---



**High-Density, Dual-Barrier Strips, .250" [6.35] Centerline**

**Product Facts**

- High density accommodates today's compact PCB layouts



**Material & Finish**

- Insulator Body**—UL 94V-0 thermoplastic, black
- Terminal**—Brass, tin-plated
- Screw**—M3, Steel, nickel-plated

**Mechanical Properties**

- Recommended Tightening Torque**—10 in-lbs
- Combination drive screws with #2 Phillips recess and standard slot

**Electrical Properties**

- Current Rating**—10 A
- Voltage Rating**—300 VAC/DC per UL and CSA standards
- Wire Range**—16-30 AWG Copper, Solid or Stranded

**Environmental Properties**

- Operating Temperature**—40°F to +221°F [-40°C to +115°C]
- Circuit Identification**—See page 179

**Hardware Options**

- TC8**—Safety cover, see page 174
- QC8**—Quick connects, see page 176
- J8**—Jumpers, see page 177
- 1437425-1**—Wire clamp screw, see page 178
- 1437429-1**—Binding head screw, steel, see page 178



**Note:** All part numbers are RoHS Compliant.

**High-Density, Dual-Barrier Strips, .250" [6.35] Centerline (Continued)**

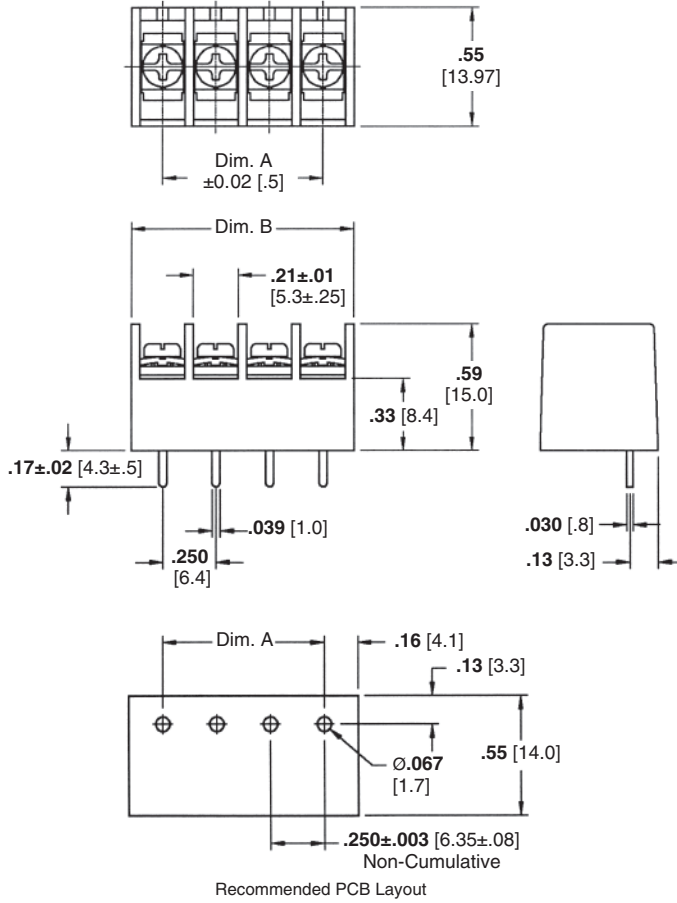

No. of Positions	Dimension		Part Number
	A	B	
2	0.250 [6.35]	0.54 [13.7]	1546657-2
3	0.500 [12.7]	0.79 [20.1]	1546657-3
4	0.750 [19.1]	1.04 [26.4]	1546657-4
5	1.000 [25.4]	1.29 [32.8]	1546657-5
6	1.250 [31.8]	1.54 [39.1]	1546657-6
7	1.500 [38.1]	1.79 [45.5]	1546657-7
8	1.750 [44.4]	2.04 [51.8]	1546657-8
9	2.000 [50.8]	2.29 [58.2]	1546657-9
10	2.250 [57.2]	2.54 [64.5]	1-1546657-0
11	2.500 [63.5]	2.79 [70.9]	1-1546657-1
12	2.750 [69.9]	3.04 [77.2]	1-1546657-2
13	3.000 [76.2]	3.29 [83.6]	1-1546657-3
14	3.250 [82.6]	3.54 [90.0]	1-1546657-4
15	3.500 [88.9]	3.79 [96.3]	1-1546657-5

No. of Positions	Dimension		Part Number
	A	B	
16	3.750 [95.3]	4.04 [102.6]	1-1546657-6
17	4.000 [101.6]	4.29 [108.9]	1-1546657-7
18	4.250 [107.9]	4.54 [115.3]	1-1546657-8
19	4.500 [114.3]	4.79 [121.7]	1-1546657-9
20	4.750 [120.6]	5.04 [128.0]	2-1546657-0
21	5.000 [127.0]	5.29 [134.4]	2-1546657-1
22	5.250 [133.3]	5.54 [140.7]	2-1546657-2
23	5.500 [139.7]	5.79 [147.1]	2-1546657-3
24	5.750 [146.1]	6.04 [153.4]	2-1546657-4
25	6.000 [152.4]	6.29 [159.8]	2-1546657-5
26	6.250 [158.8]	6.54 [166.1]	2-1546657-6
27	6.500 [165.1]	6.79 [172.5]	2-1546657-7
28	6.750 [171.5]	7.04 [178.8]	2-1546657-8
29	7.000 [177.8]	7.29 [185.2]	2-1546657-9
30	7.250 [184.2]	7.54 [191.5]	3-1546657-0



0.325" [8.26] Pitch, Series 4DB

4DB-P108-##

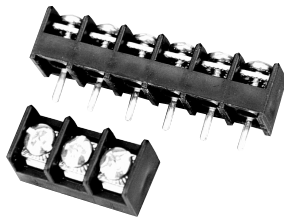

**Material & Finish**

**Housing Material**—Thermoplastic Polyamide

**Flammability**—UL94V-0

**Color**—Black

**Terminals**—Bright acid-tin over copper alloy

**Screws**—#6-32 steel, zinc plating with clear chromate coating. Wire clamping screws and binding head screws available.

**Mechanical Properties**

**Pitch (Terminal Spacing)**—0.325" [9.525]

**Recommended PCB Hole Dia.**—1.7mm [0.07"]

**Electrical Properties**

**Ratings**—UL Class C 20 Amps, 150V  
 UL Class D 10 Amps, 300V  
 CSA Type B 20 Amps, 300V  
 CSA Type C 20 Amps, 300V  
 CSA Type D 10 Amps, 300V  
 CSA Type E 20 Amps, 300V

**Wire Range**—12-22 AWG

**Environmental Properties**

**Operating Temperature Range**—105°C [221°F] max.

**Circuit Identification**—See page 179

**Hardware Options**

**QC4**—Quick connects, see page 176

**J4**—Jumpers, see page 177

**9-1437667-9**—Wire clamp screw, see page 178

**Ordering Information**

**4DB - P 1 08 - 06**

**A**      **B**      **C**      **D**      **E**

**A Series**

4DB = Dual-Barrier, 0.325" Centers

**B Terminal Style**

P = Printed Circuit Pin

W = Wire Wrap

R = Right Angle

**C Block Style**

1 = Flat, all positions filled

2 = Flat, end mounting holes

**D Screw Type**

07 = Steel binding combo head screws

08 = Steel wire clamp combo head screws

**E No. of Circuits (Not Positions)**

02 through 30



**Note:** All part numbers are RoHS Compliant.

**0.325" [8.26] Pitch, Series 4DB (Continued)**



PRINTED CIRCUIT BOARD LAYOUT

**Bend Options:**

A variety of bend options are available. Please consult Technical Support for details.



No. of Positions	Dim. A	No. of Positions	Dim. A
2	0.325 [8.2]	17	5.200 [132.1]
3	0.650 [16.5]	18	5.525 [140.3]
4	0.975 [24.8]	19	5.850 [148.6]
5	1.300 [33.0]	20	6.175 [156.8]
6	1.625 [41.3]	21	6.500 [165.1]
7	1.950 [49.5]	22	6.825 [173.3]
8	2.275 [57.8]	23	7.150 [181.6]
9	2.600 [66.0]	24	7.475 [190.0]
10	2.925 [74.3]	25	7.800 [198.1]
11	3.250 [82.5]	26	8.125 [206.4]
12	3.575 [90.8]	27	8.450 [214.6]
13	3.900 [99.1]	28	8.775 [222.8]
14	4.225 [107.3]	29	9.100 [231.1]
15	4.550 [115.6]	30	9.425 [239.4]
16	4.875 [123.8]		



## High Rise Dual-Barrier Strips, .325 [8.26] Centerline

### Product Facts

- High rise profile provides wire entry access on congested PC boards
- Space saving high rise design allows for dual-level wire entry when used with 4DB series barrier strips
- Captive screws provided in wire-ready position



### Material & Finish

**Insulator Body**—UL 94V-0 Thermoplastic, Black

**Terminal**—Brass, Tin plated

### Mechanical Properties

#### Recommended Tightening

**Torque**—10 in-lbs

Combination drive screws with #2 Phillips Recess and Standard Slot

### Electrical Properties

**Current Rating**—10 A

**Voltage Rating**—20 A, 300 VAC/DC per UL and CSA standards

**Wire Range**—12-22 AWG Cu, Solid or Stranded

### Environmental Properties

**Operating Temperature**—40°F to +221°F [-40°C to +105°C]

**Circuit Identification**—See page 179

### Hardware Options

**J4**—Jumpers, see page 177

**Note:** All part numbers are RoHS Compliant.

**High Rise Dual-Barrier Strips, .325 [8.26] Centerline** (Continued)



**Recommended PC Board Layout**

No of Positions	Dimension		Part Number
	A	B	
2	0.725 [18.42]	0.325 [8.26]	1546734-2
3	1.050 [26.67]	0.650 [16.51]	1546734-3
4	1.375 [34.93]	0.975 [24.77]	1546734-4
5	1.700 [43.18]	1.300 [33.02]	1546734-5
6	2.025 [51.44]	1.625 [41.28]	1546734-6
7	2.350 [59.69]	1.950 [49.53]	1546734-7
8	2.675 [67.95]	2.275 [57.79]	1546734-8
9	3.000 [76.20]	2.600 [66.04]	1546734-9
10	3.325 [84.46]	2.925 [74.29]	1-1546734-0
11	3.650 [92.71]	3.250 [82.55]	1-1546734-1
12	3.975 [100.97]	3.575 [90.81]	1-1546734-2
13	4.300 [109.22]	3.900 [99.06]	1-1546734-3
14	4.625 [117.48]	4.225 [107.32]	1-1546734-4
15	4.950 [125.73]	4.550 [115.57]	1-1546734-5
16	5.275 [133.99]	4.875 [123.83]	1-1546734-6



## 0.375" [9.53] Pitch, Series JC6

### JC6-P107-03



#### Material & Finish

**Housing Material**—Polypropylene

**Flammability**—UL94V-0

**Color**—Black

**Terminals**—Bright acid-tin over copper alloy

**Screws**—#6-32 steel, zinc plating with clear chromate coating. Wire clamping screws and binding head screws available.

#### Mechanical Properties

**Pitch (Terminal Spacing)**—0.375" [9.525]

**Recommended PCB Hole Dia.**—1.8mm [.073"]

#### Electrical Properties

**Ratings**—UL Class C 20 Amps, 300V  
 UL Class D 5 Amps, 600V  
 CSA Type B 20 Amps, 300V  
 CSA Type C 20 Amps, 300V  
 CSA Type D 5 Amps, 600V  
 CSA Type E 20 Amps, 600V

**Wire Range**—12-22 AWG

#### Environmental Properties

**Operating Temperature Range**—105°C [221°F] max.

**Circuit Identification**—See page 179

#### Hardware Options

**TC9**—Safety cover, see page 174

**QC2x**—.250 Quick connects, see page 176

**QC4x**—.187 Quick connects, see page 176

**J6**—Jumpers, see page 177

**J7x**—Over-the-barrier jumpers, see page 177

**1437661-7**—Retaining clips, insulating turrets, see page 178

**1437651-2**—Wire clamp screw, steel, see page 178

**1437651-5**—Wire clamp screw, brass, see page 178

**1437651-8**—Binding head screw, steel, see page 178

**L03**—Binding head screw, stainless, see page 178

#### Ordering Information

# JC6 - P 1 07 - 06

**A**      **B**      **C**      **D**      **E**

#### **A** Series

**JC6** = Dual-Barrier, 0.375" Centers

#### **B** Terminal Style

**C** = Non Feed Thru

**E** = Extended Circ. Bd.

**F** = Quick Connect, .187

**P** = Printed Circuit Pin (available with 1, 2 Block Style)

**T** = Solder Turret

**Q** = Quick Connect, .250

**W** = Solderless Wrap

#### **C** Block Style

**1** = Flat, all positions filled

**2** = Flat, end mounting ears (required for cover option)

**3** = Insulating turret, end mounting ears with holes (required for cover option)

**4** = Insulating turret, all positions filled

**5** = Flat, open end with mounting bracket

**6** = Flat, open end, mounting bracket, insulating turret

**7** = Closed bottom, end mounting ears. (for C style terminal only)

#### **D** Screw Hardware

**05** = Brass binding combo head screws

**06** = Brass wire-clamp combo head screws

**07** = Steel binding combo head screws

**08** = Steel wire-clamp combo head screws (standard)

#### **E** No. of Circuits (Not positions)

**02** through **25**

**Note:** All part numbers are RoHS Compliant.

**0.375" [9.53] Pitch, Series JC6 (Continued)**

No. of Positions	Dim. A
2	0.325 [8.2]
2	0.375 [9.5]
3	0.750 [19.1]
4	1.125 [28.6]
5	1.500 [38.1]
6	1.875 [47.6]
7	2.250 [57.1]
8	2.625 [66.7]
9	3.000 [76.2]
10	3.375 [85.7]
11	3.750 [95.2]
12	4.125 [104.8]
13	4.500 [114.3]

No. of Positions	Dim. A
14	4.875 [123.8]
15	5.250 [133.3]
16	5.625 [142.9]
17	6.000 [152.4]
18	6.375 [161.9]
19	6.750 [171.45]
20	7.125 [180.98]
21	7.500 [190.5]
22	7.875 [200.03]
23	8.250 [209.55]
*24	8.625 [219.08]
*25	9.000 [228.60]

\* No mounting available



PRINTED CIRCUIT BOARD//MOUNTING PANEL LAYOUT

**Bend Options**

A variety of bend styles are available. Please consult Technical Support for details.



Available Block Styles: 1/2/5

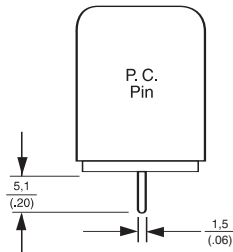

Available Block Styles: 2/3/4/5/6



Available Block Styles: 2/3/4/5/6



Available Block Styles: 2/3/4

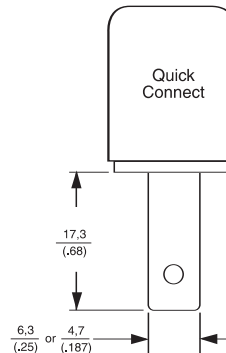

Available Block Styles: 1/2/3/4/5/6

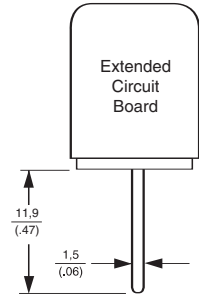

Available Block Styles: 7

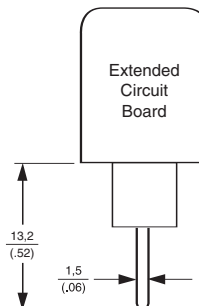
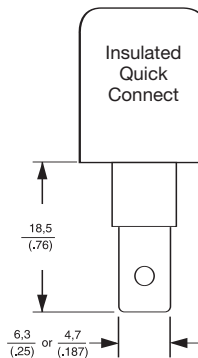
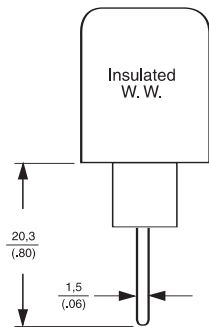

LR30811 E54800

**0.375" [9.53] Pitch, NC6 Series, Low Profile**

**NC6-P108-03**

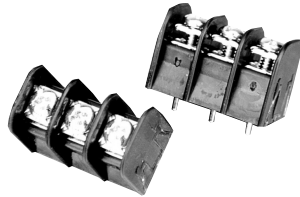

**Material & Finish**

**Housing Material**—Thermoplastic polyamide

**Flammability**—UL94V-0

**Color**—Black

**Terminals**—Bright acid tin over copper alloy

**Screws**—#6-32 steel, zinc plating with clear chromate coating. Wire clamping screws and binding head screws available.

**Mechanical Properties**

**Pitch (Terminal Spacing)**—  
.375" [9.525]

**Screw Size**—#6-32 steel

**Recommended PCB Hole Dia.**—  
1.8mm [.073"] dia.

**Electrical Properties**

**Ratings**—UL Class C 20 Amps, 300V  
CSA Type C 20 Amps, 300V

**Wire Range**—12-22 AWG

**Environmental Properties**

**Operating Temperature Range**—  
105°C [221°] max.

**Circuit Identification**—See page 179

**Hardware Options**

**1437651-2**—Wire clamp screw, steel, see page 178

**1437651-5**—Wire clamp screw, brass, see page 178

**1437651-8**—Binding head screw, steel, see page 178

**L03**—Binding head screw, stainless, see page 178

**Ordering Information**

**NC6 - P 1 08- 04**

**A B C D E**

**A Series**  
NC6 = Dual-Barrier, 0.375" Centers, Low Profile

**B Terminal Style**  
P = Printed Circuit Pin

**C Block Style**  
1 = Flat, all positions filled  
2 = End mounting holes provided

**D Screw Hardware**  
05 = Brass binding combo head screws  
06 = Brass wire-clamp combo head screws  
07 = Steel binding combo head screws  
08 = Steel wire-clamp combo head screws

**E No. of Circuits (Not positions)**  
02 through 24

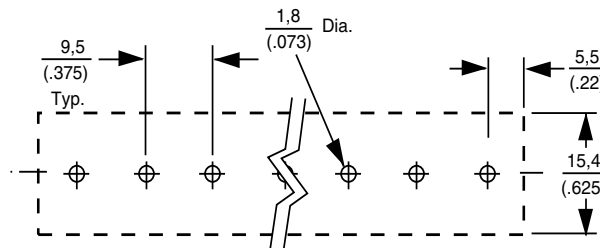

**RECOMMENDED PCB HOLE LAYOUT**

**Note:** All part numbers are RoHS Compliant.

**0.375" [9.53] Pitch, NC6 Series, Low Profile (Continued)**



No. of Positions	Dim. A
2	0.375 [9.5]
3	0.750 [19.1]
4	1.125 [28.6]
5	1.500 [38.1]
6	1.875 [47.6]
7	2.250 [57.1]
8	2.625 [66.7]
9	3.000 [76.2]
10	3.375 [85.7]
11	3.750 [95.2]
12	4.125 [104.8]
13	4.500 [114.3]

No. of Positions	Dim. A
14	4.875 [123.8]
15	5.250 [133.3]
16	5.625 [142.9]
17	6.000 [152.4]
18	6.375 [161.9]
19	6.750 [161.9]
20	7.125 [171.4]
21	7.500 [181.0]
22	7.875 [190.5]
*23	8.250 [200.0]
*24	8.625 [209.6]

\* No mounting available

**Note:** All part numbers are RoHS Compliant.

**0.4375" [11.1] Pitch, Series SSB7**

SSB7FP##0202



**Material & Finish**

- Housing Material**—Polypropylene
- Flammability**—UL94V-2
- Color**—Black
- Terminals**—Brass, bright acid tin over copper plating
- Screw**—#6-32 Steel with zinc + chromate plating

**Mechanical Properties**

- Pitch (Terminal Spacing)**—  
.4375 in. [11.1]
- Recommended PCB Hole Dia.**—  
.077" [1.955]
- Wire Strip Length**—  
.38" [9.652]
- Recommended Tightening Torque**—  
8 in.-lbs.
- Recommended Screwdrivers**—  
Stanley 1006-4, Sears Craftsman 41581, Any #2 Phillips-Head
- Wire Lug Width (Max.)**—  
8.1mm [0.320 in.]

**Electrical Properties**

- Ratings**—UL Class B 20 Amps, 600V  
UL Class C 20 Amps, 600V  
CSA Type C 20 Amps, 300V  
CSA Type D, 5 Amps, 600V

- Wire Range**—12-22 AWG
- Dielectric Withstand**—5000V

**Environmental Properties**

- Operating Temperature Range**—  
60°C to +105°C [-76°F to +221°F]

**Computing Barrier Block Lengths**

- Direct Mounting**—Use C1 and L1 for P & H mounting options
- End Position Mounting**—Use L2 and C2 for M, E, F & G mounting options



Circuits (not positions)	C1 in.	L1* in.	C2 in.	L2* in.
01	—	—	0.88	1.44
02	0.44	1.00	1.31	1.88
03	0.88	1.44	1.75	2.31
04	1.31	1.88	2.19	2.75
05	1.75	2.31	2.63	3.19
06	2.19	2.75	3.06	3.63
07	2.63	3.19	3.50	4.06
08	3.06	3.63	3.94	4.50
09	3.50	4.06	4.38	4.94
10	3.94	4.50	4.81	5.38
11	4.38	4.94	5.25	5.81
12	4.81	5.38	5.69	6.25
13	5.25	5.81	6.13	6.69
14	5.69	6.25	6.56	7.13
15	6.13	6.69	7.00	7.56
16	6.56	7.13	7.44	8.00
17	7.00	7.56	7.88	8.44
18	7.44	8.00	8.31	8.88
19	7.88	8.44	8.75	9.31
20	8.31	8.88	9.19	9.75
21	8.75	9.31	9.63	10.19
22	9.19	9.75	10.06	10.63
23	9.63	10.19	10.50	11.06
24	10.06	10.63	10.94	11.50
25	10.50	11.06	11.38	11.94
26	10.94	11.50	—	—
27	11.38	11.94	—	—



**Note:** All part numbers are RoHS Compliant.

**0.4375" [11.1] Pitch, Series SSB7 (Continued)**

**Ordering Information**

**SSB 7 F P 06 02 02 11**  
**A B C D E F G H**

**A Single Screw Dual-Barrier Strip SSB**

**B Contact Spacing (Center-to-Center)**  
 7 = .4375 (7/16)

**C Base Options**  
 C=Closed Base  
 F=Flat Base  
 R=Raised Base  
 T=Turret Base  
 (Available only with 01, 04, 05, 07, 09, 12, 13, 15 style bottom terminals)

**D Mounting Options**  
 (See illustration below)  
 E=Open end positions, with mounting inserts, with end barriers  
 F=Open end positions, without mounting inserts, without end barriers  
 G=Open end positions, with mounting inserts, without end barriers  
 M=Open end positions, without mounting inserts, with end barriers  
 P=All positions filled with contacts, with end barriers

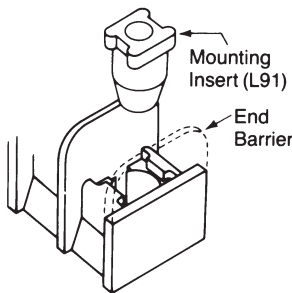

**E No. of Circuits (Not Positions)**  
 Must conform to mounting options  
**02 to 32** circuits (P & H mounting)  
**02 to 27** circuits (M, E, F & G mounting)

**F Terminal Style**  
 01=Solder Tail  
 02=Printed Circuit Pin  
 03=Non-Feed Through (with C base only)  
 04=Extended Printed Circuit Pin  
 05=Quick Connects  
 06=90° bend, .46" x .11" (with F base only)  
 07=Wire Wrap  
 08=90° bend, .75" x .11" (with F base only)  
 12=90° bend, .21" x .65"  
 13=90° bend, .36" x .50"  
 14=90° bend, .41" x .16" (with F base only)  
 15=90° bend, .51" x .35"  
 16=90° bend, .32" x .25" (with F base only)

**G Top Hardware Options**  
 00=No top hardware (Separately packaged binding head screws supplied at no cost)  
 01=Bright zinc and chromate plated steel binding head screw  
 02=Bright zinc and chromate plated steel screw and captive clamp - Do not order with other top hardware  
 03=Stainless steel binding head screw  
 04=Nickel plated brass binding head screw  
 09=Nickel plated brass screw and captive clamp - Do not order with other top hardware

80=Single-sided solder tab  
 81=Double-sided solder tab

**Quick-Connect Blades**  
 (supplied with 01 screw)

		.250 wide	.187 wide
		x.032 thick	x.020 thick
20	40		
21	41		
22	42		
23	43		
24	44		
25	45		
26	46		
27	47		
28	48		
29	49		
30	50		
31	51		
32	52		
33	53		
34	54		
35	55		
36	56		

**H Circuit Identification Options**

11	=	12345...
12	=	...54321
13	=	1 2 3 4 5 . . .
14	=	1 2 3 4 5 . . .
15	=	12345... ..
16	=	..54321

**0.4375" [11.1] Pitch, Series SSB7 (Continued)**

**Contact Spacing Options:**

**.4375 in (7/16") Spacing**

Extra thick barriers provide higher voltage rating. Up to 27 ckts. (25 circuits for end mounted blocks)

**Base Options:**

**Closed Base**

**Catalog Letter**

**Code: C.** For terminal junction-blocks requiring top connections only. Useful in applications requiring single point circuit terminations or circuit completion via top mounted, single- and two-sided quick-connects. Replace double-row barrier strips.



**Flat Base**

**Catalog Letter**

**Code: F.** Lends itself most readily to applications where direct top-to-bottom feed-through is required with no special requirement for circuit isolation on the bottom side. The most common example of this is printed circuit board mounting.



**Raised Base**

**Catalog Letter Code R.** Standoffs between each circuit raise block .030" above mounting surface to allow flux and solvents to drain during soldering operations. Available only with 02 and 04 bottom terminals.

**Turret Base**

**Catalog Letter Code: T.** Combines

top-to-bottom feed-through with bottom-side circuit isolation for panels up to .126" thick. Turret bases are available with the following terminals: solder tail, quick connect, machine wrap, extended circuit board terminal, and right-angle.



**Mounting Options:**

**End Position**

**Mounting**

**Catalog Letter**

**Codes: E, F, G or M.** Supplied without contacts in end sections to allow installer to mount blocks with screws in end section holes. Base of block will support mounting screws (Codes F & M). Also available with mounting inserts installed in end mounting holes to raise mounting screw heads to the level of other top hardware (Codes E & G).

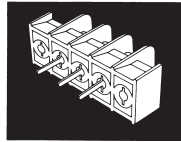

**Without End Barriers**

**Catalog Letter Codes: F, G & H.**

Facilitates mounting-screw access when end sections are used for mounting.

**Direct Mounting**

**Catalog Letter Codes: P & H.** SSBs may be solder-mounted using the bottom terminals themselves, as in the case of printed circuit board applications.

Direct mounting is also possible with turret base models using press-on retaining clips (Catalog No. L97, Part Number 1437661-7) on turrets.

**Hardware Options**

**7C1xx**—Safety cover, see page 175

**QC2x**—.250 Quick connects, see page 176

**QC4x**—.187 Quick connects, see page 176

**ST80**—Single sided solder tabs, see page 176

**1776090-x**—Extra long Quick connects, see page 176

**J7**—Jumpers, see page 177

**L91**—Mounting insert, see page 178

**L92**—Angle bracket, see page 178

**Terminal Style:**

**Solder Tail**

**Catalog Number Code: 01.** For applications requiring a wrapped solder connection.

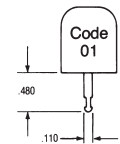

**Printed Circuit Pin**

**Catalog Number Code: 02.**

Designed specifically for mounting on .063" thick circuit board. Special, readily solderable plating permits good fillet development in automated soldering processes.

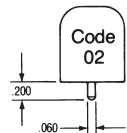

**Non-Feed-Through**

**Catalog Number Code: 03.**

With closed base option only.



**Extended Printed Circuit Pin**

**Catalog Number Code: 04.**

Useful where extra length is needed, as in thicker printed circuit boards or single-wrap connections.

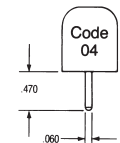

**Quick Connect**

**Catalog Number Code: 05.**

.250 in. wide x .032" thick blades accept .250" female quick connects.

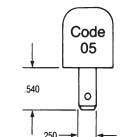

**Note:** All part numbers are RoHS Compliant.

**0.4375" [11.1] Pitch, Series SSB7 (Continued)**

**Mounting Position:  
Right-Angle**

**Catalog Number Codes: 06, 08, 12, 13, 14, 15, 16.**

Seven variations of right-angle contacts are available. Designed for circuit board and panel applications, this option saves space when printed circuit boards are stacked closely together. It provides access to top connections in restricted spaces. Mount with angle brackets. (Catalog No. L92).



Catalog No. Code	A in.	B in.
06*	0.46	0.11
08*	0.75	0.11
12	0.21	0.65
13	0.36	0.50
14*	0.41	0.16
15	0.51	0.35
16*	0.32	0.25

\*Not available with turret base

**Wire Wrap**

**Catalog Number Code: 07.**

Longer than extended circuit board terminals. Post alignment is compatible with tolerances required for automatic wire wrapping equipment. Post dimensions are compatible with standard wire wrapping bits.

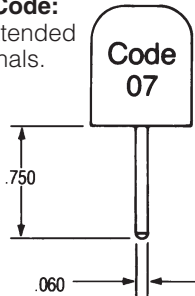

**Top Hardware Options:**

**Binding Head Screws**

In most applications, binding head screws will provide excellent wire retention because of exclusive wire locking tabs. These binding head screws are available in 3 materials identified by codes 01, 02, and 03.



**Catalog Number Code:**

- 01 Bright Zinc and Chromate Plated Steel
- 02 Stainless Steel
- 03 Nickel Plated Brass

**Captive Clamp**

For applications requiring extra security, captive clamps under the screw heads augment the locking tabs on each contact. Screws have a unique Phil-slot design accepting either Phillips-head or straight screwdriver. Code 02 screw is Bright Zinc and Chromate plated steel. Code 09 screw is Nickel plated Brass.



**Catalog Number Code:**

- 02 Bright Zinc and Chromate Plated Steel
- 09 Nickel Plated Brass

**Catalog Number Codes: 20 through 56.**

A complete selection of .187" and .250" quick-connect blades are available for connecting wire terminated with female quick connects. Single and double-sided types in flat, 45° and 90° angle bends can be supplied. Material is brass with tin plating. All blades supplied with 01 screws. Various quick-connects can be combined.

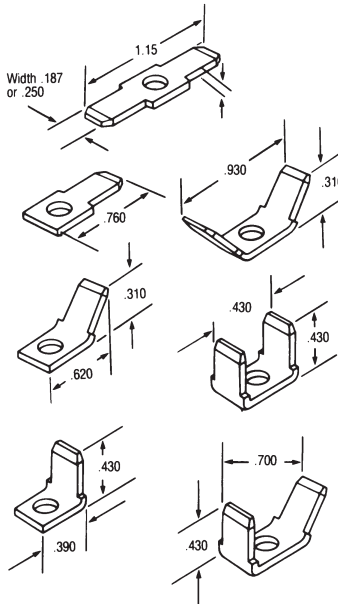

**Solder Tabs**

**Catalog Number Code: 80.** Single-sided, slotted solder tabs are available for making wrapped solder connections on the top side of SSBs.

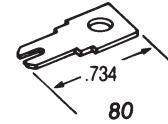

**Circuit Identification Options:**

**Catalog Number Codes: 11 through 16.**

SSB blocks may be ordered with circuit identification numbers in white on the molding in six different variations. Custom markings are available on special order.

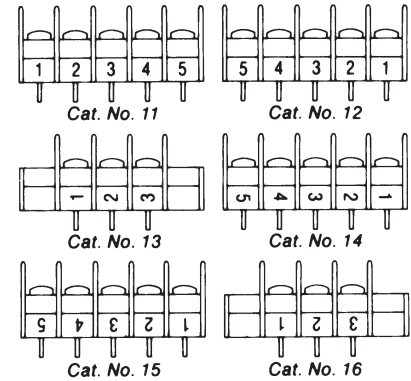

**Molding Material Options:**

The standard SSB molding material is UL94V-2 polypropylene. Consult Technical Support for other materials available on special order.

**Molding Color Options:**

SSB blocks are stocked in black. Consult Technical Support for availability of other colors.

## Double-Row, Dual-Barrier Strips

### Product Facts

- Double-row, dual barrier strips for wire-to-wire applications. These parts also allow end users to complete the wiring to a separate screw without disturbing the factory wiring.
- Available with either binding head screws or wire clamp
- Increased current-carrying capability

### Applications

- Industrial Controls
- Test Equipment
- HVAC
- Power Supplies
- Traffic Signals
- Telecom

### Key Features

- Closed bottom design allows for mounting direct to sheet metal panel
- Molded to length
- Accessories such as Quick-Connect Tabs and Jumpers available
- Wire-to-wire termination:
  - .374 [9.5] centerline:  
Up to 30 positions
  - .433 [11.0] centerline:  
Up to 26 positions
  - .437 [11.1] centerline:  
Up to 26 positions
  - .563 [14.3] centerline:  
Up to 18 positions
- RoHS Compliant



**Note:** All part numbers are RoHS Compliant.

**Double-Row, Dual-Barrier Strips (Continued)**

**.374 [9.5] Centerline**

**Material & Finish**

**Insulator Body**—UL94V-0, thermoplastic, black

**Terminals**—Brass, tin plated

**Screw**—#6-32 steel, nickel plated

**Mechanical Properties**

**Screw Torque**—12 in-lb

**Electrical Properties**

**Current Rating**—20 A, 300 VAC

**Wire Range**—12-22 AWG

**Withstanding Voltage**—2000 VAC min.

**Environmental Properties**

**Operating Temperature**—  
-40°F to +221°F [-40°C to +120°C]

**Hardware Options**

**J6140**—Spade jumper, see page 177

**J6240**—Flanged spade jumper, see page 177

**J6340**—Ring tongue jumper, see page 177

**J6**—Spade jumper, see page 177



No. of Positions	Dimension		Part Numbers	
	L	S	w/Binding Head Screws	w/Wire Clamp Screws
2	1.42 [036.2]	1.13 [028.7]	1546306-2	1546307-2
3	1.80 [045.7]	1.50 [038.2]	1546306-3	1546307-3
4	2.17 [055.2]	1.88 [047.7]	1546306-4	1546307-4
5	2.55 [064.7]	2.25 [057.2]	1546306-5	1546307-5
6	2.92 [074.2]	2.63 [066.7]	1546306-6	1546307-6
7	3.30 [083.7]	3.00 [076.2]	1546306-7	1546307-7
8	3.67 [093.2]	3.37 [085.7]	1546306-8	1546307-8
9	4.05 [103.0]	3.75 [095.2]	1546306-9	1546307-9
10	4.41 [112.0]	4.13 [105.0]	1-1546306-0	1-1546307-0
11	4.80 [122.0]	4.49 [114.0]	1-1546306-1	1-1546307-1
12	5.16 [131.0]	4.88 [124.0]	1-1546306-2	1-1546307-2
13	5.55 [141.0]	5.24 [133.0]	1-1546306-3	1-1546307-3
14	5.91 [150.0]	5.63 [143.0]	1-1546306-4	1-1546307-4
15	6.30 [160.0]	5.98 [152.0]	1-1546306-5	1-1546307-5
16	6.65 [169.0]	6.38 [162.0]	1-1546306-6	1-1546307-6
17	7.05 [179.0]	6.73 [171.0]	1-1546306-7	1-1546307-7
18	7.40 [188.0]	7.13 [181.0]	1-1546306-8	1-1546307-8
19	7.79 [198.0]	7.48 [190.0]	1-1546306-9	1-1546307-9
20	8.15 [207.0]	7.87 [200.0]	2-1546306-0	2-1546307-0
21	8.54 [217.0]	8.23 [209.0]	2-1546306-1	2-1546307-1
22	8.90 [226.0]	8.62 [219.0]	2-1546306-2	2-1546307-2
23	9.29 [236.0]	8.98 [228.0]	2-1546306-3	2-1546307-3
24	9.65 [245.0]	9.37 [238.0]	2-1546306-4	2-1546307-4
25	10.04 [255.0]	9.72 [247.0]	2-1546306-5	2-1546307-5
26	10.39 [264.0]	10.12 [257.0]	2-1546306-6	2-1546307-6
27	10.79 [274.0]	10.47 [266.0]	2-1546306-7	2-1546307-7
28	11.14 [283.0]	10.87 [276.0]	2-1546306-8	2-1546307-8
29	11.54 [293.0]	11.22 [285.0]	2-1546306-9	2-1546307-9
30	11.89 [302.0]	11.61 [295.0]	3-1546306-0	3-1546307-0

**Note:** All part numbers are RoHS Compliant.

**Double-Row, Dual-Barrier Strips** (Continued)

**.433 [11.0] Centerlines**

**Material & Finish**

**Insulator Body**—UL94V-0, thermoplastic, black

**Terminals**—Brass, tin plated

**Screw**—#6-32 steel, nickel plated

**Mechanical Properties**

**Screw Torque**—12 in-lb

**Electrical Properties**

**Current Rating**—20 A, 300 VAC

**Wire Range**—14-22 AWG

**Withstanding Voltage**—2000 VAC min.

**Environmental Properties**

**Operating Temperature**—  
-40°F to +221°F [-40°C to +120°C]



No. of Positions	Dimension		Part Numbers	
	L	S	w/Binding Head Screws	w/Wire Clamp Screws
2	1.65 [41.8]	1.264 [32.1]	1546481-2	1546477-2
3	2.08 [52.8]	1.697 [43.1]	1546481-3	1546477-3
4	2.51 [63.8]	2.130 [54.1]	1546481-4	1546477-4
5	2.94 [74.8]	2.563 [65.1]	1546481-5	1546477-5
6	3.38 [85.8]	2.996 [76.1]	1546481-6	1546477-6
7	3.81 [96.8]	3.429 [87.1]	1546481-7	1546477-7
8	4.24 [107.8]	3.862 [98.1]	1546481-8	1546477-8
9	4.68 [118.8]	4.295 [109.1]	1546481-9	1546477-9
10	5.11 [129.8]	4.728 [120.1]	1-1546481-0	1-1546477-0
11	5.54 [140.8]	5.161 [131.1]	1-1546481-1	1-1546477-1
12	5.98 [151.8]	5.594 [142.1]	1-1546481-2	1-1546477-2
13	6.41 [162.8]	6.028 [153.1]	1-1546481-3	1-1546477-3
14	6.84 [173.8]	6.461 [164.1]	1-1546481-4	1-1546477-4
15	7.27 [184.8]	6.894 [175.1]	1-1546481-5	1-1546477-5
16	7.71 [195.8]	7.327 [186.1]	1-1546481-6	1-1546477-6
17	8.14 [206.8]	7.760 [197.1]	1-1546481-7	1-1546477-7
18	8.57 [217.8]	8.193 [208.1]	1-1546481-8	1-1546477-8
19	9.01 [228.8]	8.626 [219.1]	1-1546481-9	1-1546477-9
20	9.44 [239.8]	9.059 [230.1]	2-1546481-0	2-1546477-0
21	9.87 [250.8]	9.492 [241.1]	2-1546481-1	2-1546477-1
22	10.31 [261.8]	9.925 [252.1]	2-1546481-2	2-1546477-2
23	10.74 [272.8]	10.358 [263.1]	2-1546481-3	2-1546477-3
24	11.17 [283.8]	10.791 [274.1]	2-1546481-4	2-1546477-4
25	11.61 [294.8]	11.224 [285.1]	2-1546481-5	2-1546477-5
26	12.04 [305.8]	11.657 [296.1]	2-1546481-6	2-1546477-6



**Note:** All part numbers are RoHS Compliant.

**Double-Row, Dual-Barrier Strips** (Continued)

**.437 [11.1] Centerlines**

**Material & Finish**

**Insulator Body**—UL94V-0, thermoplastic, black

**Terminals**—Brass, tin plated

**Screw**—#6-32 steel, nickel plated

**Mechanical Properties**

**Screw Torque**—12 in-lb

**Electrical Properties**

**Current Rating**—20 A, 300 VAC

**Wire Range**—14-22 AWG

**Withstanding Voltage**—2000 VAC min.

**Environmental Properties**

**Operating Temperature**—-40°F to +221°F [-40°C to +120°C]

**Hardware Options**

**1776110-x**—Single-sided Quick Connects, see page 176

**1776057-x**—Two-sided Quick Connects, see page 176

**J7**—Spade jumper, see page 177

**J7140**—Spade jumper, see page 177

**J7240**—Flanged jumper, see page 177

**J7340**—Ring tongue jumper, see page 177

**J76**—Over-the-barrier jumper, see page 177

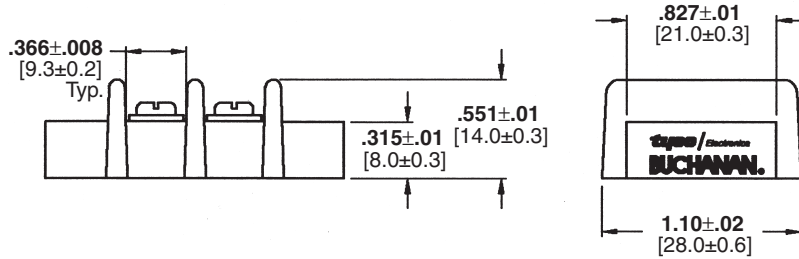

No. of Positions	Dimension		Part Numbers	
	L	S	w/Binding Head Screws	w/Wire Clamp Screws
2	1.62 [41.2]	1.264 [32.1]	1546670-2	1546671-2
3	2.06 [52.3]	1.697 [43.1]	1546670-3	1546671-3
4	2.50 [63.4]	2.130 [54.1]	1546670-4	1546671-4
5	2.93 [74.5]	2.563 [65.1]	1546670-5	1546671-5
6	3.37 [85.6]	2.996 [76.1]	1546670-6	1546671-6
7	3.81 [96.7]	3.429 [87.1]	1546670-7	1546671-7
8	4.24 [107.8]	3.862 [98.1]	1546670-8	1546671-8
9	4.68 [118.9]	4.295 [109.1]	1546670-9	1546671-9
10	5.12 [130.0]	4.728 [120.1]	1-1546670-0	1-1546671-0
11	5.55 [141.1]	5.161 [131.1]	1-1546670-1	1-1546671-1
12	5.99 [152.2]	5.594 [142.1]	1-1546670-2	1-1546671-2
13	6.43 [163.3]	6.028 [153.1]	1-1546670-3	1-1546671-3
14	6.87 [174.4]	6.461 [164.1]	1-1546670-4	1-1546671-4
15	7.30 [185.5]	6.894 [175.1]	1-1546670-5	1-1546671-5
16	7.74 [196.6]	7.327 [186.1]	1-1546670-6	1-1546671-6
17	8.18 [207.7]	7.760 [197.1]	1-1546670-7	1-1546671-7
18	8.61 [218.8]	8.193 [208.1]	1-1546670-8	1-1546671-8
19	9.05 [229.9]	8.626 [219.1]	1-1546670-9	1-1546671-9
20	9.49 [241.0]	9.059 [230.1]	2-1546670-0	2-1546671-0
21	9.93 [252.1]	9.492 [241.1]	2-1546670-1	2-1546671-1
22	10.36 [263.2]	9.925 [252.1]	2-1546670-2	2-1546671-2
23	10.80 [274.3]	10.358 [263.1]	2-1546670-3	2-1546671-3
24	11.24 [285.4]	10.791 [274.1]	2-1546670-4	2-1546671-4
25	11.67 [296.5]	11.224 [285.1]	2-1546670-5	2-1546671-5
26	12.11 [307.6]	11.657 [296.1]	2-1546670-6	2-1546671-6

**Double-Row, Dual-Barrier Strips** (Continued)

**.563 [14.3] Centerline**

**Material & Finish**

**Insulator Body**—UL94V-0, thermoplastic, black

**Terminals**—Brass, tin plated

**Screw**—M4.0 steel, nickel plated

**Mechanical Properties**

**Screw Torque**—16 in-lb

**Electrical Properties**

**Current Rating**—30 A, 300 VAC

**Wire Range**—10-22 AWG

**Withstanding Voltage**—2000 VAC min.

**Environmental Properties**

**Operating Temperature**—-40°F to +284°F [-40°C to +140°C]

**Hardware Options**

**1776174-x**—Single-sided Quick Connects, see page 176

**1776173-x**—Two-sided Quick Connects, see page 176



No. of Positions	Dimension		Part Numbers	
	L	S	w/Wire Clamp Screws	w/Binding Head Screws
2	2.13 [54.0]	1.69 [42.9]	1546311-2	1546310-2
3	2.69 [68.3]	2.25 [57.2]	1546311-3	1546310-3
4	3.25 [82.6]	2.81 [71.5]	1546311-4	1546310-4
5	3.81 [96.9]	3.38 [85.8]	1546311-5	1546310-5
6	4.38 [111.2]	3.94 [100.1]	1546311-6	1546310-6
7	4.94 [125.5]	4.50 [114.4]	1546311-7	1546310-7
8	5.50 [139.8]	5.07 [128.7]	1546311-8	1546310-8
9	6.08 [154.1]	5.63 [143.0]	1546311-9	1546310-9
10	6.63 [168.4]	6.19 [157.3]	1-1546311-0	1-1546310-0
11	7.19 [182.7]	6.76 [171.6]	1-1546311-1	1-1546310-1
12	7.75 [197.0]	7.32 [185.9]	1-1546311-2	1-1546310-2
13	8.32 [211.3]	7.88 [200.2]	1-1546311-3	1-1546310-3
14	8.88 [225.6]	8.44 [214.5]	1-1546311-4	1-1546310-4
15	9.44 [239.9]	9.01 [228.8]	1-1546311-5	1-1546310-5
16	10.02 [254.5]	9.57 [243.1]	1-1546311-6	1-1546310-6
17	10.57 [268.5]	10.13 [257.4]	1-1546311-7	1-1546311-7
18	11.13 [282.8]	10.70 [271.7]	1-1546311-8	1-1546310-8



**Note:** All part numbers are RoHS Compliant.

**Double-Row, Dual-Barrier Strips w/o Washer**

**.563 [14.3] Centerline**

**Material & Finish**

**Insulator Body**—UL94V-0, thermoplastic, black

**Terminals**—Brass, tin plated

**Screw**—M4.0 steel, nickel plated

**Mechanical Properties**

**Screw Torque**—14 in-lb

**Electrical Properties**

**Current Rating**—30 A, 600 VAC

**Wire Range**—10-22 AWG

**Withstanding Voltage**—2000 VAC min.

**Environmental Properties**

**Operating Temperature**—-40°F to +120°F [-40°C to +49°C]

**Hardware Options**

**1776174-x**—Single-sided Quick Connects, see page 176

**1776173-x**—Two-sided Quick Connects, see page 176

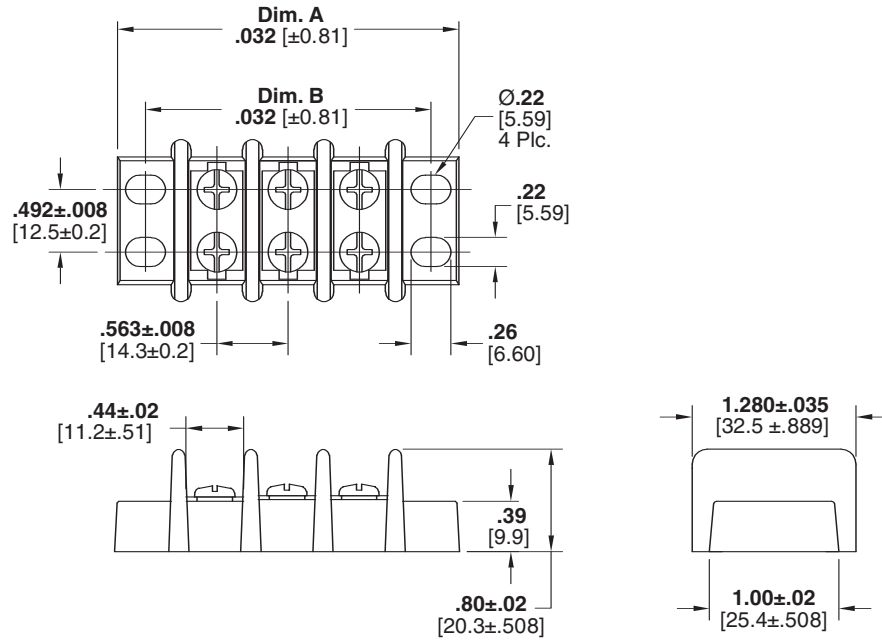

No. of Positions	Dimension		Part Numbers	
	L	S	w/Wire Clamp Screws	w/Binding Head Screws
2	2.13 [54.0]	1.69 [42.9]	1776544-2	1986158-2
3	2.69 [68.3]	2.25 [57.2]	1776544-3	1986158-3
4	3.25 [82.6]	2.81 [71.5]	1776544-4	1986158-4
5	3.81 [96.9]	3.38 [85.8]	1776544-5	1986158-5
6	4.38 [111.2]	3.94 [100.1]	1776544-6	1986158-6
7	4.94 [125.5]	4.50 [114.4]	1776544-7	1986158-7
8	5.50 [139.8]	5.07 [128.7]	1776544-8	1986158-8
9	6.08 [154.1]	5.63 [143.0]	1776544-9	1986158-9
10	6.63 [168.4]	6.19 [157.3]	1-176544-0	1-1986158-0
11	7.19 [182.7]	6.76 [171.6]	1-176544-1	1-1986158-1
12	7.75 [197.0]	7.32 [185.9]	1-176544-2	1-1986158-2
13	8.32 [211.3]	7.88 [200.2]	1-176544-3	1-1986158-3
14	8.88 [225.6]	8.44 [214.5]	1-176544-4	1-1986158-4
15	9.44 [239.9]	9.01 [228.8]	1-176544-5	1-1986158-5
16	10.02 [254.5]	9.57 [243.1]	1-176544-6	1-1986158-6
17	10.57 [268.5]	10.13 [257.4]	1-176544-7	1-1986158-7
18	11.13 [282.8]	10.70 [271.7]	1-176544-8	1-1986158-8

## Barrier Strip Sockets

Mateability for the socket line is given below:

Socket Series	Connector Series
USB	RSB3, SSB3
RSB6B	RSB6

### Product Facts

- n End-to-end mounting of USB sockets maintain circuit spacing: Two 12-circuit USB sockets can mate with one 24-circuit SSB3 or RSB3.
- n Secure mating with built-in locking arms



This unique plug-in socket line allows quick connection of circuits simultaneously without the use of tools.

They are designed to be wave-soldered to a PC board, after which the connector is plugged into the socket.

**Note:** All part numbers are RoHS Compliant.

**0.325" [8.26] Pitch, Series USB Socket (for Series RSB3 and SSB3)**

**USB3B08S & SSB3FP080202**

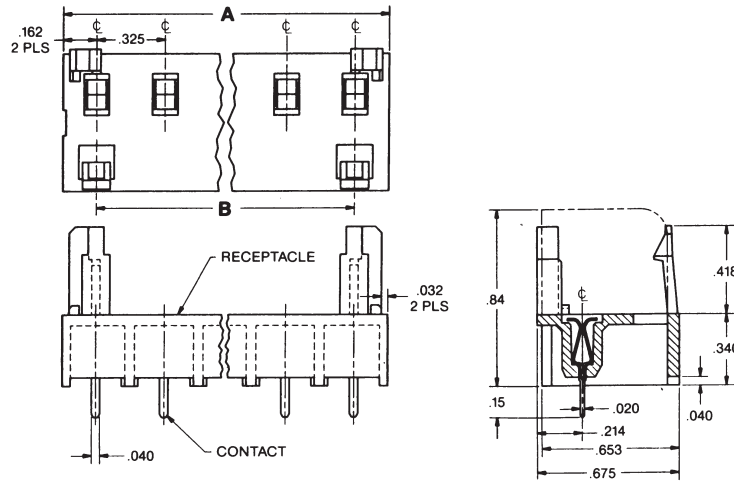

**Material & Finish**

**Housing Material**—Polyamide, Type 6/6

**Flammability**—UL94V-2

**Color**—Black

**Terminals Contact**—Copper alloy, bright tin plating

**Pin**—Copper alloy, bright tin plating

**Mechanical Properties**

**Pitch (Terminal Spacing)**—0.325" [8.26]

**Recommended PCB Hole Dia.**—.055" [1.40]

**Pullout Force**—5-7 lbs.

**Electrical Properties**

**Ratings**—UL Class B 10 Amps, 300V  
CSA Type B 15 Amps, 300V  
CSA Type D 10 Amps, 300V

**Dielectric Withstand**—3500V

**Environmental Properties**

**Operating Temperature Range**—-60°C to +105°C [-76°F to +221°F]

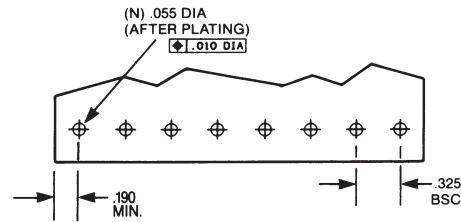

**Recommended PCB Hole Pattern**

No. of Circuits	Dimensions		Dual-Barrier Mating Strip Catalog Number	Tri-Barrier Mating Strip Catalog Number	Catalog Number
	A	B			
2	0.650	0.325	SSB3FP0202...	RSB3VP0212...	USB3B02S
3	0.975	0.650	SSB3FP0302...	RSB3VP0312...	USB3B03S
4	1.300	0.975	SSB3FP0402...	RSB3VP0412...	USB3B04S
5	1.625	1.300	SSB3FP0502...	RSB3VP0512...	USB3B05S
6	1.950	1.625	SSB3FP0602...	RSB3VP0612...	USB3B06S
7	2.275	1.950	SSB3FP0702...	RSB3VP0712...	USB3B07S
8	2.600	2.275	SSB3FP0802...	RSB3VP0812...	USB3B08S
9	2.925	2.600	SSB3FP0902...	RSB3VP0912...	USB3B09S
10	3.250	2.925	SSB3FP1002...	RSB3VP1012...	USB3B10S
11	3.575	3.250	SSB3FP1102...	RSB3VP1112...	USB3B11S
12	3.900	3.575	SSB3FP1202...	RSB3VP1212...	USB3B12S
13	4.225	3.900	SSB3FP1302...	RSB3VP1312...	USB3B13S
14	4.550	4.225	SSB3FP1402...	RSB3VP1412...	USB3B14S

**Note:** See page 165 to complete mating Tri-Barrier Strip Catalog Number.  
See page 169 to complete mating Dual-Barrier Strip Catalog Number.



**Note:** All part numbers are RoHS Compliant.

**0.375" [9.53] Pitch, Series RSB6B Socket (for Series RSB6 Tri-Barrier)**

**RSB6B06S**



**Material & Finish**

- Housing Material**—Polyamide
- Flammability**—UL94V-2
- Color**—Black
- Terminals**—Copper alloy, bright tin plating
- Pin**—Copper alloy, bright tin plating

**Mechanical Properties**

- Pitch (Terminal Spacing)**—  
.375 in [9.53]
- Recommended PCB Hole Dia.**—  
.062" [1.57]

**Electrical Properties**

- Ratings**—UL Class B 20 Amps, 300V  
CSA Type B 10 Amps, 300V  
CSA Type D 5 Amps, 600V
- Dielectric Withstand**—3500V

**Environmental Properties**

- Operating Temperature Range**—  
-60°C to +105°C [-76°F to +221°F]

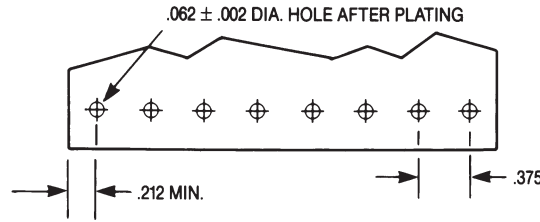
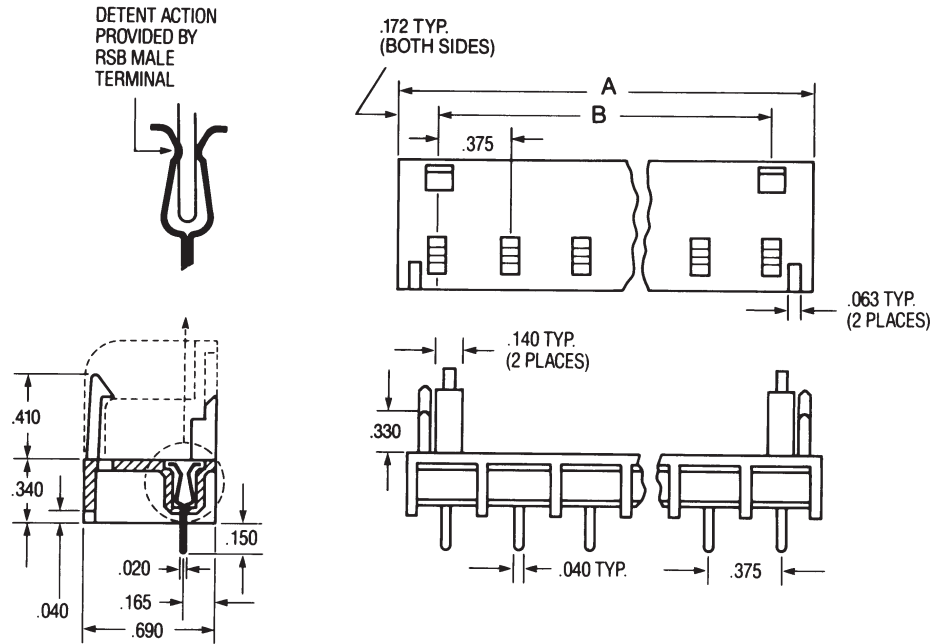

**Recommended PCB Hole Pattern**

No. of Circuits	Dimensions		Catalog Number
	A	B	
02	0.720	0.375	RSB6B02S
03	1.094	0.750	RSB6B03S
04	1.469	1.125	RSB6B04S
05	1.844	1.500	RSB6B05S
06	2.219	1.875	RSB6B06S
07	2.594	2.250	RSB6B07S
08	2.869	2.625	RSB6B08S
09	3.244	3.000	RSB6B09S
10	3.720	3.375	RSB6B10S

**Note:** RSB6 Tri-Barrier Blocks should be ordered with Number 12 Terminal Style (printed circuit pin, V mounting) when used in combination with this plug-in socket. See page 172 for ordering information.

**Note:** All part numbers are RoHS Compliant.

**0.325" [8.26] Pitch, Series RSB3**

**RSB3VP061202**



**Material & Finish**

- Housing Material**—Polypropylene
- Flammability**—UL94V-2
- Color**—Black
- Terminals**—Brass w/bright Tin plating
- Screws**—Steel w/Zinc + Chromate plating

**Mechanical Properties**

- Pitch (Terminal Spacing)**—  
.325 in [8.26]
- Screw Size**—6-32
- Recommended PCB Hole Dia.**—  
0.062"
- Wire Strip Length**—  
.31 in [7.87]
- Recommended Tightening Torque**—  
9 in-lbs.
- Recommended Screwdrivers**—  
Stanley 1006-4, Sears Craftsman 41581, Any #2 Phillips-Head
- Wire Lug Width (Max.)**—  
.265 in [6.73]

**Electrical Properties**

- Maximum Current**—15A
- Operating Voltage**—300V
- Wire Range**—#14-26 AWG
- Dielectric Withstand**—4000V

**Environmental Properties**

- Operating Temperature Range**—  
-60°C to +105°C [-76°F to +221°F]
- For mating socket, see pg. 162.

**Computing Barrier Block Lengths**

- Direct Mounting**—Use C1 and L1 for Mounting Option "P".
- End Position Mounting**—Use C2 and L2 for Mounting Option "M".

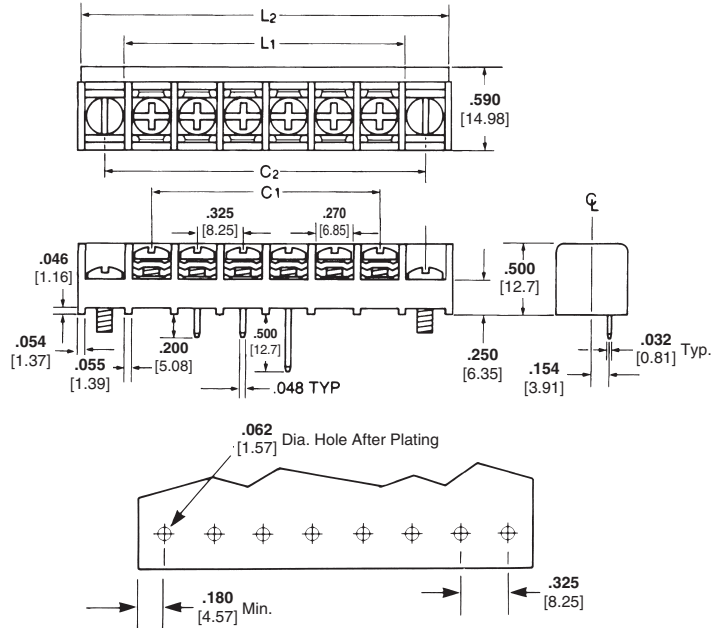

**Dimensions**

Circuits (not positions)	C1 in.	L1* in.	C2 in.	L2* in.
02	0.325	0.704	0.975	1.354
03	0.650	1.029	1.300	1.679
04	0.975	1.354	1.625	2.004
05	1.300	1.679	1.950	2.329
06	1.625	2.004	2.275	2.654
07	1.950	2.329	2.600	2.979
08	2.275	2.654	2.925	3.304
09	2.600	2.797	3.250	3.629
10	2.925	3.304	3.575	3.954
11	3.250	3.629	3.900	4.279
12	3.575	3.954	4.225	4.604
13	3.900	4.279	4.550	4.929
14	4.225	4.604	4.875	5.254
16	4.875	5.254	5.525	5.904
17	5.200	5.579	5.850	6.229
18	5.525	5.904	6.175	7.554
19	5.850	6.229	6.500	6.879
20	6.175	6.554	6.825	7.204
21	6.500	6.879	7.150	7.529
22	6.825	7.204	7.475	7.854
23	7.150	7.529	7.800	8.179
24	7.475	7.854	8.125	8.504
25	7.800	8.179	8.450	8.829
26	8.125	8.504	8.775	9.154
27	8.450	8.829	9.100	9.479
28	8.775	9.154	9.425	9.804
29	9.100	9.479	9.750	10.129
30	9.425	9.804	10.075	10.454
31	9.750	10.129	10.400	10.779
32	10.075	10.454	10.725	11.104
33	10.400	10.779	11.050	11.429
34	10.725	11.104	11.357	11.754
35	11.050	11.429	—	—
36	11.357	11.754	—	—

\*L2 and L1 are based on molded-to-length strips.



**Note:** All part numbers are RoHS Compliant.

**0.325" [8.26] Pitch, Series RSB3 (Continued)**

**Ordering Information**

**RSB   3   V   P   06   12   02   11**  
**A            B            C            D            E            F            G            H**

**A Single Screw Tri-Barrier Strip RSB**



**B Contact Spacing (Center-to-Center)**  
 3=.325 in.

**C Mounting Position**  
 V=Vertical Mounting



**D End Contact Mounting Options**  
**M**=End Position Mounting: open end positions with barriers.  
**P**=Direct Mounting: all positions filled with contacts, with barriers

**E No. of Circuits (Not Positions)**  
**02** through **34** for M Option  
**02** through **36** for P Option

**F Terminal Style**  
**12**=Printed Circuit Pin for use with USB3 Series Socket  
**15**=Superseded by 4 PCR per page 125  
**17**=Superseded by 4WWV, page 125

**G Top Hardware Options**  
**01**=Bright zinc and chromate plated steel binding-head screw  
  
**02**=Bright zinc and chromate plated steel screw and captive clamp – Do not order in combination with other top hardware.  

**Quick-Connect Blades**  
 (supplied with 01 screw)

.110 wide		.187 wide	
x.020 thick		x.020 thick	
13	73=		
14	74=		
15	75=		

**Catalog Number Codes:** 13 through 15 and 73 through 75. A complete selection of .187" and .110" quick-connect blades for connecting wire terminated with female quick connects. Single-sided types in flat, 45° and 90° angle bends can be supplied. Material is brass with tin plating. All blades supplied with 01 screws. Various quick-connects can be combined.



**H Circuit Identification Options**  
 Catalog Number Codes: 11 through 18 and 21 through 28. RSB3 blocks may be ordered with white circuit identification numbers on the molding in 16 variations. Custom markings available on special order.

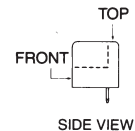

For mating socket, see pg. 162.



Barrier Strips  
2

**Note:** All part numbers are RoHS Compliant.

**0.325" [8.26] Pitch, Series RSB3 (Continued)**

**Mounting Position**

**Vertical Mounting**

**Catalog Letter Code: V.** Used where direct top-to-bottom feed-through is required with no need for circuit isolation on the bottom side. The most common example of this is printed circuit board mounting.



**End Contact Mounting Options**

**End Position Mounting**

**Catalog Letter Code: M.** Supplied without contact in end sections to allow installer to mount blocks with screws in end section holes. Base of block will support #6 mounting screws.



**Direct Mounting**

**Catalog Letter Code: P.** RSB3 may be solder-mounted using the bottom terminals themselves, as in the case of printed circuit board applications.



**Terminal Style**

**Printed Circuit Pin**

**Catalog Number Code: 12.** Designed specifically for use with our USB3 socket, page 162

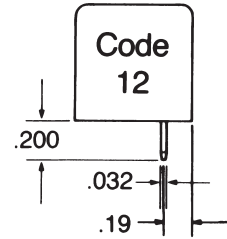

**Hardware Options**

- 3C1xxx**—Safety cover, see page 175
- J3140**—Jumpers, see page 177
- 3L02**—Wire clamp screw, see page 178
- 3L01**—Binding head screw, see page 178



**Note:** All part numbers  
are RoHS Compliant.

---

## Engineering Notes

---





**Note:** All part numbers are RoHS Compliant.

**0.325" [8.26] Pitch, Series SSB3**

**SSB3FP##0202**



**Material & Finish**

- Housing Material**—Polypropylene
- Flammability**—UL94V-2
- Color**—Black
- Terminals**—Brass, bright acid tin over copper plating
- Screw**—Steel w/ Zinc + Chromate plating

**Mechanical Properties**

- Pitch (Terminal Spacing)**—.325" [8.26]
- Screw Size**—6-32
- Recommended PCB Hole Dia.**—.062" [1.57]
- Wire Strip Length**—.31" [7.87]
- Recommended Tightening Torque**—9 in.-lbs.
- Recommended Screwdrivers**—Stanley 1006-4, Sears Craftsman 41581, Any #2 Phillips Head.
- Wire Lug Width (Max.)**—.265" [6.73]

**Electrical Properties**

- Ratings**—UL Class B 20 Amps, 300V  
UL Class C 20 Amps, 300V  
UL Class D 10 Amps, 300V  
CSA Type B 10 Amps, 300V  
CSA Type D 10 Amps, 300V

- Wire Range**—#14-26 AWG
- Dielectric Withstand**—4500V

**Environmental Properties**

- Operating Temperature Range**—60°C to +105°C [-76°F to +221°F]

**Computing Barrier Block Lengths**

- Direct Mounting**—Use C1 & L1 for Mounting Option "P".
- End Position Mounting**—Use C2 & L2 for Mounting Options "F" and "M".

For mating socket, see pg. 162.

**Dimensions**

Circuits (not positions)	C1 in.	L1* in.	C2 in.	L2* in.
02	0.325	0.704	0.975	1.354
03	0.650	1.029	1.300	1.679
04	0.975	1.354	1.625	2.004
05	1.300	1.679	1.950	2.329
06	1.625	2.004	2.275	2.654
07	1.950	2.329	2.600	2.979
08	2.275	2.654	2.925	3.304
09	2.600	2.979	3.250	3.629
10	2.925	3.304	3.575	3.954
11	3.250	3.629	3.900	4.279
12	3.575	3.954	4.225	4.604
13	3.900	4.279	4.550	4.929
14	4.225	4.604	4.875	5.254
15	4.550	4.949	5.200	5.579
16	4.875	5.254	5.525	5.579
17	5.200	5.579	5.850	6.229
18	5.525	5.904	6.175	7.554
19	5.850	6.229	6.500	6.879
20	6.2175	6.554	6.825	7.204
21	6.500	6.879	7.150	7.529
22	6.825	7.204	7.475	7.854
23	7.150	7.529	7.800	8.179
24	7.475	7.854	8.125	8.504
25	7.800	8.179	8.450	8.829
26	8.125	8.504	8.775	9.154
27	8.450	8.829	9.100	9.479
28	8.775	9.154	9.425	9.804
29	9.100	9.479	9.750	10.129
30	9.425	9.804	10.075	10.454
31	9.750	10.129	10.400	10.779
32	10.075	10.454	10.725	11.104
33	10.400	10.779	11.050	11.429
34	10.725	11.104	11.375	11.754
35	11.050	11.429	—	—
36	11.375	11.754	—	—



EC/98/003-01 12241/CL LR25557 E63810

**Note:** All part numbers are RoHS Compliant.

**0.325" [8.26] Pitch, Series SSB3 (Continued)**

**Ordering Information**

**SSB 3 F P 06 02 02 Suffix**  
**A B C D E F G H**

**A Single Screw Dual-Barrier Strip SSB**

**B Contact Spacing**  
(Center-to-Center)  
3=.325 in.

**C Base**  
F=Raised Base

**D Mounting Options**  
F= Open end positions without end barriers  
M= Open end positions with end barriers  
P= All positions filled with contacts, with end barriers

**E No. of Circuits (Not Positions)**  
02 through 36

**F Terminal Style**  
02= Printed Circuit Pin  
04= Extended Circuit Board  
11= Right-Angle Bend .18 x .12

**G Top Hardware Options**  
01= Bright zinc and chromate plated steel binding-head screw



02= Bright zinc and chromate plated steel screw and captive clamp - Do not order in combination with other top hardware.



**Quick-Connect Blades**  
(supplied with 01 screw)

	.110 wide	.187 wide
	x.020	x.020
	thick	thick
	10	70=
	11	71=
	12	72=
	13	73=
	14	74=
	15	75=

**H Circuit Identification Options**  
Catalog Number Codes: 11 through 16. SSB blocks may be ordered with circuit identification numbers in white on the molding in six different variations. Custom markings are available on special order.

11	= 12345...
12	= ...54321
13	=
14	=
15	=
16	=

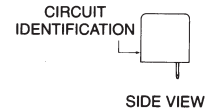
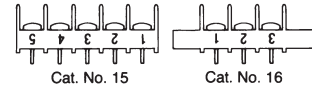
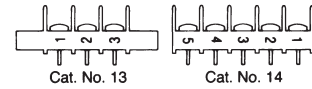
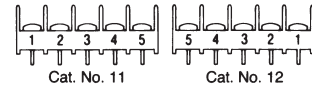

**Hardware Options**

- 3C1xxx**—Safety cover, see page 175
- J3140**—Jumpers, see page 177
- 3L02**—Wire clamp screw, see page 178
- 3L01**—Binding head screw, see page 178
- QC1x**—.110 Quick connects, see page 176
- QC7x**—.187 Quick connects, see page 176

For mating socket, see pg. 162.



Barrier Strips  
**2**

**Note:** All part numbers are RoHS Compliant.

**0.325" [8.26] Pitch, Series SSB3, Options**

**Base**

**Catalog Letter Code: F.** Lends itself most readily to applications where direct top-to-bottom feed-through is required with no special requirement for circuit isolation on the bottom side. The most common example of this is printed circuit board mounting.



**Mounting Options**

**End Position Mounting**

**Catalog Letter Code: M.** Provides a printed circuit board mounting option with top-side wire entry.



**End Position Mounting Without Barriers**

**Catalog Letter Code: F.** Facilitates mounting-screw access when end sections are used for mounting.



**Direct Mounting:**

**Catalog Letter Code: P.** SSBs may be solder-mounted using the bottom terminals themselves, as in the case of printed circuit board applications.



**Printed Circuit Pin:**

**Catalog Number Code: 02.**

Designed specifically for mounting on .063" thick circuit board. Special, readily solderable plating permits good fillet development in automated soldering processes.



**Extended Printed Circuit Pin:**

**Catalog Number Code: 04.** Useful where extra length is needed, as in thicker printed circuit boards or single-wrap connections.

**Quick Connects**

**Catalog Number Codes: 10 through 75.**

A complete selection of .187" and .110" quick-connect blades are available for connecting wire terminated with female quick connects. Single- and double-sided types in flat, 45° and 90° angle bends can be supplied. Material is brass with tin plating. All blades supplied with O1 screws. Various quick-connects can be combined.

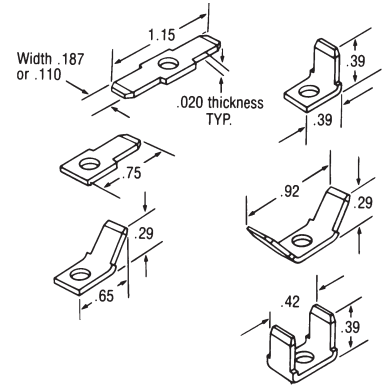

**Top Hardware Options**

**Binding Head Screws**

**Catalog Number Code: 01.** In most applications, binding head screws will provide excellent wire retention because of exclusive wire locking tabs. Screws are bright zinc and chromate plated steel.



**Captive Clamp**

**Catalog Number Code: 02.**

For applications requiring extra security, captive clamps under the screw heads augment the locking tabs on each contact. Screws have a unique Phil-slot design accepting either Phillips-head or straight screwdriver. Code 02 screw is bright zinc and chromate plated steel.



**Note:** All part numbers are RoHS Compliant.

**0.375" [9.53] Pitch, Series RSB6**

**RSB6RP##1102**

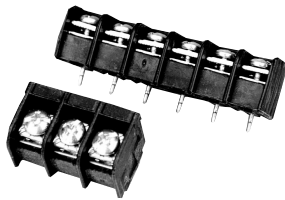

**Material & Finish**

- Housing Material**—Polypropylene
- Flammability**—UL94V-2
- Color**—Black
- Terminals**—Brass, bright acid tin over copper plating
- Screw**—Steel w/Zinc + Chromate plating

**Mechanical Properties**

**Pitch (Terminal Spacing)**—  
.375" [9.53]

**Screw Size**—6-32

**Recommended PCB Hole Dia.**—  
.062" [1.57]

**Wire Strip Length**—  
.38" [9.65]

**Recommended Tightening**

**Torque**—12 in.-lbs.

**Recommended Screwdrivers**—  
Stanley 1006-4, Sears Craftsman 41581,  
Any #2 Phillips-Head

**Wire Lug Width (Max.)**—8.1mm  
[.320"]

**Electrical Properties**

**Ratings**—UL Class B 20 Amps, 300V  
CSA Type C 15 Amps, 150V  
CSA Type D 10 Amps, 300V

**Wire Range**—12-22 AWG

**Dielectric Withstand**—3500V

**Environmental Properties**

**Operating Temperature Range**—  
60°C to +105°C [-76°F to +221°F]

**Computing RSB Block Lengths**

**Direct Mounting** – Use C1 & L1 for  
VP, SP, RP mounting options

**End Position Mounting** – Use L2 &  
C2 for VM, SM, RM, VE, SE, RE  
mounting options

For mating socket, see pg. 163.

**Hardware Options**

**J6**—Jumpers, see page 177

**L02**—Wire clamp screw, steel,  
see page 178

**L09**—Wire clamp screw, brass,  
see page 178

**L01**—Binding head screw,  
see page 178

**L04**—Binding head screw, brass,  
see page 178

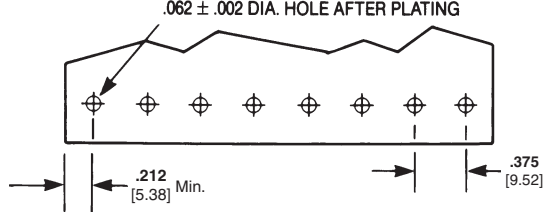

**Dimensions**

Circuits (not positions)	C1 in.	L1* in.	C2 in.	L2* in.
01	—	—	0.75	1.22
02	0.37	0.84	1.13	1.59
03	0.75	1.22	1.50	1.97
04	1.13	1.59	1.88	2.34
05	1.50	1.97	2.25	2.72
06	1.88	2.34	2.63	3.09
07	2.25	2.72	3.00	3.47
08	2.63	3.09	3.37	3.84
09	3.00	3.47	3.75	3.84
10	3.37	3.84	4.13	4.59
11	3.75	4.22	4.50	4.97
12	4.13	4.59	4.88	5.34
13	4.50	4.97	5.25	5.72
14	4.88	5.34	5.63	6.09
15	5.25	5.72	6.00	6.47
16	5.63	6.09	6.38	6.84
17	6.00	6.47	6.75	7.22
18	6.38	6.84	7.13	7.59
19	6.75	7.22	7.50	7.97
20	7.13	7.59	7.88	8.34
21	7.50	7.97	8.25	8.72
22	7.88	8.34	8.63	9.09
23	8.25	8.72	9.00	9.47
24	8.63	9.09	9.75	9.84
25	9.00	9.47	9.75	10.22
26	9.38	9.84	10.13	10.59
27	9.75	10.22	10.50	10.97
28	10.13	10.59	10.88	11.34
29	10.50	10.97	11.25	11.72
30	10.88	11.34	11.63	12.09
31	11.25	11.72	12.00	12.47
32	11.63	12.09	12.38	12.84
33	12.00	12.47	12.75	13.22
34	12.38	12.84	13.13	13.59
35	12.75	13.22	13.50	13.97
36	13.13	13.59	13.88	14.34

**Note:** All part numbers are RoHS Compliant.

**0.375" [9.56] Pitch, Series RSB6 (Continued)**

**Ordering Information**

**RSB   6   R   P   07   12   02   11**  
**A   B   C   D   E   F   G   H**

**A Single Screw Tri-Barrier Strips RSB**

**B Contact Spacing**  
**6**=.375 in. (6/16)

**C Mounting Position Options**  
**V**= Vertical Mounting  
**H**= High Rise (use with #18 terminal style)

**D End Contact Options**  
**E**= Open end pos. with mounting inserts  
**M**= Open end positions  
**P**= All positions filled with contacts

**E No. of Circuits (Not Positions)**  
**02** through **34** for M Option  
**02** through **36** for P Option

**F Terminal Style**  
**11**=Superseded by 6STV, page 129  
**12**=Circuit Board, V Mounting (select this option when block is to be used with RSB plug-in socket)  
**13**=Superseded by 6TBV, page 129  
**14**=Superseded by 6STR, page 129  
**15**=Superseded by 6PCR, page 129  
**16**=Superseded by 6WWR, page 129  
**17**=Superseded by 6WWV, page 129  
**18**=Circuit Board (for High Rise Mounting)

**G Top Hardware Options**  
**01**=  
 Bright zinc and chromate plated steel binding-head screw  
**02**=  
 Bright zinc and chromate steel screw and captive clamp – Do not order in combination with other top hardware  
**03**=Stainless steel binding-head screw  
**04**=Nickel plated brass binding-head screw  
**09**=Nickel plated brass screw and captive clamp – Do not order in combination with other top hardware

**Quick-Connect Blades**  
 (supplied with 01 screw)

		.250 [6.35] wide	.187 [4.75] wide
		x.032 [.81]	x.020 [.51]
		thick	thick
22	42	=	⊥
23	43	=	⊥
24	44	=	⊥
25	45	=	⊥
29	49	=	⊥
30	50	=	⊥
31	51	=	⊥
33	53	=	⊥
35	55	=	⊥
36	56	=	⊥

**H Circuit Identification Options**  
 Request drawing C7013624 for complete information

Front	Top
<b>11</b>	<b>21</b> = 12345...
<b>12</b>	<b>22</b> = ...54321
<b>13</b>	<b>23</b> = 1 2 3 4 5 . . .
<b>14</b>	<b>24</b> = . . . 5 4 3 2 1
<b>15</b>	<b>25</b> = 12345... 12345...
<b>16</b>	<b>26</b> = ...54321... 54321...
<b>17</b>	<b>27</b> = 1 2 3 4 5 . . .
<b>18</b>	<b>28</b> = . . . 5 4 3 2 1

For mating socket, see pg. 152.



**Note:** All part numbers are RoHS Compliant.

**0.375" [9.56] Pitch, Series RSB6, Features/Options**

**Terminal Style**

**Vertical Terminal**

**Catalog Number Code 12:** Designed specifically for use with our RSB6B Socket, page 163.



**Mounting & Contact Position Options**

**Vertical, Direct Mounting**

**Catalog Code VP:** This configuration is frequently used on printed circuit boards where solder connections are used to fasten the block to the board.



**Vertical, End Position Mounting**

**Catalog Code VM:**

Used where end sections are needed for mounting. Thickness of base is sufficient to support mounting screws.



**High Rise, All Positions Filled with Contacts**

**Catalog Code HP:**

Designed for high density; two rows deep when used in conjunction with a VP configuration.



**Top Hardware Options:**

**Binding Head Screws**

Four Styles Available.



**Captive Clamp**

**Catalog Number Code: 02 & 09.**

For applications requiring extra security, captive clamps under the screw heads augment the locking tabs on each contact. Screws have #8 pan head with a unique Phil-slot design accepting either Phillips-head or straight screwdriver. The body is #6 to allow use of larger wire.



**Quick Connects**

**Catalog Code below:** A selection of .187" and .250" quick connect blades with tin plated brass are available for connecting wire terminated with female quick-connects. They are available individually or in combination. See ordering information.



**High Rise, Mounting Standoffs**

Designed for high density; allows two rows of contacts on two levels when used with a VP mounting configuration.



Barrier Strips  
2



**Note:** All part numbers are RoHS Compliant.

**Accessories — Barrier Strip Safety Covers**

**For Series BC6, #3, JC6**



**For Series BC6, #3, JC6 Mounting**

**TC 3**—Aluminum mounting bushings and screws

**TC 2, 9**—Plastic fasteners attached to block with thru-bolts and nuts (not supplied)

**Center Spacing**

**TC 3**—0.250 inch [6.35]

**TC 2, 9**—0.375 inch [9.56]

**Material**—Clear, rigid PVC, UL94V-0

**For Series #4, #6, #8 Physical Properties**

**Centerline spacing**—8.2/[.325] - 9.5/[.375] 11.1/[.4375]

**Positions**—2 thru 16, molded to length

**Material**—Black, thermoplastic, UL94V-0

**Shock and Vibration**—to MIL.STD. 1344 method 2005.1 Condition III.



**For Series #4, #6, #8**



**Ordering Information**

**TC 4 - 06 - PFH - CL**

**A B C D E**

**A Series**  
TC = Cover

**B Center Spacing**  
2 = BC6 Series  
3 = #3 Series  
4 = #4 Series  
6 = #6 Series  
8 = #8 Series  
9 = JC6 Series

**C No. of Circuits**  
(Not positions)  
02 through 24 for Series BC6, JC6  
02 through 30 for Series #3  
02 through 16 for Series #4, #6, #8

**D Access Holes**  
PF\* = Press Fit without holes  
PFH\* = Press Fit with holes  
AG = Adder for Series BC6, #3, JC6  
**E Color** (add for Series #4, #6, #8 only)  
(blank) = Black (Series BC6, #3, JC6 are clear)  
CL = Translucent (Available only for Series #4, #6, #8)

Overall Height (O.H.)		
TC2	TC3	TC9
0.970"	0.650"	0.970"

\* Add for Series #4, #6, #8

Catalog #	A	B	C	D Ref.	L
TC4	8,2 (.325)	6,0 (.238)	13,5 (.531)	5,7 (.225)	A* (N-1)+7,9/(.312) #4
TC6	9,5 (.375)	6,3 (.250)	13,3 (.525)	6,4 (.253)	A* (N-1)+4/(.370) #6
TC8	11,1 (.4375)	8,1 (.314)	21,5 (.846)	11,1 (.4375)	A* (N-1)+10,9/(.430) #8

**Note:** All part numbers are RoHS Compliant.

**Accessories — Barrier Strip Safety Covers** (Continued)

**Safety Covers**

Dead front protection designed to prevent accidental contact with energized circuits. Access holes for test probes are provided over each terminal. Nylon clips are included with each cover. Covers meet UL94V-0, with 50°C temperature index. Blank circuit identification optional.

For SSB3, RSB3, RSB6 and SSB7 Series.

**Related Product Data**

**Wire Pins and Ferrules**

Pages 109-111  
For more information on Tyco Electronics Standard Terminals and Splices or Quick-Connect FASTON Receptacles and Tabs, request Catalog 82042.

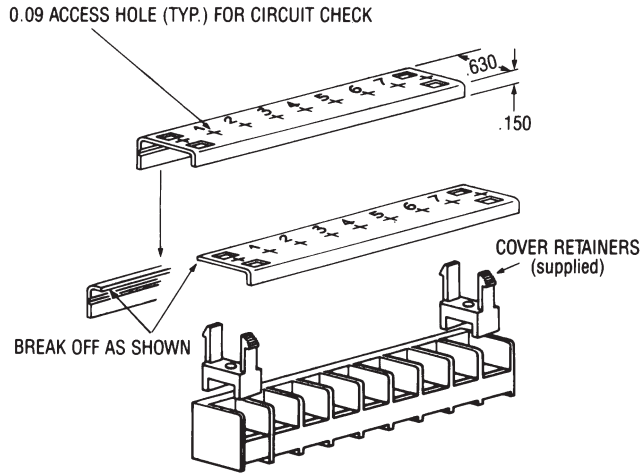

**Ordering Information**



Barrier Strips  
**2**



**Note:** All part numbers are RoHS Compliant.

**Accessories — Quick-Connect (QC) Tabs**

**Physical Properties**

**Tabs**

**Material**—Tin plated brass

**Dimensions**— #4 Series 0.187" wide x 0.020" thick, #6 Series 0.250" wide x 0.032" thick (0.187" x 0.020" optional), #8 Series 0.250" wide x 0.032" thick

**Ordering Information: Tabs**

**QC4 - 180 - 3**

**A**

**B**

**C**

**A Style Size**

**QC4** = for #4 Series (45° tab angle not available)

**QC6** = for #6 Series

**QC8** = for #8 Series

**C Tab Size**

**3** = 0.187 w x 0.020

**4** = 0.250 w x 0.032

**B Tab Angle**

**180** = 180° (flat)

**45** = 45°

**90** = 90°

**Note:** QC tabs may be stacked to achieve several angle configurations.



90°

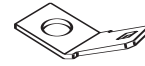

45°

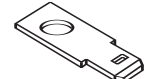

180°

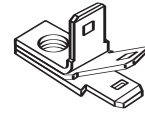

Stackable Tabs

**.375" Pitch, Double Row**

**QUICK-CONNECT Tabs**

Description	.250 wide x .032 thick		.187 wide x .032 thick	
	Part No.	Cat. No.	Part No.	Cat. No.
Flat, Two-Sided	—	1776860-1	—	1776803-1
45°, Two-Sided	∨	1776860-2	—	1776803-2
90°, Two-Sided	⊥	1776860-3	—	1776803-3
Flat, Single-Sided	—	1776843-1	—	—
45°, Single-Sided	∨	1776843-2	—	—
90°, Single-Sided	⊥	1776843-3	—	—

**.563" Pitch, Double Row**

**QUICK-CONNECT Tabs**

Description	.250 wide x .032 thick	
	Part No.	Cat. No.
Flat, Two-Sided	—	1776173-1
45°, Two-Sided	∨	1776173-2
90°, Two-Sided	⊥	1776173-3
45°/90°, Two-Sided	∨	1776173-4
Flat, Single-Sided	—	1776174-1
45°, Single-Sided	∨	1776174-2
90°, Single-Sided	⊥	1776174-3

**.0325" Pitch, Series SSB3**

**QUICK-CONNECT Tabs**

Description	.110 wide x .020 thick		.187 wide x .020 thick	
	Part No.	Cat. No.	Part No.	Cat. No.
Flat, Two-Sided	—	5-1437402-7 QC10	7-1437402-5	QC70
45°, Two-Sided	∨	5-1437402-8 QC11	7-1437402-6	QC71
90°, Two-Sided	⊥	5-1437402-9 QC12	7-1437402-7	QC72
Flat, Single-Sided	—	6-1437402-0 QC13	7-1437402-8	QC73
45°, Single-Sided	∨	6-1437402-1 QC14	7-1437402-9	QC74
90°, Single-Sided	⊥	6-1437402-2 QC15-BU	8-1437402-0	QC75

**.437" Pitch, Double Row**

**QUICK-CONNECT Tabs**

Description	.250 wide x .032 thick	
	Part No.	Cat. No.
Flat, Two-Sided	—	1776057-3
45°, Two-Sided	∨	1776057-2
90°, Two-Sided	⊥	1776057-1
Flat, Single-Sided	—	1776110-3
45°, Single-Sided	∨	1776110-2
90°, Single-Sided	⊥	1776110-1

**.375" & .4375" Pitch, Series JC6 and SSB7**

**QUICK-CONNECT Tabs**

Description	.250 wide x .032 thick		.187 wide x .020 thick	
	Part No.	Cat. No.	Part No.	Cat. No.
Flat, Two-Sided	—	1546986-1 QC20-BU	6-1437402-9	QC40-BU
45°, Two-Sided	∨	1546986-3 QC21	7-1437402-0	QC41
90°, Two-Sided	⊥	1546986-4 QC22	7-1437402-1	QC42
Flat, Single-Sided	—	6-1437402-5 QC23	7-1437402-2	QC43
45°, Single-Sided	∨	6-1437402-6 QC24	7-1437402-3	QC44
90°, Single-Sided	⊥	6-1437402-7 QC25	7-1437402-4	QC45
Flat, Two-Sided, Extra-Long	1776090-1	—	—	—
90°, Two-Sided, Extra-Long	1776090-2	—	—	—
45°, Two-Sided, Extra-Long	1776090-3	—	—	—

**Related Product Data**

**Wire Pins and Ferrules**

Pages 109-111

For more information on Tyco Electronics Standard Terminals and Splices or Quick-Connect FASTON Receptacles and Tabs, request Catalog 82042.

**Solder Tabs:**

For making top-side solder connections  
Single-Sided

Part No.	Cat. No.
1-1437403-1	ST80

**Order Number**

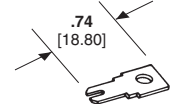

ST80

**Note:** All part numbers are RoHS Compliant.

**Accessories — Jumpers**

**AROUND-THE-BARRIER**  
40 circuits; snap apart to desired lengths.  
**Spade Jumper**

**Catalog Number Part No.**  
**J3140** (for 0.325" Pitch) 5-1437418-3



**Spade Jumper**

**J6140** (for 0.375" Pitch and #6 Screw) 5-1437418-4



**Flanged Spade Jumper**

**J6240** (for 0.375" Pitch and #6 Screw) 5-1437418-5



**Spade Jumper**

**Catalog Number Part No.**  
**J7140** (for 0.4375" Pitch and #6 Screw) 5-1437418-7

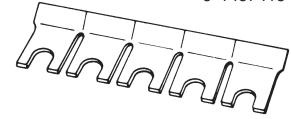

**Flanged Spade Jumper**

**J7240** (for 0.4375" Pitch and #6 Screw) 5-1437418-8

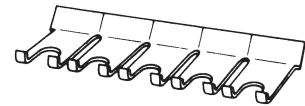

**Ring Tongue Jumper**

**J6340** (for 0.375" Pitch and #6 Screw) 5-1437418-6

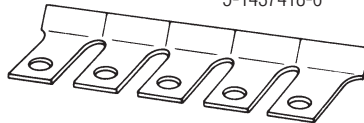

**Ring Tongue Jumper**

**J7340** (for 0.4375" Pitch and #6 Screw) 5-1437418-9



**Over-the-Barrier Two Circuit (Brass, Tin Plated)**

**Spade Jumper**

**J74** (for 0.375" Pitch, Series RSB6 & SSB6; 0.4375" Pitch, SSB7) 6-1437418-0



**J76** (0.4375" and 0.375" Double-Row) 1776058-1

**Ring Tongue Jumper**

**J75** (for 0.375" Pitch, Series RSB6 & SSB6; 0.4375" Pitch, SSB7) 6-1437418-1



**J77** (0.563" Double-Row) 1776058-1

**Order Number**

**JX X**

**A B**

**A Block Series**

- J3** = #3 Series
- J4** = #4 Series, 4DB
- J6** = #6 Series, JC6, BC6, NC6, MB6
- J8** = #8 Series, 1546670, 1546671

**B No. of Circuits (Not positions)**  
2 through 16



Jumpers J4, J6 and J8







Jumpers J3

Block Series	Centerline Spacing A
J3	6,4 (0.250")
J4	8,3 (0.325")
J6	9,5 (0.375")
J8	11,1 (0.438")

**Note:** All part numbers are RoHS Compliant.

**Accessories — Hardware & Brackets**

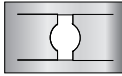
		<b>Catalog Number</b>	<b>Part Number</b>	<b>Description</b>	<b>Series</b>
<b>Binding Head Screws</b>		<b>3L01</b>	1437402-2	#6-32 Steel w/clear chromate	RSB3, SSB3
		<b>L01</b>	2-1437402-4	#6-32 Steel w/clear chromate	SSB6, SSB7, RSB6
		—	8-1437649-4	#4-40 Steel w/clear chromate	Series #4
			1437651-8	#6-32 Steel w/clear chromate	Series #6, BC6, NC6, JC6
		<b>L03</b>	2-1437402-6	#6-32 Stainless Steel	SSB6, SSB7, RSB6 Series #6, JC6
		<b>L04</b>	2-1437402-7	#6-32 Brass w/nickel plate	SSB6, SSB7, RSB6
		—	1447429-1	#8-32 Steel w/clear chromate	Series #8
<b>Wire Clamp Screws</b>		<b>3L02</b>	1437402-3	#6-32 Steel w/clear chromate	RSB3, SSB3
		<b>L02</b>	2-1437402-5	#6-32 Steel w/clear chromate	SSB6, SSB7, RSB6
		<b>L09</b>	2-1437402-8	#6-32 Brass w/nickel plate	SSB6, SSB7, RSB6
		—	8-1437649-0	#4-40 Steel w/clear chromate	Series #4
		—	1437651-5	#6-32 Brass w/nickel plate	Series #6, BC6, JC6, NC6, MB6
		—	1437651-2	#6-32 Steel w/clear chromate	Series #6, BC6, JC6, NC6, MB6
		—	1447425-1	#8-32 Steel w/clear chromate	Series #8
		—	9-1437667-9	#6-32 Steel w/clear chromate	4DB

		<b>Catalog Number</b>	<b>Part No.</b>
<b>MOUNTING INSERTS</b> (Nylon) for mounting RSBs with blank end sections		<b>L91</b>	5-1437402-1
<b>PRESS-ON RETAINING CLIPS</b> (Stainless Steel) for mounting turret base SSBs, JC6, and BC6		<b>JC/BC-Retaining</b>	1437661-7
<b>Angle Bracket</b> for mounting SSBs with right angle terminals, copper alloy, tin plated		<b>L92</b>	5-1437402-2

**Note:** All part numbers are RoHS Compliant.

**Accessories — Standard and Custom Legends**

**Product Facts**

- n Permanent markings, impervious to cleaning solvents per MIL-STD 202, Method 215
- n Alphabetical and numerical legending
- n Numbers and characters can be in any order
- n Size and spacing of characters may be tailored to your application
- n White markings standard
- n Custom legends available on special request



Custom legending can lend a personal touch to your product...helps in circuit identification and makes wiring faster and easier. Alphabetical and numerical markings are available in either standard or custom styles to best suit your specific applications. Legending is available to the styles depicted below.

**Standard Legending Arrangements**

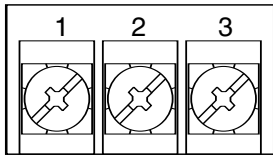

Style A1

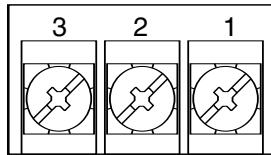

Style B1

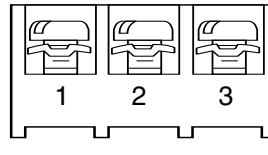

Style C1

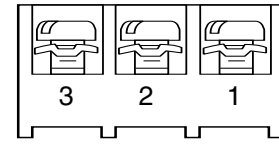

Style D1

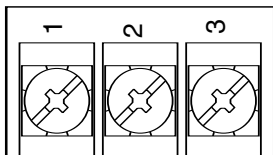

Style A2

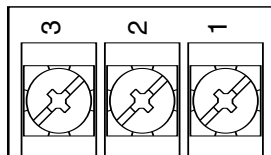

Style B2

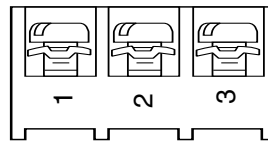

Style C2

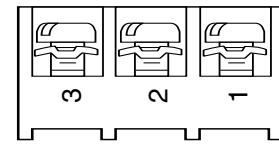

Style D2

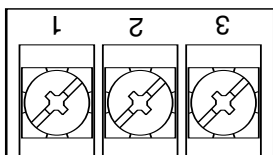

Style A3

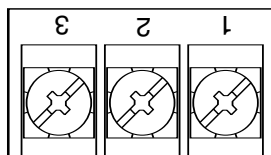

Style B3

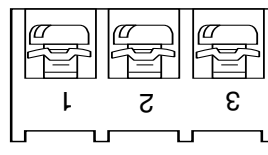

Style C3

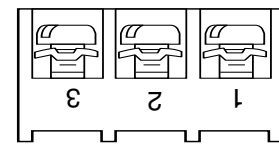

Style D3

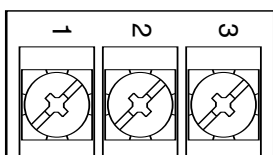

Style A4

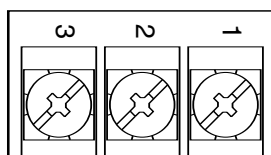

Style B4

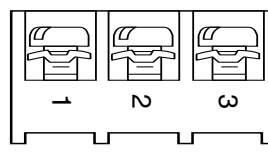

Style C4

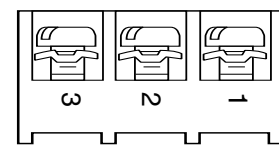

Style D4

**Note:** All part numbers  
are RoHS Compliant.

---

## Engineering Notes

---



Компания «Океан Электроники» предлагает заключение долгосрочных отношений при поставках импортных электронных компонентов на взаимовыгодных условиях!

Наши преимущества:

- Поставка оригинальных импортных электронных компонентов напрямую с производств Америки, Европы и Азии, а так же с крупнейших складов мира;
- Широкая линейка поставок активных и пассивных импортных электронных компонентов (более 30 млн. наименований);
- Поставка сложных, дефицитных, либо снятых с производства позиций;
- Оперативные сроки поставки под заказ (от 5 рабочих дней);
- Экспресс доставка в любую точку России;
- Помощь Конструкторского Отдела и консультации квалифицированных инженеров;
- Техническая поддержка проекта, помощь в подборе аналогов, поставка прототипов;
- Поставка электронных компонентов под контролем ВП;
- Система менеджмента качества сертифицирована по Международному стандарту ISO 9001;
- При необходимости вся продукция военного и аэрокосмического назначения проходит испытания и сертификацию в лаборатории (по согласованию с заказчиком);
- Поставка специализированных компонентов военного и аэрокосмического уровня качества (Xilinx, Altera, Analog Devices, Intersil, Interpoint, Microsemi, Actel, Aeroflex, Peregrine, VPT, Syfer, Eurofarad, Texas Instruments, MS Kennedy, Miteq, Cobham, E2V, MA-COM, Hittite, Mini-Circuits, General Dynamics и др.);

Компания «Океан Электроники» является официальным дистрибьютором и эксклюзивным представителем в России одного из крупнейших производителей разъемов военного и аэрокосмического назначения «JONHON», а так же официальным дистрибьютором и эксклюзивным представителем в России производителя высокотехнологичных и надежных решений для передачи СВЧ сигналов «FORSTAR».



## JONHON

«JONHON» (основан в 1970 г.)

Разъемы специального, военного и аэрокосмического назначения:

(Применяются в военной, авиационной, аэрокосмической, морской, железнодорожной, горно- и нефтедобывающей отраслях промышленности)

«FORSTAR» (основан в 1998 г.)

ВЧ соединители, коаксиальные кабели, кабельные сборки и микроволновые компоненты:

(Применяются в телекоммуникациях гражданского и специального назначения, в средствах связи, РЛС, а так же военной, авиационной и аэрокосмической отраслях промышленности).



Телефон: 8 (812) 309-75-97 (многоканальный)

Факс: 8 (812) 320-03-32

Электронная почта: [ocean@oceanchips.ru](mailto:ocean@oceanchips.ru)

Web: <http://oceanchips.ru/>

Адрес: 198099, г. Санкт-Петербург, ул. Калинина, д. 2, корп. 4, лит. А