

# LDA10F

LDA 10 F -5 -□

① ② ③ ④ ⑤



Recommended EMI/EMC Filter  
NAC-06-472



High voltage pulse noise type : NAP series  
Low leakage current type : NAM series  
\*The EMI/EMC Filter is recommended to connect with several devices.

- ① Series name
- ② Output wattage
- ③ Universal input
- ④ Output voltage
- ⑤ Optional \*2
- C : with Coating
- G : Low leakage current
- S : with Chassis
- SN : with Chassis & cover
- Y : with Potentiometer

| MODEL                 | LDA10F-3 | LDA10F-5 | LDA10F-12 | LDA10F-15 | LDA10F-24 |
|-----------------------|----------|----------|-----------|-----------|-----------|
| MAX OUTPUT WATTAGE[W] | 6        | 10       | 10.8      | 10.5      | 12        |
| DC OUTPUT             | 3V 2.0A  | 5V 2.0A  | 12V 0.9A  | 15V 0.7A  | 24V 0.5A  |

## SPECIFICATIONS

|                               | MODEL  | LDA10F-3  | LDA10F-5   | LDA10F-12   | LDA10F-15   | LDA10F-24 |        |
|-------------------------------|--|---|--|-------------|-------------|-----------|--------|
| INPUT                         | VOLTAGE[V]   | AC85 - 264 1 φ or DC110 - 370   |  |             |             |           |        |
|                               | CURRENT[A]   | ACIN 100V   | 0.25typ (I <sub>o</sub> =100%)   |             |             |           |        |
|                               |  | ACIN 200V   | 0.16typ (I <sub>o</sub> =100%)   |             |             |           |        |
|                               | FREQUENCY[Hz]  | 47 - 440 or DC  |  |             |             |           |        |
|                               | EFFICIENCY[%]  | 68typ   | 72typ  | 74typ       | 74typ       | 78typ     |        |
|                               | INRUSH CURRENT[A]                                    | ACIN 100V   | 15typ (I <sub>o</sub> =100%) (At cold start)   |             |             |           |        |
|                               |  | ACIN 200V   | 30typ (I <sub>o</sub> =100%) (At cold start)   |             |             |           |        |
| LEAKAGE CURRENT[mA]           | 0.75max (60Hz, According to UL, CSA, VDE and DEN-AN) |   |  |             |             |           |        |
| OUTPUT                        | VOLTAGE[V]   | 3   | 5  | 12          | 15          | 24        |        |
|                               | CURRENT[A]   | 2   | 2  | 0.9         | 0.7         | 0.5       |        |
|                               | LINE REGULATION[mV]                                  | 20max   | 20max  | 48max       | 60max       | 96max     |        |
|                               | LOAD REGULATION[mV]                                  | 40max   | 40max  | 100max      | 120max      | 150max    |        |
|                               | RIPPLE[mVp-p]  | 0 to +50°C  | 80max  | 80max       | 120max      | 120max    | 120max |
|                               |  | -10 - 0°C   | 140max   | 140max      | 160max      | 160max    | 160max |
|                               | RIPPLE NOISE[mVp-p]                                  | 0 to +50°C  | 120max   | 120max      | 150max      | 150max    | 150max |
|                               |  | -10 - 0°C   | 160max   | 160max      | 180max      | 180max    | 180max |
|                               | TEMPERATURE REGULATION[mV]                           | 50max   | 50max  | 120max      | 150max      | 240max    |        |
|                               | DRIFT[mV]  | *1 20max  | 20max  | 48max       | 60max       | 96max     |        |
|                               | START-UP TIME[ms]                                    | 200max (ACIN 100V, I <sub>o</sub> =100%)  |  |             |             |           |        |
|                               | HOLD-UP TIME[ms]                                     | 10typ (ACIN 85V, I <sub>o</sub> =100%) 20typ (ACIN 100V, I <sub>o</sub> =100%) 100typ (ACIN 200V, I <sub>o</sub> =100%) |  |             |             |           |        |
|                               | OUTPUT VOLTAGE ADJUSTMENT RANGE[V]                   | 2.85 - 3.6  | Fixed ("Y" which can be adjusted the output is available as option :5, 12, 15, 24V ±10%) |             |             |           |        |
| OUTPUT VOLTAGE SETTING[V]     | —  | 4.9 - 5.3   | 11.5 - 12.5  | 14.4 - 15.6 | 23.0 - 25.0 |           |        |
| PROTECTION CIRCUIT AND OTHERS | OVERCURRENT PROTECTION                               | Works over 105% of rating and recovers automatically  |  |             |             |           |        |
|                               | OVERVOLTAGE PROTECTION                               | 4.00V min   | Works over 115% of rating, by zener diode clamping                                       |             |             |           |        |
|                               | OPERATING INDICATION                                 | Not provided  |  |             |             |           |        |
|                               | REMOTE SENSING                                       | Not provided  |  |             |             |           |        |
| ISOLATION                     | REMOTE ON/OFF  | Not provided  |  |             |             |           |        |
|                               | INPUT-OUTPUT   | AC3.000V 1minute, Cutoff current = 10mA, DC500V 50MΩ min (At Room Temperature)  |  |             |             |           |        |
|                               | INPUT-FG   | AC2.000V 1minute, Cutoff current = 10mA, DC500V 50MΩ min (At Room Temperature)  |  |             |             |           |        |
| ENVIRONMENT                   | OUTPUT-FG  | AC500V 1minute, Cutoff current = 100mA, DC500V 50MΩ min (At Room Temperature)   |  |             |             |           |        |
|                               | OPERATING TEMP., HUMID. AND ALTITUDE                 | -10 to +60°C, 20 - 90%RH (Non condensing) (Refer to DERATING CURVE) 3.000m (10.000feet) max                             |  |             |             |           |        |
|                               | STORAGE TEMP., HUMID. AND ALTITUDE                   | -20 to +75°C, 20 - 90%RH (Non condensing) 9.000m (30.000feet) max   |  |             |             |           |        |
|                               | VIBRATION  | 10 - 55Hz, 19.6m/s <sup>2</sup> (2G), 3minutes period, 60minutes each along X, Y and Z axis                             |  |             |             |           |        |
| SAFETY AND NOISE REGULATIONS  | IMPACT   | 196.1m/s <sup>2</sup> (20G), 11ms, once each X, Y and Z axis  |  |             |             |           |        |
|                               | AGENCY APPROVALS                                     | UL60950-1, EN60950-1, EN50178, CSA C22.2 No.60950-1 Complies with DEN-AN and IEC60950-1                                 |  |             |             |           |        |
|                               | CONDUCTED NOISE                                      | Complies with FCC-B, CISPR22-B, EN55022-B, VCCI-B   |  |             |             |           |        |
| OTHERS                        | CASE SIZE/WEIGHT                                     | 50 X 21 X 105mm (W X H X D) /75g max (without chassis and cover)  |  |             |             |           |        |
|                               | COOLING METHOD                                       | Convection  |  |             |             |           |        |

\*1 Drift is the change in DC output for an eight hour period after a half-hour warm-up at 25°C, with the input voltage held constant at the rated input/output.  
 \*2 Please contact us about safety approvals for the model with option.  
 \* Avoid prolonged use under over-load.  
 \* Series/Parallel operation with other model is not possible.  
 \* Derating is required when operated with chassis and cover.

## External view



| I/O Connector | Mating Connector | Terminal            |
|---------------|------------------|---------------------|
| CN1           | B3P5-VH          | VHR-5N              |
|               |                  | Chain:SVH-21T-P1.1  |
|               |                  | Loose:BVH-21T-P1.1  |
| CN2           | B4B-XH-A         | XHP-4               |
|               |                  | Chain:SXH-001T-P0.6 |
|               |                  | Loose:BXH-001T-P0.6 |

(Mir : J.S.T.)

### <PIN CONNECTION>

| Pin No. | Input |
|---------|-------|
| 1       | AC(L) |
| 2       |       |
| 3       | AC(N) |
| 4       |       |
| 5       | FG    |

| Pin No. | Output |
|---------|--------|
| 1       | -V     |
| 2       | -V     |
| 3       | +V     |
| 4       | +V     |

※ Keep drawing current per pin below 2A for CN2.

- ※ Weight : 75g or less (Without chassis and cover)
- ※ Tolerance : ±1
- ※ Dimensions in mm.
- ※ PCB Material : Glass composite (CEM3)
- ※ Chassis and cover is optional.
- ※ Mounting torque : 0.6N·m (6.3kgf·cm) max

LDA

## Performance data

### ■ STATIC CHARACTERISTICS (LDA10F-5)



### ■ RISE TIME & FALL TIME (LDA10F-5)

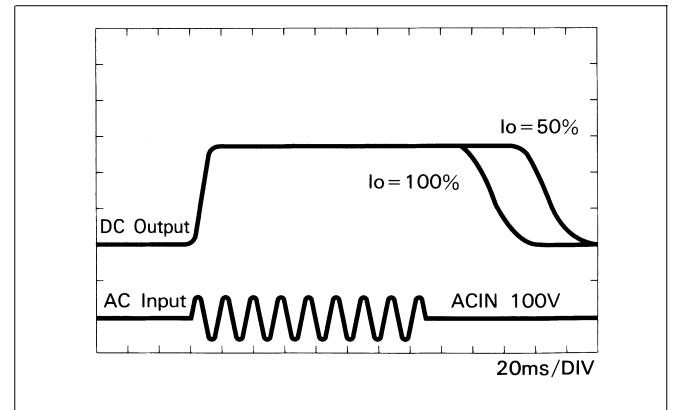

### ■ OVERCURRENT CHARACTERISTICS (LDA10F-5)



### ■ DERATING CURVE

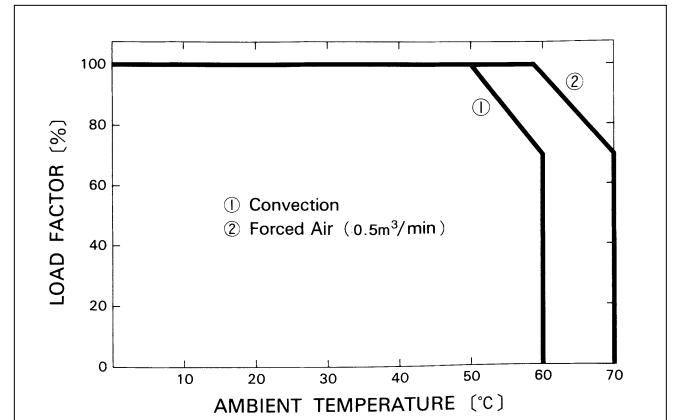

# LDA15F

LDA 15 F -5 -□

① ② ③ ④ ⑤



Recommended EMI/EMC Filter  
NAC-06-472



High voltage pulse noise type : NAP series  
Low leakage current type : NAM series  
\*The EMI/EMC Filter is recommended to connect with several devices.

- ① Series name
- ② Output wattage
- ③ Universal input
- ④ Output voltage
- ⑤ Optional \*2
- C :with Coating
- G :Low leakage current
- S :with Chassis
- SN :with Chassis & cover
- Y :with Potentiometer

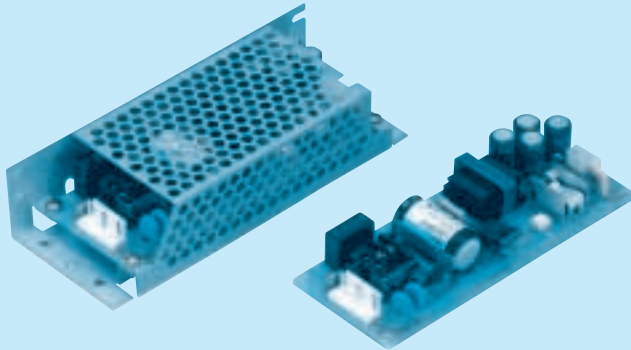

| MODEL                 | LDA15F-3 | LDA15F-5 | LDA15F-12 | LDA15F-15 | LDA15F-24 |
|-----------------------|----------|----------|-----------|-----------|-----------|
| MAX OUTPUT WATTAGE[W] | 9        | 15       | 15.6      | 15        | 16.8      |
| DC OUTPUT             | 3V 3.0A  | 5V 3.0A  | 12V 1.3A  | 15V 1.0A  | 24V 0.7A  |

## SPECIFICATIONS

|                               | MODEL  | LDA15F-3  | LDA15F-5  | LDA15F-12   | LDA15F-15   | LDA15F-24 |        |
|-------------------------------|--|---|---|-------------|-------------|-----------|--------|
| INPUT                         | VOLTAGE[V]   | AC85 - 264 1 φ or DC110 - 370   |   |             |             |           |        |
|                               | CURRENT[A]   | ACIN 100V   | 0.37typ (Io=100%)   |             |             |           |        |
|                               |  | ACIN 200V   | 0.23typ (Io=100%)   |             |             |           |        |
|                               | FREQUENCY[Hz]  | 47 - 440 or DC  |   |             |             |           |        |
|                               | EFFICIENCY[%]  | 70typ   | 74typ   | 76typ       | 76typ       | 78typ     |        |
|                               | INRUSH CURRENT[A]                                    | ACIN 100V   | 15typ (Io=100%) (At cold start)   |             |             |           |        |
|                               |  | ACIN 200V   | 30typ (Io=100%) (At cold start)   |             |             |           |        |
| LEAKAGE CURRENT[mA]           | 0.75max (60Hz, According to UL, CSA, VDE and DEN-AN) |   |   |             |             |           |        |
| OUTPUT                        | VOLTAGE[V]   | 3   | 5   | 12          | 15          | 24        |        |
|                               | CURRENT[A]   | 3   | 3   | 1.3         | 1           | 0.7       |        |
|                               | LINE REGULATION[mV]                                  | 20max   | 20max   | 48max       | 60max       | 96max     |        |
|                               | LOAD REGULATION[mV]                                  | 40max   | 40max   | 100max      | 120max      | 150max    |        |
|                               | RIPPLE[mVp-p]  | 0 to +50°C  | 80max   | 80max       | 120max      | 120max    | 120max |
|                               |  | -10 - 0°C   | 140max  | 140max      | 160max      | 160max    | 160max |
|                               | RIPPLE NOISE[mVp-p]                                  | 0 to +50°C  | 120max  | 120max      | 150max      | 150max    | 150max |
|                               |  | -10 - 0°C   | 160max  | 160max      | 180max      | 180max    | 180max |
|                               | TEMPERATURE REGULATION[mV]                           | 50max   | 50max   | 120max      | 150max      | 240max    |        |
|                               | DRIFT[mV]  | *1 20max  | 20max   | 48max       | 60max       | 96max     |        |
|                               | START-UP TIME[ms]                                    | 200max (ACIN 100V, Io=100%)   |   |             |             |           |        |
|                               | HOLD-UP TIME[ms]                                     | 10typ (ACIN 85V, Io=100%) 20typ (ACIN 100V, Io=100%) 100typ (ACIN 200V, Io=100%)            |   |             |             |           |        |
|                               | OUTPUT VOLTAGE ADJUSTMENT RANGE[V]                   | 2.85 - 3.6  | Fixed ("Y"which can be adjusted the output is available as option :5, 12, 15, 24V ±10%) |             |             |           |        |
| OUTPUT VOLTAGE SETTING[V]     | —  | 4.9 - 5.3   | 11.5 - 12.5   | 14.4 - 15.6 | 23.0 - 25.0 |           |        |
| PROTECTION CIRCUIT AND OTHERS | OVERCURRENT PROTECTION                               | Works over 105% of rating and recovers automatically  |   |             |             |           |        |
|                               | OVERVOLTAGE PROTECTION                               | 4.00V min   | Works over 115% of rating, by zener diode clamping                                      |             |             |           |        |
|                               | OPERATING INDICATION                                 | Not provided  |   |             |             |           |        |
|                               | REMOTE SENSING                                       | Not provided  |   |             |             |           |        |
| ISOLATION                     | REMOTE ON/OFF  | Not provided  |   |             |             |           |        |
|                               | INPUT-OUTPUT   | AC3.000V 1minute, Cutoff current = 10mA, DC500V 50MΩ min (At Room Temperature)              |   |             |             |           |        |
|                               | INPUT-FG   | AC2.000V 1minute, Cutoff current = 10mA, DC500V 50MΩ min (At Room Temperature)              |   |             |             |           |        |
| ENVIRONMENT                   | OUTPUT-FG  | AC500V 1minute, Cutoff current = 100mA, DC500V 50MΩ min (At Room Temperature)               |   |             |             |           |        |
|                               | OPERATING TEMP.,HUMID.AND ALTIITUDE                  | -10 to +60°C, 20 - 90%RH (Non condensing) (Refer to DERATING CURVE) 3.000m (10.000feet) max |   |             |             |           |        |
|                               | STORAGE TEMP.,HUMID.AND ALTIITUDE                    | -20 to +75°C, 20 - 90%RH (Non condensing) 9.000m (30.000feet) max                           |   |             |             |           |        |
|                               | VIBRATION  | 10 - 55Hz, 19.6m/s <sup>2</sup> (2G), 3minutes period, 60minutes each along X, Y and Z axis |   |             |             |           |        |
| SAFETY AND NOISE REGULATIONS  | IMPACT   | 196.1m/s <sup>2</sup> (20G), 11ms, once each X, Y and Z axis                                |   |             |             |           |        |
|                               | AGENCY APPROVALS                                     | UL60950-1, EN60950-1, EN50178, CSA C22.2 No.60950-1 Complies with DEN-AN and IEC60950-1     |   |             |             |           |        |
|                               | CONDUCTED NOISE                                      | Complies with FCC-B, CISPR22-B, EN55022-B, VCCI-B   |   |             |             |           |        |
| OTHERS                        | CASE SIZE/WEIGHT                                     | 50 X 21 X 125mm (W X H X D) /95g max (without chassis and cover)                            |   |             |             |           |        |
|                               | COOLING METHOD                                       | Convection  |   |             |             |           |        |

\*1 Drift is the change in DC output for an eight hour period after a half-hour warm-up at 25°C, with the input voltage held constant at the rated input/output.  
 \*2 Please contact us about safety approvals for the model with option.  
 \* Avoid prolonged use under over-load.  
 \* Series/Parallel operation with other model is not possible.  
 \* Derating is required when operated with chassis and cover.

## External view



| I/O Connector | Mating Connector | Terminal |                      |
|---------------|------------------|----------|----------------------|
| CN1           | B3P5-VH          | VHR-5N   | Chain:SVH-21T-P1.1   |
|               |                  |          | Loose:BVH-21T-P1.1   |
| CN2           | B4B-XH-A         | XHP-4    | Chain: SXH-001T-P0.6 |
|               |                  |          | Loose: BXH-001T-P0.6 |

(Mfr : J.S.T.)

### <PIN CONNECTION>

| Pin No. | Input |
|---------|-------|
| 1       | AC(L) |
| 2       | AC(L) |
| 3       | AC(N) |
| 4       | AC(N) |
| 5       | FG    |

| Pin No. | Output |
|---------|--------|
| 1       | -V     |
| 2       | -V     |
| 3       | +V     |
| 4       | +V     |

- ※ Weight : 95g or less (Without chassis and cover)
- ※ Tolerance : ± 1
- ※ Dimensions in mm.
- ※ PCB Material : Glass composite (CEM3)
- ※ Chassis and cover is optional.
- ※ Mounting torque : 0.6N·m (6.3kgf·cm) max

## Performance data

### ■ STATIC CHARACTERISTICS (LDA15F-5)



### ■ RISE TIME & FALL TIME (LDA15F-5)

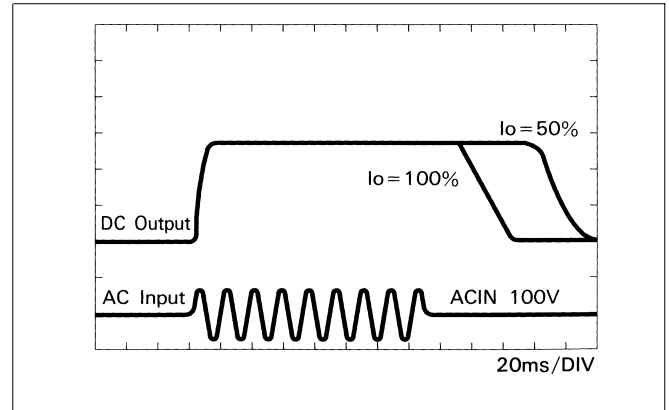

### ■ OVERCURRENT CHARACTERISTICS (LDA15F-5)

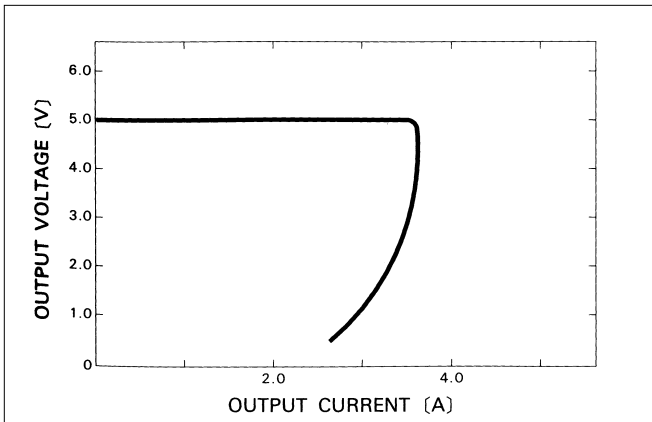

### ■ DERATING CURVE

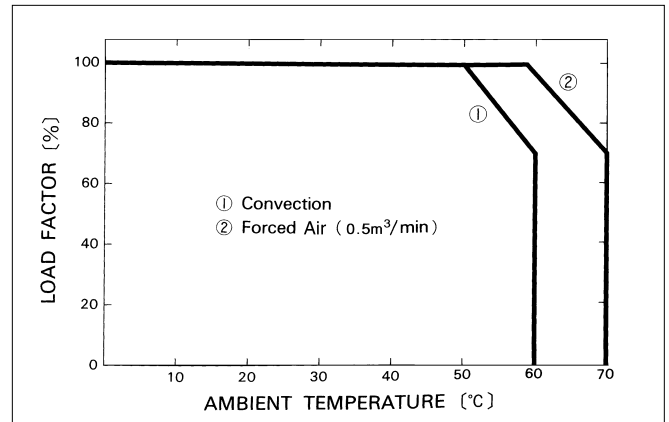

# LDA30F

LDA 30 F -5 -□

① ② ③ ④ ⑤

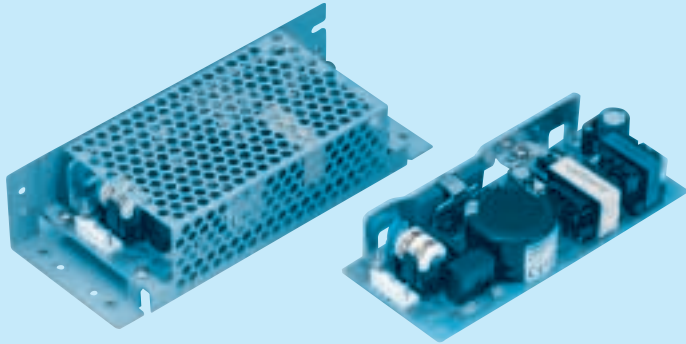

Recommended EMI/EMC Filter  
NAC-06-472



High voltage pulse noise type : NAP series  
Low leakage current type : NAM series  
\*The EMI/EMC Filter is recommended to connect with several devices.

- ① Series name
- ② Output wattage
- ③ Universal input
- ④ Output voltage
- ⑤ Optional \*2
- C :with Coating
- G :Low leakage current
- S :with Chassis
- SN :with Chassis & cover
- Y :with Potentiometer

| MODEL                 | LDA30F-3 | LDA30F-5 | LDA30F-12 | LDA30F-15 | LDA30F-24 |
|-----------------------|----------|----------|-----------|-----------|-----------|
| MAX OUTPUT WATTAGE[W] | 18       | 30       | 30        | 30        | 31.2      |
| DC OUTPUT             | 3V 6.0A  | 5V 6.0A  | 12V 2.5A  | 15V 2.0A  | 24V 1.3A  |

## SPECIFICATIONS

|                                    | MODEL  | LDA30F-3  | LDA30F-5                        | LDA30F-12   | LDA30F-15   | LDA30F-24 |        |
|------------------------------------|--|---|---------------------------------|-------------|-------------|-----------|--------|
| INPUT                              | VOLTAGE[V]   | AC85 - 264 1 φ or DC110 - 370   |                                 |             |             |           |        |
|                                    | CURRENT[A]   | ACIN 100V   | 0.8typ (Io=100%)                |             |             |           |        |
|                                    |  | ACIN 200V   | 0.4typ (Io=100%)                |             |             |           |        |
|                                    | FREQUENCY[Hz]  | 47 - 440 or DC  |                                 |             |             |           |        |
|                                    | EFFICIENCY[%]  | 70typ   | 75typ                           | 77typ       | 78typ       | 79typ     |        |
|                                    | INRUSH CURRENT[A]                                    | ACIN 100V   | 15typ (Io=100%) (At cold start) |             |             |           |        |
|                                    |  | ACIN 200V   | 30typ (Io=100%) (At cold start) |             |             |           |        |
| LEAKAGE CURRENT[ma]                | 0.75max (60Hz, According to UL, CSA, VDE and DEN-AN) |   |                                 |             |             |           |        |
| OUTPUT                             | VOLTAGE[V]   | 3   | 5                               | 12          | 15          | 24        |        |
|                                    | CURRENT[A]   | 6   | 6                               | 2.5         | 2           | 1.3       |        |
|                                    | LINE REGULATION[mV]                                  | 20max   | 20max                           | 48max       | 60max       | 96max     |        |
|                                    | LOAD REGULATION[mV]                                  | 40max   | 40max                           | 100max      | 120max      | 150max    |        |
|                                    | RIPPLE[mVp-p]  | 0 to +50°C  | 80max                           | 80max       | 120max      | 120max    | 120max |
|                                    |  | -10 - 0°C   | 140max                          | 140max      | 160max      | 160max    | 160max |
|                                    | RIPPLE NOISE[mVp-p]                                  | 0 to +50°C  | 120max                          | 120max      | 150max      | 150max    | 150max |
|                                    |  | -10 - 0°C   | 160max                          | 160max      | 180max      | 180max    | 180max |
|                                    | TEMPERATURE REGULATION[mV]                           | 60max   | 60max                           | 150max      | 180max      | 290max    |        |
|                                    | DRIFT[mV]  | *1 20max  | 20max                           | 48max       | 60max       | 96max     |        |
|                                    | START-UP TIME[ms]                                    | 200max (ACIN 100V, Io=100%)   |                                 |             |             |           |        |
|                                    | HOLD-UP TIME[ms]                                     | 10typ (ACIN 85V, Io=100%) 20typ (ACIN 100V, Io=100%)  |                                 |             |             |           |        |
| OUTPUT VOLTAGE ADJUSTMENT RANGE[V] | 2.85 - 3.6   | Fixed ("Y"which can be adjusted the output is available as option :5, 12, 15, 24V ±10%)     |                                 |             |             |           |        |
| OUTPUT VOLTAGE SETTING[V]          | —  | 4.9 - 5.3   | 11.5 - 12.5                     | 14.4 - 15.6 | 23.0 - 25.0 |           |        |
| PROTECTION CIRCUIT AND OTHERS      | OVERCURRENT PROTECTION                               | Works over 105% of rating and recovers automatically  |                                 |             |             |           |        |
|                                    | OVERVOLTAGE PROTECTION                               | 4.00 - 5.25V  | Works at 115 - 140% of rating   |             |             |           |        |
|                                    | OPERATING INDICATION                                 | Not provided  |                                 |             |             |           |        |
|                                    | REMOTE SENSING                                       | Not provided  |                                 |             |             |           |        |
| ISOLATION                          | REMOTE ON/OFF  | Not provided  |                                 |             |             |           |        |
|                                    | INPUT-OUTPUT   | AC3.000V 1minute, Cutoff current = 10mA, DC500V 50MΩ min (At Room Temperature)              |                                 |             |             |           |        |
|                                    | INPUT-FG   | AC2.000V 1minute, Cutoff current = 10mA, DC500V 50MΩ min (At Room Temperature)              |                                 |             |             |           |        |
| ENVIRONMENT                        | OUTPUT-FG  | AC500V 1minute, Cutoff current = 100mA, DC500V 50MΩ min (At Room Temperature)               |                                 |             |             |           |        |
|                                    | OPERATING TEMP.,HUMID.AND ALTIITUDE                  | -10 to +60°C, 20 - 90%RH (Non condensing) (Refer to DERATING CURVE) 3.000m (10.000feet) max |                                 |             |             |           |        |
|                                    | STORAGE TEMP.,HUMID.AND ALTIITUDE                    | -20 to +75°C, 20 - 90%RH (Non condensing) 9.000m (30.000feet) max                           |                                 |             |             |           |        |
|                                    | VIBRATION  | 10 - 55Hz, 19.6m/s <sup>2</sup> (2G), 3minutes period, 60minutes each along X, Y and Z axis |                                 |             |             |           |        |
| SAFETY AND NOISE REGULATIONS       | IMPACT   | 196.1m/s <sup>2</sup> (20G), 11ms, once each X, Y and Z axis                                |                                 |             |             |           |        |
|                                    | AGENCY APPROVALS                                     | UL60950-1, EN60950-1, EN50178, CSA C22.2 No.60950-1 Complies with DEN-AN and IEC60950-1     |                                 |             |             |           |        |
|                                    | CONDUCTED NOISE                                      | Complies with FCC-B, CISPR22-B, EN55022-B, VCCI-B   |                                 |             |             |           |        |
| OTHERS                             | CASE SIZE/WEIGHT                                     | 55 X 26 X 133mm (W X H X D) /200g max (without chassis and cover)                           |                                 |             |             |           |        |
|                                    | COOLING METHOD                                       | Convection  |                                 |             |             |           |        |

\*1 Drift is the change in DC output for an eight hour period after a half-hour warm-up at 25°C, with the input voltage held constant at the rated input/output.  
 \*2 Please contact us about safety approvals for the model with option.  
 \* Avoid prolonged use under over-load.  
 \* Series/Parallel operation with other model is not possible.  
 \* Derating is required when operated with chassis and cover.

## External view

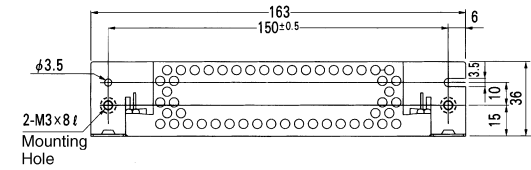

| I/O Connector | Mating Connector | Terminal                                 |
|---------------|------------------|--|
| CN1           | B3P5-VH          | VHR-5N                                   |
|               |                  | Chain:SVH-21T-P1.1<br>Loose:BVH-21T-P1.1 |
| CN2           | B4P-VH           | VHR-4N                                   |
|               |                  | Chain:SVH-21T-P1.1<br>Loose:BVH-21T-P1.1 |

(Mfr : J.S.T.)

### <PIN CONNECTION>

| Pin No. | Input |
|---------|-------|
| 1       | AC(L) |
| 2       |       |
| 3       | AC(N) |
| 4       |       |
| 5       | FG    |

| Pin No. | Output |
|---------|--------|
| 1       | -V     |
| 2       | -V     |
| 3       | +V     |
| 4       | +V     |

※ Weight : 200g or less (Without chassis and cover)

※ Tolerance : ± 1

※ Dimensions in mm.

※ PCB Material : Glass composite (CEM3)

※ Chassis and cover is optional.

※ Mounting torque : 0.6N·m (6.3kgf·cm) max

※ Keep drawing current per pin below 5A for CN2.

## Performance data

### ■ STATIC CHARACTERISTICS (LDA30F-5)



### ■ RISE TIME & FALL TIME (LDA30F-5)



### ■ OVERCURRENT CHARACTERISTICS (LDA30F-5)



### ■ DERATING CURVE





# LDA50F

LDA 50 F -5 -□

① ② ③ ④ ⑤



Recommended EMI/EMC Filter  
NAC-06-472



High voltage pulse noise type : NAP series  
Low leakage current type : NAM series  
\*The EMI/EMC Filter is recommended to connect with several devices.

- ① Series name
- ② Output wattage
- ③ Universal input
- ④ Output voltage
- ⑤ Optional \*4
- C :with Coating
- G :Low leakage current
- R :with Remote ON/OFF
- S :with Chassis
- SN :with Chassis & cover
- Y :with Potentiometer

| MODEL                 | LDA50F-3  | LDA50F-5 | LDA50F-9 | LDA50F-12 | LDA50F-15 | LDA50F-18 | LDA50F-24 | LDA50F-24-H | LDA50F-24-HR | LDA50F-30 |
|-----------------------|-----------|----------|----------|-----------|-----------|-----------|-----------|-------------|--------------|-----------|
| MAX OUTPUT WATTAGE[W] | 30        | 50       | 50.4     | 51.6      | 52.5      | 50.4      | 50.4      | 50.4        | 50.4         | 51        |
| DC OUTPUT             | *3 3V 10A | 5V 10A   | 9V 5.6A  | 12V 4.3A  | 15V 3.5A  | 18V 2.8A  | 24V 2.1A  | 24V 2.1(3)A | 24V 2.1(3)A  | 30V 1.7A  |

## SPECIFICATIONS

|                               | MODEL  | LDA50F-3  | LDA50F-5                        | LDA50F-9    | LDA50F-12   | LDA50F-15   | LDA50F-18   | LDA50F-24   | LDA50F-24-H | LDA50F-24-HR | LDA50F-30 |  |
|-------------------------------|--|---|---------------------------------|-------------|-------------|-------------|-------------|-------------|-------------|--------------|-----------|--|
| INPUT                         | VOLTAGE[V]   | AC85 - 264 1 φ or DC110 - 370   |                                 |             |             |             |             |             |             |              |           |  |
|                               | CURRENT[A]   | ACIN 100V   | 1.3typ (Io=100%)                |             |             |             |             |             |             |              |           |  |
|                               |  | ACIN 200V   | 0.7typ (Io=100%)                |             |             |             |             |             |             |              |           |  |
|                               | FREQUENCY[Hz]  | 47 - 440 or DC  |                                 |             |             |             |             |             |             |              |           |  |
|                               | EFFICIENCY[%]  | 73typ   | 77typ                           | 78typ       | 80typ       | 81typ       | 81typ       | 82typ       | 82typ       | 82typ        | 82typ     |  |
|                               | INRUSH CURRENT[A]                                    | ACIN 100V   | 15typ (Io=100%) (At cold start) |             |             |             |             |             |             |              |           |  |
|                               |  | ACIN 200V   | 30typ (Io=100%) (At cold start) |             |             |             |             |             |             |              |           |  |
| LEAKAGE CURRENT[mA]           | 0.75max (60Hz, According to UL, CSA, VDE and DEN-AN) |   |                                 |             |             |             |             |             |             |              |           |  |
| OUTPUT                        | VOLTAGE[V]   | 3   | 5                               | 9           | 12          | 15          | 18          | 24          | 24          | 24           | 30        |  |
|                               | CURRENT[A]   | *1 10   | 10                              | 5.6         | 4.3         | 3.5         | 2.8         | 2.1         | 2.1 (3)     | 2.1 (3)      | 1.7       |  |
|                               | LINE REGULATION[mV]                                  | 20max   | 20max                           | 36max       | 48max       | 60max       | 72max       | 96max       | 96max       | 96max        | 120max    |  |
|                               | LOAD REGULATION[mV]                                  | 40max   | 40max                           | 100max      | 100max      | 120max      | 120max      | 150max      | 150max      | 150max       | 180max    |  |
|                               | RIPPLE[mVp-p]  | 0 to +50°C  | 80max                           | 80max       | 120max      | 120max      | 120max      | 120max      | 120max      | 120max       | 120max    |  |
|                               |  | -10 - 0°C   | 140max                          | 140max      | 160max      | 160max      | 160max      | 160max      | 160max      | 160max       | 160max    |  |
|                               | RIPPLE NOISE[mVp-p]                                  | 0 to +50°C  | 120max                          | 120max      | 150max      | 150max      | 150max      | 150max      | 150max      | 250max       | 250max    |  |
|                               |  | -10 - 0°C   | 160max                          | 160max      | 180max      | 180max      | 180max      | 180max      | 180max      | 280max       | 280max    |  |
|                               | TEMPERATURE REGULATION[mV]                           | 60max   | 60max                           | 120max      | 150max      | 180max      | 200max      | 290max      | 290max      | 290max       | 360max    |  |
|                               | DRIFT[mV]  | *2 20max  | 20max                           | 36max       | 48max       | 60max       | 72max       | 96max       | 96max       | 96max        | 120max    |  |
|                               | START-UP TIME[ms]                                    | 200max (ACIN 100V, Io=100%)   |                                 |             |             |             |             |             |             |              |           |  |
|                               | HOLD-UP TIME[ms]                                     | 10typ (ACIN 85V, Io=100%) 20typ (ACIN 100V, Io=100%)  |                                 |             |             |             |             |             |             |              |           |  |
|                               | OUTPUT VOLTAGE ADJUSTMENT RANGE[V]                   | 2.85 - 3.6 Fixed ("Y"which can be adjusted the output is available as option :5, 9, 12, 15, 18, 24, 30V ±10%) |                                 |             |             |             |             |             |             |              |           |  |
| OUTPUT VOLTAGE SETTING[V]     | —  | 4.9 - 5.3   | 8.6 - 9.4                       | 11.5 - 12.5 | 14.4 - 15.6 | 17.3 - 18.7 | 23.0 - 25.0 | 23.0 - 25.0 | 23.0 - 25.0 | 28.5 - 31.5  |           |  |
| PROTECTION CIRCUIT AND OTHERS | OVERCURRENT PROTECTION                               | Works over 105% of rating (-H : peak) and recovers automatically  |                                 |             |             |             |             |             |             |              |           |  |
|                               | OVERVOLTAGE PROTECTION                               | 4.00 - 5.25V Works at 115 - 140% of rating  |                                 |             |             |             |             |             |             |              |           |  |
|                               | OPERATING INDICATION                                 | Not provided  |                                 |             |             |             |             |             |             |              |           |  |
|                               | REMOTE SENSING                                       | Not provided  |                                 |             |             |             |             |             |             |              |           |  |
| ISOLATION                     | REMOTE ON/OFF  | Option (Refer to Instruction Manual)  |                                 |             |             |             |             |             |             |              |           |  |
|                               | INPUT-OUTPUT   | AC3.000V 1minute, Cutoff current = 10mA, DC500V 50MΩ min (At Room Temperature)                                |                                 |             |             |             |             |             |             |              |           |  |
| ENVIRONMENT                   | INPUT-FG   | AC2.000V 1minute, Cutoff current = 10mA, DC500V 50MΩ min (At Room Temperature)                                |                                 |             |             |             |             |             |             |              |           |  |
|                               | OUTPUT-FG  | AC500V 1minute, Cutoff current = 100mA, DC500V 50MΩ min (At Room Temperature)                                 |                                 |             |             |             |             |             |             |              |           |  |
| SAFETY AND NOISE REGULATIONS  | OPERATING TEMP.,HUMID.AND ALTIITUDE                  | -10 to +60°C, 20 - 90%RH (Non condensing) (Refer to DERATING CURVE) 3.000m (10.000feet) max                   |                                 |             |             |             |             |             |             |              |           |  |
|                               | STORAGE TEMP.,HUMID.AND ALTIITUDE                    | -20 to +75°C, 20 - 90%RH (Non condensing) 9.000m (30.000feet) max   |                                 |             |             |             |             |             |             |              |           |  |
|                               | VIBRATION  | 10 - 55Hz, 19.6m/s <sup>2</sup> (2G), 3minutes period, 60minutes each along X, Y and Z axis                   |                                 |             |             |             |             |             |             |              |           |  |
| OTHERS                        | IMPACT   | 196.1m/s <sup>2</sup> (20G), 11ms, once each X, Y and Z axis  |                                 |             |             |             |             |             |             |              |           |  |
|                               | AGENCY APPROVALS                                     | UL60950-1, EN60950-1, EN50178, CSA C22.2 No.60950-1 Complies with DEN-AN and IEC60950-1                       |                                 |             |             |             |             |             |             |              |           |  |
| OTHERS                        | CONDUCTED NOISE                                      | Complies with FCC-B, CISPR22-B, EN55022-B, VCCI-B   |                                 |             |             |             |             |             |             |              |           |  |
|                               | CASE SIZE/WEIGHT                                     | 55 X 26 X 195mm (W X H X D) /250g max (without chassis and cover)   |                                 |             |             |             |             |             |             |              |           |  |
|                               | COOLING METHOD                                       | Convection  |                                 |             |             |             |             |             |             |              |           |  |

\*1 Peak load for 10sec. or less is acceptable if the total wattage is less than the rated wattage(24V:50.4W).  
 \*2 Drift is the change in DC output for an eight hour period after a half-hour warm-up at 25°C,with the input voltage held constant at the rated input/output.  
 \*3 ( ) : peak current  
 \*4 Please contact us about safety approvals for the model with option.

\* Avoid prolonged use under over-load.  
 \* Parallel operation with other model is not possible.  
 \* Derating is required when operated with chassis and cover.

## External view



| I/O Connector | Mating Connector | Terminal             |
|---------------|------------------|----------------------|
| CN1           | B3P5-VH          | VHR-5N               |
|               |                  | Chain: SVH-21T-P1.1  |
|               |                  | Loose: BVH-21T-P1.1  |
| CN2           | B4P-VH           | VHR-4N               |
|               |                  | Chain: SVH-21T-P1.1  |
|               |                  | Loose: BVH-21T-P1.1  |
| CN3           | B2B-XH-A         | XHP-2                |
|               |                  | Chain: SXH-001T-P0.6 |
|               |                  | Loose: BXH-001T-P0.6 |

### <PIN CONNECTION>

| Pin No. | Input |
|---------|-------|
| 1       | AC(L) |
| 2       |       |
| 3       | AC(N) |
| 4       |       |
| 5       | FG    |

| Pin No. | Output |
|---------|--------|
| 1       | -V     |
| 2       | -V     |
| 3       | +V     |
| 4       | +V     |

| Pin No. | Remote ON/OFF |
|---------|---------------|
| 1       | RC(+)         |
| 2       | RC(-)         |

※ Keep drawing current per pin below 5A for CN2.

- ※ Weight : 250g or less (Without chassis and cover)
- ※ Tolerance : ±1
- ※ Dimensions in mm.
- ※ PCB Material : Glass composite (CEM3)
- ※ Chassis and cover is optional.
- ※ Mounting torque : 0.6N·m (6.3kgf·cm) max

## Performance data

### ■ STATIC CHARACTERISTICS (LDA50F-5)



### ■ RISE TIME & FALL TIME (LDA50F-5)



### ■ OVERCURRENT CHARACTERISTICS (LDA50F-5)



### ■ DERATING CURVE





# LDA75F

LDA 75 F -5 -□

① ② ③ ④ ⑤



Recommended EMI/EMC Filter  
NAC-06-472



High voltage pulse noise type : NAP series  
Low leakage current type : NAM series  
\*The EMI/EMC Filter is recommended to connect with several devices.

- ① Series name
- ② Output wattage
- ③ Universal input
- ④ Output voltage
- ⑤ Optional \*4
- C :with Coating
- G :Low leakage current
- L :with LED
- R :with Remote ON/OFF
- S :with Chassis
- SN :with Chassis & cover
- Y :with Potentiometer



| MODEL                 | LDA75F-3  | LDA75F-5 | LDA75F-9 | LDA75F-12 | LDA75F-15 | LDA75F-18 | LDA75F-24 | LDA75F-24-H   | LDA75F-24-HR  | LDA75F-30 |
|-----------------------|-----------|----------|----------|-----------|-----------|-----------|-----------|---------------|---------------|-----------|
| MAX OUTPUT WATTAGE[W] | 45        | 75       | 76.5     | 75.6      | 75        | 75.6      | 76.8      | 76.8          | 76.8          | 75        |
| DC OUTPUT             | *3 3V 15A | 5V 15A   | 9V 8.5A  | 12V 6.3A  | 15V 5A    | 18V 4.2A  | 24V 3.2A  | 24V 3.2(4.5)A | 24V 3.2(4.5)A | 30V 2.5A  |

## SPECIFICATIONS

| MODEL                              | LDA75F-3                           | LDA75F-5   | LDA75F-9  | LDA75F-12 | LDA75F-15 | LDA75F-18 | LDA75F-24 | LDA75F-24-H | LDA75F-24-HR | LDA75F-30 |  |   |        |                                 |        |  |           |  |           |  |        |  |  |  |
|------------------------------------|------------------------------------|--|---|-----------|-----------|-----------|-----------|-------------|--------------|-----------|--|---|--------|---------------------------------|--------|--|-----------|--|-----------|--|--------|--|--|--|
| INPUT                              | VOLTAGE[V]                         |  |   |           |           |           |           |             |              |           |  | AC85 - 264 1 φ or DC110 - 370                               |        |                                 |        |  |           |  |           |  |        |  |  |  |
|                                    | CURRENT[A]                         |  | ACIN 100V   |           |           |           |           |             |              |           |  |   |        | 1.8typ (Io=100%)                |        |  |           |  |           |  |        |  |  |  |
|                                    |                                    |  | ACIN 200V   |           |           |           |           |             |              |           |  |   |        | 1.0typ (Io=100%)                |        |  |           |  |           |  |        |  |  |  |
|                                    | FREQUENCY[Hz]                      |  |   |           |           |           |           |             |              |           |  | 47 - 440  |        |                                 |        |  |           |  |           |  |        |  |  |  |
|                                    | EFFICIENCY[%]                      |  |   |           |           |           |           |             |              |           |  | 73typ 79typ 79typ 80typ 81typ 81typ 82typ 82typ 82typ 82typ |        |                                 |        |  |           |  |           |  |        |  |  |  |
|                                    | INRUSH CURRENT[A]                  |  | ACIN 200V   |           |           |           |           |             |              |           |  |   |        | 30typ (Io=100%) (At cold start) |        |  |           |  |           |  |        |  |  |  |
| LEAKAGE CURRENT[mA]                |                                    |  |   |           |           |           |           |             |              |           | 0.75max (60Hz, According to UL, CSA, VDE and DEN-AN) |   |        |                                 |        |  |           |  |           |  |        |  |  |  |
| OUTPUT                             | VOLTAGE[V]                         |  | 3   |           | 5         |           | 9         |             | 12           |           | 15   |   | 18     |                                 | 24     |  | 24        |  | 24        |  | 30     |  |  |  |
|                                    | CURRENT[A]                         |  | *1 15   |           | 15        |           | 8.5       |             | 6.3          |           | 5  |   | 4.2    |                                 | 3.2    |  | 3.2 (4.5) |  | 3.2 (4.5) |  | 2.5    |  |  |  |
|                                    | LINE REGULATION[mV]                |  | 20max   |           | 20max     |           | 36max     |             | 48max        |           | 60max  |   | 72max  |                                 | 96max  |  | 96max     |  | 96max     |  | 120max |  |  |  |
|                                    | LOAD REGULATION[mV]                |  | 40max   |           | 40max     |           | 100max    |             | 100max       |           | 120max   |   | 120max |                                 | 150max |  | 150max    |  | 150max    |  | 180max |  |  |  |
|                                    | RIPPLE[mVp-p]                      |  | 0 to +50°C  |           | 80max     |           | 80max     |             | 120max       |           | 120max   |   | 120max |                                 | 120max |  | 120max    |  | 120max    |  | 120max |  |  |  |
|                                    |                                    |  | -10 - 0°C   |           | 140max    |           | 140max    |             | 160max       |           | 160max   |   | 160max |                                 | 160max |  | 160max    |  | 160max    |  | 160max |  |  |  |
|                                    | RIPPLE NOISE[mVp-p]                |  | 0 to +50°C  |           | 120max    |           | 120max    |             | 150max       |           | 150max   |   | 150max |                                 | 150max |  | 150max    |  | 250max    |  | 250max |  |  |  |
|                                    |                                    |  | -10 - 0°C   |           | 160max    |           | 160max    |             | 180max       |           | 180max   |   | 180max |                                 | 180max |  | 180max    |  | 280max    |  | 280max |  |  |  |
|                                    | TEMPERATURE REGULATION[mV]         |  | 60max   |           | 60max     |           | 120max    |             | 150max       |           | 180max   |   | 200max |                                 | 290max |  | 290max    |  | 290max    |  | 360max |  |  |  |
|                                    | DRIFT[mV]                          |  | *2 20max  |           | 20max     |           | 36max     |             | 48max        |           | 60max  |   | 72max  |                                 | 96max  |  | 96max     |  | 96max     |  | 120max |  |  |  |
| START-UP TIME[ms]                  |                                    | 200max (ACIN 100V, Io=100%)  |   |           |           |           |           |             |              |           |  |   |        |                                 |        |  |           |  |           |  |        |  |  |  |
| HOLD-UP TIME[ms]                   |                                    | 10typ (ACIN 85V, Io=100%) 20typ (ACIN 100V, Io=100%)   |   |           |           |           |           |             |              |           |  |   |        |                                 |        |  |           |  |           |  |        |  |  |  |
| OUTPUT VOLTAGE ADJUSTMENT RANGE[V] |                                    | 2.85 - 3.6 Fixed ("Y"which can be adjusted the output is available as option : 5, 9, 12, 15, 18, 24, 30V ±10%) |   |           |           |           |           |             |              |           |  |   |        |                                 |        |  |           |  |           |  |        |  |  |  |
| OUTPUT VOLTAGE SETTING[V]          |                                    | — 4.9 - 5.3 8.6 - 9.4 11.5 - 12.5 14.4 - 15.6 17.3 - 18.7 23.0 - 25.0 23.0 - 25.0 23.0 - 25.0 28.5 - 31.5      |   |           |           |           |           |             |              |           |  |   |        |                                 |        |  |           |  |           |  |        |  |  |  |
| PROTECTION CIRCUIT AND OTHERS      | OVERCURRENT PROTECTION             |  | Works over 105% of rating (-H : peak) and recovers automatically                            |           |           |           |           |             |              |           |  |   |        |                                 |        |  |           |  |           |  |        |  |  |  |
|                                    | OVERVOLTAGE PROTECTION             |  | 4.00 - 5.25V Works at 115 - 140% of rating  |           |           |           |           |             |              |           |  |   |        |                                 |        |  |           |  |           |  |        |  |  |  |
|                                    | OPERATING INDICATION               |  | Not provided  |           |           |           |           |             |              |           |  |   |        |                                 |        |  |           |  |           |  |        |  |  |  |
|                                    | REMOTE SENSING                     |  | Not provided  |           |           |           |           |             |              |           |  |   |        |                                 |        |  |           |  |           |  |        |  |  |  |
| REMOTE ON/OFF                      |                                    | Option (Refer to Instruction Manual)   |   |           |           |           |           |             |              |           |  |   |        |                                 |        |  |           |  |           |  |        |  |  |  |
| ISOLATION                          | INPUT-OUTPUT                       |  | AC3,000V 1minute, Cutoff current = 10mA, DC500V 50MΩ min (At Room Temperature)              |           |           |           |           |             |              |           |  |   |        |                                 |        |  |           |  |           |  |        |  |  |  |
|                                    | INPUT-FG                           |  | AC2,000V 1minute, Cutoff current = 10mA, DC500V 50MΩ min (At Room Temperature)              |           |           |           |           |             |              |           |  |   |        |                                 |        |  |           |  |           |  |        |  |  |  |
| OUTPUT-FG                          |                                    | AC500V 1minute, Cutoff current = 100mA, DC500V 50MΩ min (At Room Temperature)                                  |   |           |           |           |           |             |              |           |  |   |        |                                 |        |  |           |  |           |  |        |  |  |  |
| ENVIRONMENT                        | OPERATING TEMP.,HUMID.AND ALTITUDE |  | -10 to +60°C, 20 - 90%RH (Non condensing) (Refer to DERATING CURVE) 3,000m (10,000feet) max |           |           |           |           |             |              |           |  |   |        |                                 |        |  |           |  |           |  |        |  |  |  |
|                                    | STORAGE TEMP.,HUMID.AND ALTITUDE   |  | -20 to +75°C, 20 - 90%RH (Non condensing) 9,000m (30,000feet) max                           |           |           |           |           |             |              |           |  |   |        |                                 |        |  |           |  |           |  |        |  |  |  |
|                                    | VIBRATION                          |  | 10 - 55Hz, 19.6m/s <sup>2</sup> (2G), 3minutes period, 60minutes each along X, Y and Z axis |           |           |           |           |             |              |           |  |   |        |                                 |        |  |           |  |           |  |        |  |  |  |
| IMPACT                             |                                    | 196.1m/s <sup>2</sup> (20G), 11ms, once each X, Y and Z axis   |   |           |           |           |           |             |              |           |  |   |        |                                 |        |  |           |  |           |  |        |  |  |  |
| SAFETY AND NOISE REGULATIONS       | AGENCY APPROVALS                   |  | UL60950-1, EN60950-1, EN50178, CSA C22.2 No.60950-1 Complies with DEN-AN and IEC60950-1     |           |           |           |           |             |              |           |  |   |        |                                 |        |  |           |  |           |  |        |  |  |  |
|                                    | CONDUCTED NOISE                    |  | Complies with FCC-B, CISPR22-B, EN55022-B, VCCI-B   |           |           |           |           |             |              |           |  |   |        |                                 |        |  |           |  |           |  |        |  |  |  |
| OTHERS                             | CASE SIZE/WEIGHT                   |  | 55 X 32 X 222mm (W X H X D) /320g max (without chassis and cover)                           |           |           |           |           |             |              |           |  |   |        |                                 |        |  |           |  |           |  |        |  |  |  |
|                                    | COOLING METHOD                     |  | Convection  |           |           |           |           |             |              |           |  |   |        |                                 |        |  |           |  |           |  |        |  |  |  |

\*1 Peak load for 10sec. or less is acceptable if the total wattage is less than the rated wattage(24V:76.8W).  
 \*2 Drift is the change in DC output for an eight hour period after a half-hour warm-up at 25°C,with the input voltage held constant at the rated input/output.  
 \*3 ( ) : peak current  
 \*4 Please contact us about safety approvals for the model with option.

\* Avoid prolonged use under over-load.  
 \* Parallel operation with other model is not possible.  
 \* Derating is required when operated with chassis and cover.

External view

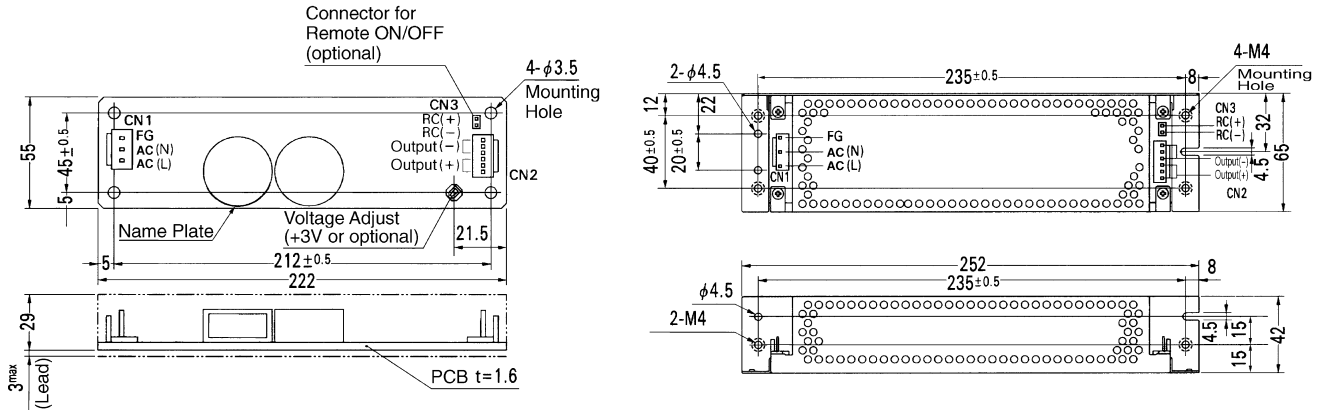

| I/O Connector | Mating Connector | Terminal  |
|---------------|------------------|---|
| CN1           | B3P5-VH          | VHR-5N<br>Chain: SVH-21T-P1.1<br>Loose: BVH-21T-P1.1  |
| CN2           | B6P-VH           | VHR-6N<br>Chain: SVH-21T-P1.1<br>Loose: BVH-21T-P1.1  |
| CN3           | B2B-XH-A         | XHP-2<br>Chain: SXH-001T-P0.6<br>Loose: BXH-001T-P0.6 |

<PIN CONNECTION>

| Pin No. | Input |
|---------|-------|
| 1       | AC(L) |
| 2       |       |
| 3       | AC(N) |
| 4       |       |
| 5       | FG    |

| Pin No. | Output |
|---------|--------|
| 1~3     | -V     |
| 4~6     | +V     |

| Pin No. | Remote ON/OFF |
|---------|---------------|
| 1       | RC(+)         |
| 2       | RC(-)         |

※Keep drawing current per pin below 5A for CN2.

- ※ Weight : 320g or less (Without chassis and cover)
- ※ Tolerance : ± 1
- ※ Dimensions in mm.
- ※ PCB Material : Glass composite (CEM3)
- ※ Chassis and cover is optional.
- ※ Mounting torque : 1.5 N·m (16 kgf·cm) max

Performance data

■ STATIC CHARACTERISTICS (LDA75F-5)



■ RISE TIME & FALL TIME (LDA75F-5)



■ OVERCURRENT CHARACTERISTICS (LDA75F-5)



■ DERATING CURVE



# LDA100W

LDA 100 W -5 -□

① ② ③ ④ ⑤



Recommended EMI/EMC Filter  
NAC-06-472



High voltage pulse noise type : NAP series  
Low leakage current type : NAM series  
\*The EMI/EMC Filter is recommended to connect with several devices.

- ① Series name
- ② Output wattage
- ③ Autoranging input
- ④ Output voltage
- ⑤ Optional \*4
- C :with Coating
- G :Low leakage current
- R :with Remote ON/OFF
- S :with Chassis
- SN :with Chassis & cover
- Y :with Potentiometer



| MODEL                 | LDA100W-3 | LDA100W-5 | LDA100W-9 | LDA100W-12 | LDA100W-15 | LDA100W-18 | LDA100W-24 | LDA100W-24-H  | LDA100W-30 | LDA100W-48 |
|-----------------------|-----------|-----------|-----------|------------|------------|------------|------------|---------------|------------|------------|
| MAX OUTPUT WATTAGE[W] | 60        | 100       | 103.5     | 102        | 100.5      | 100.8      | 103.2      | 103.2         | 105        | 96         |
| DC OUTPUT             | *3 3V 20A | 5V 20A    | 9V 11.5A  | 12V 8.5A   | 15V 6.7A   | 18V 5.6A   | 24V 4.3A   | 24V 4.3(6.5)A | 30V 3.5A   | 48V 2.0A   |

## SPECIFICATIONS

| MODEL                              | LDA100W-3                           | LDA100W-5  | LDA100W-9   | LDA100W-12 | LDA100W-15 | LDA100W-18  | LDA100W-24 | LDA100W-24-H | LDA100W-30 | LDA100W-48  |  |   |        |                                 |        |             |           |             |        |             |        |  |        |  |  |  |
|------------------------------------|-------------------------------------|--|---|------------|------------|---|------------|--------------|------------|-------------|--|---|--------|---------------------------------|--------|-------------|-----------|-------------|--------|-------------|--------|--|--------|--|--|--|
| INPUT                              | VOLTAGE[V]                          |  |   |            |            |   |            |              |            |             |  | AC 85 - 132 / 170 - 264 1 φ                                 |        |                                 |        |             |           |             |        |             |        |  |        |  |  |  |
|                                    | CURRENT[A]                          |  | ACIN 100V   |            |            |   |            |              |            |             |  |   |        | 2.4typ (Io=100%)                |        |             |           |             |        |             |        |  |        |  |  |  |
|                                    |                                     |  | ACIN 200V   |            |            |   |            |              |            |             |  |   |        | 1.2typ (Io=100%)                |        |             |           |             |        |             |        |  |        |  |  |  |
|                                    | FREQUENCY[Hz]                       |  |   |            |            |   |            |              |            |             |  | 47 - 440  |        |                                 |        |             |           |             |        |             |        |  |        |  |  |  |
|                                    | EFFICIENCY[%]                       |  |   |            |            |   |            |              |            |             |  | 75typ 79typ 80typ 81typ 82typ 82typ 83typ 83typ 83typ 82typ |        |                                 |        |             |           |             |        |             |        |  |        |  |  |  |
|                                    | INRUSH CURRENT[A]                   |  | ACIN 200V   |            |            |   |            |              |            |             |  |   |        | 30typ (Io=100%) (At cold start) |        |             |           |             |        |             |        |  |        |  |  |  |
| LEAKAGE CURRENT[mA]                |                                     |  |   |            |            |   |            |              |            |             | 0.75max (60Hz, According to UL, CSA, VDE and DEN-AN) |   |        |                                 |        |             |           |             |        |             |        |  |        |  |  |  |
| OUTPUT                             | VOLTAGE[V]                          |  | 3   |            | 5          |   | 9          |              | 12         |             | 15   |   | 18     |                                 | 24     |             | 24        |             | 30     |             | 48     |  |        |  |  |  |
|                                    | CURRENT[A]                          |  | *1 20   |            | 20         |   | 11.5       |              | 8.5        |             | 6.7  |   | 5.6    |                                 | 4.3    |             | 4.3 (6.5) |             | 3.5    |             | 2.0    |  |        |  |  |  |
|                                    | LINE REGULATION[mV]                 |  | 20max   |            | 20max      |   | 36max      |              | 48max      |             | 60max  |   | 72max  |                                 | 96max  |             | 96max     |             | 120max |             | 192max |  |        |  |  |  |
|                                    | LOAD REGULATION[mV]                 |  | 40max   |            | 40max      |   | 100max     |              | 100max     |             | 120max   |   | 120max |                                 | 150max |             | 150max    |             | 180max |             | 240max |  |        |  |  |  |
|                                    | RIPPLE[mVp-p]                       |  | 0 to +50°C  |            | 80max      |   | 80max      |              | 120max     |             | 120max   |   | 120max |                                 | 120max |             | 120max    |             | 120max |             | 150max |  |        |  |  |  |
|                                    |                                     |  | -10 - 0°C   |            | 140max     |   | 140max     |              | 160max     |             | 160max   |   | 160max |                                 | 160max |             | 160max    |             | 160max |             | 200max |  |        |  |  |  |
|                                    | RIPPLE NOISE[mVp-p]                 |  | 0 to +50°C  |            | 120max     |   | 120max     |              | 150max     |             | 150max   |   | 150max |                                 | 150max |             | 150max    |             | 250max |             | 150max |  | 400max |  |  |  |
|                                    |                                     |  | -10 - 0°C   |            | 160max     |   | 160max     |              | 180max     |             | 180max   |   | 180max |                                 | 180max |             | 180max    |             | 280max |             | 180max |  | 600max |  |  |  |
|                                    | TEMPERATURE REGULATION[mV]          |  | 60max   |            | 60max      |   | 120max     |              | 150max     |             | 180max   |   | 200max |                                 | 290max |             | 290max    |             | 360max |             | 560max |  |        |  |  |  |
|                                    | DRIFT[mV]                           |  | *2 20max  |            | 20max      |   | 36max      |              | 48max      |             | 60max  |   | 72max  |                                 | 96max  |             | 96max     |             | 120max |             | 192max |  |        |  |  |  |
| START-UP TIME[ms]                  |                                     | 200max (ACIN 100V, Io=100%)                          |   |            |            |   |            |              |            |             |  |   |        |                                 |        |             |           |             |        |             |        |  |        |  |  |  |
| HOLD-UP TIME[ms]                   |                                     | 10typ (ACIN 85V, Io=100%) 20typ (ACIN 100V, Io=100%) |   |            |            |   |            |              |            |             |  |   |        |                                 |        |             |           |             |        |             |        |  |        |  |  |  |
| OUTPUT VOLTAGE ADJUSTMENT RANGE[V] |                                     | 2.85 - 3.6   |   | 4.5 - 5.5  |            | Fixed ("Y"which can be adjusted the output is available as option :9, 12, 15, 18, 24, 30, 48V ±10%) |            |              |            |             |  |   |        |                                 |        |             |           |             |        |             |        |  |        |  |  |  |
| OUTPUT VOLTAGE SETTING[V]          |                                     | —  |   | —          |            | 8.6 - 9.4   |            | 11.5 - 12.5  |            | 14.4 - 15.6 |  | 17.3 - 18.7   |        | 23.0 - 25.0                     |        | 23.0 - 25.0 |           | 28.8 - 31.2 |        | 46.0 - 50.0 |        |  |        |  |  |  |
| PROTECTION CIRCUIT AND OTHERS      | OVERCURRENT PROTECTION              |  | Works over 105% of rating (-H : peak) and recovers automatically                            |            |            |   |            |              |            |             |  |   |        |                                 |        |             |           |             |        |             |        |  |        |  |  |  |
|                                    | OVERVOLTAGE PROTECTION              |  | 4.00 - 5.25V Works at 115 - 140% of rating  |            |            |   |            |              |            |             |  |   |        |                                 |        |             |           |             |        |             |        |  |        |  |  |  |
|                                    | OPERATING INDICATION                |  | Not provided  |            |            |   |            |              |            |             |  |   |        |                                 |        |             |           |             |        |             |        |  |        |  |  |  |
|                                    | REMOTE SENSING                      |  | Not provided  |            |            |   |            |              |            |             |  |   |        |                                 |        |             |           |             |        |             |        |  |        |  |  |  |
| REMOTE ON/OFF                      |                                     | Option (Refer to Instruction Manual)                 |   |            |            |   |            |              |            |             |  |   |        |                                 |        |             |           |             |        |             |        |  |        |  |  |  |
| ISOLATION                          | INPUT-OUTPUT                        |  | AC3,000V 1minute, Cutoff current = 10mA, DC500V 50MΩ min (At Room Temperature)              |            |            |   |            |              |            |             |  |   |        |                                 |        |             |           |             |        |             |        |  |        |  |  |  |
|                                    | INPUT-FG                            |  | AC2,000V 1minute, Cutoff current = 10mA, DC500V 50MΩ min (At Room Temperature)              |            |            |   |            |              |            |             |  |   |        |                                 |        |             |           |             |        |             |        |  |        |  |  |  |
|                                    | OUTPUT-FG                           |  | AC500V 1minute, Cutoff current = 100mA, DC500V 50MΩ min (At Room Temperature)               |            |            |   |            |              |            |             |  |   |        |                                 |        |             |           |             |        |             |        |  |        |  |  |  |
| ENVIRONMENT                        | OPERATING TEMP.,HUMID.AND ALTIITUDE |  | -10 to +60°C, 20 - 90%RH (Non condensing) (Refer to DERATING CURVE) 3,000m (10,000feet) max |            |            |   |            |              |            |             |  |   |        |                                 |        |             |           |             |        |             |        |  |        |  |  |  |
|                                    | STORAGE TEMP.,HUMID.AND ALTIITUDE   |  | -20 to +75°C, 20 - 90%RH (Non condensing) 9,000m (30,000feet) max                           |            |            |   |            |              |            |             |  |   |        |                                 |        |             |           |             |        |             |        |  |        |  |  |  |
|                                    | VIBRATION                           |  | 10 - 55Hz, 19.6m/s <sup>2</sup> (2G), 3minutes period, 60minutes each along X, Y and Z axis |            |            |   |            |              |            |             |  |   |        |                                 |        |             |           |             |        |             |        |  |        |  |  |  |
|                                    | IMPACT                              |  | 196.1m/s <sup>2</sup> (20G), 11ms, once each X, Y and Z axis                                |            |            |   |            |              |            |             |  |   |        |                                 |        |             |           |             |        |             |        |  |        |  |  |  |
| SAFETY AND NOISE REGULATIONS       | AGENCY APPROVALS                    |  | UL60950-1, EN60950-1, EN50178, CSA C22.2 No.234 Complies with DEN-AN and IEC60950-1         |            |            |   |            |              |            |             |  |   |        |                                 |        |             |           |             |        |             |        |  |        |  |  |  |
|                                    | CONDUCTED NOISE                     |  | Complies with FCC-B, CISPR22-B, EN55022-B, VCCI-B   |            |            |   |            |              |            |             |  |   |        |                                 |        |             |           |             |        |             |        |  |        |  |  |  |
| OTHERS                             | CASE SIZE/WEIGHT                    |  | 62X35X222mm (WxHxD) /360g max (without chassis and cover)                                   |            |            |   |            |              |            |             |  |   |        |                                 |        |             |           |             |        |             |        |  |        |  |  |  |
|                                    | COOLING METHOD                      |  | Convection  |            |            |   |            |              |            |             |  |   |        |                                 |        |             |           |             |        |             |        |  |        |  |  |  |

\*1 Peak load for 20sec. or less is acceptable if the total wattage is less than the rated wattage(24V:103.2W).  
 \*2 Drift is the change in DC output for an eight hour period after a half-hour warm-up at 25°C, with the input voltage held constant at the rated input/output.  
 \*3 ( ) : peak current  
 \*4 Please contact us about safety approvals for the model with option.

\* Avoid prolonged use under over-load.  
 \* Parallel operation with other model is not possible.  
 \* Derating is required when operated with chassis and cover.

## External view



- ※ Weight : 360g or less (Without chassis and cover)
- ※ Tolerance : ± 1
- ※ Dimensions in mm.
- ※ PCB Material : Glass composite (CEM3)
- ※ Chassis and cover is optional.
- ※ Mounting torque : 1.5 N·m (16 kgf·cm) max

| I/O Connector | Mating Connector | Terminal |                      |
|---------------|------------------|----------|----------------------|
| CN1           | B3P5-VH          | VHR-5N   | Chain: SVH-21T-P1.1  |
|               |                  |          | Loose: BVH-21T-P1.1  |
| CN2           | B8P-VH           | VHR-8N   | Chain: SVH-21T-P1.1  |
|               |                  |          | Loose: BVH-21T-P1.1  |
| CN3           | B2B-XH-A         | XHP-2    | Chain: SXH-001T-P0.6 |
|               |                  |          | Loose: BXH-001T-P0.6 |

(Mfr : J.S.T.)

### <PIN CONNECTION>

| CN1 | Pin No. | Input | CN2 | Pin No. | Output | CN3 | Pin No. | Remote ON/OFF |
|-----|---------|-------|-----|---------|--------|-----|---------|---------------|
|     | 1       | AC(L) |     | 1~4     | -V     |     | 1       | RC(+)         |
|     | 2       |       |     | 5~8     | +V     |     | 2       | RC(-)         |
|     | 3       | AC(N) |     |         |        |     |         |               |
|     | 4       |       |     |         |        |     |         |               |
| 5   | FG      |       |     |         |        |     |         |               |

※ Keep drawing current per pin below 5A for CN2.

## Performance data

### ■ STATIC CHARACTERISTICS (LDA100W-5)



### ■ RISE TIME & FALL TIME (LDA100W-5)



### ■ OVERCURRENT CHARACTERISTICS (LDA100W-5)



### ■ DERATING CURVE



# LDA150W

LDA 150 W -5 -□

① ② ③ ④ ⑤



RoHS

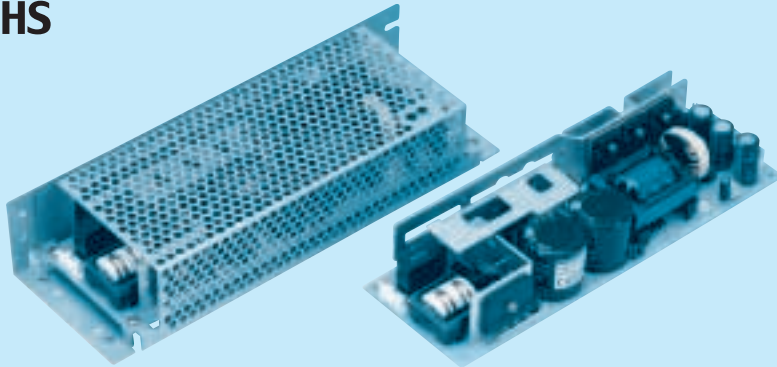

Recommended EMI/EMC Filter  
NAC-06-472



High voltage pulse noise type : NAP series  
Low leakage current type : NAM series  
\*The EMI/EMC Filter is recommended to connect with several devices.

- ① Series name
- ② Output wattage
- ③ Autoranging input
- ④ Output voltage
- ⑤ Optional \*4
- C :with Coating
- G :Low leakage current
- L :with LED
- R :with Remote ON/OFF
- S :with Chassis
- SN :with Chassis & cover
- Y :with Potentiometer

| MODEL                 | LDA150W-3 | LDA150W-5 | LDA150W-9 | LDA150W-12 | LDA150W-15 | LDA150W-18 | LDA150W-24 | LDA150W-24-H | LDA150W-30 | LDA150W-48 |
|-----------------------|-----------|-----------|-----------|------------|------------|------------|------------|--------------|------------|------------|
| MAX OUTPUT WATTAGE[W] | 90        | 150       | 153       | 150        | 150        | 153        | 151.2      | 151.2        | 150        | 144        |
| DC OUTPUT             | *3 3V 30A | 5V 30A    | 9V 17A    | 12V 12.5A  | 15V 10A    | 18V 8.5A   | 24V 6.3A   | 24V 6.3(10)A | 30V 5A     | 48V 3A     |

## SPECIFICATIONS

| MODEL                              | LDA150W-3                           | LDA150W-5  | LDA150W-9   | LDA150W-12 | LDA150W-15                    | LDA150W-18  | LDA150W-24 | LDA150W-24-H | LDA150W-30 | LDA150W-48  |  |                             |        |                                 |        |             |         |             |        |             |        |       |        |       |  |       |  |       |  |       |  |
|------------------------------------|-------------------------------------|--|---|------------|-------------------------------|---|------------|--------------|------------|-------------|--|-----------------------------|--------|---------------------------------|--------|-------------|---------|-------------|--------|-------------|--------|-------|--------|-------|--|-------|--|-------|--|-------|--|
| INPUT                              | VOLTAGE[V]                          |  |   |            |                               |   |            |              |            |             |  | AC 85 - 132 / 170 - 264 1 φ |        |                                 |        |             |         |             |        |             |        |       |        |       |  |       |  |       |  |       |  |
|                                    | CURRENT[A]                          |  | ACIN 100V   |            |                               |   |            |              |            |             |  |                             |        | 3.6typ (Io=100%)                |        |             |         |             |        |             |        |       |        |       |  |       |  |       |  |       |  |
|                                    |                                     |  | ACIN 200V   |            |                               |   |            |              |            |             |  |                             |        | 2.0typ (Io=100%)                |        |             |         |             |        |             |        |       |        |       |  |       |  |       |  |       |  |
|                                    | FREQUENCY[Hz]                       |  |   |            |                               |   |            |              |            |             |  | 47 - 440                    |        |                                 |        |             |         |             |        |             |        |       |        |       |  |       |  |       |  |       |  |
|                                    | EFFICIENCY[%]                       |  |   |            |                               |   |            |              |            |             |  | 75typ                       |        | 79typ                           |        | 79typ       |         | 82typ       |        | 83typ       |        | 84typ |        | 85typ |  | 85typ |  | 85typ |  | 82typ |  |
|                                    | INRUSH CURRENT[A]                   |  | ACIN 200V   |            |                               |   |            |              |            |             |  |                             |        | 30typ (Io=100%) (At cold start) |        |             |         |             |        |             |        |       |        |       |  |       |  |       |  |       |  |
| LEAKAGE CURRENT[mA]                |                                     |  |   |            |                               |   |            |              |            |             | 0.75max (60Hz, According to UL, CSA, VDE and DEN-AN) |                             |        |                                 |        |             |         |             |        |             |        |       |        |       |  |       |  |       |  |       |  |
| OUTPUT                             | VOLTAGE[V]                          |  | 3   |            | 5                             |   | 9          |              | 12         |             | 15   |                             | 18     |                                 | 24     |             | 24      |             | 30     |             | 48     |       |        |       |  |       |  |       |  |       |  |
|                                    | CURRENT[A]                          |  | *1 30   |            | 30                            |   | 17         |              | 12.5       |             | 10   |                             | 8.5    |                                 | 6.3    |             | 6.3(10) |             | 5      |             | 3      |       |        |       |  |       |  |       |  |       |  |
|                                    | LINE REGULATION[mV]                 |  | 20max   |            | 20max                         |   | 36max      |              | 48max      |             | 60max  |                             | 72max  |                                 | 96max  |             | 96max   |             | 120max |             | 192max |       |        |       |  |       |  |       |  |       |  |
|                                    | LOAD REGULATION[mV]                 |  | 40max   |            | 40max                         |   | 100max     |              | 100max     |             | 120max   |                             | 120max |                                 | 150max |             | 150max  |             | 180max |             | 240max |       |        |       |  |       |  |       |  |       |  |
|                                    | RIPPLE[mVp-p]                       |  | 0 to +50°C  |            | 80max                         |   | 80max      |              | 120max     |             | 120max   |                             | 120max |                                 | 120max |             | 220max  |             | 220max |             | 150max |       |        |       |  |       |  |       |  |       |  |
|                                    |                                     |  | -10 - 0°C   |            | 140max                        |   | 140max     |              | 160max     |             | 160max   |                             | 160max |                                 | 160max |             | 160max  |             | 260max |             | 160max |       | 200max |       |  |       |  |       |  |       |  |
|                                    | RIPPLE NOISE[mVp-p]                 |  | 0 to +50°C  |            | 120max                        |   | 120max     |              | 150max     |             | 150max   |                             | 150max |                                 | 150max |             | 150max  |             | 250max |             | 150max |       | 400max |       |  |       |  |       |  |       |  |
|                                    |                                     |  | -10 - 0°C   |            | 160max                        |   | 160max     |              | 180max     |             | 180max   |                             | 180max |                                 | 180max |             | 180max  |             | 280max |             | 180max |       | 600max |       |  |       |  |       |  |       |  |
|                                    | TEMPERATURE REGULATION[mV]          |  | 60max   |            | 60max                         |   | 120max     |              | 150max     |             | 180max   |                             | 200max |                                 | 290max |             | 290max  |             | 360max |             | 560max |       |        |       |  |       |  |       |  |       |  |
|                                    | DRIFT[mV]                           |  | *2 20max  |            | 20max                         |   | 36max      |              | 48max      |             | 60max  |                             | 72max  |                                 | 96max  |             | 96max   |             | 120max |             | 192max |       |        |       |  |       |  |       |  |       |  |
| START-UP TIME[ms]                  |                                     | 200max (ACIN 100V, Io=100%)                          |   |            |                               |   |            |              |            |             |  |                             |        |                                 |        |             |         |             |        |             |        |       |        |       |  |       |  |       |  |       |  |
| HOLD-UP TIME[ms]                   |                                     | 10typ (ACIN 85V, Io=100%) 20typ (ACIN 100V, Io=100%) |   |            |                               |   |            |              |            |             |  |                             |        |                                 |        |             |         |             |        |             |        |       |        |       |  |       |  |       |  |       |  |
| OUTPUT VOLTAGE ADJUSTMENT RANGE[V] |                                     | 2.85 - 3.6   |   | 4.5 - 5.5  |                               | Fixed ("Y"which can be adjusted the output is available as option :9, 12, 15, 18, 24, 30, 48V ±10%) |            |              |            |             |  |                             |        |                                 |        |             |         |             |        |             |        |       |        |       |  |       |  |       |  |       |  |
| OUTPUT VOLTAGE SETTING[V]          |                                     | —  |   | —          |                               | 8.6 - 9.4   |            | 11.5 - 12.5  |            | 14.4 - 15.6 |  | 17.3 - 18.7                 |        | 23.0 - 25.0                     |        | 23.0 - 25.0 |         | 28.5 - 31.5 |        | 46.0 - 50.0 |        |       |        |       |  |       |  |       |  |       |  |
| PROTECTION CIRCUIT AND OTHERS      | OVERCURRENT PROTECTION              |  | Works over 105% of rating (-H : peak) and recovers automatically                            |            |                               |   |            |              |            |             |  |                             |        |                                 |        |             |         |             |        |             |        |       |        |       |  |       |  |       |  |       |  |
|                                    | OVERVOLTAGE PROTECTION              |  | 4.00 - 5.25V  |            | Works at 115 - 140% of rating |   |            |              |            |             |  |                             |        |                                 |        |             |         |             |        |             |        |       |        |       |  |       |  |       |  |       |  |
|                                    | OPERATING INDICATION                |  | Not provided  |            |                               |   |            |              |            |             |  |                             |        |                                 |        |             |         |             |        |             |        |       |        |       |  |       |  |       |  |       |  |
|                                    | REMOTE SENSING                      |  | Not provided  |            |                               |   |            |              |            |             |  |                             |        |                                 |        |             |         |             |        |             |        |       |        |       |  |       |  |       |  |       |  |
| REMOTE ON/OFF                      |                                     | Option (Refer to Instruction Manual)                 |   |            |                               |   |            |              |            |             |  |                             |        |                                 |        |             |         |             |        |             |        |       |        |       |  |       |  |       |  |       |  |
| ISOLATION                          | INPUT-OUTPUT                        |  | AC3,000V 1minute, Cutoff current = 10mA, DC500V 50MΩ min (At Room Temperature)              |            |                               |   |            |              |            |             |  |                             |        |                                 |        |             |         |             |        |             |        |       |        |       |  |       |  |       |  |       |  |
|                                    | INPUT-FG                            |  | AC2,000V 1minute, Cutoff current = 10mA, DC500V 50MΩ min (At Room Temperature)              |            |                               |   |            |              |            |             |  |                             |        |                                 |        |             |         |             |        |             |        |       |        |       |  |       |  |       |  |       |  |
|                                    | OUTPUT-FG                           |  | AC500V 1minute, Cutoff current = 100mA, DC500V 50MΩ min (At Room Temperature)               |            |                               |   |            |              |            |             |  |                             |        |                                 |        |             |         |             |        |             |        |       |        |       |  |       |  |       |  |       |  |
| ENVIRONMENT                        | OPERATING TEMP.,HUMID.AND ALTIITUDE |  | -10 to +60°C, 20 - 90%RH (Non condensing) (Refer to DERATING CURVE) 3,000m (10,000feet) max |            |                               |   |            |              |            |             |  |                             |        |                                 |        |             |         |             |        |             |        |       |        |       |  |       |  |       |  |       |  |
|                                    | STORAGE TEMP.,HUMID.AND ALTIITUDE   |  | -20 to +75°C, 20 - 90%RH (Non condensing) 9,000m (30,000feet) max                           |            |                               |   |            |              |            |             |  |                             |        |                                 |        |             |         |             |        |             |        |       |        |       |  |       |  |       |  |       |  |
|                                    | VIBRATION                           |  | 10 - 55Hz, 19.6m/s <sup>2</sup> (2G), 3minutes period, 60minutes each along X, Y and Z axis |            |                               |   |            |              |            |             |  |                             |        |                                 |        |             |         |             |        |             |        |       |        |       |  |       |  |       |  |       |  |
|                                    | IMPACT                              |  | 196.1m/s <sup>2</sup> (20G), 11ms, once each X, Y and Z axis                                |            |                               |   |            |              |            |             |  |                             |        |                                 |        |             |         |             |        |             |        |       |        |       |  |       |  |       |  |       |  |
| SAFETY AND NOISE REGULATIONS       | AGENCY APPROVALS                    |  | UL60950-1, EN60950-1, EN50178, CSA C22.2 No.234 Complies with DEN-AN and IEC60950-1         |            |                               |   |            |              |            |             |  |                             |        |                                 |        |             |         |             |        |             |        |       |        |       |  |       |  |       |  |       |  |
|                                    | CONDUCTED NOISE                     |  | Complies with FCC-B, CISPR22-B, EN55022-B, VCCI-B   |            |                               |   |            |              |            |             |  |                             |        |                                 |        |             |         |             |        |             |        |       |        |       |  |       |  |       |  |       |  |
| OTHERS                             | CASE SIZE/WEIGHT                    |  | 75×37×222mm (W×H×D) /510g max (without chassis and cover)                                   |            |                               |   |            |              |            |             |  |                             |        |                                 |        |             |         |             |        |             |        |       |        |       |  |       |  |       |  |       |  |
|                                    | COOLING METHOD                      |  | Convection  |            |                               |   |            |              |            |             |  |                             |        |                                 |        |             |         |             |        |             |        |       |        |       |  |       |  |       |  |       |  |

\*1 Peak load for 10sec. or less is acceptable if the total wattage is less than the rated wattage(24V:151.2W).

\*2 Drift is the change in DC output for an eight hour period after a half-hour warm-up at 25°C, with the input voltage held constant at the rated input/output.

\*3 ( ) : peak current

\*4 Please contact us about safety approvals for the model with option.

\* Avoid prolonged use under over-load.

\* Parallel operation with other model is not possible.

\* Derating is required when operated with chassis and cover.



## External view



| I/O Connector | Mating Connector | Terminal  |
|---------------|------------------|---|
| CN1           | B3P5-VH          | VHR-5N<br>Chain: SVH-21T-P1.1<br>Loose: BVH-21T-P1.1  |
| CN2           | B6P-VH           | VHR-6N<br>Chain: SVH-21T-P1.1<br>Loose: BVH-21T-P1.1  |
| CN3           | B7P-VH           | VHR-7N<br>Chain: SVH-21T-P1.1<br>Loose: BVH-21T-P1.1  |
| CN4           | B2B-XH-A         | XHP-2<br>Chain: SXH-001T-P0.6<br>Loose: BXH-001T-P0.6 |

### <PIN CONNECTION>

| Pin No. | Input | Pin No. | Output | Pin No. | Remote ON/OFF |
|---------|-------|---------|--------|---------|---------------|
| 1       | AC(L) | CN2     | 1~6    | 1       | RC(+)         |
| 2       |       |         |        |         |               |
| 3       | AC(N) | CN3     | 1~7    | 2       | RC(-)         |
| 4       |       |         |        |         |               |
| 5       | FG    |         |        |         |               |

※ Keep drawing current per pin below 5A for CN2, CN3.

※ Weight : 510g or less  
(Without chassis and cover)

※ Tolerance : ±1

※ Dimensions in mm.

※ PCB Material : Glass composite (CEM3)

※ Chassis and cover is optional.

※ Chassis and cover is not available to remote ON/OFF unit.

※ Mounting torque : 1.5 N·m (16 kgf·cm) max

(Mfr : J.S.T.)

LDA

## Performance data

### ■ STATIC CHARACTERISTICS (LDA150W-5)



### ■ RISE TIME & FALL TIME (LDA150W-5)



### ■ OVERCURRENT CHARACTERISTICS (LDA150W-5)



### ■ DERATING CURVE





# LDA300W

LDA 300 W -5 -□

① ② ③ ④ ⑤



Recommended EMI/EMC Filter  
NAC-16-472



High voltage pulse noise type : NAP series  
Low leakage current type : NAM series  
\*The EMI/EMC Filter is recommended to connect with several devices.

- ① Series name
- ② Output wattage
- ③ Autoranging input
- ④ Output voltage
- ⑤ Optional \*4
- C :with Coating
- G :Low leakage current
- L :with LED
- R :with Remote ON/OFF
- S :with Chassis
- SNF :with Chassis & cover & fan
- T :Vertical terminal block

| MODEL                 | LDA300W-3 | LDA300W-5 | LDA300W-9 | LDA300W-12 | LDA300W-15 | LDA300W-18 | LDA300W-24 | LDA300W-30 | LDA300W-48 |
|-----------------------|-----------|-----------|-----------|------------|------------|------------|------------|------------|------------|
| MAX OUTPUT WATTAGE[W] | 180       | 300       | 306       | 324        | 330        | 306        | 336        | 300        | 302.4      |
| DC OUTPUT             | 3V 60A    | 5V 60A    | 9V 34A    | 12V 27A    | 15V 22A    | 18V 17A    | 24V 14A    | 30V 10A    | 48V 6.3A   |

## SPECIFICATIONS

|                                    | MODEL  | LDA300W-3   | LDA300W-5        | LDA300W-9 | LDA300W-12 | LDA300W-15 | LDA300W-18 | LDA300W-24 | LDA300W-30 | LDA300W-48 |           |
|------------------------------------|--|---|------------------|-----------|------------|------------|------------|------------|------------|------------|-----------|
| INPUT                              | VOLTAGE[V]   | AC 85 - 132 / 170 - 264 1 φ   |                  |           |            |            |            |            |            |            |           |
|                                    | CURRENT[A]   | ACIN 100V   | 7.5typ (Io=100%) |           |            |            |            |            |            |            |           |
|                                    |  | ACIN 200V   | 4.5typ (Io=100%) |           |            |            |            |            |            |            |           |
|                                    | FREQUENCY[Hz]  | 47 - 440  |                  |           |            |            |            |            |            |            |           |
|                                    | EFFICIENCY[%]  | ACIN 100V   | 72typ            | 78typ     | 78typ      | 80typ      | 81typ      | 81typ      | 83typ      | 83typ      | 83typ     |
|                                    |  | ACIN 200V   | 74typ            | 81typ     | 81typ      | 83typ      | 84typ      | 84typ      | 86typ      | 86typ      | 86typ     |
| INRUSH CURRENT[A]                  | ACIN 100V  | 15/30A typ (Primary/Secondary Surge Current) Io=100% (More than 3sec.to re-start)           |                  |           |            |            |            |            |            |            |           |
|                                    | ACIN 200V  | 30/30typ (Primary/Secondary Surge Current) Io=100% (More than 3sec.to re-start)             |                  |           |            |            |            |            |            |            |           |
| LEAKAGE CURRENT[mA]                | 0.75max (60Hz, According to UL, CSA, VDE and DEN-AN) |   |                  |           |            |            |            |            |            |            |           |
| OUTPUT                             | VOLTAGE[V]   | 3   | 5                | 9         | 12         | 15         | 18         | 24         | 30         | 48         |           |
|                                    | CURRENT[A]   | Forced air  | 60               | 60        | 34         | 27         | 22         | 17         | 14         | 10         | 6.3       |
|                                    |  | Convection*1  | 40 (60)          | 40 (60)   | 23 (34)    | 17 (27)    | 14 (22)    | 12 (17)    | 9 (14)     | 7 (10)     | 4.2 (6.3) |
|                                    | LINE REGULATION[mV]                                  | 20max   | 20max            | 36max     | 48max      | 60max      | 72max      | 96max      | 120max     | 192max     |           |
|                                    | LOAD REGULATION[mV]                                  | 40max   | 40max            | 100max    | 100max     | 120max     | 120max     | 150max     | 180max     | 240max     |           |
|                                    | RIPPLE[mVp-p]  | 0 to +50°C*2  | 80max            | 80max     | 120max     | 120max     | 120max     | 120max     | 120max     | 120max     | 150max    |
|                                    |  | -10 - 0°C*2   | 140max           | 140max    | 160max     | 160max     | 160max     | 160max     | 160max     | 160max     | 200max    |
|                                    | RIPPLE NOISE[mVp-p]                                  | 0 to +50°C*2  | 120max           | 120max    | 150max     | 150max     | 150max     | 150max     | 150max     | 150max     | 400max    |
|                                    |  | -10 - 0°C*2   | 160max           | 160max    | 180max     | 180max     | 180max     | 180max     | 180max     | 180max     | 600max    |
|                                    | TEMPERATURE REGULATION[mV]                           | 60max   | 60max            | 120max    | 150max     | 180max     | 200max     | 290max     | 360max     | 560max     |           |
|                                    | DRIFT[mV]  | *3  | 20max            | 20max     | 36max      | 48max      | 60max      | 72max      | 96max      | 120max     | 192max    |
| START-UP TIME[ms]                  | 200max (ACIN 100V, Io=100%)                          |   |                  |           |            |            |            |            |            |            |           |
| HOLD-UP TIME[ms]                   | 10typ (ACIN 85V, Io=100%) 20typ (ACIN 100V, Io=100%) |   |                  |           |            |            |            |            |            |            |           |
| OUTPUT VOLTAGE ADJUSTMENT RANGE[V] | 2.85 - 3.6 5, 9, 12, 15, 18, 24, 30, 48V ±10%        |   |                  |           |            |            |            |            |            |            |           |
| PROTECTION CIRCUIT AND OTHERS      | OVERCURRENT PROTECTION                               | Works over 105% of rating and recovers automatically  |                  |           |            |            |            |            |            |            |           |
|                                    | OVERVOLTAGE PROTECTION                               | 4.00 - 5.25V Works at 115 - 140% of rating  |                  |           |            |            |            |            |            |            |           |
|                                    | OPERATING INDICATION                                 | Not provided  |                  |           |            |            |            |            |            |            |           |
|                                    | REMOTE SENSING                                       | Provided  |                  |           |            |            |            |            |            |            |           |
| ISOLATION                          | REMOTE ON/OFF  | Option (Refer to Instruction Manual)  |                  |           |            |            |            |            |            |            |           |
|                                    | INPUT-OUTPUT   | AC3.000V 1minute, Cutoff current = 10mA, DC500V 50MΩ min (At Room Temperature)              |                  |           |            |            |            |            |            |            |           |
| ENVIRONMENT                        | INPUT-FG   | AC2.000V 1minute, Cutoff current = 10mA, DC500V 50MΩ min (At Room Temperature)              |                  |           |            |            |            |            |            |            |           |
|                                    | OUTPUT-FG  | AC500V 1minute, Cutoff current = 100mA, DC500V 50MΩ min (At Room Temperature)               |                  |           |            |            |            |            |            |            |           |
| SAFETY AND NOISE REGULATIONS       | OPERATING TEMP.,HUMID.AND ALTIITUDE                  | -10 to +70°C, 20 - 90%RH (Non condensing) (Refer to DERATING CURVE) 3,000m (10,000feet) max |                  |           |            |            |            |            |            |            |           |
|                                    | STORAGE TEMP.,HUMID.AND ALTIITUDE                    | -20 to +75°C, 20 - 90%RH (Non condensing) 9,000m (30,000feet) max                           |                  |           |            |            |            |            |            |            |           |
|                                    | VIBRATION  | 10 - 55Hz, 19.6m/s <sup>2</sup> (2G), 3minutes period, 60minutes each along X, Y and Z axis |                  |           |            |            |            |            |            |            |           |
| OTHERS                             | IMPACT   | 196.1m/s <sup>2</sup> (20G), 11ms, once each X, Y and Z axis                                |                  |           |            |            |            |            |            |            |           |
|                                    | AGENCY APPROVALS                                     | UL60950-1, C-UL, EN60950-1, EN50178 Complies with DEN-AN and IEC60950-1                     |                  |           |            |            |            |            |            |            |           |
|                                    | CONDUCTED NOISE                                      | Complies with FCC-B, CISPR22-B, EN55022-B, VCCI-B   |                  |           |            |            |            |            |            |            |           |
|                                    | CASE SIZE/WEIGHT                                     | 108×50×255mm (W×H×D) /1kg max (without terminal block)                                      |                  |           |            |            |            |            |            |            |           |
|                                    | COOLING METHOD                                       | Convection / Forced air (Refer to DERATING CURVE)   |                  |           |            |            |            |            |            |            |           |

\*1 Peak load for 30sec. or less is acceptable if the total wattage is less than the rated wattage.  
 \*2 This is the value that measured on measuring board with capacitor of 22 μF within 150mm from output terminal.  
 \*3 Drift is the change in DC output for an eight hour period after a half-hour warm-up at 25°C, with the input voltage held constant at the rated input/output.  
 \*4 Please contact us about safety approvals for the model with option.  
 \* Parallel operation with other model is not possible.  
 \* Derating is required when operated with chassis and cover.

## External view



Standard Model

Horizontal type

Vertical type

Optional Model "-T"  
(Ex. LDA300W-5-T)

Optional Model "-SNF"  
(EX. LDA300W-5-SNF)

Applicable options

| Terminal Block Horizontal type |                        | Terminal Block Vertical type |               |
|--------------------------------|------------------------|------------------------------|---------------|
| -S                             | Available              | -ST                          | Available     |
| -SN                            | Not Available          | -SNT                         | Not Available |
| -SNF                           | Available 5V, 12V, 24V | -SNFT                        | Not Available |

CN1 (Connector for Sensing)  
Type: B4B-XH-A

| Pin No. | Function            |
|---------|---------------------|
| 1       | -M                  |
| 2       | -S (Remote Sensing) |
| 3       | +S (Remote Sensing) |
| 4       | +M                  |

Mating Housing & Pin  
Mfr: J. S. T.  
XHP-4 (BXH-001T-P0.6 or SXH-001T-P0.6)

CN2 (Optional connector for Remote ON/OFF: optional)  
Type: B2B-XH-A

| Pin No. | Function |
|---------|----------|
| 1       | RC (+)   |
| 2       | RC (-)   |

Mating Housing & Pin  
Mfr: J. S. T.  
XHP-2 (BXH-001T-P0.6 or SXH-001T-P0.6)

- ※ Weight : 1kg or less (without casecover)
- ※ Tolerance : ±1
- ※ Dimensions : mm.
- ※ PCB Material : Glass composite (CEM3)
- ※ Keep drawing current per pin below 20A for TB2
- ※ Mounting torque : 1.5N·m (16kgf·cm) max

LDA

## Performance data

### ■ STATIC CHARACTERISTICS (LDA300W-5)



### ■ RISE TIME & FALL TIME (LDA300W-5)



### ■ OVERCURRENT CHARACTERISTICS (LDA300W-5)



### ■ DERATING CURVE



# Mouser Electronics

Authorized Distributor

Click to View Pricing, Inventory, Delivery & Lifecycle Information:

## Cosel:

[S-LDA300](#) [N-LDA75](#) [N-LDA150](#) [N-LDA10](#) [S-LDA15](#) [N-LDA30](#) [S-LDA150](#) [S-LDA50](#) [S-LDA10](#) [N-LDA100](#) [S-LDA100](#) [N-LDA50](#) [S-LDA75](#) [S-LDA30](#) [N-LDA15](#) [LDA50F-5-SNR](#) [LDA100W-24-H](#) [LDA100W-30-SNY](#) [LDA30F-24-SNG](#) [LDA75F-12-S](#) [LDA50F-12-Y](#) [LDA75F-24-SY](#) [LDA150W-9-RY](#) [LDA300W-5-RT](#) [LDA10F-12-SNY](#) [LDA150W-48-SN](#) [LDA100W-48](#) [LDA30F-12-SY](#) [LDA50F-24-GY](#) [LDA300W-3-CT](#) [LDA300W-24-R](#) [LDA150W-12-CR](#) [LDA75F-5-CY](#) [LDA10F-24-M](#) [LDA50F-24-S](#) [LDA30F-24](#) [LDA100W-15-RY](#) [LDA15F-5-GY](#) [LDA150W-18](#) [LDA15F-15-GY](#) [LDA10F-3-SNC](#) [LDA75F-12-M](#) [LDA150W-24-CR](#) [LDA50F-12-R](#) [LDA75F-24-R](#) [LDA75F-30-SNR](#) [LDA50F-3-M](#) [LDA30F-24-SN](#) [LDA15F-3-S](#) [LDA75F-5-V](#) [LDA75F-15-Y](#) [LDA300W-3-R](#) [LDA10F-15-SNQ](#) [LDA50F-24-SN](#) [LDA100W-9-Y](#) [LDA50F-15-SN](#) [LDA150W-30-TD28](#) [LDA300W-48-S](#) [LDA30F-15-SNY](#) [LDA50F-9-SNC](#) [LDA10F-5-S](#) [LDA75F-9-SN](#) [LDA150W-5-L](#) [LDA150W-30](#) [LDA300W-30-CT](#) [LDA150W-12-Y](#) [LDA100W-48-SNY](#) [LDA150W-3-C](#) [LDA30F-5-Y](#) [LDA75F-12-SNY](#) [LDA30F-12-G](#) [LDA75F-24-C](#) [LDA100W-12-SNRY](#) [LDA300W-24-C](#) [LDA100W-24-SNH](#) [LDA15F-5-Q](#) [LDA50F-30](#) [LDA75F-15](#) [LDA75F-9-Y](#) [LDA50F-5-G](#) [LDA30F-3-SNC](#) [LDA15F-24-CG](#) [LDA10F-5-SNC](#) [LDA30F-3-GD3.3](#) [LDA50F-24-CR](#) [LDA100W-48-CY](#) [LDA100W-5-CR](#) [LDA150W-24-SHY](#) [LDA10F-24-SNY](#) [LDA75F-3-SN](#) [LDA50F-30-SNRY](#) [LDA10F-5-SNY](#) [LDA300W-24-L](#) [LDA100W-5-SNC](#) [LDA300W-30-R](#) [LDA15F-12-S](#) [LDA100W-24-HY](#) [LDA50F-24-HY](#) [LDA50F-5-Y](#) [LDA15F-12-Y](#)

Компания «Океан Электроники» предлагает заключение долгосрочных отношений при поставках импортных электронных компонентов на взаимовыгодных условиях!

Наши преимущества:

- Поставка оригинальных импортных электронных компонентов напрямую с производств Америки, Европы и Азии, а так же с крупнейших складов мира;
- Широкая линейка поставок активных и пассивных импортных электронных компонентов (более 30 млн. наименований);
- Поставка сложных, дефицитных, либо снятых с производства позиций;
- Оперативные сроки поставки под заказ (от 5 рабочих дней);
- Экспресс доставка в любую точку России;
- Помощь Конструкторского Отдела и консультации квалифицированных инженеров;
- Техническая поддержка проекта, помощь в подборе аналогов, поставка прототипов;
- Поставка электронных компонентов под контролем ВП;
- Система менеджмента качества сертифицирована по Международному стандарту ISO 9001;
- При необходимости вся продукция военного и аэрокосмического назначения проходит испытания и сертификацию в лаборатории (по согласованию с заказчиком);
- Поставка специализированных компонентов военного и аэрокосмического уровня качества (Xilinx, Altera, Analog Devices, Intersil, Interpoint, Microsemi, Actel, Aeroflex, Peregrine, VPT, Syfer, Eurofarad, Texas Instruments, MS Kennedy, Miteq, Cobham, E2V, MA-COM, Hittite, Mini-Circuits, General Dynamics и др.);

Компания «Океан Электроники» является официальным дистрибьютором и эксклюзивным представителем в России одного из крупнейших производителей разъемов военного и аэрокосмического назначения «JONHON», а так же официальным дистрибьютором и эксклюзивным представителем в России производителя высокотехнологичных и надежных решений для передачи СВЧ сигналов «FORSTAR».



## JONHON

«JONHON» (основан в 1970 г.)

Разъемы специального, военного и аэрокосмического назначения:

(Применяются в военной, авиационной, аэрокосмической, морской, железнодорожной, горно- и нефтедобывающей отраслях промышленности)

«FORSTAR» (основан в 1998 г.)

ВЧ соединители, коаксиальные кабели,  
кабельные сборки и микроволновые компоненты:

(Применяются в телекоммуникациях гражданского и специального назначения, в средствах связи, РЛС, а так же военной, авиационной и аэрокосмической отраслях промышленности).



Телефон: 8 (812) 309-75-97 (многоканальный)

Факс: 8 (812) 320-03-32

Электронная почта: [ocean@oceanchips.ru](mailto:ocean@oceanchips.ru)

Web: <http://oceanchips.ru/>

Адрес: 198099, г. Санкт-Петербург, ул. Калинина, д. 2, корп. 4, лит. А