

Wide Range of Locking-type Models Available

- Character height of 4.8 or 3.2 mm makes for easy-to-view display.
- Installation is easy with snap-in mounting.
- The series includes a complete range of locking-type models that prevent accidental operation.

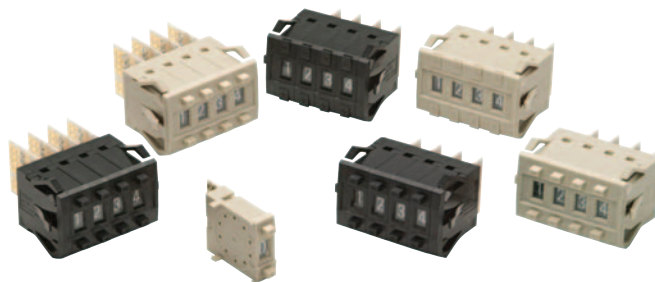

Ordering Information

Switches (Single Switch Units)

Model	A7BS		A7BS-20□-S	
	Snap-in (front mounting)		Snap-in (front mounting)	
Classification (See note 1.)			 With external stoppers	
Character height	Decimal: 4.8 mm Hexadecimal: 3.2 mm		4.8 mm	
Terminals	Solder terminals *1			
Color	Light gray	Black	Light gray	Black
Output code number	Model			
06 (binary coded decimal)	A7BS-206 *2	A7BS-206-1 *2	A7BS-206-S	A7BS-206-S-1
07 (binary coded decimal, with component adding provision) *3	A7BS-207 *2	A7BS-207-1 *2	A7BS-207-S	A7BS-207-S-1
54 (binary coded hexadecimal)	A7BS-254	A7BS-254-1	---	---
55 (binary coded hexadecimal, with component-adding provision) *3	A7BS-255	A7BS-255-1	---	---

Model	A7BL	
	Snap-in (front mounting)	
Classification (See note 1.)	 Locking type	
Character height	4.8 mm	
Terminals	Solder terminals *1	
Color	Light gray	Black
Output code number	Model	
06 (binary coded decimal)	A7BL-206 *2	A7BL-206-1 *2
07 (binary coded decimal, with component-adding provision) *3	A7BL-207 *2	A7BL-207-1 *2

Note: 1. The classification diagrams show 4 Switch Units combined with End Caps to create 4-digit displays.

2. The model numbers given above are for Switch Units.

3. Models with +, - displays can also be produced. Add "-PM" after the "206" or "207" in the model number (e.g., A7BS-206-PM or A7BS-207-PM-1).

*1. For models with PCB terminals, add "-P2" to the model number (e.g., A7BS-207-P2-1).

*2. Models with internal stoppers are also available. Add "-S□□" after the "206" or "207" in the model number and specify the display range in the □□. For example, to specify the range 0 to 6, add "-S06" to the model number (e.g., A7BS-206-S06-1).

For structural reasons, models with stoppers cannot be manufactured for the A7BS-254 and A7BS-255.

*3. Models with diodes are available. Add "-D" to the model number (e.g., A7BS-207-D or A7BS-207-D-1).

Accessories (Order Separately)

Use accessories, such as End Caps, Spacers, and Connectors with the Switch Units.

End Caps, Spare Units, and Connectors

Accessory	Color	Light gray	Black
End Caps (1 pair)		A7B-M	A7B-M-1
Spacer		A7B-P□ (See note.)	A7B-P□-1 (See note.)
Connectors	Solder terminals	A7B-C	
	PCB terminals	A7B-CP	

Note: The □ in the Spacer model number stands for a letter in the range A to U. (Refer to the table in the following explanation about Spacers.)

End Caps

End Caps are used on the Switch Units at each end and allow all the Switch Units to be securely mounted to a panel. They come in pairs, one for the left and one for the right.

Spacers

- Spacers are used for creating extra space or gaps between the Switch Units and have the same dimensions as the Switch Units themselves.
- There are also Spacers with engraved characters or symbols that can be used for indicating units, such as time and length. (Refer to the following table.) Consult your OMRON representative for details.

Symbol	A	B	C	D	E	F	G
Stamp	No designation	SEC	MIN	H	g	kg	mm

Symbol	H	J	K	L	Q	T	U
Stamp	cm	m	°C	PCS	x 10 SEC	0	•

Specifications

Switching capacity (resistive load)		3.3 to 28 VDC or 50 VAC 1 mA to 0.1 A
Continuous carry current		1 A max.
Contact resistance		300 mΩ max.
Insulation resistance	Between non-connected terminals	10 MΩ min. (at 500 VDC)
	Between terminal and non-current carrying part	1,000 MΩ min. (at 500 VDC)
Dielectric strength	Between non-connected terminals	600 VAC, 50/60 Hz for 1 min
	Between terminal and non-current carrying part	1,000 VAC, 50/60 Hz for 1 min
Vibration resistance		10 to 55 Hz, 1.5-mm double amplitude
Shock resistance		490 m/s ² min.
Durability	Mechanical	100,000 operations min.
	Electrical	50,000 operations min.
Ambient temperature		Operating: -10°C to 65°C (with no icing) Storage: -20°C to 80°C
Ambient humidity		Operating: 45% to 85%
Max. operating force		5.39 N max.

Dimensions

Switches

A7BS-2□□(-1)
Solder Terminals

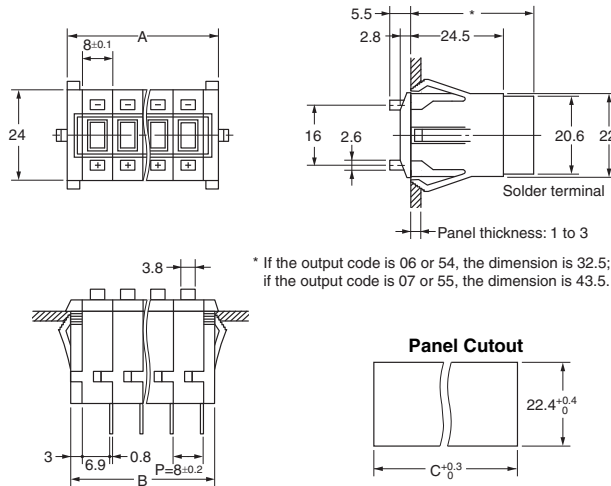

Number of Switches (n)	Size A (n x 8 + 8)	Size B (n x 8 + 6)	Size C
1	16	14	14.4
2	24	22	22.4
3	32	30	30.4
4	40	38	38.4
5	48	46	46.8
6	56	54	54.8
7	64	62	62.8
8	72	70	70.8
9	80	78	78.8
10	88	86	86.8

Note: 1. The dimensions above include both End Caps, and will increase 8 mm for each Spacer inserted.
2. Unless otherwise specified, a tolerance of ±0.4 mm applies to all dimensions. The tolerance for multiple connection is ±(number of units x 0.4) mm.

Thumbwheel Switches with External Stoppers:

A7BS-20□-S(-1)

- Use A7BS-S Stopper Pins to make dial display restrictions for these Switches.
- Insert the Stopper Pins in the positions required to give the desired display range. For example, for a display range of 0 to 5, insert a Stopper Pin at position 1 (see following diagram) to stop the display from going above 5 when the (+) button is pressed, and insert a Stopper Pin at position 2 to stop the display from going below 0 when the (-) button is pressed.

Refer to page 7 for details.

Stopper Pins

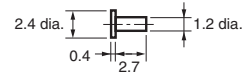

Note: 1. Two pins constitute one set.
2. The first shipment is free and is attached to the Switch. Order the A7BS-S separately if it is required for maintenance.

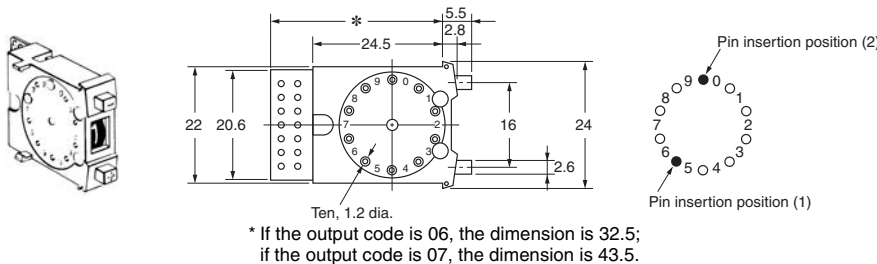

A7BL-206(-1)
A7BL-207(-1)
Solder Terminals,
Locking Models

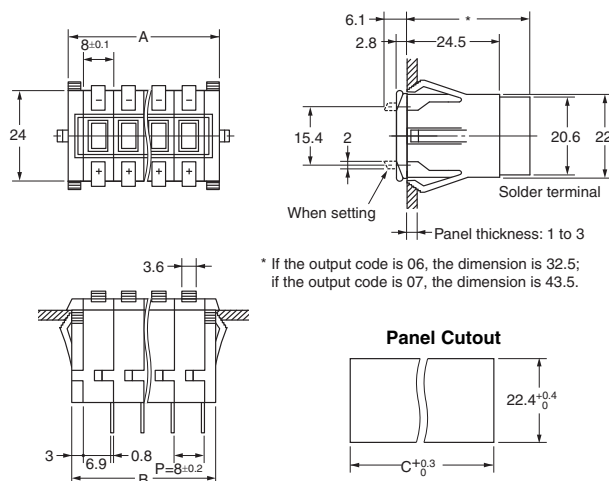
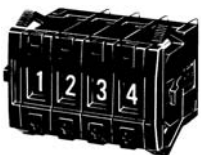

Number of Switches (n)	Size A (n x 8 + 8)	Size B (n x 8 + 6)	Size C
1	16	14	14.4
2	24	22	22.4
3	32	30	30.4
4	40	38	38.4
5	48	46	46.8
6	56	54	54.8
7	64	62	62.8
8	72	70	70.8
9	80	78	78.8
10	88	86	86.8

Note: 1. The dimensions above include both End Caps, and will increase 8 mm for each Spacer inserted.
2. Unless otherwise specified, a tolerance of ±0.4 mm applies to all dimensions. The tolerance for multiple connection is ±(number of units x 0.4) mm.

Accessories (Order Separately)

End Caps for Push-operated Switches

A7B-M(-1) Snap-in Panel Mounting

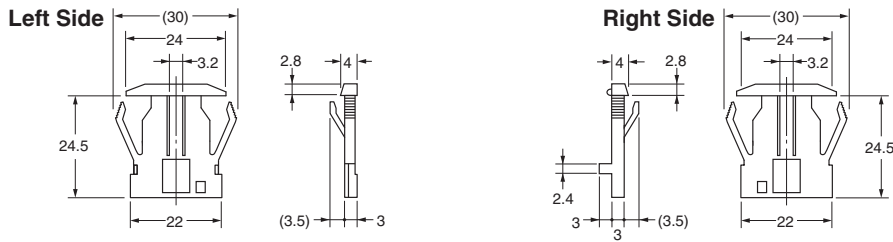

Spacers for Push-operated Switches

A7B-P□(-1) Snap-in Panel Mounting

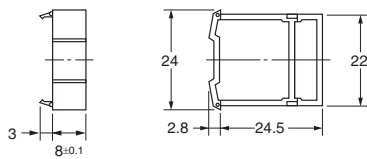

The □ in the Spacer model number stands for a letter in the range A to U. (Refer to the table under the explanation about Spacers on page 2.)

Note: Unless otherwise indicated, dimensional tolerances for dimensions in the models above are ± 0.4 mm.

Connectors (These devices allow Switches to be quickly removed for maintenance and inspection of connectivity, and quickly re-installed.)

**A7B-C
Solder Terminals**

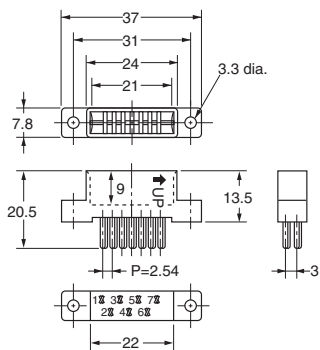
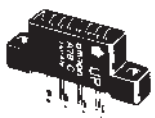

Inserting Connectors

Insert Connectors with the "UP" arrow pointing up.

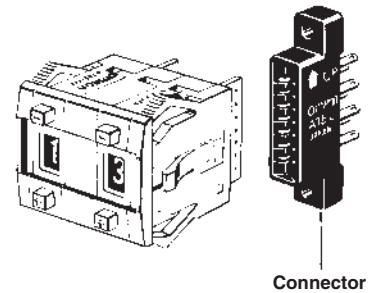

**A7B-CP
PCB Terminals**

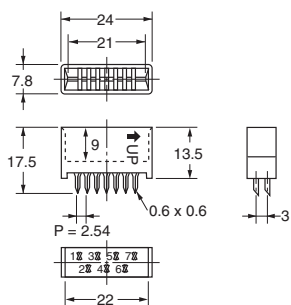

Note: Unless otherwise indicated, dimensional tolerances for dimensions in the models above are ± 0.4 mm.

Output Codes/Terminals

- Switches with output codes 06 or 07 both use binary coded decimal but Switches with output code 07 have a component-adding provision. Similarly, Switches with output codes 54 or 55 both use binary coded hexadecimal but Switches with output code 55 have a component-adding provision.

- How to Read Output Codes
For example, when the dial position is “3,” the common terminal C on the Switch is connected to terminals 1 and 2. When the Switch is inserted into the Connector, the common terminal C becomes connector terminal 2, and terminals 1 and 2 become connector terminals 4 and 5 respectively.

Output code number	Terminals	Output codes																																																																																
06	<p>Fourteen, 1-dia. holes</p>	<table border="1"> <thead> <tr> <th>Model</th> <th>Switch Unit or Connector</th> <th>Common terminal number</th> <th colspan="4">Terminals connected to common</th> </tr> </thead> <tbody> <tr> <td></td> <td>Switch Unit</td> <td>C</td> <td>1</td> <td>2</td> <td>4</td> <td>8</td> </tr> <tr> <td>06</td> <td>Connector</td> <td>2</td> <td>4</td> <td>5</td> <td>6</td> <td>7</td> </tr> <tr> <td>07</td> <td>Connector</td> <td>1</td> <td>4</td> <td>5</td> <td>6</td> <td>7</td> </tr> <tr> <td rowspan="10">Dial</td> <td rowspan="10"></td> <td>0</td> <td></td> <td></td> <td></td> <td></td> </tr> <tr> <td>1</td> <td>●</td> <td></td> <td></td> <td></td> </tr> <tr> <td>2</td> <td></td> <td>●</td> <td></td> <td></td> </tr> <tr> <td>3</td> <td>●</td> <td>●</td> <td></td> <td></td> </tr> <tr> <td>4</td> <td></td> <td></td> <td>●</td> <td></td> </tr> <tr> <td>5</td> <td>●</td> <td></td> <td>●</td> <td></td> </tr> <tr> <td>6</td> <td></td> <td>●</td> <td>●</td> <td></td> </tr> <tr> <td>7</td> <td>●</td> <td>●</td> <td>●</td> <td></td> </tr> <tr> <td>8</td> <td></td> <td></td> <td></td> <td>●</td> </tr> <tr> <td>9</td> <td>●</td> <td></td> <td></td> <td>●</td> </tr> </tbody> </table> <p>Note: The solid dot ● indicates that the internal switch is ON (i.e., connected to the common terminal).</p>	Model	Switch Unit or Connector	Common terminal number	Terminals connected to common					Switch Unit	C	1	2	4	8	06	Connector	2	4	5	6	7	07	Connector	1	4	5	6	7	Dial		0					1	●				2		●			3	●	●			4			●		5	●		●		6		●	●		7	●	●	●		8				●	9	●			●
		Model	Switch Unit or Connector	Common terminal number	Terminals connected to common																																																																													
	Switch Unit	C	1	2	4	8																																																																												
06	Connector	2	4	5	6	7																																																																												
07	Connector	1	4	5	6	7																																																																												
Dial		0																																																																																
		1	●																																																																															
		2		●																																																																														
		3	●	●																																																																														
		4			●																																																																													
		5	●		●																																																																													
		6		●	●																																																																													
		7	●	●	●																																																																													
		8				●																																																																												
		9	●			●																																																																												
07	<p>Twenty-eight, 1-dia. holes</p> <p>Component-adding provision</p>																																																																																	

Output code number	Terminals	Output codes																																																																																																						
54	 <p>Fourteen, 1-dia. holes</p>	<table border="1"> <thead> <tr> <th data-bbox="751 338 831 389">Model</th> <th data-bbox="831 338 991 389">Switch Unit or Connector</th> <th data-bbox="991 338 1142 389">Common terminal number</th> <th colspan="4" data-bbox="1142 338 1449 389">Terminals connected to common</th> </tr> </thead> <tbody> <tr> <td></td> <td>Switch Unit</td> <td>C</td> <td>1</td> <td>2</td> <td>4</td> <td>8</td> </tr> <tr> <td>54</td> <td>Connector</td> <td>2</td> <td>4</td> <td>5</td> <td>6</td> <td>7</td> </tr> <tr> <td>55</td> <td>Connector</td> <td>1</td> <td>4</td> <td>5</td> <td>6</td> <td>7</td> </tr> </tbody> </table>	Model	Switch Unit or Connector	Common terminal number	Terminals connected to common					Switch Unit	C	1	2	4	8	54	Connector	2	4	5	6	7	55	Connector	1	4	5	6	7																																																																										
Model	Switch Unit or Connector	Common terminal number	Terminals connected to common																																																																																																					
	Switch Unit	C	1	2	4	8																																																																																																		
54	Connector	2	4	5	6	7																																																																																																		
55	Connector	1	4	5	6	7																																																																																																		
55	 <p>Twenty-eight, 1-dia. holes</p> <p>Component-adding provision</p>	<table border="1"> <thead> <tr> <th data-bbox="751 712 831 763">Dial</th> <th data-bbox="831 712 991 763">Common terminal number</th> <th colspan="4" data-bbox="1142 712 1449 763">Terminals connected to common</th> </tr> </thead> <tbody> <tr> <td></td> <td>0</td> <td></td> <td></td> <td></td> <td></td> </tr> <tr> <td></td> <td>1</td> <td>●</td> <td></td> <td></td> <td></td> </tr> <tr> <td></td> <td>2</td> <td></td> <td>●</td> <td></td> <td></td> </tr> <tr> <td></td> <td>3</td> <td>●</td> <td>●</td> <td></td> <td></td> </tr> <tr> <td></td> <td>4</td> <td></td> <td></td> <td>●</td> <td></td> </tr> <tr> <td></td> <td>5</td> <td>●</td> <td></td> <td>●</td> <td></td> </tr> <tr> <td></td> <td>6</td> <td></td> <td>●</td> <td>●</td> <td></td> </tr> <tr> <td></td> <td>7</td> <td>●</td> <td>●</td> <td>●</td> <td></td> </tr> <tr> <td></td> <td>8</td> <td></td> <td></td> <td></td> <td>●</td> </tr> <tr> <td></td> <td>9</td> <td>●</td> <td></td> <td></td> <td>●</td> </tr> <tr> <td></td> <td>A</td> <td></td> <td>●</td> <td></td> <td>●</td> </tr> <tr> <td></td> <td>B</td> <td>●</td> <td>●</td> <td></td> <td>●</td> </tr> <tr> <td></td> <td>C</td> <td></td> <td></td> <td>●</td> <td>●</td> </tr> <tr> <td></td> <td>D</td> <td>●</td> <td></td> <td>●</td> <td>●</td> </tr> <tr> <td></td> <td>E</td> <td></td> <td>●</td> <td>●</td> <td>●</td> </tr> <tr> <td></td> <td>F</td> <td>●</td> <td>●</td> <td>●</td> <td>●</td> </tr> </tbody> </table> <p>Note: 1. The solid dot ● indicates that the internal switch is ON (i.e., connected to the common terminal).</p>	Dial	Common terminal number	Terminals connected to common					0						1	●					2		●				3	●	●				4			●			5	●		●			6		●	●			7	●	●	●			8				●		9	●			●		A		●		●		B	●	●		●		C			●	●		D	●		●	●		E		●	●	●		F	●	●	●	●
Dial	Common terminal number	Terminals connected to common																																																																																																						
	0																																																																																																							
	1	●																																																																																																						
	2		●																																																																																																					
	3	●	●																																																																																																					
	4			●																																																																																																				
	5	●		●																																																																																																				
	6		●	●																																																																																																				
	7	●	●	●																																																																																																				
	8				●																																																																																																			
	9	●			●																																																																																																			
	A		●		●																																																																																																			
	B	●	●		●																																																																																																			
	C			●	●																																																																																																			
	D	●		●	●																																																																																																			
	E		●	●	●																																																																																																			
	F	●	●	●	●																																																																																																			

Ordering Procedure

Place orders as shown in the example below, specifying the model and number. Standard products are not factory-assembled for shipment. Contact your OMRON representative for details on ordering factory-assembled sets.

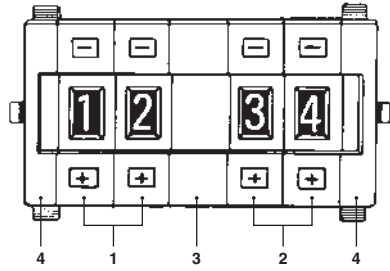

1. A7BS-206 (Switch Unit): 2 pieces
2. A7BS-207 (Switch Unit): 2 pieces
3. A7B-PA (Spacer): 1 piece
4. A7B-M (End Caps): 1 pair

Safety Precautions

Refer to *Precautions for Correct Use* on page in the *Technical Guide for Thumbwheel Switches*.

Precautions for Correct Use

Handling

- The molded components of the Switch use polyacetal resin and ABS resin. It is recommended that alcohol is used to wipe off dirt and smudges from the molded components. Take care to prevent the alcohol from getting inside.
- A7BS/A7BL Thumbwheel Switches are not drip-proof. Do not use them in areas subject to water or oil.
- Do not allow solder flux or alcohol to enter the Switch.

Setting Numbers

Locking Type

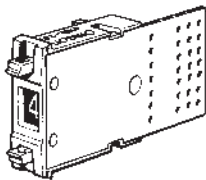

- Set with the setting button by raising it.
- Return the button to its original position after setting. It is then locked to prevent rotation, and the set numbers will not change accidentally.
- To separate the Switches, use a flat-blade screwdriver as shown in the following figure to release the hooks on the top and bottom and then separate the Switches. Be careful not to bend the hooks.

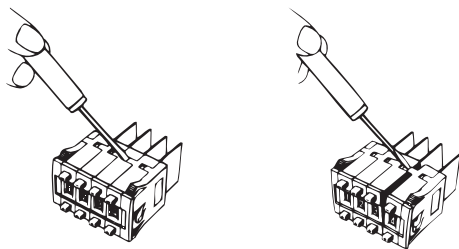

Models with External Stoppers (A7BS-20□-S)

With the A7BS-20□-S, any range can be set externally using the Stopper Pin. Insert the Stopper Pin using the following procedure:

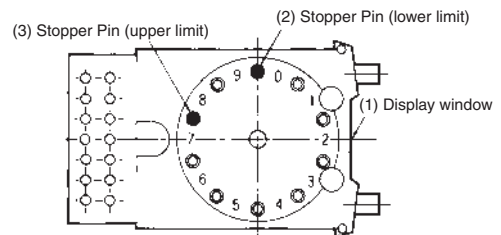

Example: To Display the Range 0 to 7

1. Any number within the range of (0 to 7) can be chosen to limit the numbers displayed in the display window. (In this example, 8 and 9 are outside of this range.)
2. First, insert the Stopper Pin in the hole in front of the lower limit ("0") for the number to be defined.
3. Next, inset the Stopper Pin in the hole past the upper limit ("7") for the number to be defined. (The Stopper Pins then surround the exact range to be defined.)
4. Confirm that the (+) push-button can no longer be pushed after reaching the upper limit of ("7").
5. Confirm that the (-) push-button can no longer be pushed after reaching the lower limit of ("0"). This completes the setting.



Terms and Conditions Agreement

Read and understand this catalog.

Please read and understand this catalog before purchasing the products. Please consult your OMRON representative if you have any questions or comments.

Warranties.

(a) Exclusive Warranty. Omron's exclusive warranty is that the Products will be free from defects in materials and workmanship for a period of twelve months from the date of sale by Omron (or such other period expressed in writing by Omron). Omron disclaims all other warranties, express or implied.

(b) Limitations. OMRON MAKES NO WARRANTY OR REPRESENTATION, EXPRESS OR IMPLIED, ABOUT NON-INFRINGEMENT, MERCHANTABILITY OR FITNESS FOR A PARTICULAR PURPOSE OF THE PRODUCTS. BUYER ACKNOWLEDGES THAT IT ALONE HAS DETERMINED THAT THE PRODUCTS WILL SUITABLY MEET THE REQUIREMENTS OF THEIR INTENDED USE.

Omron further disclaims all warranties and responsibility of any type for claims or expenses based on infringement by the Products or otherwise of any intellectual property right. (c) Buyer Remedy. Omron's sole obligation hereunder shall be, at Omron's election, to (i) replace (in the form originally shipped with Buyer responsible for labor charges for removal or replacement thereof) the non-complying Product, (ii) repair the non-complying Product, or (iii) repay or credit Buyer an amount equal to the purchase price of the non-complying Product; provided that in no event shall Omron be responsible for warranty, repair, indemnity or any other claims or expenses regarding the Products unless Omron's analysis confirms that the Products were properly handled, stored, installed and maintained and not subject to contamination, abuse, misuse or inappropriate modification. Return of any Products by Buyer must be approved in writing by Omron before shipment. Omron Companies shall not be liable for the suitability or unsuitability or the results from the use of Products in combination with any electrical or electronic components, circuits, system assemblies or any other materials or substances or environments. Any advice, recommendations or information given orally or in writing, are not to be construed as an amendment or addition to the above warranty.

See <http://www.omron.com/global/> or contact your Omron representative for published information.

Limitation on Liability; Etc.

OMRON COMPANIES SHALL NOT BE LIABLE FOR SPECIAL, INDIRECT, INCIDENTAL, OR CONSEQUENTIAL DAMAGES, LOSS OF PROFITS OR PRODUCTION OR COMMERCIAL LOSS IN ANY WAY CONNECTED WITH THE PRODUCTS, WHETHER SUCH CLAIM IS BASED IN CONTRACT, WARRANTY, NEGLIGENCE OR STRICT LIABILITY.

Further, in no event shall liability of Omron Companies exceed the individual price of the Product on which liability is asserted.

Suitability of Use.

Omron Companies shall not be responsible for conformity with any standards, codes or regulations which apply to the combination of the Product in the Buyer's application or use of the Product. At Buyer's request, Omron will provide applicable third party certification documents identifying ratings and limitations of use which apply to the Product. This information by itself is not sufficient for a complete determination of the suitability of the Product in combination with the end product, machine, system, or other application or use. Buyer shall be solely responsible for determining appropriateness of the particular Product with respect to Buyer's application, product or system. Buyer shall take application responsibility in all cases.

NEVER USE THE PRODUCT FOR AN APPLICATION INVOLVING SERIOUS RISK TO LIFE OR PROPERTY OR IN LARGE QUANTITIES WITHOUT ENSURING THAT THE SYSTEM AS A WHOLE HAS BEEN DESIGNED TO ADDRESS THE RISKS, AND THAT THE OMRON PRODUCT(S) IS PROPERLY RATED AND INSTALLED FOR THE INTENDED USE WITHIN THE OVERALL EQUIPMENT OR SYSTEM.

Programmable Products.

Omron Companies shall not be responsible for the user's programming of a programmable Product, or any consequence thereof.

Performance Data.

Data presented in Omron Company websites, catalogs and other materials is provided as a guide for the user in determining suitability and does not constitute a warranty. It may represent the result of Omron's test conditions, and the user must correlate it to actual application requirements. Actual performance is subject to the Omron's Warranty and Limitations of Liability.

Change in Specifications.

Product specifications and accessories may be changed at any time based on improvements and other reasons. It is our practice to change part numbers when published ratings or features are changed, or when significant construction changes are made. However, some specifications of the Product may be changed without any notice. When in doubt, special part numbers may be assigned to fix or establish key specifications for your application. Please consult with your Omron's representative at any time to confirm actual specifications of purchased Product.

Errors and Omissions.

Information presented by Omron Companies has been checked and is believed to be accurate; however, no responsibility is assumed for clerical, typographical or proofreading errors or omissions.

Mouser Electronics

Authorized Distributor

Click to View Pricing, Inventory, Delivery & Lifecycle Information:

Omron:

[A7BS-206](#) [A7BS-254-1](#) [A7B-CP](#) [A7B-PA-1](#) [A7B-M-1](#) [A7BS-206-S-1](#) [A7BS-206-1](#) [A7BS-207-S-1](#) [A7BS-207-1](#)
[A7BS-206-S](#) [A7B-C](#) [A7BL-206](#) [A7BL-206-1](#) [A7BL-206-PM](#) [A7BL-206-PM-1](#) [A7BL-207](#) [A7BL-207-1](#) [A7B-M](#) [A7B-](#)
[PA](#) [A7B-PU](#) [A7B-PU-1](#) [A7BS-203](#) [A7BS-203-1](#) [A7BS-206-10](#) [A7BS-206-10-1](#) [A7BS-206-PM](#) [A7BS-206-PM-1](#)
[A7BS-206-S04](#) [A7BS-207](#) [A7BS-207-PM](#) [A7BS-207-PM-1](#) [A7BS-207-S](#) [A7BS-207-S05-1](#) [A7BS-219](#) [A7BS-219-1](#)
[A7BS-254](#) [A7BS-255](#) [A7BS-255-1](#) [A7BS-256](#) [A7BS-S](#) [A7BL-206-S09-1](#) [A7BS-207-D](#) [A7BS-206-S13-1](#)

Компания «Океан Электроники» предлагает заключение долгосрочных отношений при поставках импортных электронных компонентов на взаимовыгодных условиях!

Наши преимущества:

- Поставка оригинальных импортных электронных компонентов напрямую с производств Америки, Европы и Азии, а так же с крупнейших складов мира;
- Широкая линейка поставок активных и пассивных импортных электронных компонентов (более 30 млн. наименований);
- Поставка сложных, дефицитных, либо снятых с производства позиций;
- Оперативные сроки поставки под заказ (от 5 рабочих дней);
- Экспресс доставка в любую точку России;
- Помощь Конструкторского Отдела и консультации квалифицированных инженеров;
- Техническая поддержка проекта, помощь в подборе аналогов, поставка прототипов;
- Поставка электронных компонентов под контролем ВП;
- Система менеджмента качества сертифицирована по Международному стандарту ISO 9001;
- При необходимости вся продукция военного и аэрокосмического назначения проходит испытания и сертификацию в лаборатории (по согласованию с заказчиком);
- Поставка специализированных компонентов военного и аэрокосмического уровня качества (Xilinx, Altera, Analog Devices, Intersil, Interpoint, Microsemi, Actel, Aeroflex, Peregrine, VPT, Syfer, Eurofarad, Texas Instruments, MS Kennedy, Miteq, Cobham, E2V, MA-COM, Hittite, Mini-Circuits, General Dynamics и др.);

Компания «Океан Электроники» является официальным дистрибьютором и эксклюзивным представителем в России одного из крупнейших производителей разъемов военного и аэрокосмического назначения «JONHON», а так же официальным дистрибьютором и эксклюзивным представителем в России производителя высокотехнологичных и надежных решений для передачи СВЧ сигналов «FORSTAR».



JONHON

«JONHON» (основан в 1970 г.)

Разъемы специального, военного и аэрокосмического назначения:

(Применяются в военной, авиационной, аэрокосмической, морской, железнодорожной, горно- и нефтедобывающей отраслях промышленности)

«FORSTAR» (основан в 1998 г.)

ВЧ соединители, коаксиальные кабели, кабельные сборки и микроволновые компоненты:

(Применяются в телекоммуникациях гражданского и специального назначения, в средствах связи, РЛС, а так же военной, авиационной и аэрокосмической отраслях промышленности).



Телефон: 8 (812) 309-75-97 (многоканальный)

Факс: 8 (812) 320-03-32

Электронная почта: ocean@oceanchips.ru

Web: <http://oceanchips.ru/>

Адрес: 198099, г. Санкт-Петербург, ул. Калинина, д. 2, корп. 4, лит. А