

7SB385

Bus Switch

The 7SB385 Bus Switch is an advanced high-speed line switch in ultra-small footprint.

Features

- High Speed: $t_{PD} = 0.25 \text{ ns (Max) @ } V_{CC} = 4.5 \text{ V}$
- 3Ω Switch Connection Between 2 Ports
- Power Down Protection Provided on Inputs
- Ultra-Small Packages
- These are Pb-Free Devices

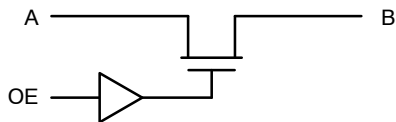

Figure 1. Logic Diagram

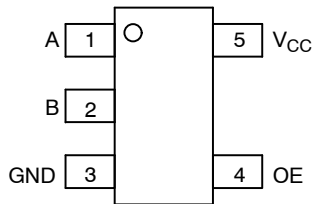

Figure 2. TSOP-5/SC-88A (Top View)

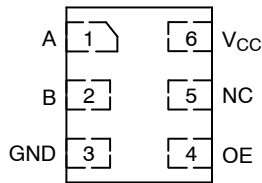

Figure 3. ULLGA6/UDFN6 (Top View)

Function Table

| Input OE | Function |
|----------|------------|
| L | Disconnect |
| H | B = A |



ON Semiconductor®

<http://onsemi.com>

MARKING DIAGRAMS

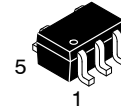

SOT-353/SC70-5/SC-88A
DF SUFFIX
CASE 419A

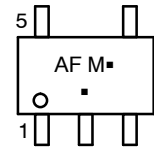

SOT23-5/TSOP-5/SC59-5
DT SUFFIX
CASE 483

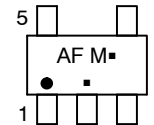

ULLGA6
1.0 x 1.0
CASE 613AD

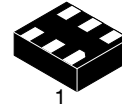

ULLGA6
1.2 x 1.0
CASE 613AE

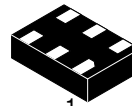

ULLGA6
1.45 x 1.0
CASE 613AF

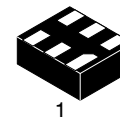

UDFN6
1.2 x 1.0
CASE 517AA



AF, 4, V, J, F = Specific Device Code
M = Date Code
▪ = Pb-Free Package

(Note: Microdot may be in either location)

ORDERING INFORMATION

See detailed ordering and shipping information in the package dimensions section on page 4 of this data sheet.

Table 1. MAXIMUM RATINGS

| Symbol | Parameter | Value | Unit |
|---------------|---|---|------------------------------------|
| V_{CC} | DC Supply Voltage | -0.5 to +7.0 | V |
| V_{IN} | Control Pin Input Voltage | -0.5 to +7.0 | V |
| $V_{I/O}$ | Switch Input / Output Voltage | -0.5 to +7.0 | V |
| I_{IK} | Control Pin DC Input Diode Current $V_{IN} < GND$ | -50 | mA |
| I_{OK} | Switch I/O Port DC Diode Current $V_{I/O} < GND$ | -50 | mA |
| I_O | On-State Switch Current | ± 128 | mA |
| | Continuous Current Through V_{CC} or GND | ± 150 | mA |
| I_{CC} | DC Supply Current per Supply Pin | ± 150 | mA |
| I_{GND} | DC Ground Current per Ground Pin | ± 150 | mA |
| T_{STG} | Storage Temperature Range | -65 to +150 | $^{\circ}C$ |
| T_L | Lead Temperature, 1 mm from Case for 10 Seconds | 260 | $^{\circ}C$ |
| T_J | Junction Temperature Under Bias | 150 | $^{\circ}C$ |
| θ_{JA} | Thermal Resistance | SC70-5/SC-88A (Note 1) TSOP-5 ULLGA6/UDFN6 | 350 230 496 $^{\circ}C/W$ |
| P_D | Power Dissipation in Still Air at 85 $^{\circ}C$ | SC70-5/SC-88A (Note 1) TSOP-5 ULLGA6/UDFN6 | 150 200 252 mW |
| MSL | Moisture Sensitivity | Level 1 | |
| F_R | Flammability Rating | Oxygen Index: 28 to 34 | UL 94 V-0 @ 0.125 in |
| V_{ESD} | ESD Withstand Voltage | Human Body Mode (Note 2) Machine Mode (Note 3) Charged Device Mode (Note 4) | >2000 >200 N/A V |
| $I_{LATCHUP}$ | Latchup Performance Above V_{CC} and Below GND at 85 $^{\circ}C$ (Note 5) | ± 100 | mA |

Stresses exceeding Maximum Ratings may damage the device. Maximum Ratings are stress ratings only. Functional operation above the Recommended Operating Conditions is not implied. Extended exposure to stresses above the Recommended Operating Conditions may affect device reliability.

1. Measured with minimum pad spacing on an FR4 board, using 10 mm-by-1 inch, 2 ounce copper trace no air flow.
2. Tested to EIA/ JESD22-A114-A
3. Tested to EIA/ JESD22-A115-A
4. Tested to JESD22-C101-A
5. Tested to EIA / JESD78.

Table 2. RECOMMENDED OPERATING CONDITIONS

| Symbol | Parameter | Min | Max | Unit |
|-----------------------|------------------------------------|---------------|---------|-------------|
| V_{CC} | Positive DC Supply Voltage | 4.0 | 5.5 | V |
| V_I | Control Pin Input Voltage | 0 | 5.5 | V |
| $V_{I/O}$ | Switch Input / Output Voltage | 0 | 5.5 | V |
| T_A | Operating Free-Air Temperature | -55 | +125 | $^{\circ}C$ |
| $\Delta t / \Delta V$ | Input Transition Rise or Fall Rate | 0 0 | 5 DC | nS/V |
| | | Control Input | | |
| | | Switch I/O | | |

Table 3. DC ELECTRICAL CHARACTERISTICS

| Symbol | Parameter | Conditions | V _{CC} (V) | T _A = 25°C | | | T _A = -55°C to +125°C | | Unit |
|------------------|--|---|---------------------|-----------------------|--------|--------|----------------------------------|--------|------|
| | | | | Min | Typ | Max | Min | Max | |
| V _{IK} | Clamp Diode Voltage | I _{IN} = -18 mA | 4.5 | | | -1.2 | | -1.2 | V |
| V _{IH} | High-Level Input Voltage (Control) | | 4.0 to 5.5 | 2.0 | | | 2.0 | | V |
| V _{IL} | Low-Level Input Voltage (Control) | | 4.0 to 5.5 | | | 0.8 | | 0.8 | V |
| I _{IN} | Input Leakage Current | 0 ≤ V _{IN} ≤ 5.5 V | 5.5 | | | ±0.1 | | ±1.0 | μA |
| I _{OFF} | Power Off Leakage Current | V _{I/O} = 0 to 5.5 V | 0 | | | ±0.1 | | ±1.0 | μA |
| I _{CC} | Quiescent Supply Current | I _O = 0, V _{IN} = V _{CC} or 0 V | 5.5 | | | ±0.1 | | ±1.0 | μA |
| ΔI _{CC} | Increase in Supply Current (Control Pin) | One input at 3.4 V; Other inputs at V _{CC} or GND | 5.5 | | | | | 2.5 | mA |
| R _{ON} | Switch ON Resistance | V _{I/O} = 0, I _{I/O} = 64 mA I _{I/O} = 30 mA | 4.5 | | 3 3 | 7 7 | | 7 7 | Ω |
| | | V _{I/O} = 2.4, I _{I/O} = 15 mA | 4.5 | | 6 | 15 | | 15 | |
| | | V _{I/O} = 2.4, I _{I/O} = 15 mA | 4.0 | | 10 | 20 | | 20 | |

Table 4. AC ELECTRICAL CHARACTERISTICS

| Symbol | Parameter | V _{CC} (V) | Test Condition | T _A = 25°C | | | T _A = -55°C to +125°C | | Unit |
|----------------------|-------------------------------------|---------------------|----------------------------|-----------------------|------|------|----------------------------------|------|------|
| | | | | Min | Typ | Max | Min | Max | |
| t _{PD} | Propagation Delay, A to B or B to A | 4.0 to 5.5 | See Figure 3 | | | 0.25 | | 0.25 | ns |
| | | | | | 0.25 | | 0.25 | | |
| t _{EN} | Output Enable Time | 4.5 to 5.5 | | 0.8 | 2.5 | 4.2 | 0.8 | 4.2 | ns |
| | | 4.0 | | 0.8 | 3.0 | 4.6 | 0.8 | 4.6 | |
| t _{DIS} | Output Disable Time | 4.5 to 5.5 | | 0.8 | 3.1 | 4.8 | 0.8 | 4.8 | ns |
| | | 4.0 | | 0.8 | 2.9 | 4.4 | 0.8 | 4.4 | |
| C _{IN} | Control Input Capacitance | 5.0 | V _{IN} = 3 V or 0 | | 2.0 | | | pF | |
| C _{IO(ON)} | Switch On Capacitance | 5.0 | Switch ON | | 10 | | | pF | |
| C _{IO(OFF)} | Switch Off Capacitance | 5.0 | Switch OFF | | 3.5 | | | pF | |

AC Loading and Waveforms



LOAD CIRCUIT

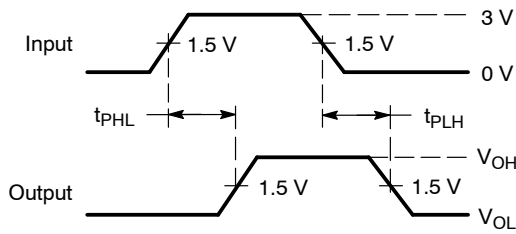

VOLTAGE WAVEFORMS PROPAGATION DELAY TIMES

| TEST | S1 |
|-------------------|------|
| t_{PD} | Open |
| t_{PLZ}/t_{PZL} | 7 V |
| t_{PHZ}/t_{PZH} | GND |

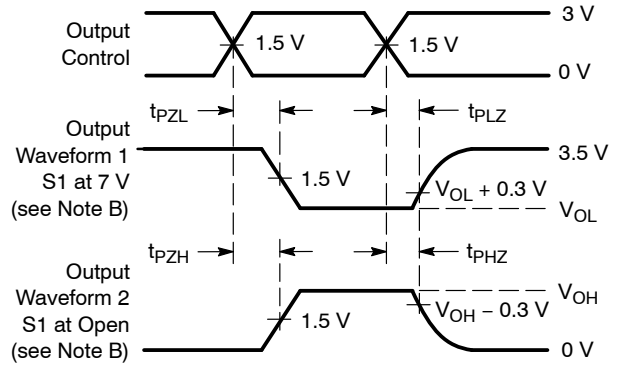

VOLTAGE WAVEFORMS ENABLE AND DISABLE TIMES

- A. C_L includes probe and jig capacitance.
- B. Waveform 1 is for an output with internal conditions such that the output is low, except when disabled by the output control. Waveform 2 is for an output with internal conditions such that the output is high, except when disabled by the output control.
- C. All input pulses are supplied by generators having the following characteristics: PRR \leq 10 MHz, $Z_O = 50 \Omega$, $t_r \leq 2.5$ ns, $t_f \leq 2.5$ ns.
- D. The output is measured with one input transition per measurement.
- E. t_{PLZ} and t_{PHZ} are the same as t_{dis} .
- F. t_{PZL} and t_{PZH} are the same as t_{en} .
- G. t_{PLH} and t_{PHL} are the same as t_{pd} .

Figure 4. Load Circuit and Voltage Waveforms

DEVICE ORDERING INFORMATION

| Device | Package | Shipping [†] |
|---------------|-------------------------------------|-----------------------|
| 7SB385DTT1G | TSOP-5 (Pb-Free) | 3000 / Tape & Reel |
| 7SB385DFT2G | SC-88A (Pb-Free) | 3000 / Tape & Reel |
| 7SB385AMX1TCG | ULLGA6 - 0.5 mm Pitch (Pb-Free) | 3000 / Tape & Reel |
| 7SB385BMX1TCG | ULLGA6 - 0.4 mm Pitch (Pb-Free) | 3000 / Tape & Reel |
| 7SB385CMX1TCG | ULLGA6 - 0.35 mm Pitch (Pb-Free) | 3000 / Tape & Reel |
| 7SB385MUTCG | UDFN6 - 0.4 mm Pitch (Pb-Free) | 3000 / Tape & Reel |

[†]For information on tape and reel specifications, including part orientation and tape sizes, please refer to our Tape and Reel Packaging Specifications Brochure, BRD8011/D.

7SB385

PACKAGE DIMENSIONS

SC-88A, SOT-353, SC-70
CASE 419A-02
ISSUE J

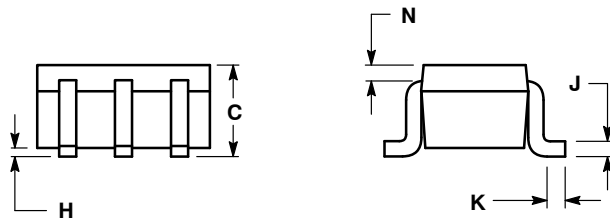
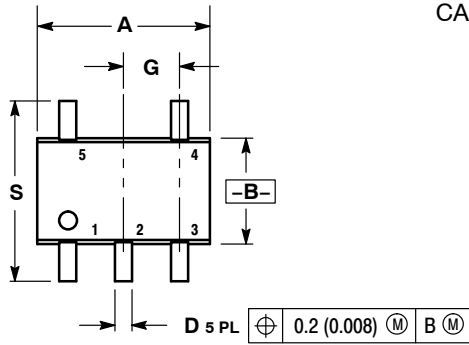

NOTES:

1. DIMENSIONING AND TOLERANCING PER ANSI Y14.5M, 1982.
2. CONTROLLING DIMENSION: INCH.
3. 419A-01 OBSOLETE. NEW STANDARD 419A-02.
4. DIMENSIONS A AND B DO NOT INCLUDE MOLD FLASH, PROTRUSIONS, OR GATE BURRS.

| DIM | INCHES | | MILLIMETERS | |
|-----|-----------|-------|-------------|------|
| | MIN | MAX | MIN | MAX |
| A | 0.071 | 0.087 | 1.80 | 2.20 |
| B | 0.045 | 0.053 | 1.15 | 1.35 |
| C | 0.031 | 0.043 | 0.80 | 1.10 |
| D | 0.004 | 0.012 | 0.10 | 0.30 |
| G | 0.026 BSC | | 0.65 BSC | |
| H | --- | 0.004 | --- | 0.10 |
| J | 0.004 | 0.010 | 0.10 | 0.25 |
| K | 0.004 | 0.012 | 0.10 | 0.30 |
| N | 0.008 REF | | 0.20 REF | |
| S | 0.079 | 0.087 | 2.00 | 2.20 |

7SB385

PACKAGE DIMENSIONS

TSOP-5 CASE 483-02 ISSUE H



NOTES:

1. DIMENSIONING AND TOLERANCING PER ASME Y14.5M, 1994.
2. CONTROLLING DIMENSION: MILLIMETERS.
3. MAXIMUM LEAD THICKNESS INCLUDES LEAD FINISH THICKNESS. MINIMUM LEAD THICKNESS IS THE MINIMUM THICKNESS OF BASE MATERIAL.
4. DIMENSIONS A AND B DO NOT INCLUDE MOLD FLASH, PROTRUSIONS, OR GATE BURRS.
5. OPTIONAL CONSTRUCTION: AN ADDITIONAL TRIMMED LEAD IS ALLOWED IN THIS LOCATION. TRIMMED LEAD NOT TO EXTEND MORE THAN 0.2 FROM BODY.

| MILLIMETERS | | |
|-------------|------|------|
| DIM | MIN | MAX |
| A | 3.00 | BSC |
| B | 1.50 | BSC |
| C | 0.90 | 1.10 |
| D | 0.25 | 0.50 |
| G | 0.95 | BSC |
| H | 0.01 | 0.10 |
| J | 0.10 | 0.26 |
| K | 0.20 | 0.60 |
| L | 1.25 | 1.55 |
| M | 0° | 10° |
| S | 2.50 | 3.00 |

SOLDERING FOOTPRINT*

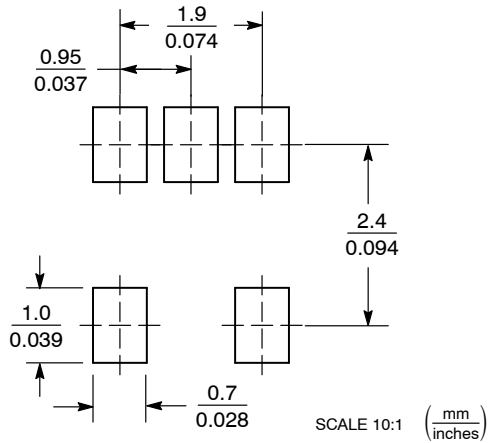

*For additional information on our Pb-Free strategy and soldering details, please download the ON Semiconductor Soldering and Mounting Techniques Reference Manual, SOLDERRM/D.

7SB385

PACKAGE DIMENSIONS

UDFN6 1.2x1.0, 0.4P
CASE 517AA-01
ISSUE C

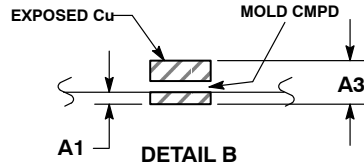
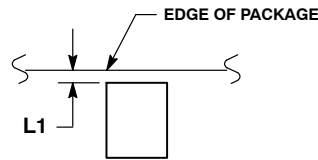

NOTES:

1. DIMENSIONING AND TOLERANCING PER ASME Y14.5M, 1994.
2. CONTROLLING DIMENSION: MILLIMETERS.
3. DIMENSION b APPLIES TO PLATED TERMINAL AND IS MEASURED BETWEEN 0.25 AND 0.30 mm FROM TERMINAL.
4. COPLANARITY APPLIES TO THE EXPOSED PAD AS WELL AS THE TERMINALS.

| MILLIMETERS | | |
|-------------|----------|------|
| DIM | MIN | MAX |
| A | 0.45 | 0.55 |
| A1 | 0.00 | 0.05 |
| A3 | 0.127 | REF |
| b | 0.15 | 0.25 |
| D | 1.20 BSC | |
| E | 1.00 BSC | |
| e | 0.40 BSC | |
| L | 0.30 | 0.40 |
| L1 | 0.00 | 0.15 |
| L2 | 0.40 | 0.50 |

MOUNTING FOOTPRINT*

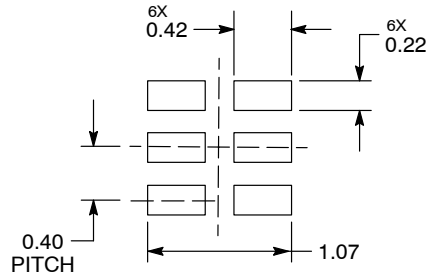

DIMENSIONS: MILLIMETERS

*For additional information on our Pb-Free strategy and soldering details, please download the ON Semiconductor Soldering and Mounting Techniques Reference Manual, SOLDERRM/D.

7SB385

PACKAGE DIMENSIONS

ULLGA6 1.0x1.0, 0.35P CASE 613AD-01 ISSUE A



NOTES:

1. DIMENSIONING AND TOLERANCING PER ASME Y14.5M, 1994.
2. CONTROLLING DIMENSION: MILLIMETERS.
3. DIMENSION b APPLIES TO PLATED TERMINAL AND IS MEASURED BETWEEN 0.15 AND 0.30 mm FROM THE TERMINAL TIP.
4. A MAXIMUM OF 0.05 PULL BACK OF THE PLATED TERMINAL FROM THE EDGE OF THE PACKAGE IS ALLOWED.

| MILLIMETERS | | |
|-------------|----------|------|
| DIM | MIN | MAX |
| A | --- | 0.40 |
| A1 | 0.00 | 0.05 |
| b | 0.12 | 0.22 |
| D | 1.00 BSC | |
| E | 1.00 BSC | |
| e | 0.35 BSC | |
| L | 0.25 | 0.35 |
| L1 | 0.30 | 0.40 |

MOUNTING FOOTPRINT SOLDERMASK DEFINED*

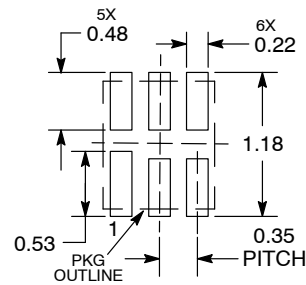

DIMENSIONS: MILLIMETERS

*For additional information on our Pb-Free strategy and soldering details, please download the ON Semiconductor Soldering and Mounting Techniques Reference Manual, SOLDERRM/D.

7SB385

PACKAGE DIMENSIONS

ULLGA6 1.2x1.0, 0.4P
CASE 613AE-01
ISSUE A



NOTES:

1. DIMENSIONING AND TOLERANCING PER ASME Y14.5M, 1994.
2. CONTROLLING DIMENSION: MILLIMETERS.
3. DIMENSION b APPLIES TO PLATED TERMINAL AND IS MEASURED BETWEEN 0.15 AND 0.30 mm FROM THE TERMINAL TIP.
4. A MAXIMUM OF 0.05 PULL BACK OF THE PLATED TERMINAL FROM THE EDGE OF THE PACKAGE IS ALLOWED.

| MILLIMETERS | | |
|-------------|----------|------|
| DIM | MIN | MAX |
| A | --- | 0.40 |
| A1 | 0.00 | 0.05 |
| b | 0.15 | 0.25 |
| D | 1.20 BSC | |
| E | 1.00 BSC | |
| e | 0.40 BSC | |
| L | 0.25 | 0.35 |
| L1 | 0.35 | 0.45 |

**MOUNTING FOOTPRINT
SOLDERMASK DEFINED***



DIMENSIONS: MILLIMETERS

*For additional information on our Pb-Free strategy and soldering details, please download the ON Semiconductor Soldering and Mounting Techniques Reference Manual, SOLDERRM/D.

7SB385

PACKAGE DIMENSIONS

ULLGA6 1.45x1.0, 0.5P
CASE 613AF-01
ISSUE A

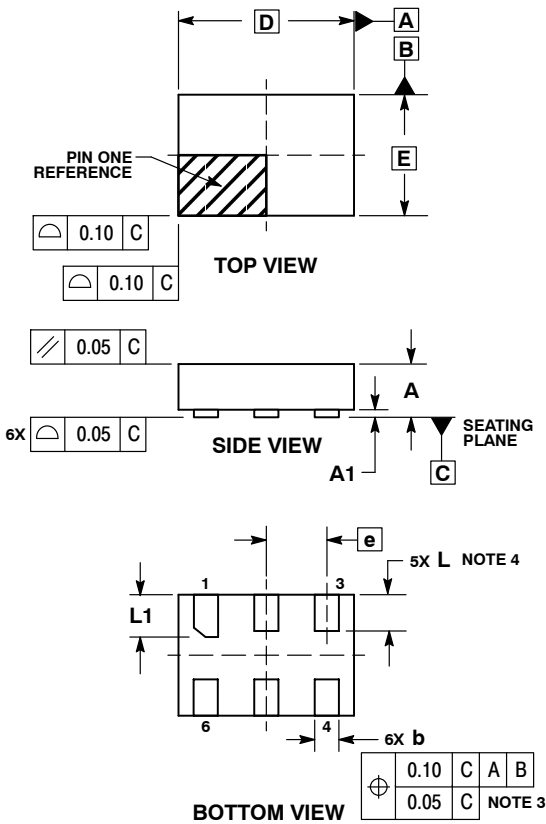

NOTES:

1. DIMENSIONING AND TOLERANCING PER ASME Y14.5M, 1994.
2. CONTROLLING DIMENSION: MILLIMETERS.
3. DIMENSION b APPLIES TO PLATED TERMINAL AND IS MEASURED BETWEEN 0.15 AND 0.30 mm FROM THE TERMINAL TIP.
4. A MAXIMUM OF 0.05 PULL BACK OF THE PLATED TERMINAL FROM THE EDGE OF THE PACKAGE IS ALLOWED.

| DIM | MILLIMETERS | |
|-----|-------------|------|
| | MIN | MAX |
| A | --- | 0.40 |
| A1 | 0.00 | 0.05 |
| b | 0.15 | 0.25 |
| D | 1.45 BSC | |
| E | 1.00 BSC | |
| e | 0.50 BSC | |
| L | 0.25 | 0.35 |
| L1 | 0.30 | 0.40 |

**MOUNTING FOOTPRINT
SOLDERMASK DEFINED***

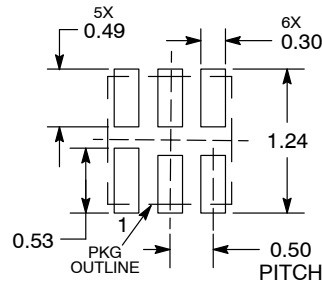

DIMENSIONS: MILLIMETERS

*For additional information on our Pb-Free strategy and soldering details, please download the ON Semiconductor Soldering and Mounting Techniques Reference Manual, SOLDERRM/D.

ON Semiconductor and are registered trademarks of Semiconductor Components Industries, LLC (SCILLC). SCILLC reserves the right to make changes without further notice to any products herein. SCILLC makes no warranty, representation or guarantee regarding the suitability of its products for any particular purpose, nor does SCILLC assume any liability arising out of the application or use of any product or circuit, and specifically disclaims any and all liability, including without limitation special, consequential or incidental damages. "Typical" parameters which may be provided in SCILLC data sheets and/or specifications can and do vary in different applications and actual performance may vary over time. All operating parameters, including "Typicals" must be validated for each customer application by customer's technical experts. SCILLC does not convey any license under its patent rights nor the rights of others. SCILLC products are not designed, intended, or authorized for use as components in systems intended for surgical implant into the body, or other applications intended to support or sustain life, or for any other application in which the failure of the SCILLC product could create a situation where personal injury or death may occur. Should Buyer purchase or use SCILLC products for any such unintended or unauthorized application, Buyer shall indemnify and hold SCILLC and its officers, employees, subsidiaries, affiliates, and distributors harmless against all claims, costs, damages, and expenses, and reasonable attorney fees arising out of, directly or indirectly, any claim of personal injury or death associated with such unintended or unauthorized use, even if such claim alleges that SCILLC was negligent regarding the design or manufacture of the part. SCILLC is an Equal Opportunity/Affirmative Action Employer. This literature is subject to all applicable copyright laws and is not for resale in any manner.

PUBLICATION ORDERING INFORMATION

LITERATURE FULFILLMENT:
Literature Distribution Center for ON Semiconductor
P.O. Box 5163, Denver, Colorado 80217 USA
Phone: 303-675-2175 or 800-344-3860 Toll Free USA/Canada
Fax: 303-675-2176 or 800-344-3867 Toll Free USA/Canada
Email: orderlit@onsemi.com

N. American Technical Support: 800-282-9855 Toll Free USA/Canada
Europe, Middle East and Africa Technical Support:
Phone: 421 33 790 2910
Japan Customer Focus Center
Phone: 81-3-5773-3850

ON Semiconductor Website: www.onsemi.com
Order Literature: <http://www.onsemi.com/orderlit>

For additional information, please contact your local Sales Representative

Компания «Океан Электроники» предлагает заключение долгосрочных отношений при поставках импортных электронных компонентов на взаимовыгодных условиях!

Наши преимущества:

- Поставка оригинальных импортных электронных компонентов напрямую с производств Америки, Европы и Азии, а так же с крупнейших складов мира;
- Широкая линейка поставок активных и пассивных импортных электронных компонентов (более 30 млн. наименований);
- Поставка сложных, дефицитных, либо снятых с производства позиций;
- Оперативные сроки поставки под заказ (от 5 рабочих дней);
- Экспресс доставка в любую точку России;
- Помощь Конструкторского Отдела и консультации квалифицированных инженеров;
- Техническая поддержка проекта, помощь в подборе аналогов, поставка прототипов;
- Поставка электронных компонентов под контролем ВП;
- Система менеджмента качества сертифицирована по Международному стандарту ISO 9001;
- При необходимости вся продукция военного и аэрокосмического назначения проходит испытания и сертификацию в лаборатории (по согласованию с заказчиком);
- Поставка специализированных компонентов военного и аэрокосмического уровня качества (Xilinx, Altera, Analog Devices, Intersil, Interpoint, Microsemi, Actel, Aeroflex, Peregrine, VPT, Syfer, Eurofarad, Texas Instruments, MS Kennedy, Miteq, Cobham, E2V, MA-COM, Hittite, Mini-Circuits, General Dynamics и др.);

Компания «Океан Электроники» является официальным дистрибьютором и эксклюзивным представителем в России одного из крупнейших производителей разъемов военного и аэрокосмического назначения «JONHON», а так же официальным дистрибьютором и эксклюзивным представителем в России производителя высокотехнологичных и надежных решений для передачи СВЧ сигналов «FORSTAR».



JONHON

«JONHON» (основан в 1970 г.)

Разъемы специального, военного и аэрокосмического назначения:

(Применяются в военной, авиационной, аэрокосмической, морской, железнодорожной, горно- и нефтедобывающей отраслях промышленности)

«FORSTAR» (основан в 1998 г.)

ВЧ соединители, коаксиальные кабели, кабельные сборки и микроволновые компоненты:

(Применяются в телекоммуникациях гражданского и специального назначения, в средствах связи, РЛС, а так же военной, авиационной и аэрокосмической отраслях промышленности).



Телефон: 8 (812) 309-75-97 (многоканальный)

Факс: 8 (812) 320-03-32

Электронная почта: ocean@oceanchips.ru

Web: <http://oceanchips.ru/>

Адрес: 198099, г. Санкт-Петербург, ул. Калинина, д. 2, корп. 4, лит. А