

# NSS40501UW3T2G

## 40 V, 5.0 A, Low $V_{CE(sat)}$ NPN Transistor

ON Semiconductor's e<sup>2</sup>PowerEdge family of low  $V_{CE(sat)}$  transistors are miniature surface mount devices featuring ultra low saturation voltage ( $V_{CE(sat)}$ ) and high current gain capability. These are designed for use in low voltage, high speed switching applications where affordable efficient energy control is important.

Typical applications are DC-DC converters and power management in portable and battery powered products such as cellular and cordless phones, PDAs, computers, printers, digital cameras and MP3 players. Other applications are low voltage motor controls in mass storage products such as disc drives and tape drives. In the automotive industry they can be used in air bag deployment and in the instrument cluster. The high current gain allows e<sup>2</sup>PowerEdge devices to be driven directly from PMU's control outputs, and the Linear Gain (Beta) makes them ideal components in analog amplifiers.

### Features

- This is a Pb-Free Device

### MAXIMUM RATINGS ( $T_A = 25^\circ\text{C}$ )

| Rating                         | Symbol    | Max                        | Unit |
|--------------------------------|-----------|----------------------------|------|
| Collector-Emitter Voltage      | $V_{CEO}$ | 40                         | Vdc  |
| Collector-Base Voltage         | $V_{CBO}$ | 40                         | Vdc  |
| Emitter-Base Voltage           | $V_{EBO}$ | 6.0                        | Vdc  |
| Collector Current - Continuous | $I_C$     | 5.0                        | Adc  |
| Collector Current - Peak       | $I_{CM}$  | 7.0                        | A    |
| Electrostatic Discharge        | ESD       | HBM Class 3B<br>MM Class C |      |

### THERMAL CHARACTERISTICS

| Characteristic  | Symbol                   | Max            | Unit                       |
|---|--------------------------|----------------|----------------------------|
| Total Device Dissipation, $T_A = 25^\circ\text{C}$<br>Derate above $25^\circ\text{C}$ | $P_D$ (Note 1)           | 875<br>7.0     | mW<br>mW/ $^\circ\text{C}$ |
| Thermal Resistance,<br>Junction-to-Ambient  | $R_{\theta JA}$ (Note 1) | 143            | $^\circ\text{C}/\text{W}$  |
| Total Device Dissipation, $T_A = 25^\circ\text{C}$<br>Derate above $25^\circ\text{C}$ | $P_D$ (Note 2)           | 1.5<br>11.8    | W<br>mW/ $^\circ\text{C}$  |
| Thermal Resistance,<br>Junction-to-Ambient  | $R_{\theta JA}$ (Note 2) | 85             | $^\circ\text{C}/\text{W}$  |
| Thermal Resistance,<br>Junction-to-Lead #3  | $R_{\theta JL}$ (Note 2) | 23             | $^\circ\text{C}/\text{W}$  |
| Junction and Storage<br>Temperature Range   | $T_J, T_{stg}$           | -55 to<br>+150 | $^\circ\text{C}$           |

Stresses exceeding Maximum Ratings may damage the device. Maximum Ratings are stress ratings only. Functional operation above the Recommended Operating Conditions is not implied. Extended exposure to stresses above the Recommended Operating Conditions may affect device reliability.

1. FR-4 @ 100 mm<sup>2</sup>, 1 oz copper traces.
2. FR-4 @ 500 mm<sup>2</sup>, 1 oz copper traces.



ON Semiconductor®

<http://onsemi.com>

## 40 VOLTS, 5.0 AMPS NPN LOW $V_{CE(sat)}$ TRANSISTOR EQUIVALENT $R_{DS(on)}$ 38 m $\Omega$

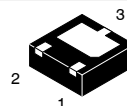
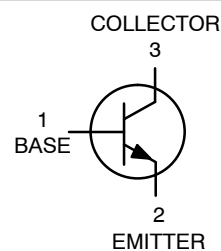

WDFN3  
CASE 506AU

### MARKING DIAGRAM

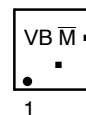

VB = Specific Device Code

M = Date Code

▪ = Pb-Free Package

(Note: Microdot may be in either location)

### ORDERING INFORMATION

| Device         | Package            | Shipping†            |
|----------------|--------------------|----------------------|
| NSS40501UW3T2G | WDFN3<br>(Pb-Free) | 3000/<br>Tape & Reel |

†For information on tape and reel specifications, including part orientation and tape sizes, please refer to our Tape and Reel Packaging Specifications Brochure, BRD8011/D.

# NSS40501UW3T2G

## ELECTRICAL CHARACTERISTICS (T<sub>A</sub> = 25°C unless otherwise noted)

| Characteristic  | Symbol               | Min | Typical | Max | Unit |
|---|----------------------|-----|---------|-----|------|
| <b>OFF CHARACTERISTICS</b>  |                      |     |         |     |      |
| Collector – Emitter Breakdown Voltage<br>(I <sub>C</sub> = 10 mA, I <sub>B</sub> = 0) | V <sub>(BR)CEO</sub> | 40  | –       | –   | Vdc  |
| Collector – Base Breakdown Voltage<br>(I <sub>C</sub> = 0.1 mA, I <sub>E</sub> = 0)   | V <sub>(BR)CBO</sub> | 40  | –       | –   | Vdc  |
| Emitter – Base Breakdown Voltage<br>(I <sub>E</sub> = 0.1 mA, I <sub>C</sub> = 0)     | V <sub>(BR)EBO</sub> | 6.0 | –       | –   | Vdc  |
| Collector Cutoff Current<br>(V <sub>CB</sub> = 40 Vdc, I <sub>E</sub> = 0)            | I <sub>CBO</sub>     | –   | –       | 0.1 | μAdc |
| Emitter Cutoff Current<br>(V <sub>EB</sub> = 6.0 Vdc)                                 | I <sub>EBO</sub>     | –   | –       | 0.1 | μAdc |

## ON CHARACTERISTICS

|   |                      |                                 |  |  |     |
|---|----------------------|---------------------------------|--|--|-----|
| DC Current Gain (Note 3)<br>(I <sub>C</sub> = 10 mA, V <sub>CE</sub> = 2.0 V)<br>(I <sub>C</sub> = 500 mA, V <sub>CE</sub> = 2.0 V)<br>(I <sub>C</sub> = 1.0 A, V <sub>CE</sub> = 2.0 V)<br>(I <sub>C</sub> = 2.0 A, V <sub>CE</sub> = 2.0 V)<br>(I <sub>C</sub> = 3.0 A, V <sub>CE</sub> = 2.0 V)  | h <sub>FE</sub>      | 200<br>200<br>200<br>200<br>180 | –<br>–<br>320<br>305<br>295                        | –<br>–<br>–<br>–<br>–                              |     |
| Collector – Emitter Saturation Voltage (Note 3)<br>(I <sub>C</sub> = 0.1 A, I <sub>B</sub> = 0.010 A)<br>(I <sub>C</sub> = 1.0 A, I <sub>B</sub> = 0.100 A)<br>(I <sub>C</sub> = 1.0 A, I <sub>B</sub> = 0.010 A)<br>(I <sub>C</sub> = 2.0 A, I <sub>B</sub> = 0.020 A)<br>(I <sub>C</sub> = 3.0 A, I <sub>B</sub> = 0.030 A)<br>(I <sub>C</sub> = 4.0 A, I <sub>B</sub> = 0.400 A) | V <sub>CE(sat)</sub> | –<br>–<br>–<br>–<br>–<br>–      | 0.006<br>0.038<br>0.060<br>0.097<br>0.130<br>0.110 | 0.010<br>0.045<br>0.080<br>0.120<br>0.160<br>0.150 | V   |
| Base – Emitter Saturation Voltage (Note 3)<br>(I <sub>C</sub> = 1.0 A, I <sub>B</sub> = 0.01 A)   | V <sub>BE(sat)</sub> | –                               | 0.760  | 0.900  | V   |
| Base – Emitter Turn-on Voltage (Note 3)<br>(I <sub>C</sub> = 2.0 A, V <sub>CE</sub> = 2.0 V)  | V <sub>BE(on)</sub>  | –                               | 0.730  | 0.900  | V   |
| Cutoff Frequency<br>(I <sub>C</sub> = 100 mA, V <sub>CE</sub> = 5.0 V, f = 100 MHz)   | f <sub>T</sub>       | 150                             | –  | –  | MHz |
| Input Capacitance (V <sub>EB</sub> = 0.5 V, f = 1.0 MHz)  | C <sub>ibo</sub>     | –                               |  | 650  | pF  |
| Output Capacitance (V <sub>CB</sub> = 3.0 V, f = 1.0 MHz)   | C <sub>obo</sub>     | –                               |  | 70   | pF  |

## SWITCHING CHARACTERISTICS

|  |                |   |   |      |    |
|--|----------------|---|---|------|----|
| Delay (V <sub>CC</sub> = 30 V, I <sub>C</sub> = 750 mA, I <sub>B1</sub> = 15 mA)   | t <sub>d</sub> | – | – | 90   | ns |
| Rise (V <sub>CC</sub> = 30 V, I <sub>C</sub> = 750 mA, I <sub>B1</sub> = 15 mA)    | t <sub>r</sub> | – | – | 100  | ns |
| Storage (V <sub>CC</sub> = 30 V, I <sub>C</sub> = 750 mA, I <sub>B1</sub> = 15 mA) | t <sub>s</sub> | – | – | 1050 | ns |
| Fall (V <sub>CC</sub> = 30 V, I <sub>C</sub> = 750 mA, I <sub>B1</sub> = 15 mA)    | t <sub>f</sub> | – | – | 100  | ns |

3. Pulsed Condition: Pulse Width = 300 μsec, Duty Cycle ≤ 2%.

# NSS40501UW3T2G

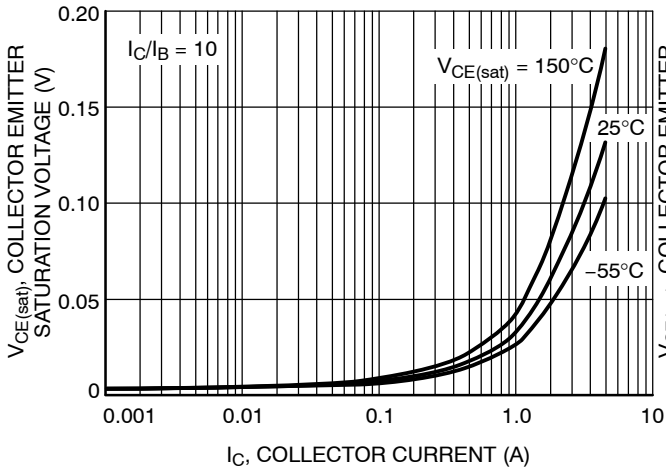

**Figure 1. Collector Emitter Saturation Voltage vs. Collector Current**

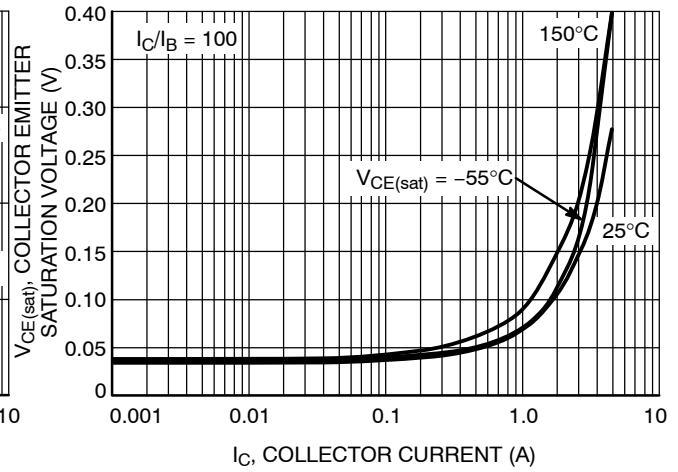

**Figure 2. Collector Emitter Saturation Voltage vs. Collector Current**

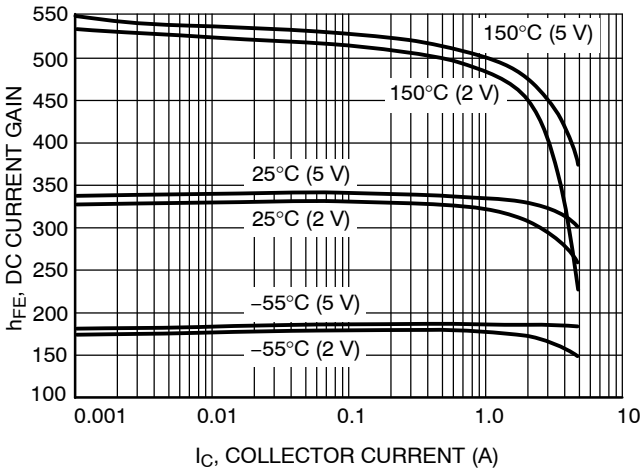

**Figure 3. DC Current Gain vs. Collector Current**

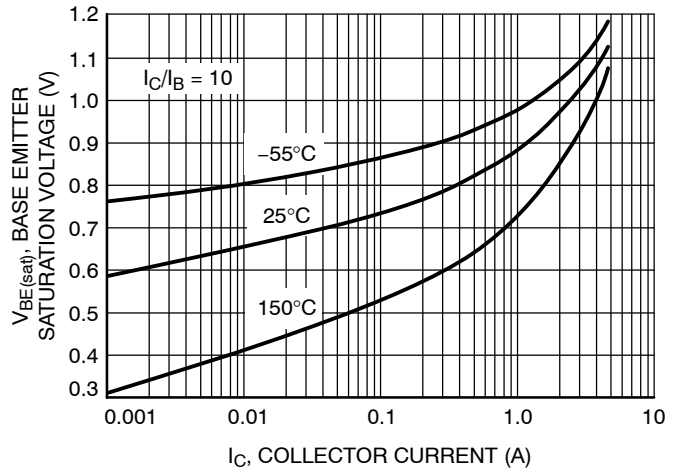

**Figure 4. Base Emitter Saturation Voltage vs. Collector Current**

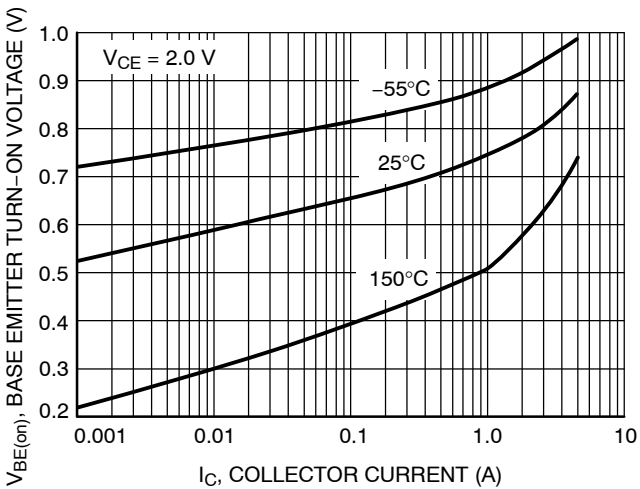

**Figure 5. Base Emitter Turn-On Voltage vs. Collector Current**

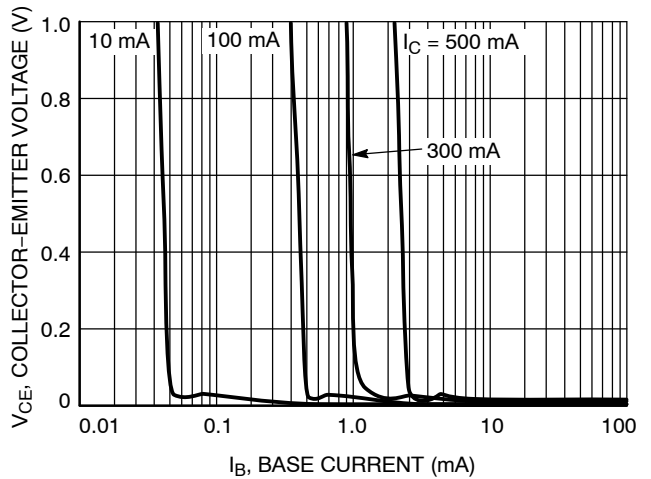

**Figure 6. Saturation Region**

# NSS40501UW3T2G

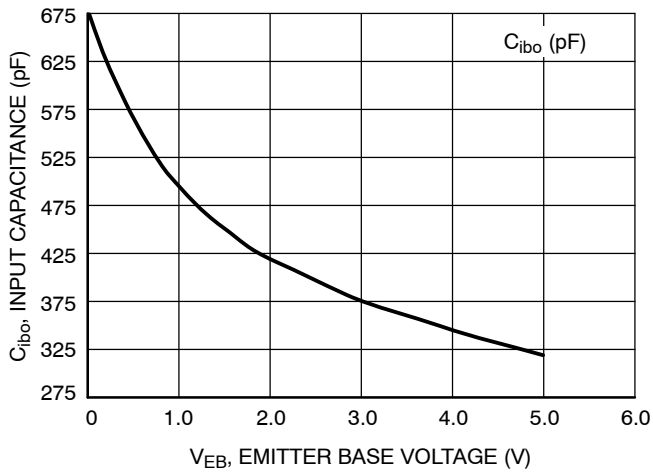

Figure 7. Input Capacitance

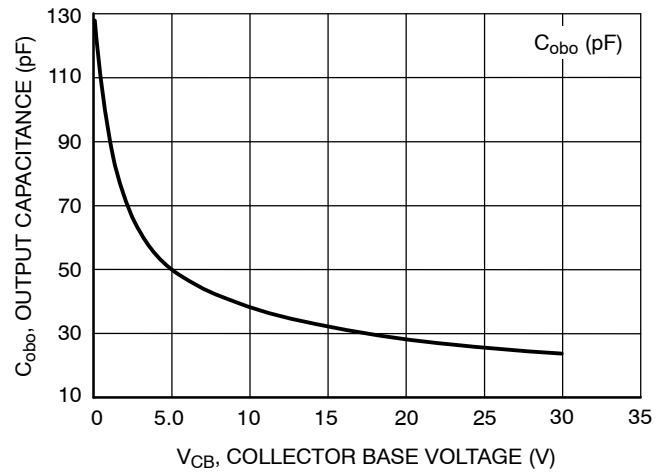

Figure 8. Output Capacitance

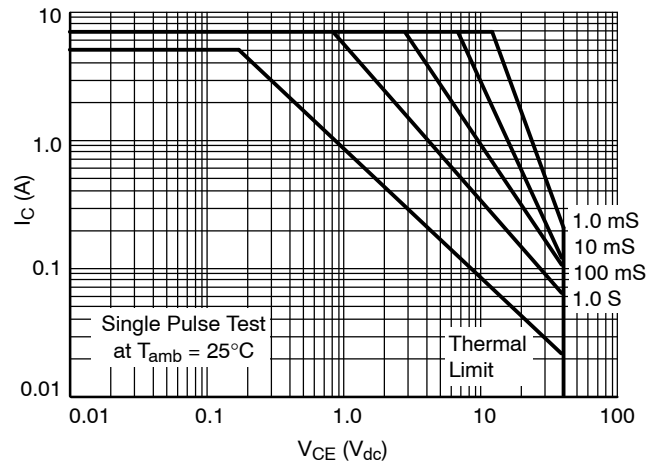
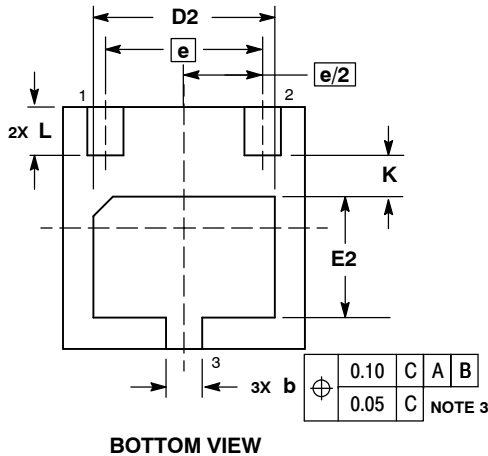
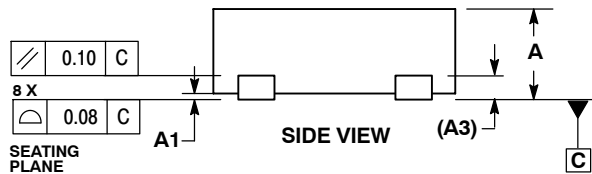
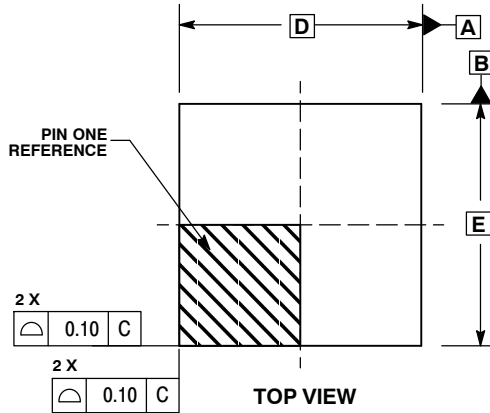

Figure 9. Safe Operating Area

# NSS40501UW3T2G

## PACKAGE DIMENSIONS

WDFN3  
CASE 506AU  
ISSUE O



NOTES:

1. DIMENSIONING AND TOLERANCING PER ASME Y14.5M, 1994 .
2. CONTROLLING DIMENSION: MILLIMETERS.
3. DIMENSION b APPLIES TO PLATED TERMINAL AND IS MEASURED BETWEEN 0.25 AND 0.30 MM FROM TERMINAL.
4. COPLANARITY APPLIES TO THE EXPOSED PAD AS WELL AS THE TERMINALS.

| DIM | MILLIMETERS |          |      | INCHES |           |       |
|-----|-------------|----------|------|--------|-----------|-------|
|     | MIN         | NOM      | MAX  | MIN    | NOM       | MAX   |
| A   | 0.70        | 0.75     | 0.80 | 0.028  | 0.030     | 0.031 |
| A1  | 0.00        |          | 0.05 | 0.000  |           | 0.002 |
| A3  |             | 0.20 REF |      |        | 0.008 REF |       |
| b   | 0.25        | 0.30     | 0.35 | 0.010  | 0.012     | 0.014 |
| D   |             | 2.00 BSC |      |        | 0.079 BSC |       |
| D2  | 1.40        | 1.50     | 1.60 | 0.055  | 0.059     | 0.063 |
| E   |             | 2.00 BSC |      |        | 0.079 BSC |       |
| E2  | 0.90        | 1.00     | 1.10 | 0.035  | 0.039     | 0.043 |
| e   |             | 1.30 BSC |      |        | 0.051 BSC |       |
| K   |             | 0.35 REF |      |        | 0.014 REF |       |
| L   | 0.35        | 0.40     | 0.45 | 0.014  | 0.016     | 0.018 |

### SOLDERING FOOTPRINT\*

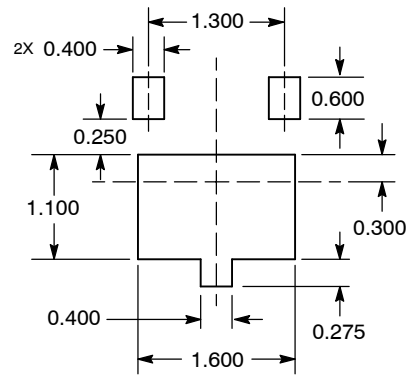

\*For additional information on our Pb-Free strategy and soldering details, please download the ON Semiconductor Soldering and Mounting Techniques Reference Manual, SOLDERRM/D.

ON Semiconductor and are registered trademarks of Semiconductor Components Industries, LLC (SCILLC). SCILLC owns the rights to a number of patents, trademarks, copyrights, trade secrets, and other intellectual property. A listing of SCILLC's product/patent coverage may be accessed at [www.onsemi.com/site/pdf/Patent-Marking.pdf](http://www.onsemi.com/site/pdf/Patent-Marking.pdf). SCILLC reserves the right to make changes without further notice to any products herein. SCILLC makes no warranty, representation or guarantee regarding the suitability of its products for any particular purpose, nor does SCILLC assume any liability arising out of the application or use of any product or circuit, and specifically disclaims any and all liability, including without limitation special, consequential or incidental damages. "Typical" parameters which may be provided in SCILLC data sheets and/or specifications can and do vary in different applications and actual performance may vary over time. All operating parameters, including "Typicals" must be validated for each customer application by customer's technical experts. SCILLC does not convey any license under its patent rights nor the rights of others. SCILLC products are not designed, intended, or authorized for use as components in systems intended for surgical implant into the body, or other applications intended to support or sustain life, or for any other application in which the failure of the SCILLC product could create a situation where personal injury or death may occur. Should Buyer purchase or use SCILLC products for any such unintended or unauthorized application, Buyer shall indemnify and hold SCILLC and its officers, employees, subsidiaries, affiliates, and distributors harmless against all claims, costs, damages, and expenses, and reasonable attorney fees arising out of, directly or indirectly, any claim of personal injury or death associated with such unintended or unauthorized use, even if such claim alleges that SCILLC was negligent regarding the design or manufacture of the part. SCILLC is an Equal Opportunity/Affirmative Action Employer. This literature is subject to all applicable copyright laws and is not for resale in any manner.

### PUBLICATION ORDERING INFORMATION

**LITERATURE FULFILLMENT:**  
Literature Distribution Center for ON Semiconductor  
P.O. Box 5163, Denver, Colorado 80217 USA  
Phone: 303-675-2175 or 800-344-3860 Toll Free USA/Canada  
Fax: 303-675-2176 or 800-344-3867 Toll Free USA/Canada  
Email: [orderlit@onsemi.com](mailto:orderlit@onsemi.com)

**N. American Technical Support:** 800-282-9855 Toll Free  
USA/Canada  
**Europe, Middle East and Africa Technical Support:**  
Phone: 421 33 790 2910  
**Japan Customer Focus Center**  
Phone: 81-3-5817-1050

**ON Semiconductor Website:** [www.onsemi.com](http://www.onsemi.com)  
**Order Literature:** <http://www.onsemi.com/orderlit>

For additional information, please contact your local Sales Representative

Компания «Океан Электроники» предлагает заключение долгосрочных отношений при поставках импортных электронных компонентов на взаимовыгодных условиях!

Наши преимущества:

- Поставка оригинальных импортных электронных компонентов напрямую с производств Америки, Европы и Азии, а так же с крупнейших складов мира;
- Широкая линейка поставок активных и пассивных импортных электронных компонентов (более 30 млн. наименований);
- Поставка сложных, дефицитных, либо снятых с производства позиций;
- Оперативные сроки поставки под заказ (от 5 рабочих дней);
- Экспресс доставка в любую точку России;
- Помощь Конструкторского Отдела и консультации квалифицированных инженеров;
- Техническая поддержка проекта, помощь в подборе аналогов, поставка прототипов;
- Поставка электронных компонентов под контролем ВП;
- Система менеджмента качества сертифицирована по Международному стандарту ISO 9001;
- При необходимости вся продукция военного и аэрокосмического назначения проходит испытания и сертификацию в лаборатории (по согласованию с заказчиком);
- Поставка специализированных компонентов военного и аэрокосмического уровня качества (Xilinx, Altera, Analog Devices, Intersil, Interpoint, Microsemi, Actel, Aeroflex, Peregrine, VPT, Syfer, Eurofarad, Texas Instruments, MS Kennedy, Miteq, Cobham, E2V, MA-COM, Hittite, Mini-Circuits, General Dynamics и др.);

Компания «Океан Электроники» является официальным дистрибьютором и эксклюзивным представителем в России одного из крупнейших производителей разъемов военного и аэрокосмического назначения «JONHON», а так же официальным дистрибьютором и эксклюзивным представителем в России производителя высокотехнологичных и надежных решений для передачи СВЧ сигналов «FORSTAR».



## JONHON

«JONHON» (основан в 1970 г.)

Разъемы специального, военного и аэрокосмического назначения:

(Применяются в военной, авиационной, аэрокосмической, морской, железнодорожной, горно- и нефтедобывающей отраслях промышленности)

«FORSTAR» (основан в 1998 г.)

ВЧ соединители, коаксиальные кабели, кабельные сборки и микроволновые компоненты:

(Применяются в телекоммуникациях гражданского и специального назначения, в средствах связи, РЛС, а так же военной, авиационной и аэрокосмической отраслях промышленности).



Телефон: 8 (812) 309-75-97 (многоканальный)

Факс: 8 (812) 320-03-32

Электронная почта: [ocean@oceanchips.ru](mailto:ocean@oceanchips.ru)

Web: <http://oceanchips.ru/>

Адрес: 198099, г. Санкт-Петербург, ул. Калинина, д. 2, корп. 4, лит. А