

Aluminum Capacitors Power Long Life Snap-In

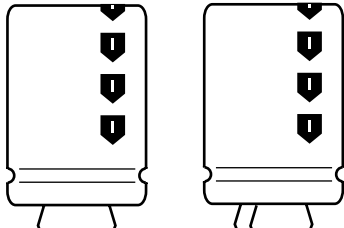
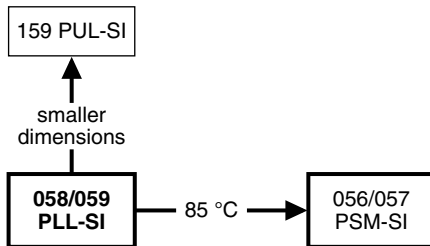


Fig.1 Component outlines



FEATURES

- Polarized aluminum electrolytic capacitors, non-solid electrolyte
- Large types, minimized dimensions, cylindrical aluminum case, insulated with a blue sleeve
- Very long useful life: up to 10 000 hours at 105 °C
- Extended temperature range: 105 °C
- Low ESR, high ripple current capability
- Keyed polarity version available


**RoHS
COMPLIANT**

APPLICATIONS

- Computer, telecommunication and industrial systems
- Smoothing and filtering applications
- Standard and switched mode power supplies
- Energy storage in pulse systems

MARKING

The capacitors are marked (where possible) with the following information:

- Rated capacitance (in μF)
- Tolerance code on rated capacitance, code letter in accordance with IEC 60062 (M for $\pm 20\%$)
- Rated voltage (in V)
- Date code (YYMM)
- Name of manufacturer
- Code for factory of origin
- ‘-’ sign to identify the negative terminal, visible from the top and side of the capacitor
- Code number
- Climatic category in accordance with IEC 60068

QUICK REFERENCE DATA

| DESCRIPTION | VALUE | |
|------------------------------------------------------|-----------------------------------------------------------|----------------|
| | 058 | 059 |
| Nominal case sizes ($\varnothing D \times L$ in mm) | 22 x 25 to 35 x 50 | |
| Rated capacitance range (E6 series), C_R | 33 to 47 000 μF | |
| Tolerance on C_R | $\pm 20\%$ | |
| Rated voltage range, U_R | 10 to 100 V | 200 to 400 V |
| Category temperature range | - 40 to + 105 °C | - 25 to 105 °C |
| Endurance test at 105 °C | ≤ 50 V: 2000 hours; ≥ 63 V: 5000 hours | |
| Useful life at 105 °C | ≤ 50 V: 5000 hours; ≥ 63 V: 10 000 hours | |
| Useful life at 40 °C, $1.9 \times I_R$ applied | ≤ 50 V: 125 000 hours; ≥ 63 V: 250 000 hours | |
| Shelf life at 0 V, 105 °C | 500 hours | |
| Based on sectional specification | IEC 60384-4/EN130300 | |
| Climatic category IEC 60068 | 40/105/56 | 25/105/56 |

SELECTION CHART FOR C_R , U_R AND RELEVANT NOMINAL CASE SIZES FOR 058 SERIES ($\varnothing D \times L$ in mm)

| C_R (μF) | U_R (V) | | | | | | |
|----------------------------|-----------|----|----|---------|---------|---------|---------|
| | 10 | 16 | 25 | 40 | 50 | 63 | 100 |
| 330 | - | - | - | - | - | - | 22 x 25 |
| 470 | - | - | - | - | - | - | 22 x 30 |
| 680 | - | - | - | - | - | 22 x 25 | 25 x 30 |
| | - | - | - | - | - | - | 22 x 40 |
| 1000 | - | - | - | - | 22 x 25 | 22 x 30 | 30 x 30 |
| | - | - | - | - | - | - | 25 x 40 |
| 1500 | - | - | - | 22 x 25 | 22 x 30 | 25 x 30 | 30 x 40 |
| | - | - | - | - | - | 22 x 40 | 25 x 50 |

| SELECTION CHART FOR C_R, U_R AND RELEVANT NOMINAL CASE SIZES FOR 058 SERIES (∅ D x L in mm) | | | | | | | |
|------------------------------------------------------------------------------------------------------------------------|--------------------|---------|---------|---------|---------|---------|---------|
| C _R (μF) | U _R (V) | | | | | | |
| | 10 | 16 | 25 | 40 | 50 | 63 | 100 |
| 2200 | - | - | 22 x 25 | 22 x 30 | 25 x 30 | 30 x 30 | 35 x 40 |
| | - | - | - | - | 22 x 40 | 25 x 40 | 30 x 50 |
| 3300 | - | 22 x 25 | 22 x 30 | 25 x 30 | 30 x 30 | 30 x 40 | 35 x 50 |
| | - | - | - | 22 x 40 | 25 x 40 | 25 x 50 | - |
| 4700 | 22 x 25 | 22 x 30 | 25 x 30 | 30 x 30 | 30 x 40 | 35 x 40 | - |
| | - | - | 22 x 40 | 25 x 40 | 25 x 50 | 30 x 50 | - |
| 6800 | 22 x 30 | 25 x 30 | 30 x 30 | 30 x 40 | 35 x 40 | 35 x 50 | - |
| | - | 22 x 40 | 25 x 40 | 25 x 50 | 30 x 50 | - | - |
| 10 000 | 25 x 30 | 30 x 30 | 30 x 40 | 35 x 40 | 35 x 50 | - | - |
| | 22 x 40 | 25 x 40 | 25 x 50 | 30 x 50 | - | - | - |
| 15 000 | 30 x 30 | 30 x 40 | 35 x 40 | 35 x 50 | - | - | - |
| | 25 x 40 | 25 x 50 | 30 x 50 | - | - | - | - |
| 22 000 | 30 x 40 | 35 x 40 | 35 x 50 | - | - | - | - |
| | 25 x 50 | 30 x 50 | - | - | - | - | - |
| 33 000 | 35 x 40 | 35 x 50 | - | - | - | - | - |
| | 30 x 50 | - | - | - | - | - | - |
| 47 000 | 35 x 50 | - | - | - | - | - | - |

| SELECTION CHART FOR C_R, U_R AND RELEVANT NOMINAL CASE SIZES FOR 059 SERIES (∅ D x L in mm) | | | | |
|------------------------------------------------------------------------------------------------------------------------|--------------------|---------|---------|---------|
| C _R (μF) | U _R (V) | | | |
| | 200 | 250 | 385 | 400 |
| 33 | - | - | 22 x 25 | - |
| 47 | - | - | 22 x 30 | 22 x 30 |
| 68 | - | 22 x 25 | 22 x 35 | 22 x 35 |
| | - | - | 25 x 30 | 25 x 30 |
| 100 | 22 x 25 | 22 x 30 | 30 x 30 | 30 x 30 |
| | - | - | 25 x 40 | 25 x 40 |
| 150 | 22 x 30 | 22 x 35 | 25 x 50 | 30 x 35 |
| | - | 25 x 30 | 30 x 40 | 25 x 50 |
| 220 | 22 x 35 | 30 x 30 | 35 x 40 | 35 x 40 |
| | 25 x 30 | 25 x 35 | 30 x 50 | 30 x 50 |
| 330 | 30 x 30 | 30 x 35 | 35 x 50 | 35 x 50 |
| | 25 x 40 | 25 x 50 | - | - |
| 470 | 30 x 35 | 35 x 35 | - | - |
| | 25 x 50 | 30 x 45 | - | - |
| 680 | 35 x 35 | 35 x 45 | - | - |
| | 30 x 45 | - | - | - |
| 1000 | 35 x 50 | - | - | - |

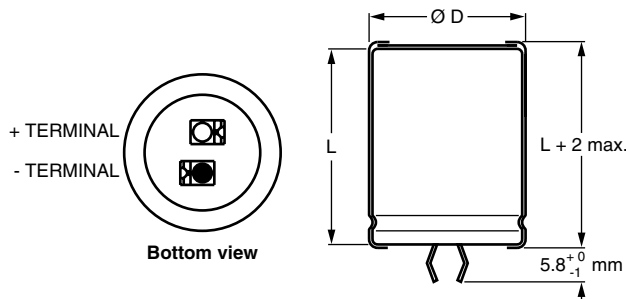
DIMENSIONS in millimeters AND AVAILABLE FORMS
TWO TERMINAL SNAP-IN


Fig.2 Two terminal snap-in

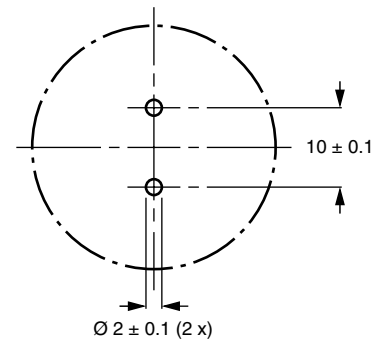


Fig.3 Mounting hole diagram

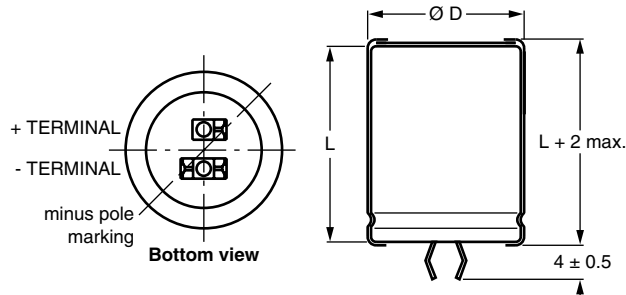
THREE TERMINAL SNAP-IN


Fig.4 Three terminal snap-in

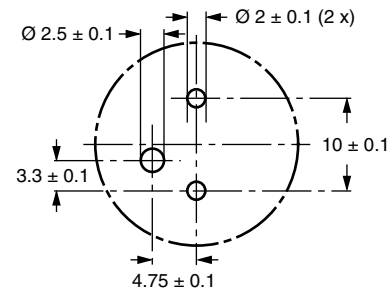


Fig.5 Mounting hole diagram

The minus terminal can be marked with a black dot or with an imprinted '-' sign.

The negative terminal has **TWO** pins which are **BOTH** electrically connected.

The 10 mm spacing of the 2 pin snap-in is used as the base layout and a third hole is added.

The third hole is closer to the negative primary hole so that polarization is always maintained, together with added mechanical stability.

Table 1

| DIMENSIONS IN MILLIMETERS, MASS AND PACKAGING QUANTITIES | | | | | |
|----------------------------------------------------------|-------------------------------|-------------------|----------|--------------------------------------|------------------------------------|
| NOMINAL CASE SIZE $\varnothing D \times L$ | $\varnothing D_{\text{max.}}$ | $L_{\text{max.}}$ | MASS (g) | PACKAGING QUANTITIES (units per box) | CARDBOARD BOX DIMENSIONS L x W x H |
| 22 x 25 | 23 | 27 | ≈ 12 | 100 | 260 x 250 x 39 |
| 22 x 30 | 23 | 32 | ≈ 16 | 100 | 260 x 250 x 44 |
| 22 x 35 | 23 | 37 | ≈ 20 | 100 | 260 x 250 x 49 |
| 22 x 40 | 23 | 42 | ≈ 23 | 100 | 260 x 250 x 54 |
| 25 x 30 | 26 | 32 | ≈ 22 | 100 | 290 x 280 x 44 |
| 25 x 35 | 26 | 37 | ≈ 24 | 100 | 290 x 280 x 49 |
| 25 x 40 | 26 | 42 | ≈ 27 | 100 | 290 x 280 x 54 |
| 25 x 50 | 26 | 52 | ≈ 38 | 100 | 290 x 280 x 64 |
| 30 x 30 | 31 | 32 | ≈ 30 | 100 | 340 x 330 x 44 |
| 30 x 35 | 31 | 37 | ≈ 35 | 100 | 340 x 330 x 49 |
| 30 x 40 | 31 | 42 | ≈ 40 | 100 | 340 x 330 x 54 |
| 30 x 45 | 31 | 47 | ≈ 45 | 100 | 340 x 330 x 59 |
| 30 x 50 | 31 | 52 | ≈ 50 | 100 | 340 x 330 x 64 |
| 35 x 35 | 36 | 37 | ≈ 48 | 50 | 390 x 198 x 49 |
| 35 x 40 | 36 | 42 | ≈ 55 | 50 | 390 x 198 x 54 |
| 35 x 45 | 36 | 47 | ≈ 63 | 50 | 390 x 198 x 59 |
| 35 x 50 | 36 | 52 | ≈ 72 | 50 | 390 x 198 x 64 |

| ELECTRICAL DATA | |
|-----------------|-----------------------------------------------------------|
| SYMBOL | DESCRIPTION |
| C _R | rated capacitance at 100 Hz |
| I _R | rated RMS ripple current at 100 Hz or ≥ 10 kHz and 105 °C |
| I _{L1} | max. leakage current after 1 minute at U _R |
| I _{L5} | max. leakage current after 5 minutes at U _R |
| ESR | max. equivalent series resistance at 100 Hz |
| Z | max. impedance at 10 kHz |

Note

- Unless otherwise specified, all electrical values in Tables 2 and 3 apply at T_{amb} = 20 °C, P = 86 to 106 kPa, RH = 45 to 75 %

Table 2

| ELECTRICAL DATA AND ORDERING INFORMATION FOR 058 SERIES (∅ D x L in mm) | | | | | | | | | | |
|-------------------------------------------------------------------------|----------------------------------|-----------------------------------------|-------------------------------------------|---------------------------------------------|----------------------------------|----------------------------------|-----------------------|--------------------|-------------------------------|---------|
| U _R (V) | C _R 100 Hz (µF) | NOMINAL CASE SIZE ∅ D x L (mm) | I _R 100 Hz 105 °C (A) | I _R ≥ 10 kHz 105 °C (A) | I _{L1} 1 min (µA) | I _{L5} 5 min (µA) | ESR 100 Hz (mΩ) | Z 10 Hz (mΩ) | ORDERING CODE MAL2058..... | |
| | | | | | | | | | 2-TERM. | 3-TERM. |
| 10 | 4700 | 22 x 25 | 1.95 | 2.30 | 286 | 98 | 82 | 57 | 54472E3 | 74472E3 |
| | 6800 | 22 x 30 | 2.44 | 2.88 | 412 | 140 | 61 | 44 | 54682E3 | 74682E3 |
| | 10 000 | 25 x 30 | 2.81 | 3.32 | 604 | 204 | 54 | 42 | 54103E3 | 74103E3 |
| | 10 000 | 22 x 40 | 3.29 | 3.88 | 604 | 204 | 43 | 32 | 44103E3 | 24103E3 |
| | 15 000 | 30 x 30 | 3.53 | 4.17 | 904 | 304 | 42 | 34 | 54153E3 | 74153E3 |
| | 15 000 | 25 x 40 | 3.78 | 4.46 | 904 | 304 | 38 | 30 | 44153E3 | 24153E3 |
| | 22 000 | 30 x 40 | 4.62 | 5.45 | 1324 | 444 | 31 | 25 | 54223E3 | 74223E3 |
| | 22 000 | 25 x 50 | 4.68 | 5.52 | 1324 | 444 | 31 | 24 | 44223E3 | 24223E3 |
| | 33 000 | 35 x 40 | 5.15 | 6.08 | 1984 | 664 | 30 | 24 | 54333E3 | 74333E3 |
| | 33 000 | 30 x 50 | 5.70 | 6.73 | 1984 | 664 | 24 | 21 | 44333E3 | 24333E3 |
| 47 000 | 35 x 50 | 6.23 | 7.35 | 2824 | 944 | 24 | 21 | 54473E3 | 74473E3 | |
| 16 | 3300 | 22 x 25 | 1.90 | 2.24 | 321 | 110 | 86 | 57 | 55332E3 | 75332E3 |
| | 4700 | 22 x 30 | 2.36 | 2.78 | 455 | 154 | 65 | 44 | 55472E3 | 75472E3 |
| | 6800 | 25 x 30 | 2.75 | 3.25 | 657 | 222 | 56 | 42 | 55682E3 | 75682E3 |
| | 6800 | 22 x 40 | 3.18 | 3.75 | 657 | 222 | 46 | 32 | 45682E3 | 25682E3 |
| | 10 000 | 30 x 30 | 3.44 | 4.06 | 964 | 324 | 44 | 34 | 55103E3 | 75103E3 |
| | 10 000 | 25 x 40 | 3.66 | 4.32 | 964 | 324 | 40 | 30 | 45103E3 | 25103E3 |
| | 15 000 | 30 x 40 | 4.55 | 5.37 | 1444 | 484 | 32 | 25 | 55153E3 | 75153E3 |
| | 15 000 | 25 x 50 | 4.55 | 5.37 | 1444 | 484 | 32 | 24 | 45153E3 | 25153E3 |
| | 22 000 | 35 x 40 | 5.07 | 5.98 | 2116 | 708 | 31 | 24 | 55223E3 | 75223E3 |
| | 22 000 | 30 x 50 | 5.67 | 6.69 | 2116 | 708 | 25 | 21 | 45223E3 | 25223E3 |
| 33 000 | 35 x 50 | 6.23 | 7.35 | 3172 | 1060 | 25 | 21 | 55333E3 | 75333E3 | |
| 25 | 2200 | 22 x 25 | 1.76 | 2.08 | 334 | 114 | 100 | 57 | 56222E3 | 76222E3 |
| | 3300 | 22 x 30 | 2.23 | 2.63 | 499 | 169 | 73 | 44 | 56332E3 | 76332E3 |
| | 4700 | 25 x 30 | 2.60 | 3.07 | 709 | 239 | 62 | 42 | 56472E3 | 76472E3 |
| | 4700 | 22 x 40 | 3.00 | 3.54 | 709 | 239 | 52 | 32 | 46472E3 | 26472E3 |
| | 6800 | 30 x 30 | 3.26 | 3.85 | 1024 | 344 | 49 | 34 | 56682E3 | 76682E3 |
| | 6800 | 25 x 40 | 3.49 | 4.12 | 1024 | 344 | 44 | 30 | 46682E3 | 26682E3 |
| | 10 000 | 30 x 40 | 4.37 | 5.16 | 1504 | 504 | 35 | 25 | 56103E3 | 76103E3 |
| | 10 000 | 25 x 50 | 4.37 | 5.16 | 1504 | 504 | 35 | 24 | 46103E3 | 26103E3 |
| | 15 000 | 35 x 40 | 4.91 | 5.79 | 2254 | 754 | 33 | 24 | 56153E3 | 76153E3 |
| | 15 000 | 30 x 50 | 5.43 | 6.41 | 2254 | 754 | 27 | 21 | 46153E3 | 26153E3 |
| 22 000 | 35 x 50 | 6.07 | 7.16 | 3304 | 1104 | 27 | 21 | 56223E3 | 76223E3 | |
| 40 | 1500 | 22 x 25 | 1.65 | 2.01 | 364 | 124 | 114 | 65 | 57152E3 | 77152E3 |
| | 2200 | 22 x 30 | 2.04 | 2.49 | 532 | 180 | 87 | 50 | 57222E3 | 77222E3 |
| | 3300 | 25 x 30 | 2.43 | 2.99 | 796 | 268 | 71 | 45 | 57332E3 | 77332E3 |
| | 3300 | 22 x 40 | 2.78 | 3.39 | 796 | 268 | 60 | 37 | 47332E3 | 27332E3 |
| | 4700 | 30 x 30 | 2.96 | 3.61 | 1132 | 380 | 59 | 40 | 57472E3 | 77472E3 |
| | 4700 | 25 x 40 | 3.26 | 3.90 | 1132 | 380 | 51 | 32 | 47472E3 | 27472E3 |
| | 6800 | 30 x 40 | 3.94 | 4.81 | 1636 | 548 | 42 | 29 | 57682E3 | 77682E3 |
| | 6800 | 25 x 50 | 4.10 | 5.00 | 1636 | 548 | 39 | 26 | 47682E3 | 27682E3 |
| | 10 000 | 35 x 40 | 4.18 | 5.10 | 2404 | 804 | 46 | 29 | 57103E3 | 77103E3 |
| | 10 000 | 30 x 50 | 4.98 | 6.08 | 2404 | 804 | 36 | 24 | 47103E3 | 27103E3 |
| 15 000 | 35 x 50 | 5.21 | 6.36 | 3604 | 1204 | 36 | 24 | 57153E3 | 77153E3 | |

ORDERING EXAMPLE

Electrolytic capacitor 058 series

10 000 µF/25 V; ± 20 %

Nominal case size: ∅ 30 x 40 mm

2-terminal snap-in

Ordering code: MAL205856103E3

Former 12NC: 222205856103

3-terminal snap-in

Ordering code: MAL205876103E3

Former 12NC: 222205876103



| ELECTRICAL DATA AND ORDERING INFORMATION FOR 058 SERIES (Ø D x L in mm) | | | | | | | | | | |
|-------------------------------------------------------------------------|----------------------------------|-----------------------------------------|-------------------------------------------|---------------------------------------------|----------------------------------|----------------------------------|-----------------------|--------------------|-------------------------------|---------|
| U _R (V) | C _R 100 Hz (µF) | NOMINAL CASE SIZE Ø D x L (mm) | I _R 100 Hz 105 °C (A) | I _R ≥ 10 kHz 105 °C (A) | I _{L1} 1 min (µA) | I _{L5} 5 min (µA) | ESR 100 Hz (mΩ) | Z 10 Hz (mΩ) | ORDERING CODE MAL2058..... | |
| | | | | | | | | | 2-TERM. | 3-TERM. |
| 50 | 1000 | 22 x 25 | 1.50 | 1.83 | 304 | 104 | 138 | 69 | 51102E3 | 71102E3 |
| | 1500 | 22 x 30 | 1.88 | 2.29 | 454 | 154 | 102 | 54 | 51152E3 | 71152E3 |
| | 2200 | 25 x 30 | 2.27 | 2.77 | 664 | 124 | 82 | 47 | 51222E3 | 71222E3 |
| | 2200 | 22 x 40 | 2.55 | 3.11 | 664 | 124 | 71 | 38 | 41222E3 | 21222E3 |
| | 3300 | 30 x 30 | 2.81 | 3.43 | 994 | 334 | 66 | 41 | 51332E3 | 71332E3 |
| | 3300 | 25 x 40 | 3.07 | 3.75 | 994 | 334 | 57 | 33 | 41332E3 | 21332E3 |
| | 4700 | 30 x 40 | 3.77 | 4.60 | 1414 | 474 | 47 | 30 | 51472E3 | 71472E3 |
| | 4700 | 25 x 50 | 3.85 | 4.70 | 1414 | 474 | 43 | 27 | 41472E3 | 21472E3 |
| | 6800 | 35 x 40 | 4.01 | 4.89 | 2044 | 684 | 49 | 30 | 51682E3 | 71682E3 |
| | 6800 | 30 x 50 | 4.74 | 5.78 | 2044 | 684 | 38 | 24 | 41682E3 | 21682E3 |
| 10000 | 35 x 50 | 5.04 | 6.15 | 3004 | 1004 | 38 | 24 | 51103E3 | 71103E3 | |
| 63 | 680 | 22 x 25 | 1.17 | 1.43 | 261 | 90 | 228 | 150 | 58681E3 | 78681E3 |
| | 1000 | 22 x 30 | 1.46 | 1.78 | 382 | 130 | 170 | 115 | 58102E3 | 78102E3 |
| | 1500 | 25 x 30 | 1.76 | 2.15 | 571 | 193 | 137 | 85 | 58152E3 | 78152E3 |
| | 1500 | 22 x 40 | 2.00 | 2.44 | 571 | 193 | 115 | 85 | 48152E3 | 28152E3 |
| | 2200 | 30 x 30 | 2.27 | 2.77 | 836 | 281 | 101 | 70 | 58222E3 | 78222E3 |
| | 2200 | 25 x 40 | 2.40 | 2.93 | 836 | 281 | 94 | 70 | 48222E3 | 28222E3 |
| | 3300 | 30 x 40 | 3.07 | 3.75 | 1251 | 420 | 70 | 50 | 58332E3 | 78332E3 |
| | 3300 | 25 x 50 | 3.07 | 3.75 | 1251 | 420 | 70 | 50 | 48332E3 | 28332E3 |
| | 4700 | 35 x 40 | 3.65 | 4.45 | 1781 | 596 | 60 | 45 | 58472E3 | 78472E3 |
| | 4700 | 30 x 50 | 3.88 | 4.73 | 1781 | 596 | 53 | 45 | 48472E3 | 28472E3 |
| 6800 | 35 x 50 | 4.58 | 5.59 | 2574 | 861 | 46 | 35 | 58682E3 | 78682E3 | |
| 100 | 330 | 22 x 25 | 0.92 | 1.12 | 202 | 70 | 370 | 250 | 59331E3 | 79331E3 |
| | 470 | 22 x 30 | 1.14 | 1.39 | 286 | 98 | 280 | 190 | 59471E3 | 79471E3 |
| | 680 | 25 x 30 | 1.35 | 1.65 | 412 | 140 | 232 | 140 | 59681E3 | 79681E3 |
| | 680 | 22 x 40 | 1.57 | 1.92 | 412 | 140 | 190 | 140 | 49681E3 | 29681E3 |
| | 1000 | 30 x 30 | 1.79 | 2.40 | 604 | 204 | 163 | 115 | 59102E3 | 79102E3 |
| | 1000 | 25 x 40 | 1.85 | 2.26 | 604 | 204 | 158 | 115 | 49102E3 | 29102E3 |
| | 1500 | 30 x 40 | 2.45 | 2.99 | 904 | 304 | 111 | 85 | 59152E3 | 79152E3 |
| | 1500 | 25 x 50 | 2.38 | 2.90 | 904 | 304 | 116 | 85 | 49152E3 | 29152E3 |
| | 2200 | 35 x 40 | 3.05 | 3.72 | 1324 | 444 | 86 | 65 | 59222E3 | 79222E3 |
| | 2200 | 30 x 50 | 3.13 | 3.82 | 1324 | 444 | 82 | 65 | 49222E3 | 29222E3 |
| 3300 | 35 x 50 | 3.84 | 4.68 | 1984 | 664 | 64 | 50 | 59332E3 | 79332E3 | |

Table 3

| ELECTRICAL DATA AND ORDERING INFORMATION FOR 059 SERIES | | | | | | | | | | |
|---------------------------------------------------------|----------------------------------|-----------------------------------------|-------------------------------------------|----------------------------------|----------------------------------|------------------------|---------------------|-------------------------------|---------|--|
| U _R (V) | C _R 100 Hz (µF) | NOMINAL CASE SIZE Ø D x L (mm) | I _R 100 Hz 105 °C (A) | I _{L1} 1 min (µA) | I _{L5} 5 min (µA) | ESR 100 kHz (µΩ) | Z 10 kHz (mΩ) | ORDERING CODE MAL2059..... | | |
| | | | | | | | | 2-TERM. | 3-TERM. | |
| 200 | 100 | 22 x 25 | 0.53 | 124 | 44 | 1280 | 730 | 52101E3 | 72101E3 | |
| | 150 | 22 x 30 | 0.67 | 184 | 64 | 850 | 540 | 52151E3 | 72151E3 | |
| | 220 | 22 x 35 | 0.86 | 268 | 92 | 610 | 430 | 32221E3 | 12221E3 | |
| | 220 | 25 x 30 | 0.87 | 268 | 92 | 610 | 430 | 52221E3 | 72221E3 | |
| | 330 | 30 x 30 | 1.12 | 400 | 136 | 435 | 300 | 52331E3 | 72331E3 | |
| | 330 | 25 x 40 | 1.12 | 400 | 136 | 435 | 300 | 42331E3 | 22331E3 | |
| | 470 | 30 x 35 | 1.46 | 568 | 192 | 335 | 225 | 32471E3 | 12471E3 | |
| | 470 | 25 x 50 | 1.25 | 568 | 192 | 335 | 225 | 42471E3 | 22471E3 | |
| | 680 | 30 x 45 | 1.87 | 820 | 276 | 235 | 155 | 32681E3 | 12681E3 | |
| | 680 | 35 x 35 | 1.85 | 820 | 276 | 235 | 155 | 62681E3 | 82681E3 | |
| 1000 | 35 x 50 | 2.45 | 1204 | 404 | 160 | 125 | 52102E3 | 72102E3 | | |
| 250 | 68 | 22 x 25 | 0.49 | 106 | 38 | 1640 | 760 | 53689E3 | 73689E3 | |
| | 100 | 22 x 30 | 0.62 | 154 | 54 | 1110 | 570 | 53101E3 | 73101E3 | |
| | 150 | 22 x 35 | 0.82 | 229 | 79 | 795 | 440 | 33151E3 | 13151E3 | |
| | 150 | 25 x 30 | 0.82 | 229 | 79 | 795 | 440 | 53151E3 | 73151E3 | |
| | 220 | 25 x 35 | 1.03 | 334 | 114 | 540 | 300 | 33221E3 | 13221E3 | |
| | 220 | 30 x 30 | 1.06 | 334 | 114 | 540 | 300 | 53221E3 | 73221E3 | |
| | 330 | 30 x 35 | 1.43 | 499 | 169 | 385 | 225 | 33331E3 | 13331E3 | |
| | 330 | 25 x 50 | 1.40 | 499 | 169 | 385 | 225 | 43331E3 | 23331E3 | |
| | 470 | 30 x 45 | 1.79 | 709 | 239 | 270 | 155 | 33471E3 | 13471E3 | |
| | 470 | 35 x 35 | 1.79 | 709 | 239 | 270 | 155 | 63471E3 | 83471E3 | |
| 680 | 35 x 45 | 2.25 | 1024 | 344 | 190 | 125 | 43681E3 | 23681E3 | | |



| ELECTRICAL DATA AND ORDERING INFORMATION FOR 059 SERIES | | | | | | | | | |
|---------------------------------------------------------|----------------------------------|-----------------------------------------|-------------------------------------------|----------------------------------|----------------------------------|------------------------|---------------------|-------------------------------|---------|
| U _R (V) | C _R 100 Hz (μF) | NOMINAL CASE SIZE Ø D x L (mm) | I _R 100 Hz 105 °C (A) | I _{L1} 1 min (μA) | I _{L5} 5 min (μA) | ESR 100 kHz (μΩ) | Z 10 kHz (mΩ) | ORDERING CODE MAL2059..... | |
| | | | | | | | | 2-TERM. | 3-TERM. |
| 385 | 33 | 22 x 25 | 0.32 | 80 | 29 | 3860 | 3000 | 58339E3 | 78339E3 |
| | 47 | 22 x 30 | 0.41 | 113 | 40 | 2710 | 2100 | 58479E3 | 78479E3 |
| | 68 | 22 x 35 | 0.53 | 161 | 56 | 1870 | 1460 | 38689E3 | 18689E3 |
| | 68 | 25 x 30 | 0.52 | 161 | 56 | 1870 | 1460 | 58689E3 | 78689E3 |
| | 100 | 30 x 30 | 0.72 | 235 | 81 | 1270 | 1010 | 58101E3 | 78101E3 |
| | 100 | 25 x 40 | 0.72 | 235 | 81 | 1270 | 1010 | 48101E3 | 28101E3 |
| | 150 | 30 x 40 | 0.99 | 351 | 119 | 850 | 675 | 58151E3 | 78151E3 |
| | 150 | 25 x 50 | 0.99 | 351 | 119 | 850 | 675 | 48151E3 | 28151E3 |
| | 220 | 35 x 40 | 1.31 | 512 | 173 | 580 | 465 | 58221E3 | 78221E3 |
| | 220 | 30 x 50 | 1.31 | 512 | 173 | 580 | 465 | 48221E3 | 28221E3 |
| | 330 | 35 x 50 | 1.75 | 766 | 258 | 390 | 320 | 58331E3 | 78331E3 |
| 400 | 47 | 22 x 30 | 0.30 | 117 | 42 | 4260 | 3490 | 56479E3 | 76479E3 |
| | 68 | 22 x 35 | 0.38 | 167 | 58 | 2950 | 2420 | 36689E3 | 16689E3 |
| | 68 | 25 x 30 | 0.41 | 167 | 58 | 2950 | 2420 | 56689E3 | 76689E3 |
| | 100 | 30 x 30 | 0.55 | 244 | 84 | 2020 | 1660 | 56101E3 | 76101E3 |
| | 100 | 25 x 40 | 0.55 | 244 | 84 | 2020 | 1660 | 46101E3 | 26101E3 |
| | 150 | 30 x 35 | 0.68 | 364 | 124 | 1350 | 1110 | 36151E3 | 16151E3 |
| | 150 | 25 x 50 | 0.78 | 364 | 124 | 1350 | 1110 | 46151E3 | 26151E3 |
| | 220 | 35 x 40 | 0.94 | 532 | 180 | 930 | 760 | 56221E3 | 76221E3 |
| | 220 | 30 x 50 | 0.94 | 532 | 180 | 930 | 760 | 46221E3 | 26221E3 |
| | | 330 | 35 x 50 | 1.25 | 796 | 260 | 620 | 510 | 56331E3 |

| ADDITIONAL ELECTRICAL DATA | | |
|------------------------------------|-----------------------------------|----------------------------------------------------------------|
| PARAMETER | CONDITIONS | VALUE |
| Voltage | | |
| Surge voltage | ≤ 250 V versions | U _s = 1.15 x U _R |
| | ≥ 385 V versions | U _s = 1.1 x U _R |
| Reverse voltage | | U _{rev} ≤ 1 V |
| Current | | |
| Leakage current | After 1 minute at U _R | I _{L1} ≤ 0.006 C _R x U _R + 4 μA |
| | After 5 minutes at U _R | I _{L5} ≤ 0.002 C _R x U _R + 4 μA |
| Inductance | | |
| Equivalent series inductance (ESL) | All case sizes | typ. 19 nH |
| | | max. 25 nH |

CAPACITANCE (C)

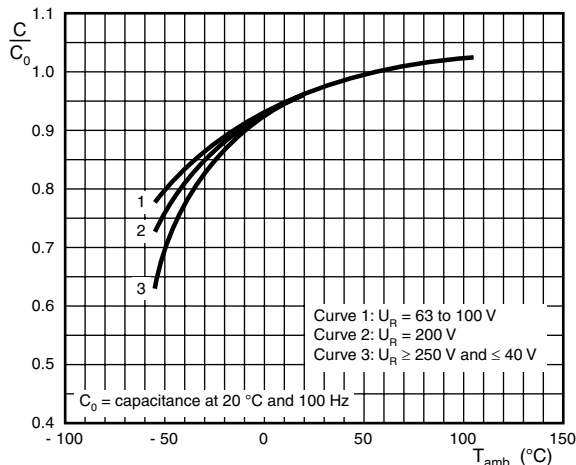


Fig.6 Typical multiplier of capacitance as a function of ambient temperature

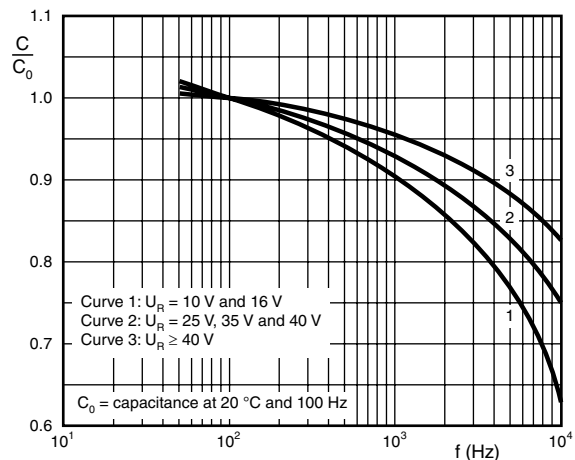


Fig.7 Typical multiplier of capacitance as a function of frequency

EQUIVALENT SERIES RESISTANCE (ESR)

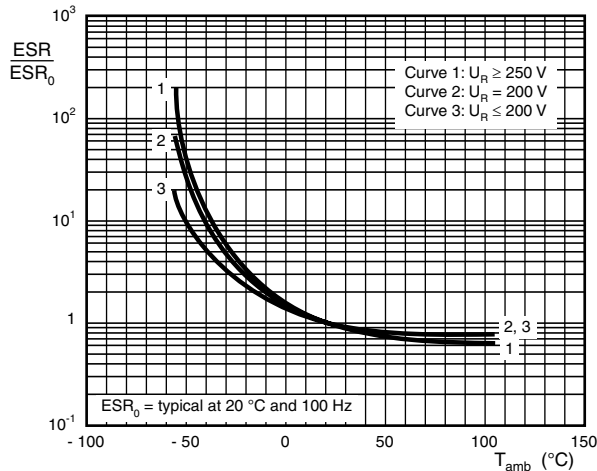


Fig.8 Typical multiplier of ESR as a function of ambient temperature

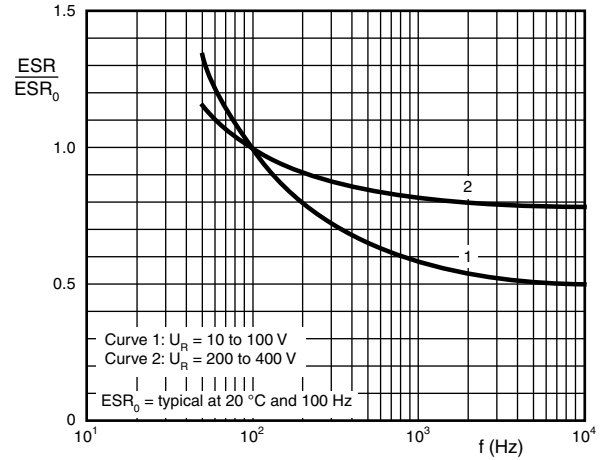


Fig.9 Typical multiplier of ESR as a function of frequency

IMPEDANCE (Z)

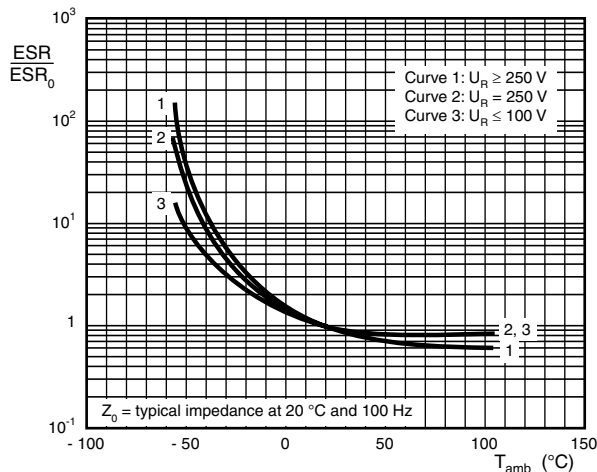


Fig.10 Typical multiplier of impedance as a function of ambient temperature

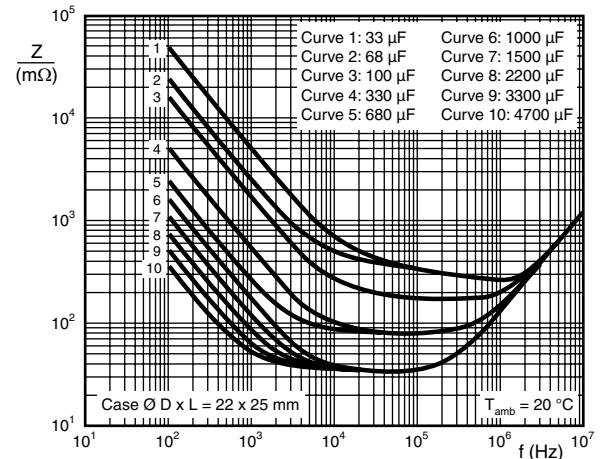


Fig.11 Typical impedance as a function of frequency

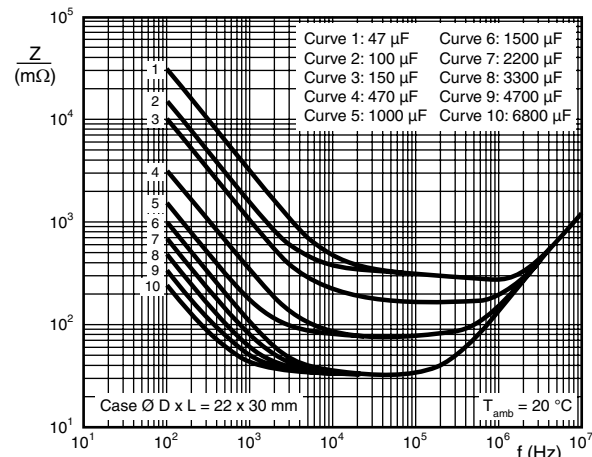


Fig.12 Typical impedance as a function of frequency

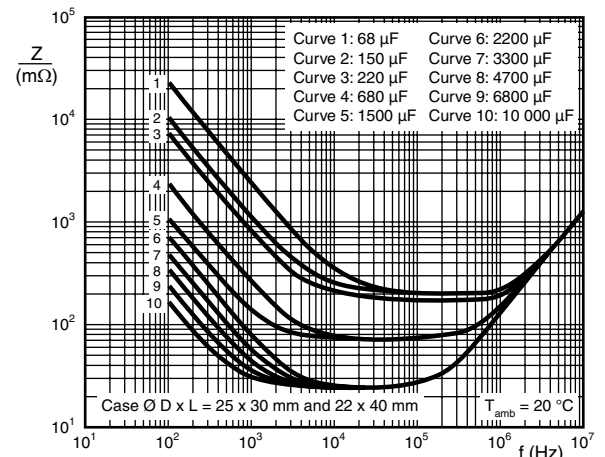


Fig.13 Typical impedance as a function of frequency



IMPEDANCE (Z)

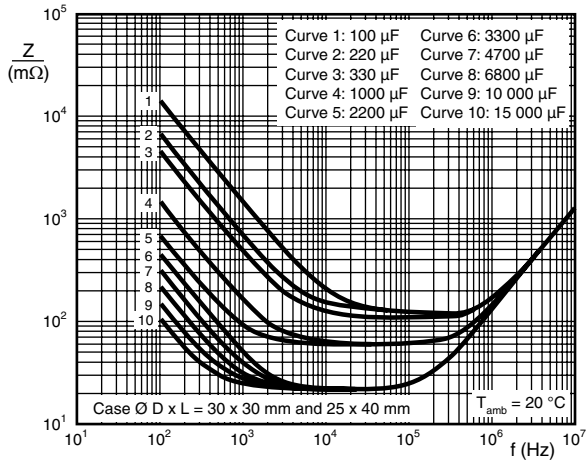


Fig.14 Typical impedance as a function of frequency

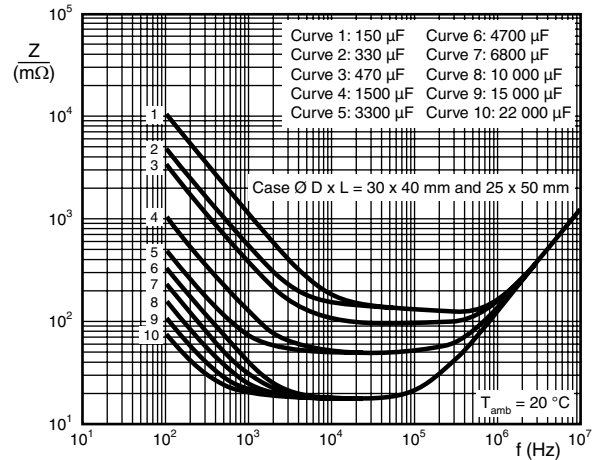


Fig.15 Typical impedance as a function of frequency

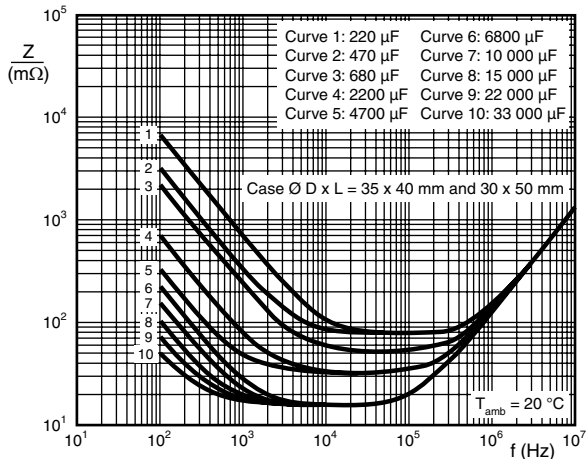


Fig.16 Typical impedance as a function of frequency

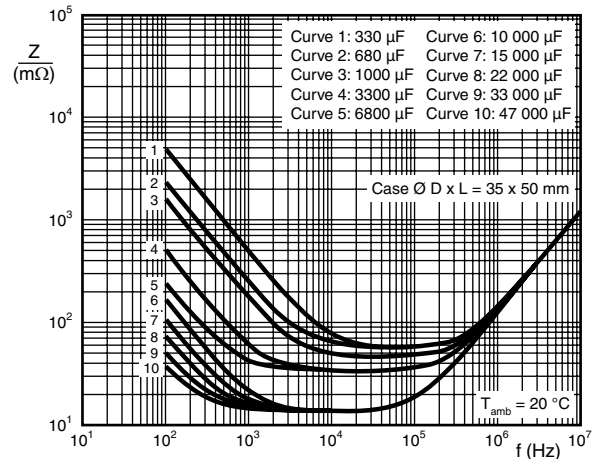
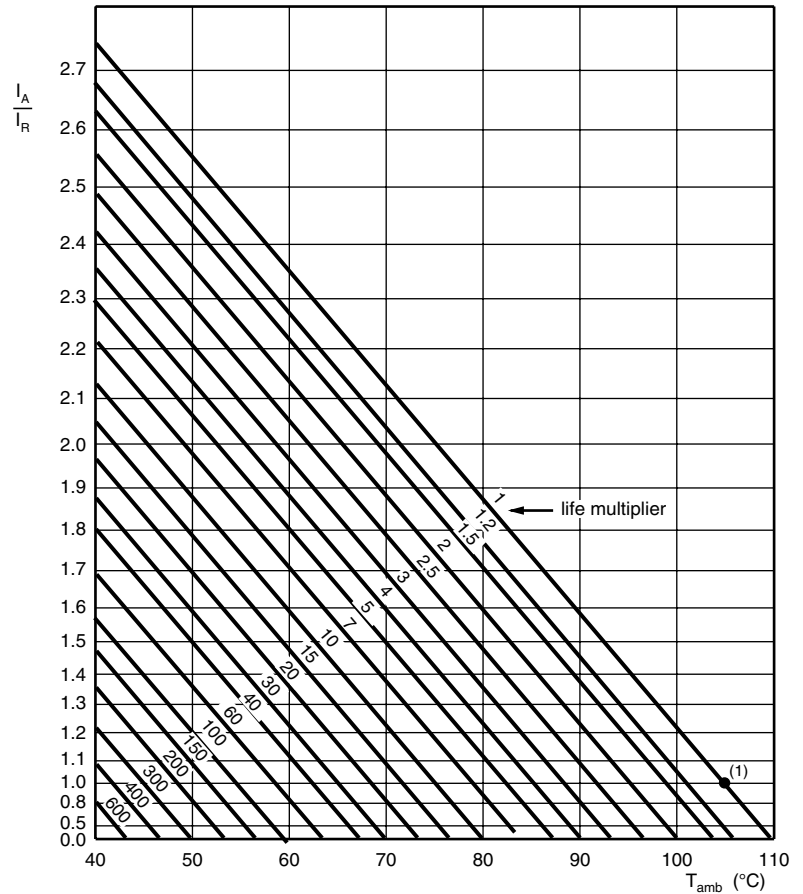


Fig.17 Typical impedance as a function of frequency



RIPPLE CURRENT AND USEFUL LIFE



I_A = actual ripple current at 100 Hz
 I_R = rated ripple current at 100 Hz and 105 °C
 (1) Useful life at 105 °C and I_R applied:
 5000 hours for ≤ 50 V types

Fig.18 Multiplier of useful life as a function of ambient temperature and ripple current load

Table 4

| MULTIPLIER OF RIPPLE CURRENT (I_R) AS A FUNCTION OF FREQUENCY | | | |
|-------------------------------------------------------------------|----------------------|-----------------------|---------------|
| FREQUENCY (Hz) | I_R MULTIPLIER | | |
| | $U_R = 10$ to 25 V | $U_R = 40$ to 100 V | $U_R > 100$ V |
| 50 | 0.93 | 0.91 | 0.86 |
| 100 | 1.00 | 1.00 | 1.00 |
| 200 | 1.04 | 1.05 | 1.13 |
| 400 | 1.07 | 1.09 | 1.21 |
| 1000 | 1.11 | 1.13 | 1.29 |
| 2000 | 1.13 | 1.15 | 1.32 |
| 4000 | 1.15 | 1.18 | 1.35 |
| $\geq 10\ 000$ | 1.18 | 1.22 | 1.40 |

Table 5

| TEST PROCEDURES AND REQUIREMENTS | | | |
|------------------------------------------------|--------------------------------------------|-----------------------------------------------------------------------------------------------------------------------------------------------------------------------------|---------------------------------------------------------------------------------------------------------------------------------------------------------------------------------------------------------------------------------------------------------------------------------------------------------------------------------------------------|
| TEST | | PROCEDURE (quick reference) | REQUIREMENTS |
| NAME OF TEST | REFERENCE | | |
| Endurance | IEC 60384-4/ EN130300 subclause 4.13 | $T_{amb} = 105\text{ }^{\circ}\text{C}$; U_R applied; $\leq 50\text{ V}$ types: 2000 hours; $\geq 63\text{ V}$ types: 5000 hours | $U_R \leq 100\text{ V}$; $\Delta C/C$: $\pm 15\%$ $U_R > 100\text{ V}$; $\Delta C/C$: $\pm 10\%$ $ESR \leq 1.3 \times \text{spec. limit}$ $Z \leq 2 \times \text{spec. limit}$ $I_{L5} \leq \text{spec. limit}$ |
| Useful life | CECC 30301 subclause 1.8.1 | $T_{amb} = 105\text{ }^{\circ}\text{C}$; U_R and I_R applied; $\leq 50\text{ V}$ types: 5000 hours; $\geq 63\text{ V}$ types: 10 000 hours | $U_R \leq 100\text{ V}$; $\Delta C/C$: $\pm 45\%$ $U_R > 100\text{ V}$; $\Delta C/C$: $\pm 30\%$ $ESR \leq 3 \times \text{spec. limit}$ $Z \leq 3 \times \text{spec. limit}$ $I_{L5} \leq \text{spec. limit}$ no short or open circuit, no visible damage total failure percentage; $U_R > 100\text{ V}$: $\leq 3\%$ |
| Shelf life (storage at high temperature) | IEC 60384-4/ EN130300 subclause 4.17 | $T_{amb} = 105\text{ }^{\circ}\text{C}$; no voltage applied; 500 hours After test: U_R to be applied for 30 minutes 24 hours to 48 hours before measurement | $\Delta C/C$: $\pm 10\%$ $ESR \leq 1.2 \times \text{spec. limit}$ $I_{L5} \leq 2 \times \text{spec. limit}$ |



Disclaimer

All product specifications and data are subject to change without notice.

Vishay Intertechnology, Inc., its affiliates, agents, and employees, and all persons acting on its or their behalf (collectively, "Vishay"), disclaim any and all liability for any errors, inaccuracies or incompleteness contained herein or in any other disclosure relating to any product.

Vishay disclaims any and all liability arising out of the use or application of any product described herein or of any information provided herein to the maximum extent permitted by law. The product specifications do not expand or otherwise modify Vishay's terms and conditions of purchase, including but not limited to the warranty expressed therein, which apply to these products.

No license, express or implied, by estoppel or otherwise, to any intellectual property rights is granted by this document or by any conduct of Vishay.

The products shown herein are not designed for use in medical, life-saving, or life-sustaining applications unless otherwise expressly indicated. Customers using or selling Vishay products not expressly indicated for use in such applications do so entirely at their own risk and agree to fully indemnify Vishay for any damages arising or resulting from such use or sale. Please contact authorized Vishay personnel to obtain written terms and conditions regarding products designed for such applications.

Product names and markings noted herein may be trademarks of their respective owners.

Компания «Океан Электроники» предлагает заключение долгосрочных отношений при поставках импортных электронных компонентов на взаимовыгодных условиях!

Наши преимущества:

- Поставка оригинальных импортных электронных компонентов напрямую с производств Америки, Европы и Азии, а так же с крупнейших складов мира;
- Широкая линейка поставок активных и пассивных импортных электронных компонентов (более 30 млн. наименований);
- Поставка сложных, дефицитных, либо снятых с производства позиций;
- Оперативные сроки поставки под заказ (от 5 рабочих дней);
- Экспресс доставка в любую точку России;
- Помощь Конструкторского Отдела и консультации квалифицированных инженеров;
- Техническая поддержка проекта, помощь в подборе аналогов, поставка прототипов;
- Поставка электронных компонентов под контролем ВП;
- Система менеджмента качества сертифицирована по Международному стандарту ISO 9001;
- При необходимости вся продукция военного и аэрокосмического назначения проходит испытания и сертификацию в лаборатории (по согласованию с заказчиком);
- Поставка специализированных компонентов военного и аэрокосмического уровня качества (Xilinx, Altera, Analog Devices, Intersil, Interpoint, Microsemi, Actel, Aeroflex, Peregrine, VPT, Syfer, Eurofarad, Texas Instruments, MS Kennedy, Miteq, Cobham, E2V, MA-COM, Hittite, Mini-Circuits, General Dynamics и др.);

Компания «Океан Электроники» является официальным дистрибьютором и эксклюзивным представителем в России одного из крупнейших производителей разъемов военного и аэрокосмического назначения «**JONHON**», а так же официальным дистрибьютором и эксклюзивным представителем в России производителя высокотехнологичных и надежных решений для передачи СВЧ сигналов «**FORSTAR**».



JONHON

«**JONHON**» (основан в 1970 г.)

Разъемы специального, военного и аэрокосмического назначения:

(Применяются в военной, авиационной, аэрокосмической, морской, железнодорожной, горно- и нефтедобывающей отраслях промышленности)

«**FORSTAR**» (основан в 1998 г.)

ВЧ соединители, коаксиальные кабели,
кабельные сборки и микроволновые компоненты:

(Применяются в телекоммуникациях гражданского и специального назначения, в средствах связи, РЛС, а так же военной, авиационной и аэрокосмической отраслях промышленности).



Телефон: 8 (812) 309-75-97 (многоканальный)

Факс: 8 (812) 320-03-32

Электронная почта: ocean@oceanchips.ru

Web: <http://oceanchips.ru/>

Адрес: 198099, г. Санкт-Петербург, ул. Калинина, д. 2, корп. 4, лит. А