

V680 Series

RFID Systems with ISO/IEC 18000-3 (15693) Compliance

- High-speed communications and highly reliable communications provided with an electromagnetic induction system and unique technology.
- Antennas and RF Tags with excellent environmental resistance.
- Wide line-up of ultra-compact, long-life RF Tags, with capacities from 1 to 8 kbytes.
- Visualizes the communications status for simple analysis of the operating environment.
- Complies with FCC Rules and R&TTE Directive.



System Configuration

Connect V680 Antennas and Amplifier Units to a V680-series Controller, and read or write data from or to RF Tags.



* For information on the combinations that can be used, refer to *Combinations of Amplifier Units, Antennas, and RF Tags* on page 3.

V680 Series

Handheld Type

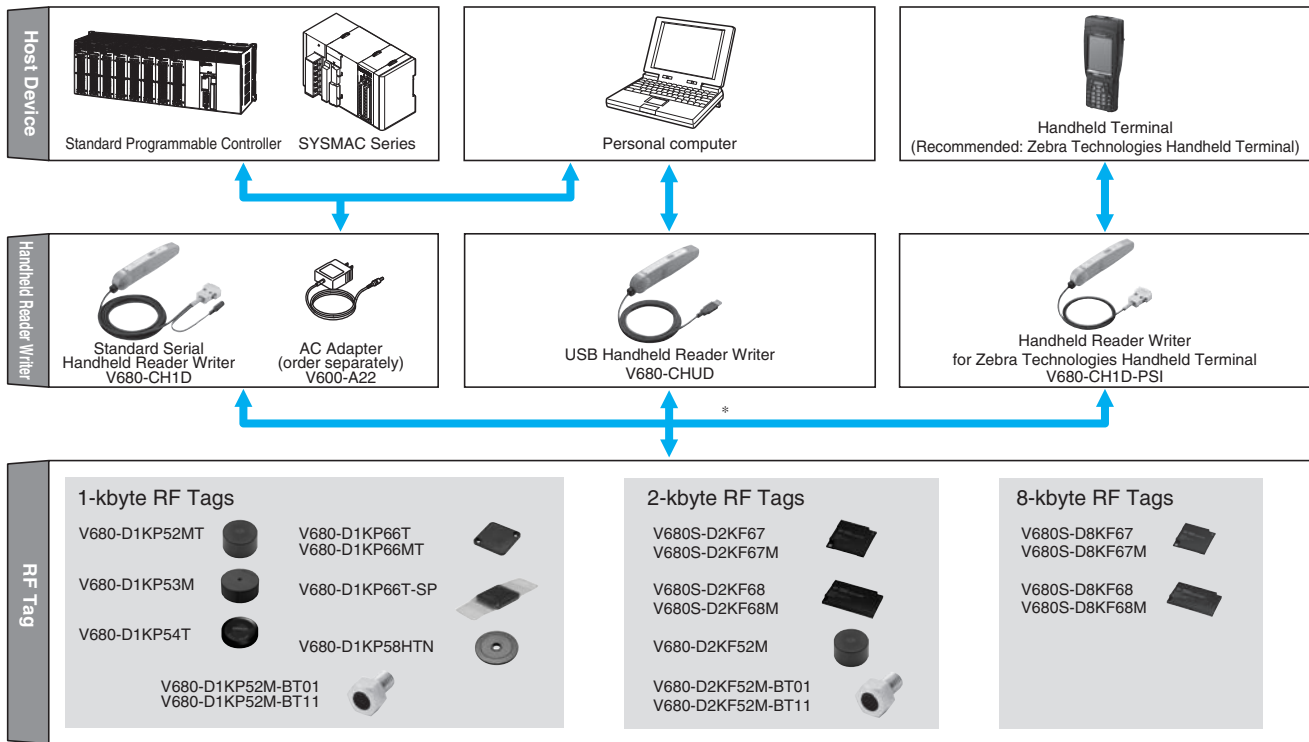

Note: Certificated as type approval of radio in 51 countries including Japan, European countries and the USA . However, some models cannot be used. Contact your OMRON sales representative for details on whether application is supported in other countries.

The latest information on the status of certification for radio wave regulations in various countries can be confirmed on the OMRON website.

* For information on the combinations that can be used, refer to *Combinations of Amplifier Units, Antennas, and RF Tags* on page 3.

Combinations of Amplifier Units, Antennas, and RF Tags

1-kbyte RF Tags

| Amplifier Unit | Antenna | EEP-ROM | | | | | | | |
|---|-------------|---------------|--------------|--------------|--------------|---------------|-----------------|----------------|-------------------|
| | | 1-kbyte | | | | | | | |
| | | V680-D1KP52MT | V680-D1KP53M | V680-D1KP54T | V680-D1KP66T | V680-D1KP66MT | V680-D1KP66T-SP | V680-D1KP58HTN | V680-D1KP52M-BT□1 |
| | | | | | | | | | |
| V680-HA63A V680-HAM42-DRT V680-HAM□1 | V680-HS51 | Yes | Yes | | | | | | Yes |
| | V680-HS52-□ | Yes | Yes | Yes | Yes | Yes | Yes | | Yes |
| | V680-HS63-□ | Yes* | | Yes | Yes | Yes | Yes | | |
| | V680-HS65-□ | | | Yes | Yes | Yes | Yes | Yes | |
| V680-HAM42-PRT | V680-HS63-W | Yes* | | | Yes | Yes | Yes | | |
| | V680-HS65-W | | | | Yes | Yes | Yes | | |
| V680-H01-V2 (Antenna with Built-in Amplifier) | | | | | Yes | | | Yes | |
| V680-CH□D (Handheld Reader Writer) | | Yes | Yes | | Yes | Yes | Yes | Yes | |

2-kbyte RF Tags

| Amplifier Unit | Antenna | FRAM | | | | | |
|---|-------------|--------------|-------------------|--------------|---------------|--------------|---------------|
| | | 2-kbyte | | | | | |
| | | V680-D2KF52M | V680-D2KF52M-BT□1 | V680S-D2KF67 | V680S-D2KF67M | V680S-D2KF68 | V680S-D2KF68M |
| | | | | | | | |
| V680-HA63B V680-HAM42-DRT V680-HAM□1 | V680-HS51 | Yes | Yes | | | | |
| | V680-HS52-□ | Yes | Yes | Yes | Yes | | |
| | V680-HS63-□ | Yes* | | Yes | Yes | Yes | Yes |
| | V680-HS65-□ | | | Yes | Yes | Yes | Yes |
| V680-HAM42-PRT | V680-HS63-W | | | Yes | Yes | Yes | Yes |
| | V680-HS65-W | | | Yes | Yes | Yes | Yes |
| V680-H01-V2 (Antenna with Built-in Amplifier) | | | | Yes | | Yes | |
| V680-CH□D (Handheld Reader Writer) | | Yes | | Yes | Yes | Yes | Yes |

8-kbyte RF Tags

| Amplifier Unit | Antenna | FRAM | | | |
|---|-------------|--------------|---------------|--------------|---------------|
| | | 8-kbyte | | | |
| | | V680S-D8KF67 | V680S-D8KF67M | V680S-D8KF68 | V680S-D8KF68M |
| | | | | | |
| V680-HA63B V680-HAM42-DRT V680-HAM□1 | V680-HS51 | | | | |
| | V680-HS52-□ | Yes | Yes | | |
| | V680-HS63-□ | Yes | Yes | Yes | Yes |
| | V680-HS65-□ | Yes | Yes | Yes | Yes |
| V680-HAM42-PRT | V680-HS63-W | Yes | Yes | Yes | Yes |
| | V680-HS65-W | Yes | Yes | Yes | Yes |
| V680-H01-V2 (Antenna with Built-in Amplifier) | | Yes | | Yes | |
| V680-CH□D (Handheld Reader Writer) | | Yes | Yes | Yes | Yes |

Note: For details, refer to the relevant user's manual (Z248, Z249, Z262, Z271, Z272, Z278, Z279, and Z339).

* When using the V680-D1KP52MT or V680-D2KF52M embedded in metal, use the V680-HS51/-HS52 Antenna.

Communications will not be possible if the V680-HS63 Antenna is used.

Communications will not be possible if the V680-HS65 Antenna is used with the V680-D1KP52MT, V680-D1KP53M, or V680-D2KF52M.

Communication is also possible with RF Tags other than those of the V680 Series as long as they comply with ISO/IEC 18000-3 (ISO/IEC 15693). However, communication with RF Tags other than those of the V680 Series cannot be assured. The user must confirm communication capabilities carefully prior to use.

V680 Series







Ordering Information

RF Tag

| Type | Memory capacity | Appearance | Size | Metallic compatibility | Model | |
|---|---|---|---|---|---|----------------------|
| Battery-less | 1 kbyte |  | 8 dia. × 5 mm | For embedding in metallic or non-metallic surface | V680-D1KP52MT | |
| | |  | 10 dia. × 4.5 mm | For embedding in metallic or non-metallic surface | V680-D1KP53M | |
| | |  | 20 dia. × 2.7 mm | For flush mounting on non-metallic surface | V680-D1KP54T | |
| | |  | 34 × 34 × 3.5 mm | For flush mounting on metallic surface | V680-D1KP66MT | |
| | | | | For flush mounting on non-metallic surface | V680-D1KP66T | |
| | |  | 95 × 36.5 × 6.5 mm | For flush mounting on non-metallic surface | V680-D1KP66T-SP | |
| | |  | 80 dia. × t10 mm | For flush mounting on non-metallic surface | V680-D1KP58HTN | |
| |  | M10 × 12 mm | For mounting as bolts | V680-D1KP52M-BT01 * | | |
| | | M8 × 12 mm | | V680-D1KP52M-BT11 * | | |
| | 2 kbytes | 8 kbytes |  | 8 dia. × 5 mm | For embedding in metallic or non-metallic surface | V680-D2KF52M |
| | | |  | 40 × 40 × 5 mm | For flush mounting on metallic surface | V680S-D2KF67M |
| | | For flush mounting on non-metallic surface | | | V680S-D2KF67 | |
| | |  | 86 × 54 × 10 mm | For flush mounting on metallic surface | V680S-D2KF68M | |
| | | | | For flush mounting on nonmetallic surface | V680S-D2KF68 | |
| | |  | M10 × 12 mm | For mounting as bolts | V680-D2KF52M-BT01 * | |
| | | | M8 × 12 mm | | V680-D2KF52M-BT11 * | |
| | 8 kbytes |  | 40 × 40 × 5 mm | For flush mounting on metallic surface | V680S-D8KF67M | |
| | | | | For flush mounting on non-metallic surface | V680S-D8KF67 | |
|  | | 86 × 54 × 10 mm | For flush mounting on metallic surface | V680S-D8KF68M | | |
| | | | For flush mounting on nonmetallic surface | V680S-D8KF68 | | |

* Place orders in units of boxes (containing 20 units).

Antenna (Detachable Amplifier Unit Type)



| Type | Appearance | Size | Cable length | Model | | |
|--|--|-----------------|--|--|-------------------|-------------------|
| Cylindrical | Standard cable, waterproof connector  | M22 × 65 mm | 2 m | V680-HS52-W 2M | | |
| | | | 12.5 m | V680-HS52-W 12.5M | | |
| | Flexible cable, nonwaterproof connector  | | 2 m | V680-HS52-R 2M | | |
| | | | 12.5 m | V680-HS52-R 12.5M | | |
| Standard cable, nonwaterproof connector  | M12 × 35 mm | 2 m | V680-HS51 2M | | | |
| Square | Standard cable, waterproof connector  | 40 × 53 × 23 mm | 2 m | V680-HS63-W 2M | | |
| | | | 12.5 m | V680-HS63-W 12.5M | | |
| | | | Flexible cable, nonwaterproof connector  | 2 m | V680-HS63-R 2M | |
| | | | | 12.5 m | V680-HS63-R 12.5M | |
| | Standard cable, waterproof connector  | | 100 × 100 × 30 mm | 2 m | V680-HS65-W 2M | |
| | | | | 12.5 m | V680-HS65-W 12.5M | |
| | | | | Flexible cable, nonwaterproof connector  | 2 m | V680-HS65-R 2M |
| | | | | | 12.5 m | V680-HS65-R 12.5M |

Antenna with Built-in Amplifier

| Type | Appearance | Size | Cable length | Model |
|--------|--|-------------------|--------------|-------------|
| Square |  | 250 × 200 × 35 mm | 0.5 m * | V680-H01-V2 |

* Use an Antenna Cable to connect the Antenna to the Controller.
The maximum cable length is 30.5 m.

Amplifier Unit

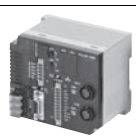

| Type | Appearance | Size | Cable length | Model | | |
|-----------------------|---|-----------------|---|-----------------|-------|-----------------|
| For 1-kbyte memory |  | 25 × 40 × 65 mm | 0.5 m | V680-HA63A 0.5M | | |
| | | | 5 m | V680-HA63A 5M | | |
| | | | 10 m | V680-HA63A 10M | | |
| For 2-/8-kbyte memory | | |  | 25 × 40 × 65 mm | 0.5 m | V680-HA63B 0.5M |
| | | | | | 5 m | V680-HA63B 5M |
| | | | | | 10 m | V680-HA63B 10M |

ID Controller

| Type | No. of connectable Amplifiers | Appearance | Size | Communication interface | Model |
|-----------------|-------------------------------|---|------------------|-------------------------|----------------|
| DC power supply | Single |  | 105 × 90 × 65 mm | RS232C, RS422/RS485 | V680-CA5D01-V2 |
| | Dual |  | | | V680-CA5D02-V2 |

V680 Series

RFID Units

| RFID Units | Appearance | Product name | Amplifier/Antenna | No. of unit numbers used | Model |
|-------------------------|---|--------------|-------------------|--------------------------|------------------|
| NX-series RFID Units |  | RFID Units | V680 series | 1 | NX-V680C1 |
| |  | | | 2 | NX-V680C2 |

ID Sensor Units

| Type | Appearance | Connected ID System | External power supply | No. of unit numbers used | Current consumption (A) | | | Model |
|---------------------------|---|---------------------|-----------------------|--------------------------|-------------------------|--------|----------|---------------------|
| | | | | | 5 V | 24 V | External | |
| CJ Special I/O Unit |  | V680 Series | - | 1 unit number | 0.26 | 0.13 * | - | CJ1W-V680C11 |
| | | | | 2 unit number | 0.32 | 0.26 | - | CJ1W-V680C12 |



| Type | Appearance | Connected ID System | External power supply | No. of unit numbers used | Current consumption (A) | | | Model |
|---------------------------|--|---------------------|-----------------------|--------------------------|-------------------------|--------|----------|---------------------|
| | | | | | 5 V | 26 V | External | |
| CS Special I/O Unit |  | V680 Series | - | 1 unit number | 0.26 | 0.13 * | - | CS1W-V680C11 |
| | | | | 2 unit number | 0.32 | - | 0.36 | CS1W-V680C12 |

* When connected to the V680-H01: 0.28 A

Amplifier-integrated Controller (DeviceNet ID Slave/PROFIBUS ID Slave)

| Appearance | Size | Network Compatibility | Model |
|---|-----------------|-----------------------|-----------------------|
|  | 65 × 65 × 65 mm | DeviceNet | V680-HAM42-DRT |
| | | PROFIBUS | V680-HAM42-PRT |

Amplifier-integrated Controllers (ID Flag Sensors)

| Type | Appearance | Size | Model |
|---------------|---|-----------------|-------------------|
| NPN output |  | 90 × 30 × 65 mm | V680-HAM91 |
| PNP output |  | | V680-HAM81 |

Special Interface Cables (for V680-HAM91 and V680-HAM81)

| Cable length | Model | Appearance |
|--------------|---------------------|---|
| 2 m | V680-A60 2M |  |
| 5 m | V680-A60 5M | |
| 10 m | V680-A60 10M | |

Note: 1. The connectors are not waterproof.

2. The cable length can be extended to a maximum of 10 m.





3. Normally two Interface Cables are required for 1 Unit. If you do not need to write to ID Tags, or use the address shift or noise check functions, then one Interface Cable is sufficient.

Handheld Reader Writers

| Name | Appearance | Model |
|---|---|----------------|
| Model with standard serial connector |  | V680-CH1D |
| Model with USB connector and 0.8-m cable | | V680-CHUD 0.8M |
| Model with USB connector and 1.9-m cable | | V680-CHUD 1.9M |
| Models for Zebra Technologies Handheld Terminal | | V680-CH1D-PSI |
| AC Adapter (for V680-CH1D) | | V600-A22 |

Accessories (Order Separately)

RF Tag Attachment

| Type | Appearance | Model |
|-----------------------------|--|----------|
| For the V680-D1KP66T |  | V600-A86 |
| For the V680-D□KF68 |  | V680-A81 |
| To mount the V680-D1KP58HTN |  | V680-A80 |
| For the V680-D1KP54T |  | V700-A80 |

Amplifier Unit Special Extension Cable (Amplifier Unit to Controller)

| Cable length | Appearance | Model |
|--------------|---|--------------|
| 2 m |  | V700-A40 2M |
| 3 m | | V700-A41 3M |
| 5 m | | V700-A42 5M |
| 10 m | | V700-A43 10M |
| 20 m | | V700-A44 20M |
| 30 m | | V700-A45 30M |

Note: The cable can be extended up to 40 m. Up to two extension cables can be used.

V680-H01 Antenna Special Cable (Antenna to Controller)

| Cable length | Appearance | Model |
|--------------|---|----------------|
| 2 m |  | V700-A40-W 2M |
| 5 m | | V700-A40-W 5M |
| 10 m | | V700-A40-W 10M |
| 20 m | | V700-A40-W 20M |
| 30 m | | V700-A40-W 30M |

Note: The cable can be extended up to 30 m. Only one extension cable can be used.

RS-232C Communications Connector

| Name | Model |
|----------------|---------------|
| Connector Plug | XM3B-0922-111 |
| Connector Hood | XM2S-0911 |

* An RS422/RS485 Communications Connector is attached to the Controller.

ID Map Manager

| Type | Model |
|------------------|---------------------|
| Japanese version | V680-A-IMMJJP-P02 * |
| English version | V680-A-IMMEG-P02 * |
| Chinese version | V680-A-IMMCN-P02 * |

* Supported operating system: Windows 7
For details, consult your OMRON representative.

V680 Series

Ratings and Performance

RF Tag (1-kbyte Memory)

| Item | Model | V680-D1KP52MT | V680-D1KP54T | V680-D1KP66T | V680-D1KP66MT | V680-D1KP53M | V680-D1KP66T-SP |
|--|---|---------------|--|--------------|--|---|--|
| Memory capacity | 1,000 byte (user area) | | | | | | |
| Memory type | EEPROM | | | | | | |
| Data retention time *1 | 10 years after writing (85°C max.) | | | | | | |
| Write endurance | 100,000 times per block (at 25°C) | | | | | | |
| Ambient operating temperature (during communication) | -25 to 85°C (with no icing) | | | | | -25 to 70°C (with no icing) | |
| Ambient storage temperature (during data backup) | -40 to 125°C (with no icing) Heat resistance: 1,000 thermal cycles each of 30 minutes at -10°C/150°C, High-temperature storage: 1,000 hours at 150°C *2 200 thermal cycles each of 30 minutes at -10°C/180°C, High-temperature storage: 200 hours at 180°C *3 | | | | -40 to 125°C (with no icing) | -40 to 110°C (with no icing) | |
| Ambient operating humidity | 35 to 95% | | | | | | |
| Degree of protection | IP68 (IEC 60529:2001) Oil resistance equivalent to IP67G (JIS C 0920:2003, Appendix 1) *4 | | IP67 (IEC 60529:2001) Oil resistance equivalent to IP67G (JIS C 0920:2003, Appendix 1) *4 | | IP68 (IEC 60529:2001) Oil resistance equivalent to IP67G (JIS C 0920:2003, Appendix 1) *4 | | IP67 |
| Vibration resistance | 10 to 2,000 Hz, 1.5-mm double amplitude at 150 m/s ² acceleration with 10 sweeps in X, Y, and Z directions for 15 minutes each | | | | | | |
| Shock resistance | 500 m/s ² in X, Y, and Z directions 3 times each (18 times in total) | | | | | | |
| Appearance | 8 dia. × 5 mm | | 20 dia. × 2.7 mm | | 34 × 34 × 3.5 mm | | 10 dia. × 4.5 mm (DIN698373) 95 × 36.5 × 6.5 mm (excluding protrusions) |
| Materials | Case: PPS resin Filling: Epoxy resin | | Molding: PPS resin | | | Case: PPS resin Filling: Epoxy resin | External resin: PFA Tag body: PPS resin |
| Weight | Approx. 0.5 g | | Approx. 2 g | Approx. 6 g | Approx. 7.5 g | Approx. 1 g | Approx. 20 g |
| Metallic compatibility | Yes | | No | No | Yes | Yes | No |

Note: For details, refer to the User's Manual (Cat. No. Z262).

- *1. Refer to the User's Manual (Cat. No. Z262) for data retention time for temperatures of 85°C or higher. If the V680 has been stored at 125°C or higher, write the data again even if the data does not need to be changed.
- *2. 150°C heat resistance: The heat resistance has been checked at 150°C for up to 1,000 hours, and thermal shock has been checked through testing 1,000 thermal cycles each of 30 minutes at -10/150°C. (Test samples: 22, defects: 0)
- *3. 180°C heat resistance: The heat resistance has been checked at 180°C for up to 200 hours, and thermal shock has been checked through testing 200 thermal cycles each of 30 minutes at -10°C/180°C. (Test samples: 22, defects: 0)
- *4. Oil resistance has been tested using a specific oil as defined in the OMRON test method.

RF Tag with 1-kbyte Memory with High-temperature Capability

| Item | Model | V680-D1KP58HTN |
|-------------------------------|---|----------------|
| Memory capacity | 1,000 bytes (user area) | |
| Memory type | EEPROM | |
| Data Retention | 10 years after writing (85°C or less), 0.5 year after writing (85°C to 125°C) Total data retention at high temperatures exceeding 125°C is 10 hours *1 | |
| Write Endurance | 100,000 times per block (25°C) | |
| Ambient operating temperature | -25°C to 85°C (with no icing) | |
| Ambient storage temperature | -40 to 250°C (with no icing) *2 (Data retention: -40 to 125°C) 1. 2,000 cycles of 30 minutes each between room temperature and 200°C 2. 500 hours at 250°C | |
| Ambient storage humidity | No restrictions. | |
| Degree of protection | IP67 (IEC 60529:2001) Oil resistance equivalent to IP67G (JIS C 0920:2003, Appendix 1) *3 | |
| Vibration resistance | 10 to 2,000 Hz, 1.5-mm double amplitude, acceleration: 150 m/s ² , 10 sweeps each in X, Y, and Z directions for 15 minutes each | |
| Shock resistance | 500 m/s ² , 3 times each in X, Y, and Z directions (total: 18 times) | |
| Materials | PPS resin | |
| Weight | Approx. 70 g | |

- *1 After storing data at high temperatures, rewrite the data even if changes are not required. High temperatures are those exceeding 125°C up to 250°C.
- *2 Storing RF Tags under high temperatures or under heat cycles will adversely affect the performance of the internal parts and the service life of the RF Tags. The RF Tag were placed in the following high temperatures and then evaluated in-house. It was confirmed that no problems occurred.
 1. 2,000 cycles of 30 minutes each between room temperature and 200°C.
 2. 500 hours at 250°C.
- *3 Oil resistance has been tested using a specific oil as defined in the OMRON test method.

RF Tag (2-kbyte Memory)

| Item | Model | V680S-D2KF67 | V680S-D2KF67M | V680S-D2KF68 | V680S-D2KF68M | V680-D2KF52M |
|-------------------------------|-------|---|----------------|--|---------------|---|
| Memory capacity | | 2,000 bytes (user area) | | | | |
| Memory type | | FRAM | | | | |
| Data retention time *1 | | 10 years after writing at 85°C | | | | 10 years after writing (55°C max.) |
| Write endurance | | One trillion writes for each block(85°C or less), Number of accesses *2: One trillion writes | | | | Access frequency per block *2: 10 billion times |
| Ambient operating temperature | | -20 to 85°C (with no icing) | | | | -25 to 85°C (with no icing) |
| Ambient storage temperature | | -40 to 125°C (with no icing) | | | | -40 to 125°C (with no icing) |
| Ambient operating humidity | | 35 to 85% | | | | 35 to 95% |
| Degree of protection | | IP68 (IEC 60529:2001), Oil resistance equivalent to IP67G (JIS C 0920:2003, Appendix 1) *3 IPX9K (DIN 40 050) | | | | IP67 (IEC 60529:2001) Oil resistance equivalent to IP67G (JIS C 0920:2003, Appendix 1) *3 |
| Vibration resistance | | 10 to 2,000 Hz, 1.5-mm double amplitude at 150 m/s ² acceleration with 10 sweeps in X, Y, and Z directions for 15 minutes each | | No abnormality after application of 10 to 500 Hz, 1.5-mm double amplitude, acceleration: 100 m/s ² , 10 sweeps each in X, Y, and Z directions for 11 minutes each | | 10 to 2,000 Hz, 1.5-mm double amplitude at 150 m/s ² acceleration with 10 sweeps in X, Y, and Z directions for 15 minutes each |
| Shock resistance | | 500 m/s ² in X, Y, and Z directions 3 times each (Total:18 times) | | | | |
| Appearance | | 40 × 40 × 5 mm | | 86 × 54 × 10 mm | | 8 dia. × 5 mm |
| Materials | | Exterior: PPS resin | | | | Case: PPS resin Filling: Epoxy resin |
| Weight | | Approx. 12 g | Approx. 11.5 g | Approx. 44 g | Approx. 46 g | Approx. 0.5 g |
| Metallic compatibility | | No | Yes | No | Yes | Yes |

Note: For details, refer to the User's Manual (Cat. No. Z248 or Z339).

*1. Refer to the User's Manual (Cat. No. Z248) for data retention time for temperatures of 55°C or higher.

*2. The total Read or Write communication frequency is called the access frequency.

*3. Oil resistance has been tested using a specific oil as defined in the OMRON test method.

RF Tag with 8-kbyte Memory

| Item | Model | V680S-D8KF67 | V680S-D8KF67M | V680S-D8KF68 | V680S-D32KF68M |
|-------------------------------|-------|---|---------------|---|----------------|
| Memory capacity | | 8,192 bytes (user area) | | | |
| Memory type | | FRAM | | | |
| Data retention time | | 10 years after writing (85°C or less) | | | |
| Write endurance | | 1 trillion times per block. *1 Access frequency : 1 trillion times: | | | |
| Ambient operating temperature | | -20 to 85°C (with no icing) | | | |
| Ambient storage temperature | | -40 to 125°C (with no icing) | | | |
| Ambient operating humidity | | 35 to 85% | | | |
| Degree of protection | | IP68 (IEC 60529:2001), Oil resistance equivalent to IP67G (JIS C 0920:2003, Appendix 1) *2 IPX9K (DIN 40 050) | | | |
| Vibration resistance | | 10 to 2,000 Hz, 1.5-mm double amplitude at 150 m/s ² acceleration with 10 sweeps in X, Y, and Z directions for 15 minutes each | | 10 to 500 Hz, 1.5-mm double amplitude at 100 m/s ² acceleration with 10 sweeps in X, Y, and Z directions for 11 minutes each | |
| Shock resistance | | 500 m/s ² in X, Y, and Z directions 3 times each (18 times in total) | | | |
| Dimensions | | 40 × 40 × 4.5 mm | | 86 × 54 × 10 mm | |
| Materials | | Molding: PPS resin | | | |
| Weight | | Approx. 11.5 g | Approx. 12 g | Approx. 44 g | Approx. 46 g |
| Metallic compatibility | | No | Yes | No | Yes |

Note: For details, refer to the User's Manual (Cat. No. Z339).

*1. The total Read or Write communication frequency is called the access frequency.

*2. Oil resistance has been tested using a specific oil as defined in the OMRON test method.

V680 Series

Bolt RF Tags (1-kbyte Memory)

| Item | Model | V680-D1KP52M-BT01 | V680-D1KP52M-BT11 |
|--|-------|---|-------------------|
| Memory capacity | | 1,000 bytes (user area) | |
| Memory type | | EEPROM | |
| Data retention time | | 10 years after writing (85°C or less), 0.5 years after writing (85 to 125°C) Total data retention at high temperatures exceeding 125°C is 10 hours | |
| Write endurance | | 100,000 times per block (at 25°C) | |
| Ambient operating temperature (during communication) | | -25 to 85°C (with no icing) | |
| Ambient storage temperature (during data backup) | | -40 to 125°C (with no icing) | |
| Ambient operating humidity | | 35 to 95% | |
| Degree of protection | | IP68 (IEC 60529:2001) Oil resistance equivalent to IP67G (JIS C 0920:2003, Appendix 1) * | |
| Vibration resistance | | 10 to 2,000 Hz, 1.5-mm double amplitude at 150 m/s ² acceleration with 10 sweeps in X, Y, and Z directions for 15 minutes each | |
| Shock resistance | | 500 m/s ² in X, Y, and Z directions 3 times each (18 times in total) | |
| Materials | | Bolt: SUS303, Case (RF Tag): PPS resin, Filling (RF Tag): Epoxy resin | |
| Weight | | Approx. 25 g | Approx. 10 g |

* Oil resistance has been tested using a specific oil as defined in the OMRON test method.

Bolt RF Tags (2-kbyte Memory)

| Item | Model | V680-D2KF52M-BT01 | V680-D2KF52M-BT11 |
|--|-------|---|-------------------|
| Memory capacity | | 2,000 bytes (user area) | |
| Memory type | | FRAM | |
| Data retention time | | 10 years after writing (55°C or less), 2.9 years after writing (85°C max.) | |
| Write endurance | | 10 billion reads/writes per block, Number of accesses *1: 10 billion times | |
| Ambient operating temperature (during communication) | | -25°C to 85°C (with no icing) | |
| Ambient storage temperature (during data backup) | | -40°C to 85°C (with no icing) | |
| Ambient operating humidity | | 35 to 95% | |
| Degree of protection | | IP67 (IEC 60529:2001) Oil resistance equivalent to IP67G (JIS C 0920:2003, Appendix 1) *2 | |
| Vibration resistance | | 10 to 2,000 Hz, 1.5-mm double amplitude at 150 m/s ² acceleration with 10 sweeps in X, Y, and Z directions for 15 minutes each | |
| Shock resistance | | 500 m/s ² in X, Y, and Z directions 3 times each (18 times in total) | |
| Materials | | Bolt: SUS303, Case (RF Tag): PPS resin, Filling (RF Tag): Epoxy resin | |
| Weight | | Approx. 25 g | Approx. 10 g |

*1 The number of accesses is the total number of communications for reading or writing.

*2 Oil resistance has been tested using a specific oil as defined in the OMRON test method.

Cylindrical Antenna (Detachable Amplifier Unit Type)

| Item | Model | V680-HS51 (Standard Cable, Non-waterproof Connector) | V680-HS52-W (Standard Cable, Waterproof Connector) | V680-HS52-R (Standard Cable, Non-waterproof Connector) |
|-------------------------------|-------|---|--|--|
| Ambient operating temperature | | -10°C to 60°C (with no icing) | | |
| Ambient storage temperature | | -25°C to 75°C (with no icing) | | |
| Ambient operating humidity | | 35% to 95% (with no condensation) | | |
| Insulation resistance | | 20 MΩ min. (at 500 VDC) between the cable terminals and the case | | |
| Dielectric strength | | 1,000 VAC (50/60 Hz) for 1 minute between the cable terminals and the case with a current leakage of 5 mA max. | | |
| Degree of protection | | IP67 (IEC 60529:2001) Oil resistance equivalent to IP67G (JIS C 0920:2003, Appendix 1) (Antenna portion) *2 | IP67 (IEC 60529:2001) Oil resistance equivalent to IP67G (JIS C 0920:2003, Appendix 1) (Antenna portion) *1 | IP67 (IEC 60529:2001) Oil resistance equivalent to IP67G (JIS C 0920:2003, Appendix 1) (Antenna portion) *2 |
| Vibration resistance | | 10 to 2,000 Hz variable vibration, 1.5-mm double amplitude at 150 m/s ² acceleration, with 10 sweeps in X, Y, and Z directions for 15 minutes each | 10 to 500 Hz variable vibration, 1.5-mm double amplitude at 100 m/s ² acceleration, with 10 sweeps in X, Y, and Z directions for 8 minutes each | |
| Shock resistance | | 1,000 m/s ² in X, Y, and Z directions 3 times each (18 times in total) | 500 m/s ² in X, Y, and Z directions 3 times each (18 times in total) | |
| Appearance | | M12 × 35 mm | M22 × 65 mm | |
| Materials | | ABS, brass, epoxy resin filling | | |
| Weight | | Approx. 55 g (with 2-m cable) | Approx. 850 g (with 12.5-m cable) | |

Note: For details, refer to the User's Manual (Cat. No. Z248 or Z262).

*1. The degree of protection for the Connector is IP67/IP65. This OMRON in-house standard confirms resistance to cutting and other oils. It is equivalent to the former JEM1030 standard.

*2. The Connector is not waterproof. Oil resistance has been tested using a specific oil as defined in the OMRON test method.

Square Antenna (Detachable Amplifier Unit Type)

| Item | Model | V680-HS63-W (Standard Cable, Waterproof Connector) | V680-HS63-R (Flexible Cable, Non-waterproof Connector) |
|-------------------------------|-------|---|--|
| Ambient operating temperature | | -10°C to 60°C (with no icing) | |
| Ambient storage temperature | | -25°C to 75°C (with no icing) | |
| Ambient operating humidity | | 35% to 95% (with no condensation) | |
| Insulation resistance | | 20 MΩ min. (at 500 VDC) between the cable terminals and the case | |
| Dielectric strength | | 1,000 VAC (50/60 Hz) for 1 minute between the cable terminals and the case with a current leakage of 5 mA max. | |
| Degree of protection | | IP67 (IEC 60529:2001) Oil resistance equivalent to IP67G (JIS C 0920:2003, Appendix 1) (Antenna portion) *1 | IP67 (IEC 60529:2001) Oil resistance equivalent to IP67G (JIS C 0920:2003, Appendix 1) (Antenna portion) *2 |
| Vibration resistance | | 10 to 500 Hz variable vibration, 1.5-mm double amplitude at 100 m/s ² acceleration, with 10 sweeps in X, Y, and Z directions for 11 minutes each | |
| Shock resistance | | 500 m/s ² in X, Y, and Z directions 3 times each (18 times in total) | |
| Appearance | | 40 × 53 × 23 mm | |
| Materials | | ABS, epoxy resin filling | |
| Weight | | Approx. 850 g (with 12.5-m cable) | |

| Item | Model | V680-HS65-W (Standard Cable, Waterproof Connector) | V680-HS65-R (Flexible Cable, Non-waterproof Connector) |
|-------------------------------|-------|---|--|
| Ambient operating temperature | | -25°C to 70°C (with no icing) | |
| Ambient storage temperature | | -40°C to 85°C (with no icing) | |
| Ambient operating humidity | | 35% to 95% (with no condensation) | |
| Insulation resistance | | 20 MΩ min. (at 500 VDC) between the cable terminals and the case | |
| Dielectric strength | | 1,000 VAC (50/60 Hz) for 1 minute between the cable terminals and the case with a current leakage of 5 mA max. | |
| Degree of protection | | IP67 (IEC 60529:2001) Oil resistance equivalent to IP67G (JIS C 0920:2003, Appendix 1) (Antenna portion) *1 | IP67 (IEC 60529:2001) Oil resistance equivalent to IP67G (JIS C 0920:2003, Appendix 1) (Antenna portion) *2 |
| Vibration resistance | | 10 to 500 Hz variable vibration, 1.5-mm double amplitude at 100 m/s ² acceleration, with 10 sweeps in X, Y, and Z directions for 11 minutes each | |
| Shock resistance | | 500 m/s ² in X, Y, and Z directions 3 times each (18 times in total) | |
| Appearance | | 100 × 100 × 30 mm | |
| Materials | | ABS, epoxy resin filling | |
| Weight | | Approx. 1,100 g (with 12.5-m cable) | |

Note: For details, refer to the User's Manual (Cat. No. Z248 or Z262).

*1. The degree of protection for the Connector is IP67/IP65. Oil resistance has been tested using a specific oil as defined in the OMRON test method.

*2. The Connector is not waterproof. Oil resistance has been tested using a specific oil as defined in the OMRON test method.

V680 Series

Square Antenna with Built-in Amplifier

| Item | Model | V680-H01-V2 |
|-------------------------------|-------|---|
| Ambient operating temperature | | -10°C to 55°C (with no icing) |
| Ambient storage temperature | | -35°C to 65°C (with no icing) |
| Ambient operating humidity | | 35% to 85% (with no condensation) |
| Insulation resistance | | 20 MΩ min. (at 100 VDC) between connector terminals and the rear plate |
| Dielectric strength | | 1,000 VAC, 50/60 Hz for 1 min between connector terminals and the rear plate |
| Degree of protection | | IP63. (IEC60529); Mounting direction: Communications surface facing up |
| Vibration resistance | | 10 to 150 Hz, 0.35-mm single amplitude, acceleration: 50 m/s ² , 10 sweeps in each of 3 axis directions (up/down, left/right, and forward/backward) for 8 minutes each |
| Shock resistance | | 150 m/s ² , 3 times each in 6 directions (Total: 18 times) |
| Appearance | | 200 × 250 × 40 mm |
| Material | | Polycarbonate (PC) resin, ASA resin / Rear Panel: Aluminum |
| Weight | | Approx. 900 g |
| Cable length | | 0.5 m (use a relay cable to connect to the Controller up to 30.5 m) |

Note: For details, refer to the User's Manual (Cat. No. Z248 or Z262).

ID Controller

| Item | Model | V680-CA5D01-V2 | V680-CA5D02-V2 |
|---|-------|---|----------------|
| Power supply voltage (Power consumption) | | 24 VDC (-15% to +10%) 15 W max., 0.8 A max. | |
| Communications Specifications | | RS-232C, RS-422, RS-485 | |
| Input Specifications (Input voltage) RST, TRG1, and TRG2 | | 24 VDC (+10% to -15%, including ripple) (PNP and NPN compatible) | |
| Output Specifications (Maximum switching capacity) RUN, BUSY/OUT3, ERROR/OUT4, OUT1, and OUT2 | | 24 VDC (+10% to -15%, including ripple) PNP and NPN compatible | |
| Ambient operating temperature | | -10 to 55°C (with no icing) | |
| Ambient storage temperature | | -25 to 65°C (with no icing) | |
| Ambient operating humidity | | 25% to 85% (with no condensation) | |
| Insulation resistance | | 20 MΩ min. (at 500 VDC) applied as follows: (1) Between power supply terminals and grounded case (2) Between ground and terminals | |
| Dielectric strength | | 1,000 VAC (50/60 Hz) for 1 minute (1) Between power supply terminals and grounded case (2) Between ground and terminals | |
| Degree of protection | | Panel mounted (equivalent to IP20) | |
| Vibration resistance | | 10 to 150 Hz variable vibration, 0.2-mm double amplitude at 15 m/s ² acceleration, with 10 sweeps in X, Y, and Z directions for 8 minutes each | |
| Shock resistance | | 150 m/s ² | |
| Appearance | | 105 × 90 × 65 mm (not including projections) | |
| Material | | Polycarbonate (PC) resin, ABS resin | |
| Weight | | Approx. 300 g | |
| Connectable Amplifier Units | | 1 | 2 |

Note: For details, refer to the User's Manual (Cat. No. Z249).

USB Port

The USB port is used for a simple connection with a personal computer using a USB cable. The port complies with USB 1.1, and the USB cable uses a series A or series mini-B connector. A USB port driver must be separately provided. Consult with your OMRON representative for details. When connected to a host device via USB, the communications will use 1:1 protocol regardless of the setting of DIP switches 3 to 9.

The USB port is not used for control purposes. When building a system, be sure to provide an RS-232C port or RS-422/RS-485C port.

Amplifier Unit

| Item | Model | V680-HA63A | V680-HA63B |
|-------------------------------|-------|---|-------------------------|
| Ambient operating temperature | | -10°C to 55°C (with no icing) | |
| Ambient storage temperature | | -25°C to 65°C (with no icing) | |
| Ambient operating humidity | | 35% to 85% (with no condensation) | |
| Insulation resistance | | 20 MΩ min. (at 500 VDC) between the cable terminals and the case | |
| Dielectric strength | | 1,000 VAC (50/60 Hz) for 1 minute between the cable terminals and the case with a current leakage of 5 mA max. | |
| Degree of protection | | IP40 (IEC60529) *1 | IP67/IP65 (IEC60529) *2 |
| Vibration resistance | | 10 to 500 Hz variable vibration, 1.5-mm double amplitude at 100 m/s ² acceleration, with 10 sweeps in X, Y, and Z directions for 11 minutes each | |
| Shock resistance | | 500 m/s ² in X, Y, and Z directions 3 times each (18 times in total) | |
| Appearance | | 25 × 40 × 65mm (not including projections) | |
| Material | | Polycarbonate (PC) resin | |
| Weight | | Approx. 650 g (with 10-m cable) | |
| Cable length | | 5 m, 10 m | |
| Transmittable RF Tags | | 1-kbyte memory | 2-, 8-kbyte memory |

Note: For details, refer to the User's Manual (Cat. No. Z248 or Z262).

*1. When connected to the V680-HS□□-R or V680-HS52-R.

*2. When connected to the V680-HS□□-W or V680-HS52-W. (Not including the Connector on the Controller.)

RFID Units

| Item | Model | NX-V680C1 | NX-V680C2 |
|---|---|---|-----------|
| Enclosure | | Mounted in a panel | |
| Grounding Methods | | Ground to less than 100 Ω | |
| Operating environment | Ambient operating temperature | 0 to 55°C | |
| | Ambient operating humidity | 10 to 95% (with no condensation or icing) | |
| | Atmosphere | Must be free from corrosive gases. | |
| | Ambient storage temperature | -25 to 70°C (with no condensation or icing) | |
| | Altitude | 2,000 m max. | |
| | Pollution degree | 2 or less: Conforms to JIS B3502 and IEC 61131-2 | |
| | Noise immunity | 2 kV on power supply line (Conforms to IEC61000-4-4.) | |
| | Overvoltage category | Category II: Conforms to JIS B3502 and IEC 61131-2 | |
| | EMC immunity level | Zone B | |
| | Vibration resistance | Conforms to IEC 60068-2-6. 5 to 8.4 Hz with amplitude of 3.5 mm, 8.4 to 150 Hz, acceleration of 9.8 m/s ² 100 min each in X, Y, and Z directions (10 sweeps of 10 min each = 100 min total) | |
| Shock resistance | Conforms to IEC 60068-2-27, 147 m/s ² , 3 times each in X, Y, and Z directions | | |
| Applicable standards | | cULus: Listed (UL61010-2-201), ANSI/ISA12.12.01, EU: EN61131-2, RCM, KC: KC Registration, EAC | |
| No. of Amplifier/Antenna connections | | 1 | 2 |

RFID Units Functions

| Function name | Model | NX-V680C1/NX-V680C2 |
|---|-------|--|
| RF Communications option function | | This function switches the operation sequence during communications with an RF Tag. |
| Communications command function | | This function reads or writes the memory for a RF Tag on the antenna communications area. |
| Write protection function | | This function prevents the loss of data due to overwriting by specifying the areas in which it is not possible to write to an RF Tag. |
| RF Tag service life detection function | | This function records the number of times data is rewritten to an RF Tag, and determines the maximum rewrite count. |
| RF Tag memory error detection function | | This function detects an error during reading by performing CRC calculation for the memory of an RF Tag. |
| RF Tag memory error correction function | | This function detects an error during reading by performing ECC calculation for the memory of an RF Tag, and corrects the error to an appropriate value. |
| Test command function | | This function checks the margin in communications with an RF Tag, and measures the surrounding noise. |

V680 Series

ID Sensor Units

| Item | Model | CJ1W-V680C11 | CJ1W-V680C12 | CS1W-V680C11 | CS1W-V680C12 |
|-------------------------------|---|--------------|--------------|---|--------------|
| Current consumption | Internal: 5 V | 260 mA | 320 mA | 260 mA | 320 mA |
| | Internal: 24 V/26 V | 130 mA * | 260 mA | 125 mA * | – |
| | External: 24 V | – | – | – | 360 mA |
| Ambient operating temperature | 0 to 55°C | | | | |
| Ambient storage temperature | –20°C to 75°C | | | | |
| Ambient operating humidity | 10% to 90% (with no condensation) | | | | |
| Insulation resistance | 20 mΩ min. at 500 VDC | | | | |
| Dielectric strength | 1,000 VAC for 1 minute | | | | |
| Degree of protection | Mounted in panel (IP30) | | | | |
| Vibration resistance | 10 to 57 Hz variable vibration, 0.075-mm double amplitude and 57 to 150 Hz variable vibration at 9.8 m/s ² acceleration, with 10 sweeps in X, Y, and Z directions for 8 minutes each | | | | |
| Shock resistance | 147 m/s ² in X, Y, and Z directions 3 times each | | | | |
| Appearance | 31 × 65 × 90 mm (excluding protrusions) | | | 35 × 130 × 101 mm (excluding protrusions) | |

* When connected to the V680-H01: 280 mA. The V680-H01-V2 can be connected only to a 1-channel ID Sensor Unit. A 2-channel Unit cannot be used.

Functional Specifications of ID Sensor Units

| Item | Model | CJ1W-V680C11 | CJ1W-V680C12 | CS1W-V680C11 | CS1W-V680C12 |
|---------------------------------|---|--------------|--------------|--------------|--------------|
| Communications control protocol | Special protocol for CS, CJ and NJ PLCs | | | | |
| Number of Antenna connections | 1 | 2 | 1 | 2 | |
| Commands | Supported commands: Read, Write, Bit Set/Bit Clear, Mask Bit Write, Calculation Write, Data Fill, Data Check, Number of Writes Control, Copy (CJ1W-V680C12 and CS1W-V680C12 only), Read with Error Correction/Write with Error Correction, UID Read, and Noise Measurement. The following communications options are supported: Single trigger, Single auto, Repeat auto, FIFO trigger, FIFO repeat *, Multi-access trigger, and Multi-access repeat * | | | | |
| Data transfer quantity | 2,048 bytes max. (160 bytes/scan) | | | | |
| Diagnostic function | (1) CPU watchdog timer (2) Communications error detection with RF Tag (3) Antenna power supply error | | | | |
| Monitoring/testing functions | Tag communications can be tested in Test Mode. Status is displayed by LED indicators. | | | | |
| Number of allocated words | 10 words | 20 words | 10 words | 20 words | |

Note: For details, refer to the User's Manual (Cat. No. Z271).

* Cannot be used for communications with the V680-D1KP□□.

Amplifier-integrated Controller (DeviceNet ID Slave/PROFIBUS ID Slave)

| Item | Model | V680-HAM42-DRT | V680-HAM42-PRT |
|-------------------------------|-------|--|----------------|
| Network compatibility | | DeviceNet | PROFIBUS DP-V0 |
| Connectable Antennas | | One channel (V680-HS□□) | |
| Rated voltage | | 24 VDC (–15% to 10%) including 10% ripple (p-p) | |
| Power consumption | | 4 W max. (Current consumption of 200 mA max. at power supply voltage of 24 VDC) | |
| Ambient operating temperature | | –10 to 55°C (with no icing) | |
| Ambient storage temperature | | –25 to 65°C (with no icing) | |
| Ambient operating humidity | | 25% to 85% (with no condensation; ambient operating temperature is 40°C max. at humidity of 85%) | |
| Insulation resistance | | 20 MΩ min. (at 500 VDC) between all terminals excluding the ground terminal and the case | |
| Dielectric strength | | 1,000 VAC (50/60 Hz) for 1 minute between all terminals excluding the ground terminal and the case | |
| Vibration resistance | | 10 to 150 Hz, 0.2-mm double amplitude at 15 m/s ² acceleration with 10 sweeps in X, Y and Z directions for 8 minutes each | |
| Shock resistance | | 150 m/s ² in X, Y, and Z directions 3 times each (18 times in total) | |
| Appearance | | 65 × 65 × 65 mm (excluding protrusions) | |
| Degree of protection | | IEC 60529, IP20 | |
| Materials | | Polycarbonate (PC) resin, ABS resin | |
| Weight | | Approx. 150 g | |
| Mounting | | DIN Track | |

Note: 1. For details, refer to the *User's Manual* (Cat. No. Z278).

2. The number of words allocated in the master depends on the Access Mode.

Amplifier-integrated Controllers (ID Flag Sensors)

| Item | Model | V680-HAM91 | V680-HAM81 |
|-------------------------------|-------|--|---|
| Rated voltage | | 24 VDC (–15% to +10%) including 10% ripple (p-p) | |
| Power consumption | | 3.5 W (24 VDC, 150 mA max. except external I/O line current) | |
| Input specifications | | Transistor output Short-circuit current: 3 mA (typical) (for short-circuit between IN terminal and 0 V), OFF voltage: 15 to 30 VDC, ON voltage: 0 to 5 VDC, Input impedance: 8.2 kΩ, Applied voltage: 30 VDC max. | |
| Output specifications | | NPN open-collector output 30 VDC, 20 mA max., Residual voltage: 2 V max. | PNP open-collector output 30 VDC, 20 mA max., Residual voltage: 2 V max. |
| Ambient operating temperature | | –10 to 55°C (with no icing) | |
| Ambient storage temperature | | –25 to 65°C (with no icing) | |
| Ambient operating humidity | | 25% to 85% (with no condensation; ambient operating temperature is 40°C max. at humidity of 85%) | |
| Insulation resistance | | 20 MΩ min. (at 500 VDC) between all terminals excluding the FG terminal and the case | |
| Dielectric strength | | 1,000 VAC (50/60 Hz) applied for 1 minute between all terminals excluding the FG terminal and the case | |
| Vibration resistance | | 10 to 150 Hz, 0.2-mm double amplitude at 15 m/s ² acceleration with 10 sweeps in X, Y and Z directions for 8 minutes each | |
| Shock resistance | | 150 m/s ² in X, Y, and Z directions 3 times each (18 times in total) | |
| Appearance | | 90 × 30 × 65 mm (excluding protrusions) | |
| Degree of protection | | IEC 60529, IP40 | |
| Materials | | Polycarbonate (PC) resin, ABS resin | |
| Weight | | Approx. 130 g | |
| Mounting | | DIN Track | |

Note: 1. For details, refer to the *User's Manual* (Cat. No. Z279).

2. The connectors are not water resistant. If there is a possibility that water will be splashed onto the ID Sensor Unit, mount it inside of a control box. Also, be sure to use the V680 as a set with the V680-A60 Interface Cable (sold separately).

V680 Series

Handheld Reader Writers

| Item | Model | V680-CHUD 0.8M | V680-CHUD 1.9M | V680-CH1D | V680-CH1D-PSI |
|--|--|---|--|---|-----------------------|
| Power supply voltage | 5 VDC \pm 5% (at the connector section of the product) | | | | |
| Current consumption | 500 mA max. (for a power supply voltage of 5.0 V) | | | | |
| Communications specifications | USB (Series A plug) Ver.1.1 | | RS-232C (D-SUB 9-pin) compatible with IBM PC/AT) | | RS-232C (D-SUB 9-pin) |
| Ambient operating temperature during communication | 0 to +40°C | | | | |
| Ambient storage temperature | -25 to +65°C | | | | |
| Ambient operating humidity during communication | 35% to 85% (with no condensation) | | | | |
| Insulation resistance | 50 M Ω min. (at 500 VDC) between connector and case | | | | |
| Dielectric strength | 1,000 VAC, 50/60 Hz for 1 min (leakage current: 1 mA max.) between connectors and case | | | | |
| Degree of protection | IEC 60529: IP63 * | | | | |
| Vibration resistance | Destruction: 10 to 150 Hz variable vibration, 0.2-mm double amplitude and 15 m/s ² acceleration with 10 sweeps for 8 min each in 6 directions | | | | |
| Shock resistance | Destruction: 150 m/s ² , 3 times each in X, Y, and Z directions | | | | |
| Weight | Approx. 110 g (including connector and cable) | Approx. 140 g (including connector and cable) | Approx. 170 g (including connector and cable) | Approx. 120 g (including connector and cable) | |
| Cable length | 0.8 m | 1.9 m | 2.5 m | 0.8 m | |

Note: Refer to the User's Manual (Cat. No. Z272) for details.

Contact your OMRON sales representative for details on drivers for Windows.













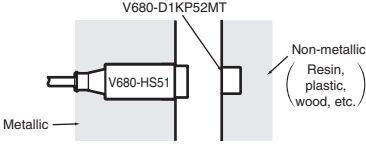

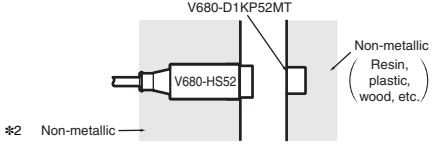

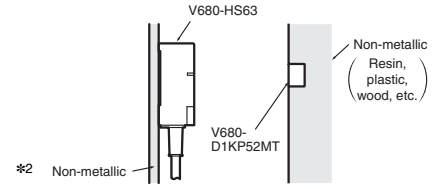

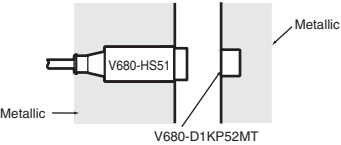
* This does not include the connector section. The main unit is not resistant to chemical or oils.

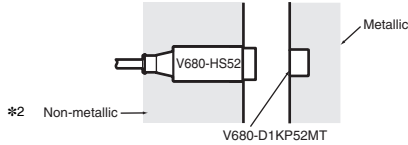
AC Adapter (for V680-CH1D)

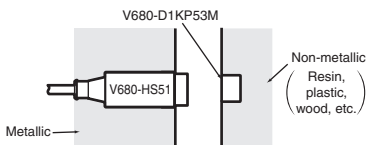
| Item | Model | V600-A22 |
|-------------------------------|--|----------|
| Input voltage | 100 to 120 VAC at 50/60 Hz | |
| Input current | AC: 300 mA (at load current of 2.0 A) | |
| Output voltage | DC5V \pm 0.25V | |
| Ambient operating temperature | 0 to +40°C | |
| Ambient storage temperature | -20 to +85°C (with no icing) | |
| Ambient operating humidity | 5% to 95% (with no condensation) | |
| Insulation resistance | 100 M Ω min. (at 500 VDC) between input terminals and output terminals | |
| Dielectric strength | 2,000 V for 1 minute between input terminals and output terminals with a current leakage of 10 mA max. | |
| Weight | Approx. 70 g | |
| Applicable standards | UL | |

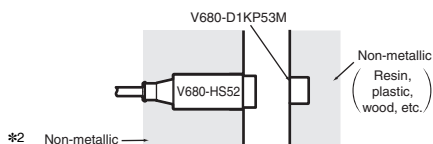
Communication Specifications

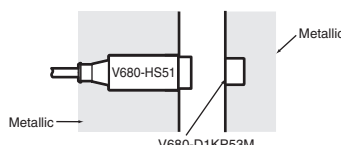

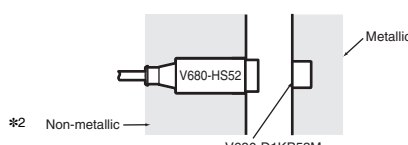









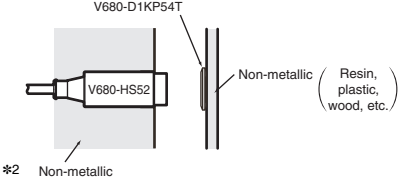

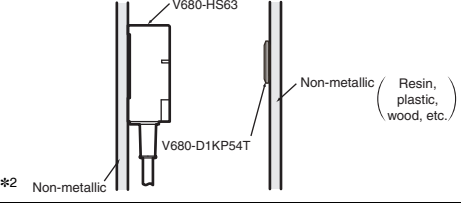
ID Controllers (V680-CA5D0□-V2, NX-V680C1/C2, CJ1W-V680C11/C12, CS1W-V680C11/C12) RF Tag (1-kbyte Memory) Communication

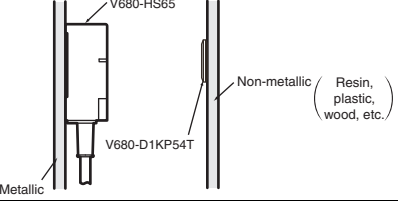
| Recommended combination | | Function | Communication range (unit: mm) | RF Tag and Antenna mounting conditions |
|--|---|----------------|--------------------------------|---|
| RF Tag | Antenna | | | |
|  | V680-HS51  | Read distance | 0.5 to 6.5 (axis offset ±2) |  |
| | | Write distance | 0.5 to 6.0 (axis offset ±2) | |
| | V680-HS52  | Read distance | 0 to 9.0 (axis offset ±2) |  |
| | | Write distance | 0 to 8.5 (axis offset ±2) | |
| | V680-HS63  | Read distance | 0 to 12.0 (axis offset ±2) |  |
| | | Write distance | 0 to 9.5 (axis offset ±2) | |
| V680-D1KP52MT (embedded in metallic surface: steel)  | V680-HS51  | Read distance | 0.5 to 3.5 *1 (axis offset ±2) |  |
| | | Write distance | 0.5 to 3.0 *1 (axis offset ±2) | |
| | V680-HS52  | Read distance | 0 to 4.5 *1 (axis offset ±2) |  |
| | | Write distance | 0 to 4.0 *1 (axis offset ±2) | |
| V680-D1KP53M  | V680-HS51  | Read distance | 0.5 to 6.5 (axis offset ±2) |  |
| | | Write distance | 0.5 to 6.0 (axis offset ±2) | |
| | V680-HS52  | Read distance | 0 to 9.0 (axis offset ±2) |  |
| | | Write distance | 0 to 8.5 (axis offset ±2) | |
| V680-D1KP53M (embedded in metallic surface : steel)  | V680-HS51  | Read distance | 0.5 to 3.5 *1 (axis offset ±2) |  |
| | | Write distance | 0.5 to 3.0 *1 (axis offset ±2) | |
| | V680-HS52  | Read distance | 0 to 4.5 *1 (axis offset ±2) |  |
| | | Write distance | 0 to 4.0 *1 (axis offset ±2) | |

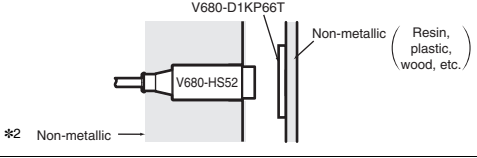
*1. When using the V680-D1KP52MT/-D1KP53M embedded in metal, use the V680-HS51/-HS52 Antenna. Communications will not be possible with a V680-HS63 Antenna.

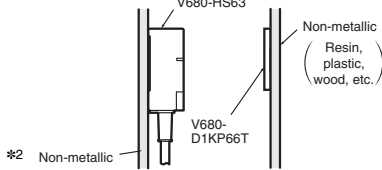
*2. The Antenna can be mounted in metal, but the communications distance will decrease compared to mounting in nonmetal. Confirm performance using the actual devices before actual operation.

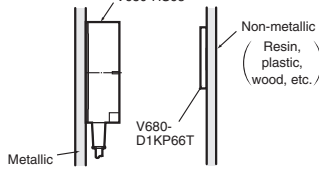
V680 Series

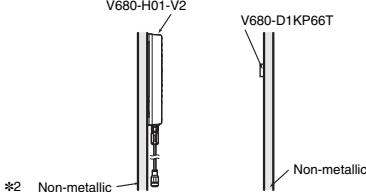
| Recommended combination | | Function | Communication range (unit: mm) | RF Tag and Antenna mounting conditions | |
|---|---|---|--------------------------------|--|--|
| RF Tag | Antenna | | | | |
|  | V680-HS52  | Read distance | 0 to 17.0 *1 (axis offset ±2) |  | |
| | | Write distance | 0 to 15.0 *1 (axis offset ±2) | | |
| | V680-HS63  | Read distance | 0 to 24.0 *1 (axis offset ±10) |  | |
| | | Write distance | 0 to 20.0 *1 (axis offset ±10) | | |
| | V680-HS65  | Read distance | 0 to 33.0 *1 (axis offset ±10) |  | |
| | | Write distance | 0 to 28.0 *1 (axis offset ±10) | | |
| |  | V680-HS52  | Read distance | 0 to 17.0 *1 (axis offset ±2) |  |
| | | | Write distance | 0 to 17.0 *1 (axis offset ±2) | |
| | | V680-HS63  | Read distance | 0 to 30.0 *1 (axis offset ±10) |  |
| Write distance | | | 0 to 25.0 *1 (axis offset ±10) | | |
| V680-HS65  | | Read distance | 0 to 47.0 *1 (axis offset ±10) |  | |
| | | Write distance | 0 to 42.0 *1 (axis offset ±10) | | |
| V680-H01-V2  | | Read distance | 0 to 100.0 *1 (axis offset ±2) |  | |
| | | Write distance | 0 to 100.0 *1 (axis offset ±2) | | |









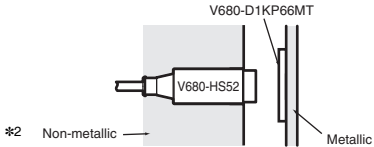

Note: When mounting the V680-HS65, be sure to attach the Mounting Brackets at the base of the Antenna.

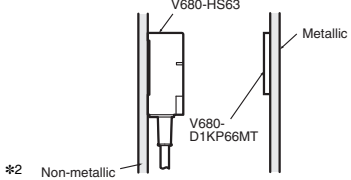
The enclosed Mounting Brackets do not need to be used, however, if the mounting brackets on the Antenna are metal plates and their dimensions are larger than the dimensions of the Antenna (100 × 100 mm).

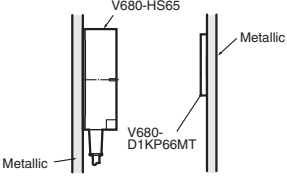
For details, refer to the User's Manual (Cat. No. Z248 or Z262).

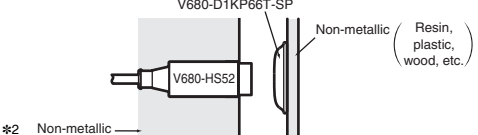
*1. The communication range may be reduced if the V680-D1KP66T/D1KP54T is mounted onto a metallic surface. Refer to the User's Manual (Cat. No. Z262) for details.

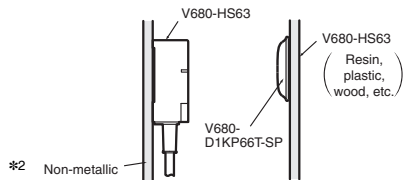

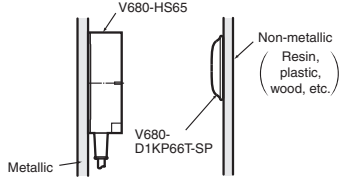
*2. The Antenna can be mounted in metal, but the communication range will decrease compared to mounting in nonmetal. Confirm performance using the actual devices before actual operation.

| Recommended combination | | Function | Communication range (unit: mm) | RF Tag and Antenna mounting conditions | |
|--|---|---|--------------------------------|--|---|
| RF Tag | Antenna | | | | |
| V680-D1KP66MT (flush-mounted on metallic surface: steel) | V680-HS52  | Read distance | 0 to 16.0 (axis offset ±2) |  | |
| | | Write distance | 0 to 14.0 (axis offset ±2) | | |
| |  | V680-HS63  | Read distance | 0 to 25.0 (axis offset ±10) |  |
| | | | Write distance | 0 to 20.0 (axis offset ±10) | |
| |  | V680-HS65  | Read distance | 0 to 25.0 (axis offset ±10) |  |
| | | | Write distance | 0 to 20.0 (axis offset ±10) | |
| V680-D1KP66T-SP | V680-HS52  | Read distance | 0 to 15.0 *1 (axis offset ±2) |  | |
| | | Write distance | 0 to 15.0 *1 (axis offset ±2) | | |
| |  | V680-HS63  | Read distance | 0 to 25.0 *1 (axis offset ±10) |  |
| | | | Write distance | 0 to 20.0 *1 (axis offset ±10) | |
| |  | V680-HS65  | Read distance | 0 to 42.0 *1 (axis offset ±10) |  |
| | | | Write distance | 0 to 37.0 *1 (axis offset ±10) | |

Note: When mounting the V680-HS65, be sure to attach the Mounting Brackets at the base of the Antenna.
 The enclosed Mounting Brackets do not need to be used, however, if the mounting brackets on the Antenna are metal plates and their dimensions are larger than the dimensions of the Antenna (100 × 100 mm).
 For details, refer to the User's Manual (Cat. No. Z248 or Z262).



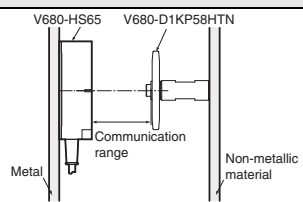

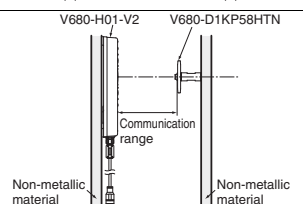







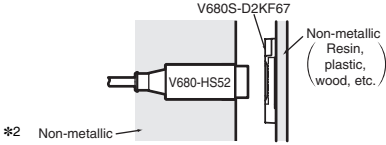

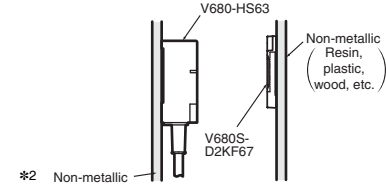
- *1. The communication range may be reduced if the V680-D1KP66T-SP is mounted onto a metallic surface. Refer to the User's Manual (Cat. No. Z262) for details.
- *2. The Antenna can be mounted in metal, but the communications distance will decrease compared to mounting in nonmetal.
 Confirm performance using the actual devices before actual operation.

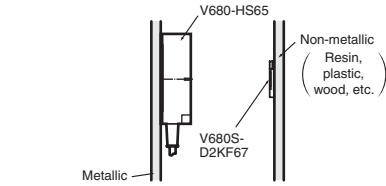
High-temperature RF Tag (1-kbyte Memory) Communication

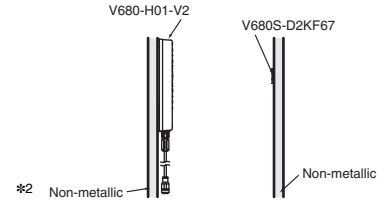
| Recommended combination | | Function | Communication range (unit: mm) | RF Tag and Antenna mounting conditions | |
|-------------------------|---|---|--------------------------------|---|---|
| RF Tag | Antenna | | | | |
| V680-D1KP58HTN | V680-HS65  | Read distance | 0 to 55 (axis offset ±10) |  | |
| | | Write distance | 0 to 55 (axis offset ±10) | | |
| |  | V680-H01-V2  | Read distance | 0 to 150.0 (axis offset ±10) |  |
| | | | Write distance | 0 to 150.0 (axis offset ±10) | |

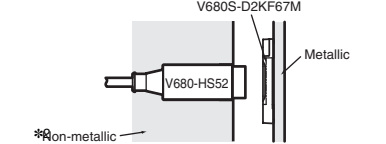
V680 Series

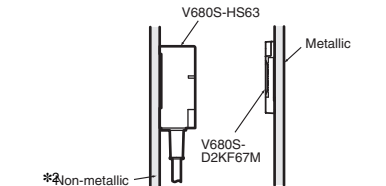
RF Tag (2-kbyte Memory) Communication

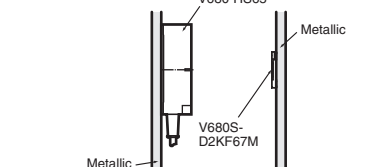
| Recommended combination | | Function | Communication range (unit: mm) | RF Tag and Antenna mounting conditions |
|---|---|---------------------------------|---|---|
| RF Tag | Antenna | | | |
|  V680S-D2KF67 |  V680-HS52 | Read distance | 0 to 17.0 *1 (axis offset ±2) |  *2 Non-metallic |
| | | Write distance | 0 to 17.0 *1 (axis offset ±2) | |
| |  V680-HS63 | Read distance | 7.0 to 30.0 *1 (axis offset ±10) |  *2 Non-metallic |
| | | Write distance | 7.0 to 30.0 *1 (axis offset ±10) | |
|  V680-HS65 | Read distance | 0 to 42.0 *1 (axis offset ±10) |  *2 Non-metallic | |
| | Write distance | 0 to 42.0 *1 (axis offset ±10) | | |
|  V680-H01-V2 | Read distance | 0 to 100.0 *1 (axis offset ±10) |  *2 Non-metallic | |
| | Write distance | 0 to 100.0 *1 (axis offset ±10) | | |
|  V680S-D2KF67M (flush-mounted on metallic surface: steel) |  V680-HS52 | Read distance | 0 to 16.0 (axis offset ±2) |  *2 Non-metallic |
| | | Write distance | 0 to 16.0 (axis offset ±2) | |
| |  V680-HS63 | Read distance | 6.0 to 25.0 (axis offset ±10) |  *2 Non-metallic |
| Write distance | | 6.0 to 25.0 (axis offset ±10) | | |
|  V680-HS65 | Read distance | 0 to 25.0 (axis offset ±10) |  *2 Non-metallic | |
| | Write distance | 0 to 25.0 (axis offset ±10) | | |













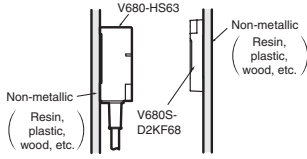

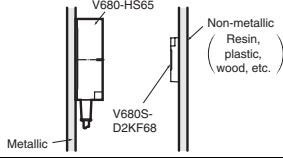

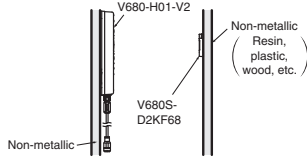

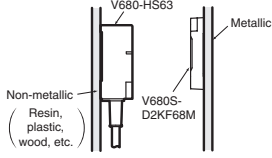

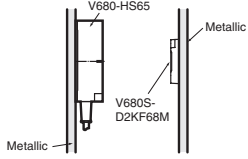
Note: When mounting the V680-HS65, be sure to attach the Mounting Brackets at the base of the Antenna.

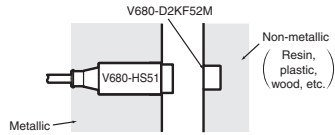
The enclosed Mounting Brackets do not need to be used, however, if the mounting brackets on the Antenna are metal plates and their dimensions are larger than the dimensions of the Antenna (100 × 100 mm).

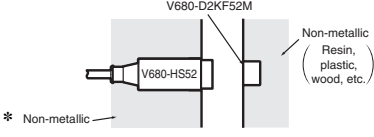
For details, refer to the User's Manual (Cat. No. Z248 or Z262).

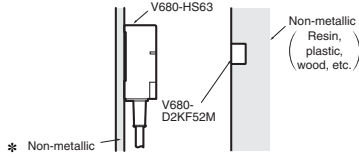
*1. The communication range may be reduced if the V680S-D2KF67 is mounted onto a metallic surface. Refer to the User's Manual (Cat. No. Z248) for details.

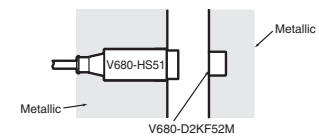
*2. The Antenna can be mounted in metal, but the communications distance will decrease compared to mounting in nonmetal. Confirm performance using the actual devices before actual operation.

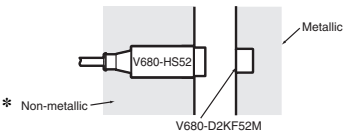











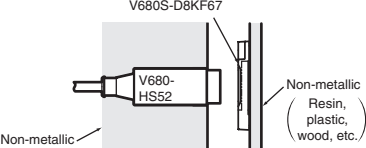

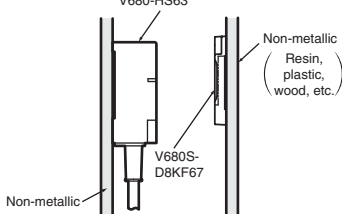
| Recommended combination | | Function | Communication range (unit: mm) | RF Tag and Antenna mounting conditions |
|---|---|----------------|--------------------------------|---|
| RF Tag | Antenna | | | |
|  | V680-HS63  | Read distance | 0 to 45.0 (axis offset ±10) |  |
| | | Write distance | 0 to 45.0 (axis offset ±10) | |
| | V680-HS65  | Read distance | 0 to 75.0 (axis offset ±10) |  |
| | | Write distance | 0 to 75.0 (axis offset ±10) | |
| | V680-H01-V2  | Read distance | 0 to 150.0 (axis offset ±10) |  |
| | | Write distance | 0 to 150.0 (axis offset ±10) | |
| V680S-D2KF68M  | V680-HS63  | Read distance | 0 to 35.0 (axis offset ±10) |  |
| | | Write distance | 0 to 35.0 (axis offset ±10) | |
| | V680-HS65  | Read distance | 0 to 55.0 (axis offset ±10) |  |
| | | Write distance | 0 to 55.0 (axis offset ±10) | |
| V680-D2KF52M  | V680-HS51  | Read distance | 0.5 to 5.5 (axis offset ±2) |  |
| | | Write distance | 0.5 to 5.5 (axis offset ±2) | |
| | V680-HS52  | Read distance | 0 to 8.0 (axis offset ±2) |  |
| | | Write distance | 0 to 8.0 (axis offset ±2) | |
| | V680-HS63  | Read distance | 0 to 9.5 (axis offset ±2) |  |
| | | Write distance | 0 to 9.5 (axis offset ±2) | |
| V680-D2KF52M (embedded in metallic surface: steel)  | V680-HS51  | Read distance | 0 to 3.5 (axis offset ±2) |  |
| | | Write distance | 0 to 3.5 (axis offset ±2) | |
| | V680-HS52  | Read distance | 0 to 3.0 (axis offset ±2) |  |
| | | Write distance | 0 to 3.0 (axis offset ±2) | |

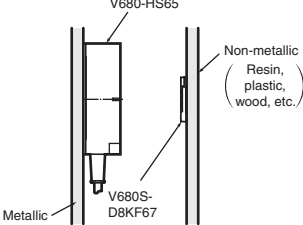
Note: When mounting the V680-HS65, be sure to attach the Mounting Brackets at the base of the Antenna. The enclosed Mounting Brackets do not need to be used, however, if the mounting brackets on the Antenna are metal plates and their dimensions are larger than the dimensions of the Antenna (100 × 100 mm). For details, refer to the User's Manual (Cat. No. Z248 or Z262).

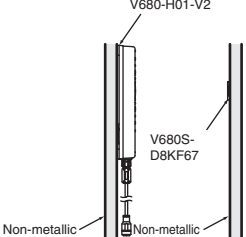
* The Antenna can be mounted in metal, but the communications distance will decrease compared to mounting in nonmetal. Confirm performance using the actual devices before actual operation.

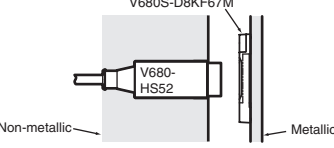

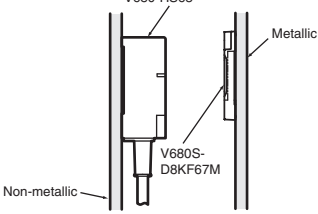

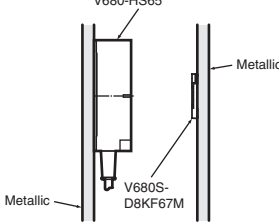



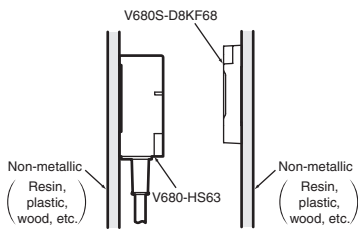

V680 Series

RF Tag (8-kbyte Memory) Communication

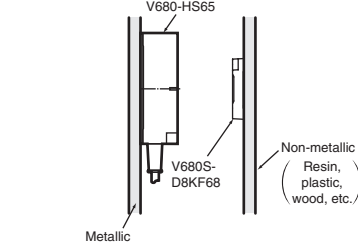
| Recommended combination | | Function | Communication range (unit: mm) | RF Tag and Antenna mounting conditions |
|---|---|-----------------------------|--------------------------------|---|
| RF Tag | Reader Writer | | | |
|  | V680-HS52  | Read distance | 0 to 17.0 (axis offset ±2) |  |
| | | Write distance | 0 to 17.0 (axis offset ±2) | |
| | V680-HS63  | Read distance | 7.0 to 30.0 (axis offset ±10) |  |
| | | Write distance | 7.0 to 30.0 (axis offset ±10) | |
| | V680-HS65  | Read distance | 0 to 42.0 (axis offset ±10) |  |
| | Write distance | 0 to 42.0 (axis offset ±10) | | |
| | V680-H01-V2  | Read distance | 0 to 100.0 (axis offset ±10) |  |
| | | Write distance | 0 to 100.0 (axis offset ±10) | |
|  | V680-HS52  | Read distance | 0 to 16.0 (axis offset ±2) |  |
| | | Write distance | 0 to 16.0 (axis offset ±2) | |
| | V680-HS63  | Read distance | 6.0 to 25.0 (axis offset ±10) |  |
| | | Write distance | 6.0 to 25.0 (axis offset ±10) | |
| | V680-HS65  | Read distance | 0 to 25.0 (axis offset ±10) |  |
| | | Write distance | 0 to 25.0 (axis offset ±10) | |

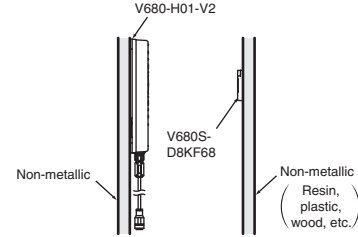
Note: When mounting the V680-HS65, be sure to attach the Mounting Brackets at the base of the Antenna.

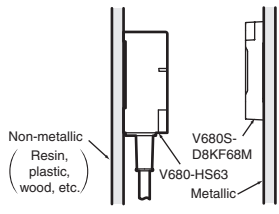

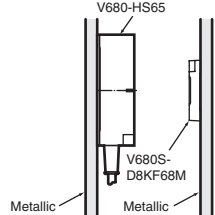





The enclosed Mounting Brackets do not need to be used, however, if the mounting brackets on the Antenna are metal plates and their dimensions are larger than the dimensions of the Antenna (100 × 100 mm). For details, refer to the User's Manual (Cat. No. Z248 or Z262).

| Recommended combination | | Function | Communication range (unit: mm) | RF Tag and Antenna mounting conditions |
|---|---|----------------|--------------------------------|---|
| RF Tag | Reader Writer | | | |
|  | V680-HS63  | Read distance | 0 to 45.0 (axis offset ±10) |  |
| | | Write distance | 0 to 45.0 (axis offset ±10) | |
| | V680-HS65  | Read distance | 0 to 75.0 (axis offset ±10) |  |
| | | Write distance | 0 to 75.0 (axis offset ±10) | |
| | V680-H01-V2  | Read distance | 0 to 150.0 (axis offset ±10) |  |
| | | Write distance | 0 to 150.0 (axis offset ±10) | |
| V680S-D8KF68M  | V680-HS63  | Read distance | 0 to 35.0 (axis offset ±10) |  |
| | | Write distance | 0 to 35.0 (axis offset ±10) | |
| | V680-HS65  | Read distance | 0 to 55.0 (axis offset ±10) |  |
| | | Write distance | 0 to 55.0 (axis offset ±10) | |

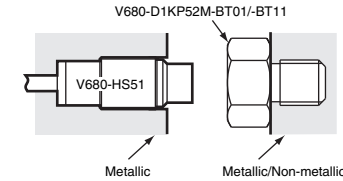
Note: When mounting the V680-HS65, be sure to attach the Mounting Brackets at the base of the Antenna.
 The enclosed Mounting Brackets do not need to be used, however, if the mounting brackets on the Antenna are metal plates and their dimensions are larger than the dimensions of the Antenna (100 × 100 mm).
 For details, refer to the User's Manual (Cat. No. Z248 or Z262).

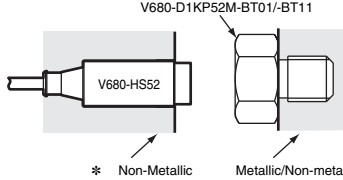

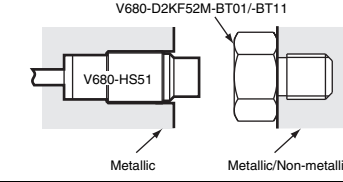

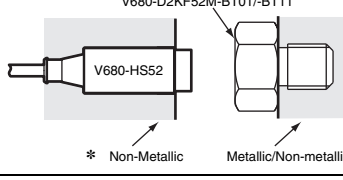







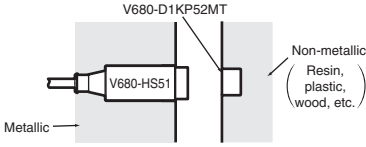

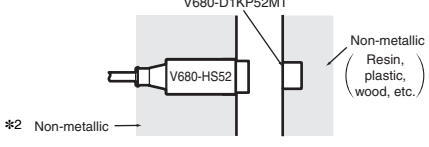

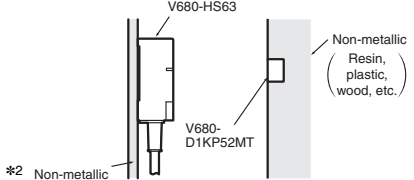

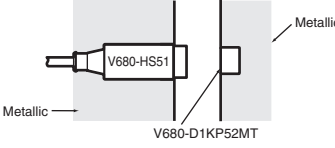
V680 Series

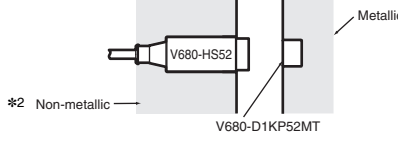
Bolt RF Tag (1-kbyte or 2-kbyte Memory) Communication

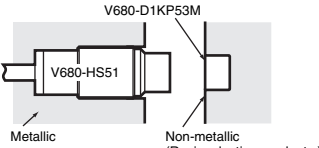

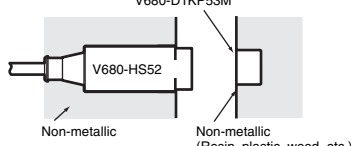

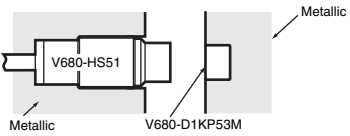
| Recommended combination | | Function | Communication range (unit: mm) | RF Tag and Antenna mounting conditions |
|---|--|----------------|--------------------------------|--|
| RF Tag | Antenna | | | |
| V680-D1KP52M-BT01/-BT11  | V680-HS51  | Read distance | 0.5 to 2.5 (axis offset ±2) |  |
| | | Write distance | 0.5 to 2.0 (axis offset ±2) | |
|  | V680-HS52  | Read distance | 0.5 to 3.0 (axis offset ±2) |  |
| | | Write distance | 0.5 to 2.5 (axis offset ±2) | |
| V680-D2KF52M-BT01/-BT11  | V680-HS51  | Read distance | 0.5 to 2.5 (axis offset ±2) |  |
| | | Write distance | 0.5 to 2.5 (axis offset ±2) | |
|  | V680-HS52  | Read distance | 0.5 to 2.0 (axis offset ±2) |  |
| | | Write distance | 0.5 to 2.0 (axis offset ±2) | |

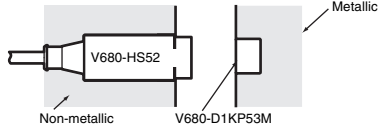
* Mounting can be performed in metal, but the communications distance will decrease compared to mounting in nonmetal. Confirm performance using the actual devices before actual operation.

**DeviceNet ID Slave (V680-HAM42-DRT)
 PROFIBUS ID Slave (V680-HAM42-PRT)
 ID Flag Sensors (V680-HAM91/-HAM81)
 RF Tag (1-kbyte Memory) Communication**

| Recommended combination | | Function | Communication range (unit: mm) | RF Tag and Antenna mounting conditions |
|--|---|----------------|--------------------------------|---|
| RF Tag | Antenna | | | |
| V680-D1KP52MT  | V680-HS51  | Read distance | 0.5 to 6.5 (axis offset ±2) |  |
| | | Write distance | 0.5 to 6.0 (axis offset ±2) | |
| | V680-HS52  | Read distance | 0.5 to 9.0 (axis offset ±2) |  |
| | | Write distance | 0.5 to 8.5 (axis offset ±2) | |
| | V680-HS63  | Read distance | 0.5 to 12.0 (axis offset ±2) |  |
| | | Write distance | 0.5 to 9.5 (axis offset ±2) | |
| V680-D1KP52MT (embedded in metallic surface: steel)  | V680-HS51  | Read distance | 0.5 to 3.5 (axis offset ±2) |  |
| | | Write distance | 0.5 to 3.0 (axis offset ±2) | |
| | V680-HS52  | Read distance | 0.5 to 4.5 (axis offset ±2) |  |
| | | Write distance | 0.5 to 4.0 (axis offset ±2) | |
| V680-D1KP53M  | V680-HS51  | Read distance | 0.5 to 6.5 (axis offset ±2) |  |
| | | Write distance | 0.5 to 6.0 (axis offset ±2) | |
| | V680-HS52  | Read distance | 0.5 to 9.0 (axis offset ±2) |  |
| | | Write distance | 0.5 to 8.5 (axis offset ±2) | |
| V680-D1KP53M (embedded in metallic surface : steel)  | V680-HS51  | Read distance | 0.5 to 3.5 (axis offset ±2) |  |
| | | Write distance | 0.5 to 3.0 (axis offset ±2) | |
| | V680-HS52  | Read distance | 0.5 to 4.5 (axis offset ±2) |  |
| | | Write distance | 0.5 to 4.0 (axis offset ±2) | |

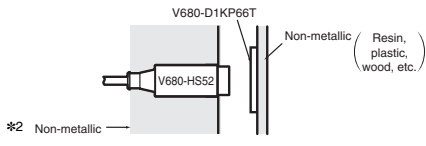
V680 Series

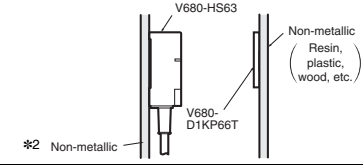
| Recommended combination | | Function | Communication range (unit: mm) | RF Tag and Antenna mounting conditions |
|--|---|----------------|----------------------------------|--|
| RF Tag | Antenna | | | |
| V680-D1KP66T  | V680-HS52  | Read distance | 1.0 to 17.0 *1 (axis offset ±2) |  |
| | | Write distance | 1.0 to 17.0 *1 (axis offset ±2) | |
| | V680-HS63  | Read distance | 5.0 to 30.0 *1 (axis offset ±10) | |
| | | Write distance | 5.0 to 25.0 *1 (axis offset ±10) | |
| | V680-HS65  | Read distance | 5.0 to 47.0 *1 (axis offset ±10) | |
| | | Write distance | 5.0 to 42.0 *1 (axis offset ±10) | |









Note: When mounting the V680-HS65, be sure to attach the Mounting Brackets at the base of the Antenna.

The enclosed Mounting Brackets do not need to be used, however, if the mounting brackets on the Antenna are metal plates and their dimensions are larger than the dimensions of the Antenna (100 × 100 mm).

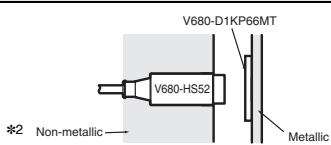
For details, refer to the User's Manual (Cat. No. Z278 or Z279).

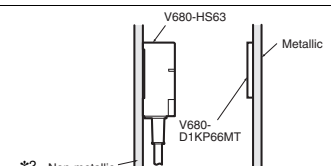
*1. The communication range may be reduced if the V680-D1KP66T is mounted onto a metallic surface. Refer to the User's Manual (Cat. No. Z278 or Z279) for details.

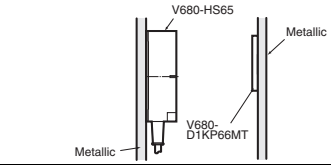
*2. The Antenna can be mounted in metal, but the communications distance will decrease compared to mounting in nonmetal.

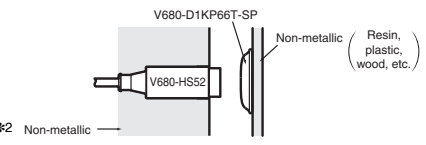
| Recommended combination | | Function | Communication range (unit: mm) | RF Tag and Antenna mounting conditions |
|---|---|----------------|----------------------------------|--|
| RF Tag | Antenna | | | |
| V680-D1KP66MT (flush-mounted on metallic surface: steel)  | V680-HS52  | Read distance | 1.0 to 16.0 (axis offset ±2) |  |
| | | Write distance | 1.0 to 14.0 (axis offset ±2) | |
| | V680-HS63  | Read distance | 5.0 to 25.0 (axis offset ±2) | |
| | | Write distance | 5.0 to 20.0 (axis offset ±2) | |
| | V680-HS65  | Read distance | 5.0 to 25.0 (axis offset ±10) | |
| | | Write distance | 5.0 to 20.0 (axis offset ±10) | |
| V680-D1KP66T-SP  | V680-HS52  | Read distance | 1.0 to 15.0 *1 (axis offset ±2) |  |
| | | Write distance | 1.0 to 15.0 *1 (axis offset ±2) | |
| | V680-HS63  | Read distance | 5.0 to 25.0 *1 (axis offset ±10) | |
| | | Write distance | 5.0 to 20.0 *1 (axis offset ±10) | |
| | V680-HS65  | Read distance | 5.0 to 42.0 *1 (axis offset ±10) | |
| | | Write distance | 5.0 to 37.0 *1 (axis offset ±10) | |

Note: When mounting the V680-HS65, be sure to attach the Mounting Brackets at the base of the Antenna.

The enclosed Mounting Brackets do not need to be used, however, if the mounting brackets on the Antenna are metal plates and their dimensions are larger than the dimensions of the Antenna (100 × 100 mm).













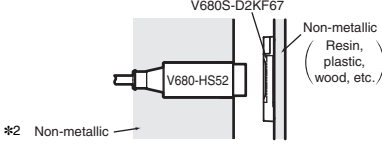

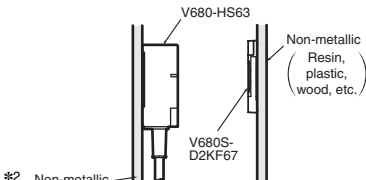

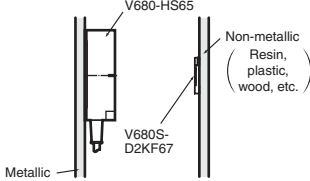
For details, refer to the User's Manual (Cat. No. Z278 or Z279).

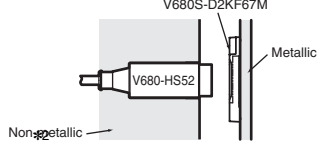
*1. The communication range may be reduced if the V680-D1KP66T-SP is mounted onto a metallic surface. Refer to the User's Manual (Cat. No. Z278 or Z279) for details.

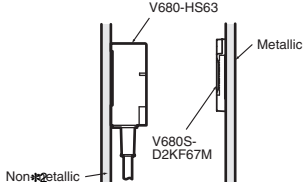
*2. The Antenna can be mounted in metal, but the communications distance will decrease compared to mounting in nonmetal.

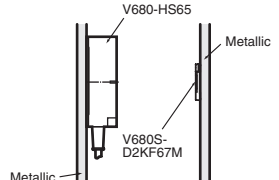
Confirm performance using the actual devices before actual operation.

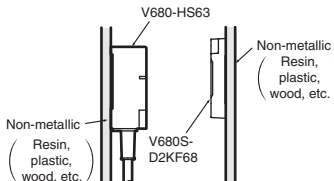

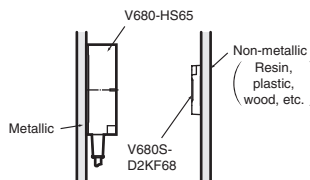









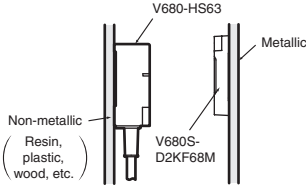

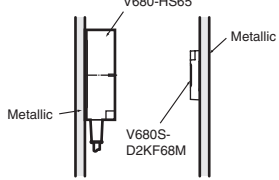
RF Tag (2-kbyte Memory) Communication

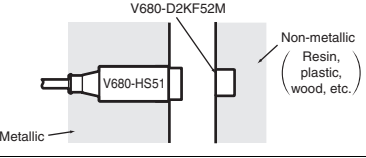
| Recommended combination | | Function | Communication range (unit: mm) | RF Tag and Antenna mounting conditions |
|--|---|----------------|----------------------------------|---|
| RF Tag | Antenna | | | |
| V680S-D2KF67  | V680-HS52  | Read distance | 1.0 to 17.0 *1 (axis offset ±2) |  |
| | | Write distance | 1.0 to 17.0 *1 (axis offset ±2) | |
| | V680-HS63  | Read distance | 7.0 to 30.0 *1 (axis offset ±10) |  |
| | | Write distance | 7.0 to 30.0 *1 (axis offset ±10) | |
| | V680-HS65  | Read distance | 5.0 to 42.0 *1 (axis offset ±10) |  |
| | | Write distance | 5.0 to 42.0 *1 (axis offset ±10) | |
| V680S-D2KF67M (flush-mounted on metallic surface: steel) | V680-HS52  | Read distance | 1.0 to 16.0 (axis offset ±2) |  |
| | | Write distance | 1.0 to 16.0 (axis offset ±2) | |
| | V680-HS63  | Read distance | 6.0 to 25.0 (axis offset ±10) |  |
| | | Write distance | 6.0 to 25.0 (axis offset ±10) | |
| | V680-HS65  | Read distance | 5.0 to 25.0 (axis offset ±10) |  |
| | | Write distance | 5.0 to 25.0 (axis offset ±10) | |
| V680S-D2KF68  | V680-HS63  | Read distance | 5.0 to 45.0 (axis offset ±10) |  |
| | | Write distance | 5.0 to 45.0 (axis offset ±10) | |
| | V680-HS65  | Read distance | 5.0 to 75.0 (axis offset ±10) |  |
| | | Write distance | 5.0 to 75.0 (axis offset ±10) | |

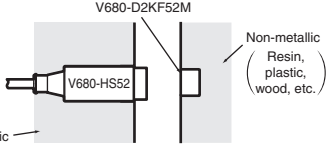
Note: When mounting the V680-HS65, be sure to attach the Mounting Brackets at the base of the Antenna.
 The enclosed Mounting Brackets do not need to be used, however, if the mounting brackets on the Antenna are metal plates and their dimensions are larger than the dimensions of the Antenna (100 × 100 mm).
 For details, refer to the User's Manual (Cat. No. Z278 or Z279).

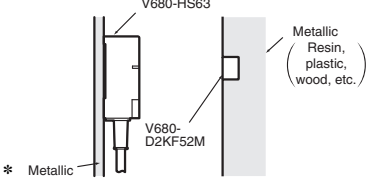

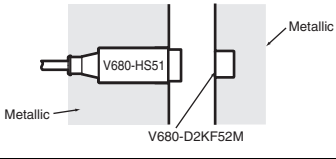

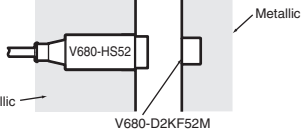







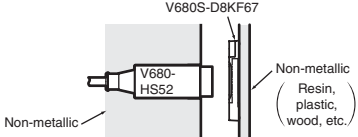

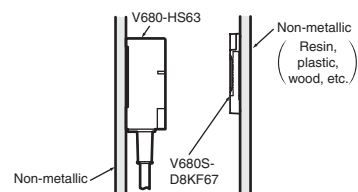

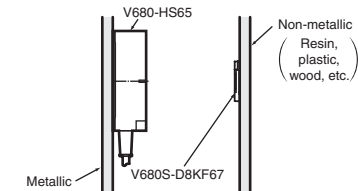
*1. The communication range may be reduced if the V680S-D2KF67 is mounted onto a metallic surface. Refer to the User's Manual (Cat. No. Z278 or Z279) for details.
 *2. The Antenna can be mounted in metal, but the communications distance will decrease compared to mounting in nonmetal.
 Confirm performance using the actual devices before actual operation.

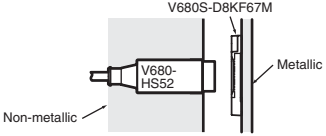
V680 Series

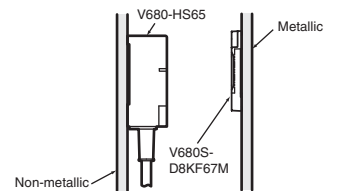

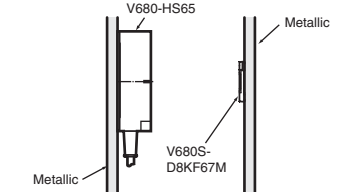

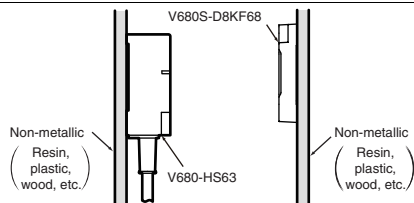
| Recommended combination | | Function | Communication range (unit: mm) | RF Tag and Antenna mounting conditions |
|--|--|--|--|---|
| RF Tag | Antenna | | | |
| V680S-D2KF68M  | V680-HS63  | Read distance | 5.0 to 35.0 (axis offset ± 10) |  |
| | Write distance | 5.0 to 35.0 (axis offset ± 10) | | |
| | V680-HS65  | Read distance | 5.0 to 55.0 (axis offset ± 10) |  |
| | Write distance | 5.0 to 55.0 (axis offset ± 10) | | |
| V680-D2KF52M  | V680-HS51  | Read distance | 0.5 to 5.5 (axis offset ± 2) |  |
| | Write distance | 0.5 to 5.5 (axis offset ± 2) | | |
| | V680-HS52  | Read distance | 0.5 to 8.0 (axis offset ± 2) |  |
| Write distance | 0.5 to 8.0 (axis offset ± 2) | | | |
| | V680-HS63  | Read distance | 0.5 to 9.5 (axis offset ± 2) |  |
| | Write distance | 0.5 to 9.5 (axis offset ± 2) | | |
| V680-D2KF52M (embedded in metallic surface: steel)  | V680-HS51  | Read distance | 0.5 to 3.5 (axis offset ± 2) |  |
| | Write distance | 0.5 to 3.5 (axis offset ± 2) | | |
| | V680-HS52  | Read distance | 0.5 to 3.0 (axis offset ± 2) |  |
| | Write distance | 0.5 to 3.0 (axis offset ± 2) | | |

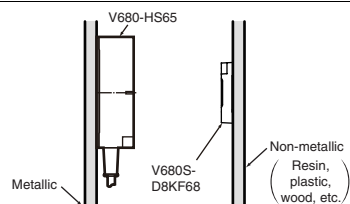
* The Antenna can be mounted in metal, but the communications distance will decrease compared to mounting in nonmetal.
Confirm performance using the actual devices before actual operation.

RF Tag (8-kbyte Memory) Communication



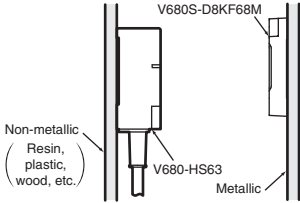

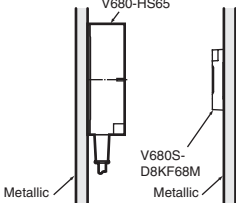



| Recommended combination | | Function | Communication range (unit: mm) | RF Tag and Antenna mounting conditions |
|--|---|----------------|--------------------------------|---|
| RF Tag | Reader Writer | | | |
| V680S-D8KF67  | V680-HS52  | Read distance | 1.0 to 17.0 (axis offset ±2) |  |
| | | Write distance | 1.0 to 17.0 (axis offset ±2) | |
| | V680-HS63  | Read distance | 7.0 to 30.0 (axis offset ±10) |  |
| | | Write distance | 7.0 to 30.0 (axis offset ±10) | |
| | V680-HS65  | Read distance | 5.0 to 42.0 (axis offset ±10) |  |
| | | Write distance | 5.0 to 42.0 (axis offset ±10) | |
| V680S-D8KF67M (flush-mounted on metallic surface: steel) | V680-HS52  | Read distance | 1.0 to 16.0 (axis offset ±2) |  |
| | | Write distance | 1.0 to 16.0 (axis offset ±2) | |
| | V680-HS63  | Read distance | 6.0 to 25.0 (axis offset ±10) |  |
| | | Write distance | 6.0 to 25.0 (axis offset ±10) | |
| | V680-HS65  | Read distance | 5.0 to 25.0 (axis offset ±10) |  |
| | | Write distance | 5.0 to 25.0 (axis offset ±10) | |
| V680S-D8KF68  | V680-HS63  | Read distance | 5.0 to 45.0 (axis offset ±10) |  |
| | | Write distance | 5.0 to 45.0 (axis offset ±10) | |
| | V680-HS65  | Read distance | 5.0 to 75.0 (axis offset ±10) |  |
| | | Write distance | 5.0 to 75.0 (axis offset ±10) | |

V680 Series

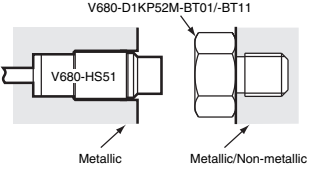
| Recommended combination | | Function | Communication range (unit: mm) | RF Tag and Antenna mounting conditions |
|---|---|----------------|--------------------------------|---|
| RF Tag | Reader Writer | | | |
|  |  | Read distance | 5.0 to 35.0 (axis offset ±10) |  |
| | | Write distance | 5.0 to 35.0 (axis offset ±10) | |
| |  | Read distance | 5.0 to 55.0 (axis offset ±10) |  |
| | | Write distance | 5.0 to 55.0 (axis offset ±10) | |

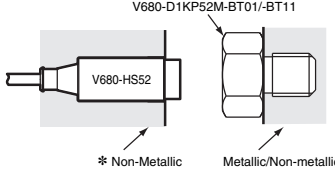
Note: When mounting the V680-HS65, be sure to attach the Mounting Brackets at the base of the Antenna. The enclosed Mounting Brackets do not need to be used, however, if the mounting brackets on the Antenna are metal plates and their dimensions are larger than the dimensions of the Antenna (100 × 100 mm). For details, refer to the User's Manual (Cat. No. Z248 or Z262).

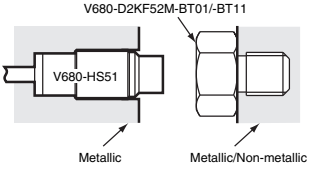
Bolt RF Tag (1-kbyte or 2-kbyte Memory) Communication

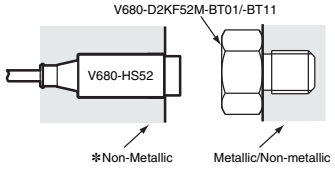
| Recommended combination | | Function | Communication range (unit: mm) | RF Tag and Antenna mounting conditions |
|---|---|----------------|--------------------------------|---|
| RF Tag | Antenna | | | |
|  |  | Read distance | 0.5 to 2.5 (axis offset ±2) |  |
| | | Write distance | 0.5 to 2.0 (axis offset ±2) | |
|  |  | Read distance | 0.5 to 3.0 (axis offset ±2) |  |
| | | Write distance | 0.5 to 2.5 (axis offset ±2) | |
|  |  | Read distance | 0.5 to 2.5 (axis offset ±2) |  |
| | | Write distance | 0.5 to 2.5 (axis offset ±2) | |
|  |  | Read distance | 0.5 to 2.0 (axis offset ±2) |  |
| | | Write distance | 0.5 to 2.0 (axis offset ±2) | |

* Mounting can be performed in metal, but the communications distance will decrease compared to mounting in nonmetal. Confirm performance using the actual devices before actual operation.

Characteristic Data (for Reference Only)

Communication range (for Reference Only)

(unit: mm)

ID Controller (using the V680-CA5D0□-V2, NX-V680C1/C2, CJ1W-V680C11/C12, or CS1W-V680C11/C12)

1-kbyte Memory RF Tag

The values given for communications ranges are reference values. Refer to pages 17 to 19, 24 for communications distance specifications. The communications distance will depend on the RF Tags, ambient temperature, surrounding metal, noise, and other factors. Test operation completely when installing a system.

V680-HS52 (embedded in non-metallic material) & V680-D1KP52MT (embedded in non-metallic material)

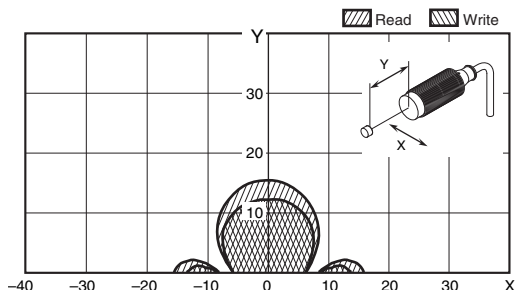

V680-HS51 (embedded in metallic material) & V680-D1KP52MT (embedded in non-metallic material)

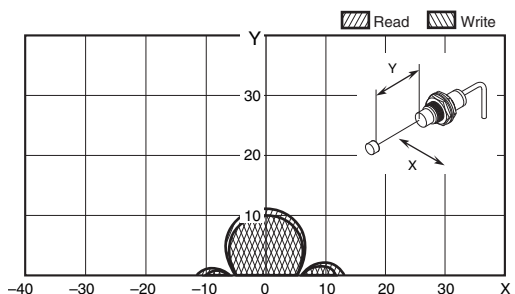

V680-HS63 (mounted on non-metallic material) & V680-D1KP52MT (embedded in non-metallic material)

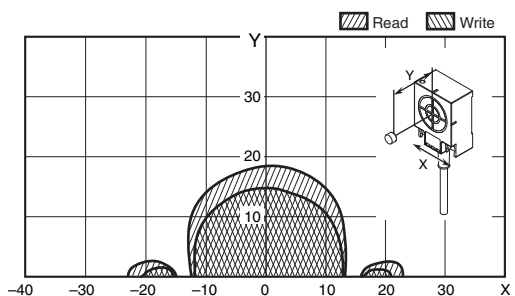

V680-HS51 (embedded in metallic material) & V680-D1KP53M (embedded in non-metallic material)

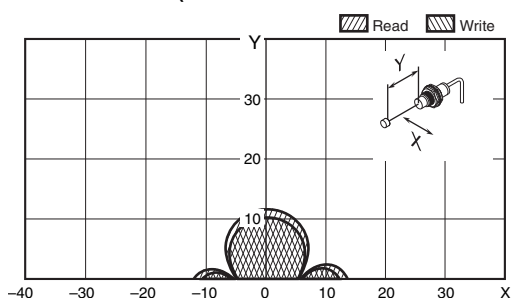

V680-HS52 (embedded in non-metallic material) & V680-D1KP53M (embedded in non-metallic material)

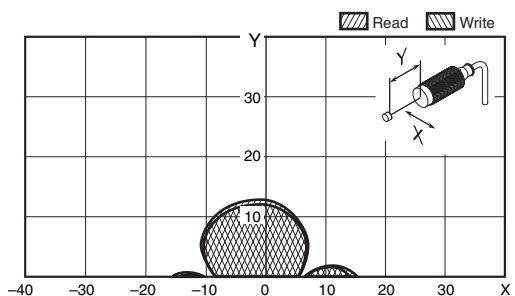

V680-HS52 (embedded in non-metallic material) & V680-D1KP52MT (embedded in metallic surface: steel)

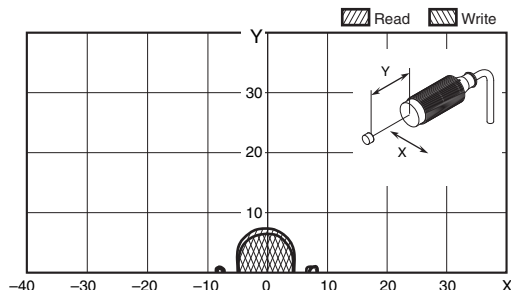

V680-HS51 (embedded in metallic material) & V680-D1KP52MT (embedded in metallic surface: steel)

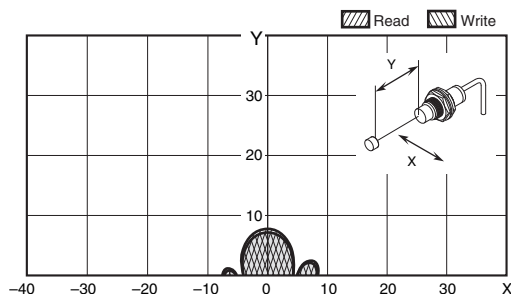

V680-HS51 (embedded in metallic material) & V680-D1KP53M (embedded in metallic surface: steel)

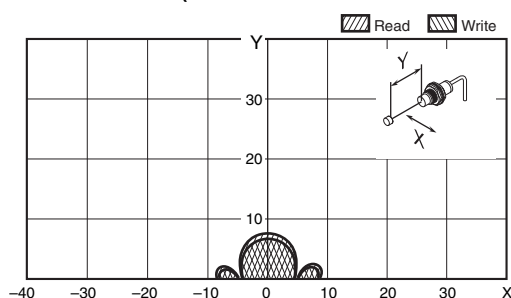

V680-HS52 (embedded in non-metallic material) & V680-D1KP53M (embedded in metallic surface: steel)

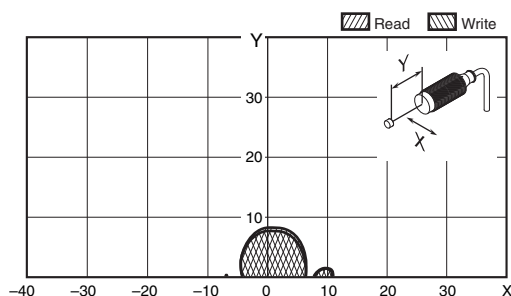

V680 Series

V680-HS52 (embedded in non-metallic material) & V680-D1KP54T (mounted on non-metallic material)

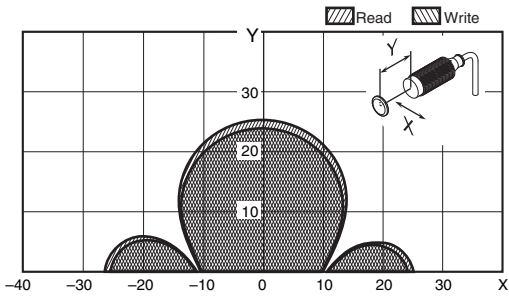

V680-HS63 (mounted on non-metallic material) & V680-D1KP54T (mounted on non-metallic material)

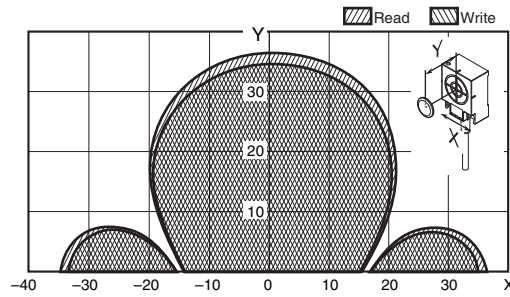

V680-HS65 (mounted on metallic material) & V680-D1KP54T (mounted on non-metallic material)

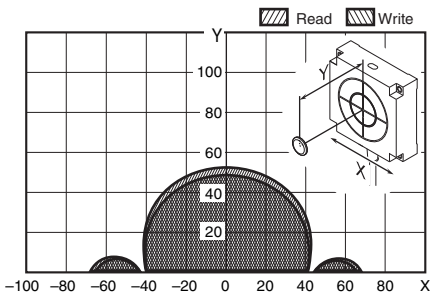

V680-HS63 (mounted on non-metallic material) & V680-D1KP66T (mounted on non-metallic material)

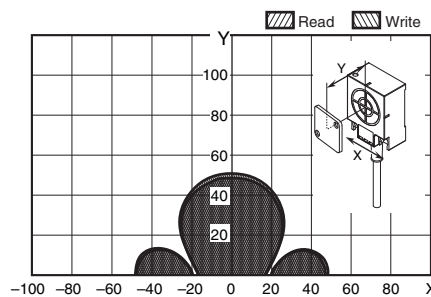

V680-HS52 (embedded in non-metallic material) & V680-D1KP66T (mounted on non-metallic material)

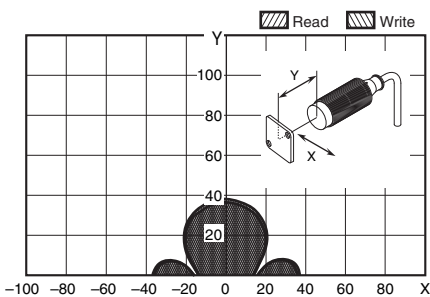

V680-HS65 (mounted on metallic material) & V680-D1KP66T (mounted on non-metallic material)

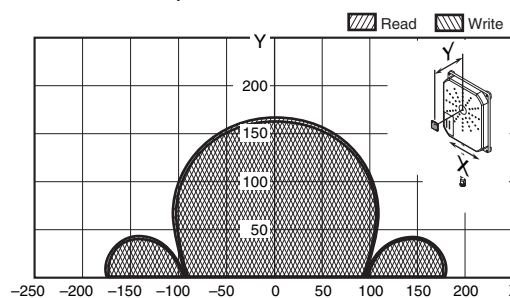

V680-HS52 (mounted on metallic material) & V680-D1KP66T (mounted on non-metallic material)

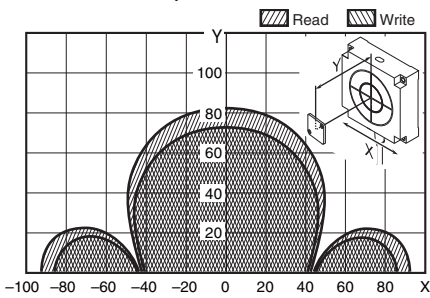

V680-HS63 (mounted on non-metallic material) & V680-D1KP66T-SP (mounted on non-metallic material)

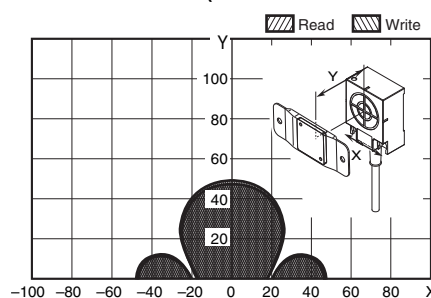

V680-HS52 (embedded in non-metallic material) & V680-D1KP66T-SP (mounted on non-metallic material)

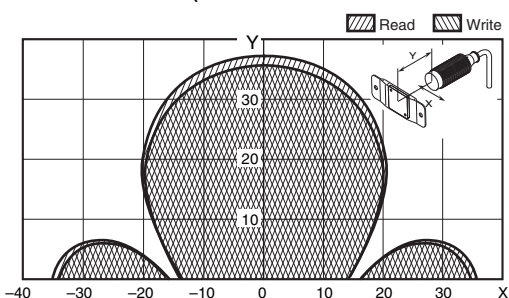

V680-HS65 (mounted on metallic material) & V680-D1KP66T-SP (mounted on non-metallic material)

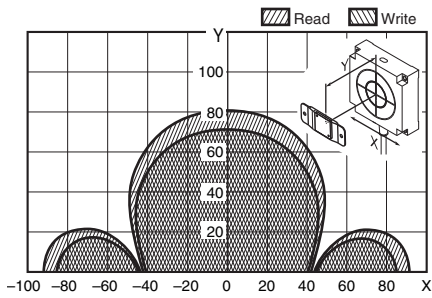

V680-HS63 (mounted on non-metallic material) & V680-D1KP66MT (mounted on metallic surface: steel)

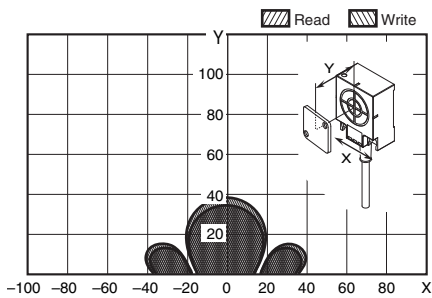

V680-HS52 (embedded in non-metallic material) & V680-D1KP66MT (mounted on metallic surface: steel)

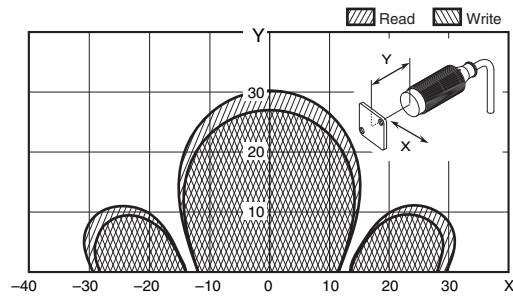

V680-HS65 (mounted on metallic material) & V680-D1K66MT (mounted on metallic surface: steel)

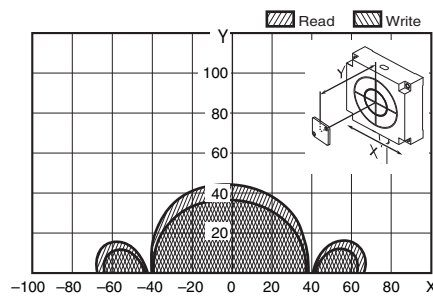

1-kbyte Memory Bolt RF Tags

V680-HS51 (embedded in metallic material) & V680-D1KP52M-BT01 (mounted in metal/non-metallic material)

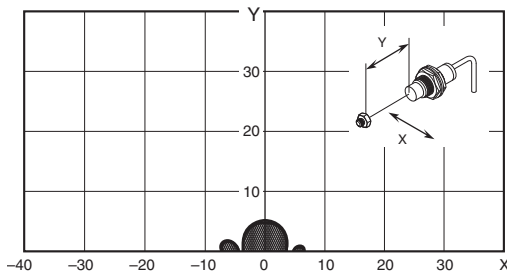

V680-HS51 (embedded in metallic material) & V680-D1KP52M-BT11 (mounted in metal/non-metallic material)

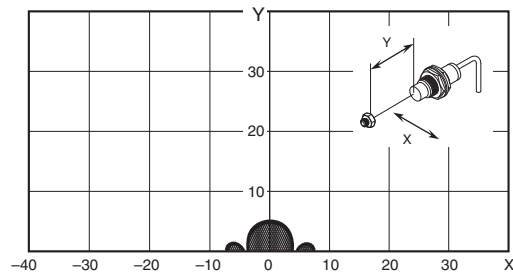

V680-HS52 (embedded in non-metallic material) & V680-D1KP52M-BT01 (mounted in metal/non-metallic material)

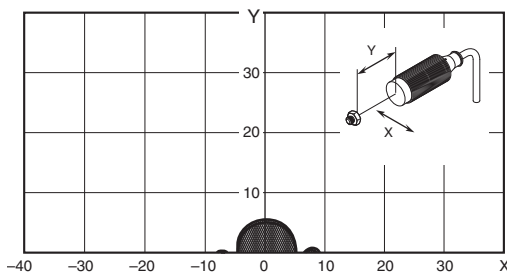

High-temperature Type 1-kbyte Memory RF Tags

V680-HS65 (with metal on back surface) & V680-D1KP58HTN

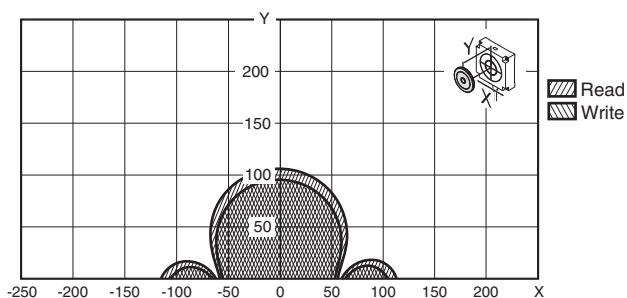

V680-H01-V2 and V680-D1KP58HTN

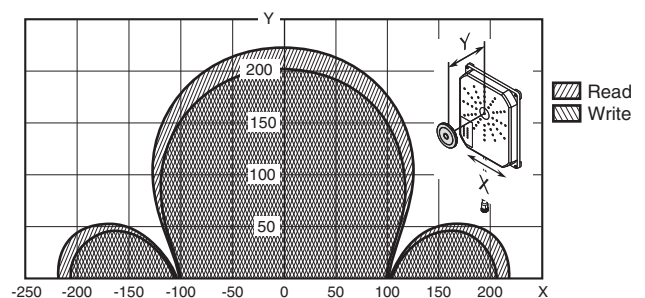

V680 Series

2-kbyte Memory RF Tag

The values given for communications ranges are reference values. Refer to pages 20 to 21, 24 for communications distance specifications. The communications distance will depend on the RF Tags, ambient temperature, surrounding metal, noise, and other factors. Test operation completely when installing a system.

V680-HS63 (mounted on non-metallic material) & V680S-D2KF67 (mounted on non-metallic material)

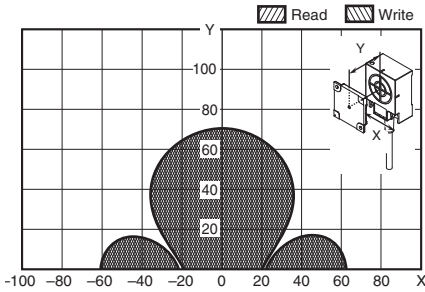

V680-H01-V2 (mounted on non-metallic material) & V680S-D2KF67 (mounted on non-metallic material)

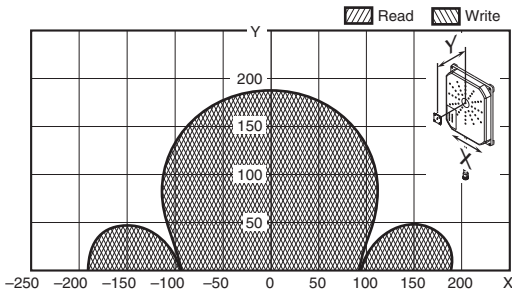

V680-HS63 (mounted on non-metallic material) & V680S-D2KF67M (mounted on metallic surface: steel)

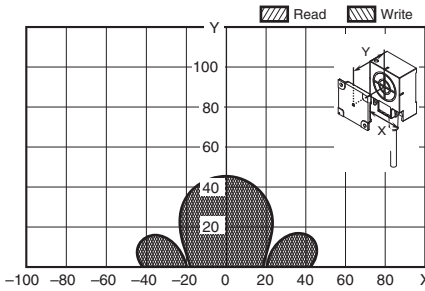

V680-HS63 (with Metal on Back Surface) & V680S-DKF68 (Tag direction: Horizontal)

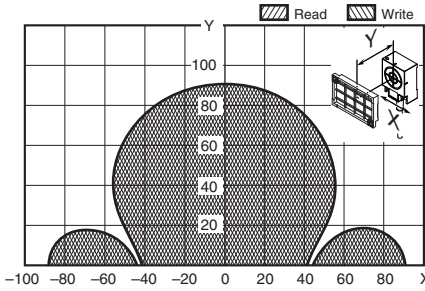

V680-HS65 (with Metal on Back Surface) & V680S-DKF68 (Tag direction: Horizontal)

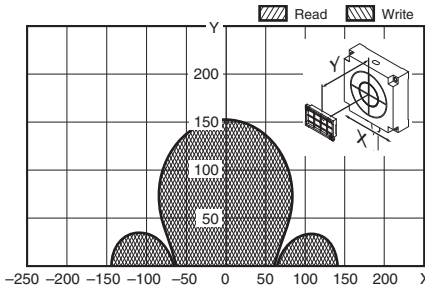

V680-HS65 (mounted on metallic material) & V680S-D2KF67 (mounted on non-metallic material)

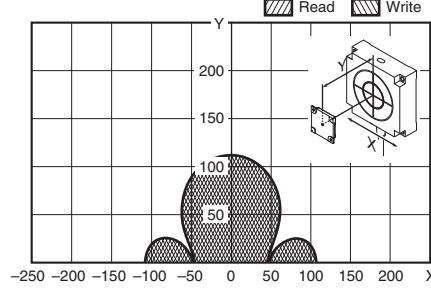

V680-HS52 (embedded in non-metallic material) & V680S-D2KF67M (mounted on metallic surface: steel)

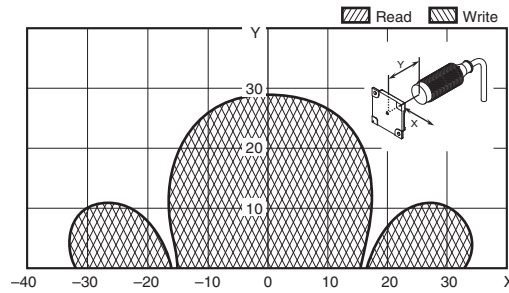

V680-HS65 (mounted on metallic material) & V680S-D2KF67M (mounted on metallic surface: steel)

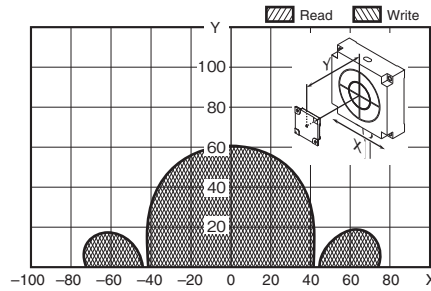

V680-HS63 (with Metal on Back Surface) & V680S-DKF68 (Tag direction: Vertical)

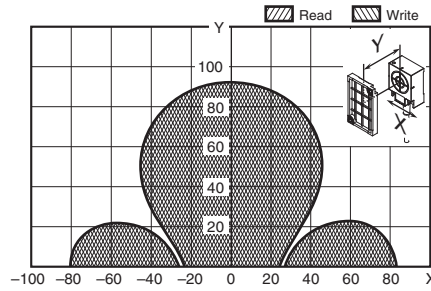

V680-HS65 (with Metal on Back Surface) & V680S-DKF68 (Tag direction: Vertical)

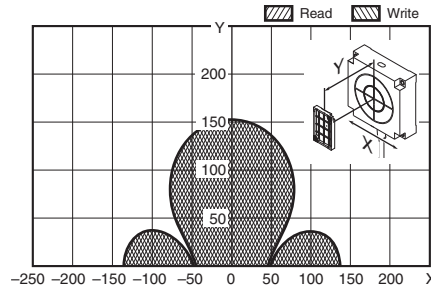

V680-H01-V2 (with Non-Metal on Back Surface) & V680S-DKF68 (Tag direction: Horizontal)

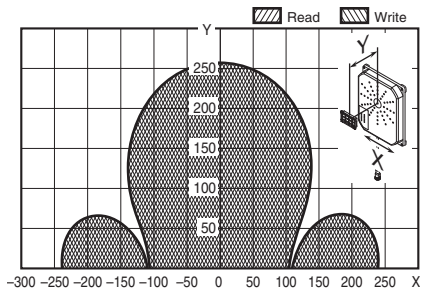

V680-H01-V2 (with Non-Metal on Back Surface) & V680S-DKF68 (Tag direction: Vertical)

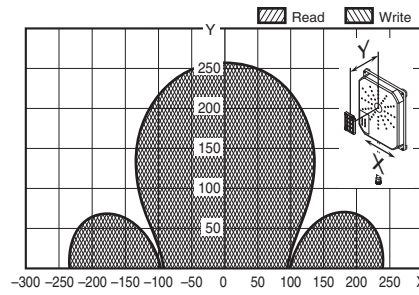

V680-HS63 (with Metal on Back Surface) & V680S-DKF68 (Metal on back: Steel) (Tag direction: Horizontal)

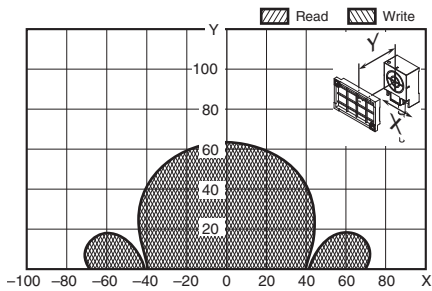

V680-HS63 (with Metal on Back Surface) & V680S-DKF68 (Metal on back: Steel) (Tag direction: Vertical)

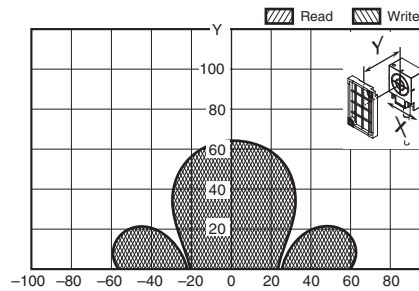

V680-HS65 (with Metal on Back Surface) & V680S-DKF68 (Metal on back: Steel) (Tag direction: Horizontal)

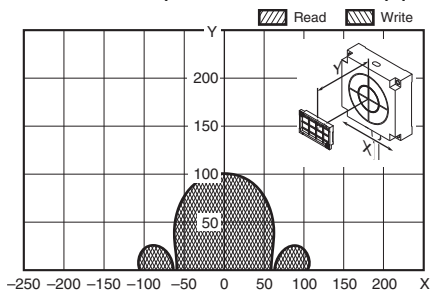

V680-HS65 (with Metal on Back Surface) & V680S-DKF68 (Metal on back: Steel) (Tag direction: Vertical)

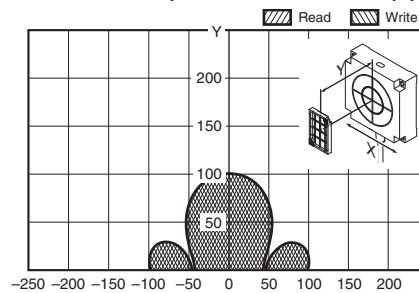

V680-HS52 (embedded in non-metallic material) & V680-D2KF52M (embedded in non-metallic material)

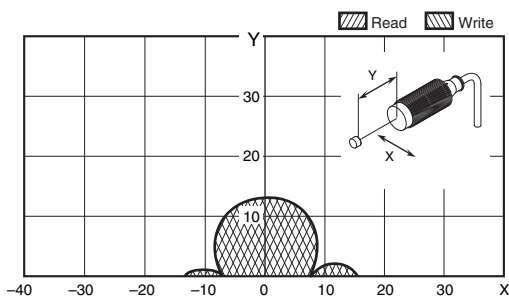

V680-HS52 (embedded in non-metallic material) & V680-D2KF52M (embedded in metallic surface: steel)

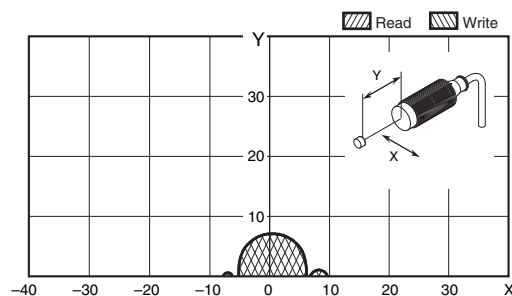

V680-HS51 (embedded in metallic material) & V680-D2KF52M (embedded in non-metallic material)

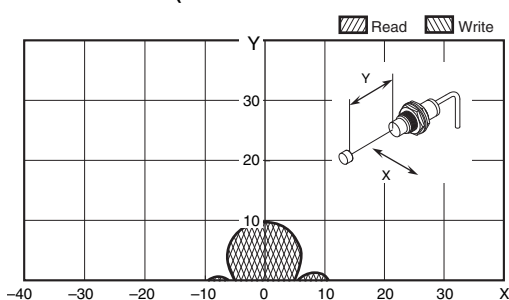

V680-HS51 (embedded in metallic material) & V680-D2KF52M (embedded in metallic surface: steel)

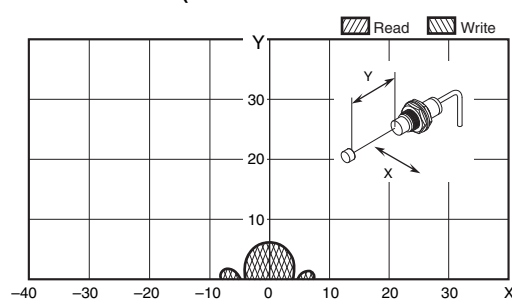

V680 Series

V680-HS63 (mounted on non-metallic material) & V680-D2KF52M (embedded in non-metallic material)

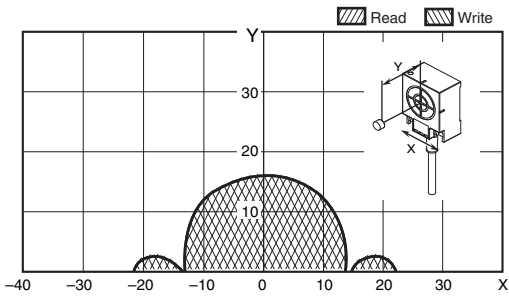

V680-HS52 (embedded in Non-Metal) & V680S-D2KF67 (mounted on non-metallic material)

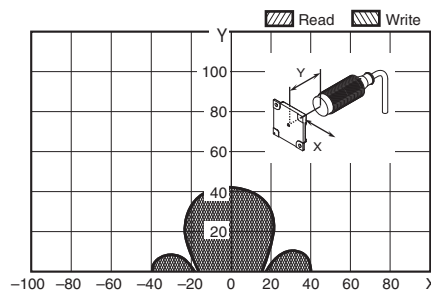

2-kbyte Memory Bolt RF Tags

V680-HS51 (embedded in metallic material) & V680-D2KF52M-BT01 (mounted in metal/non-metallic material)

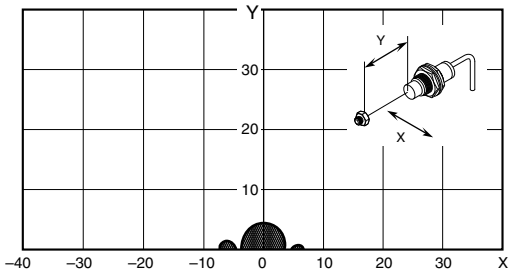

V680-HS51 (embedded in metallic material) & V680-D2KF52M-BT11 (mounted in metal/non-metallic material)

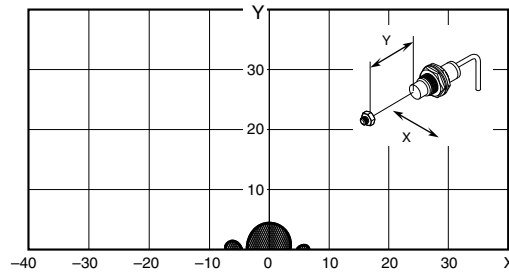

V680-HS52 (embedded in non-metallic material) & V680-D2KF52M-BT01 (mounted in metal/non-metallic material)

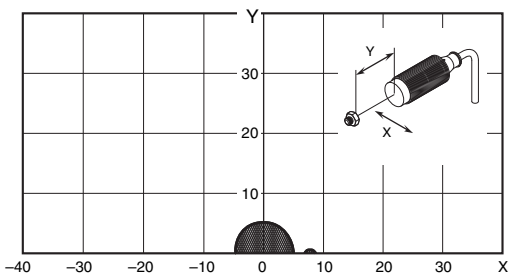

8-kbyte Memory RF Tag

The values given for communications ranges are reference values. Refer to pages 22 to 23 for communications distance specifications. The communications distance will depend on the RF Tags, ambient temperature, surrounding metal, noise, and other factors. Test operation completely when installing a system.

V680-HS52 (embedded in non-metallic material) & V680S-D8KF67 V680-HS63 (mounted on non-metallic material) & V680S-D8KF67

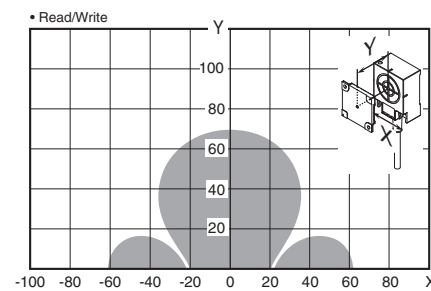
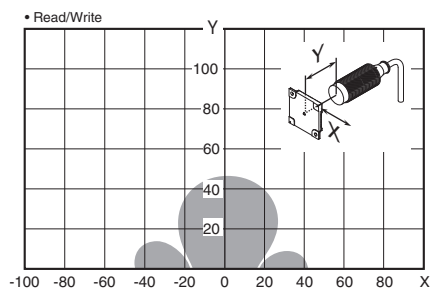

V680-HS65 (mounted on metallic material) & V680S-D8KF67

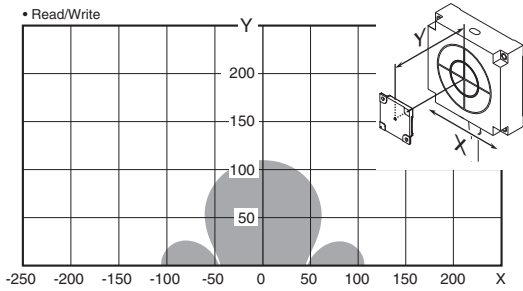

V680-H01-V2 (mounted on non-metallic material) & V680S-D8KF67

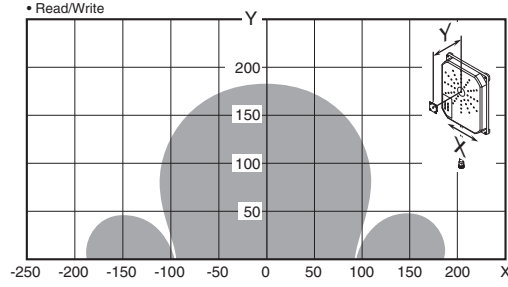

V680-HS52 (embedded in non-metallic material) & V680S-D8KF67M (mounted on metallic surface: steel)

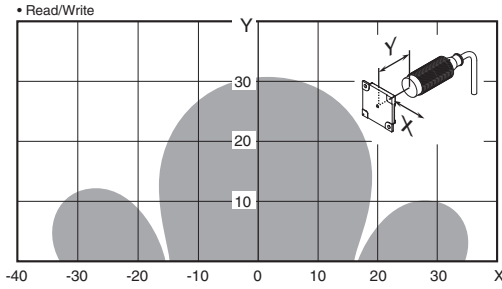

V680-HS63 (mounted on non-metallic material) & V680S-D8KF67M (mounted on metallic surface: steel)

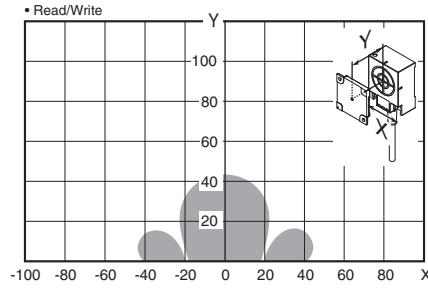

V680-HS65 (mounted in metal) & V680S-D8KF67M (mounted on metallic surface: steel)

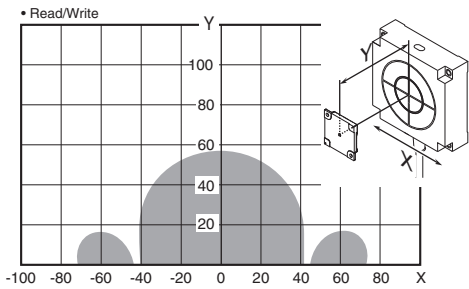

V680-HS63 (mounted on non-metallic material) & V680S-D8KF68 (Tag direction: Horizontal)

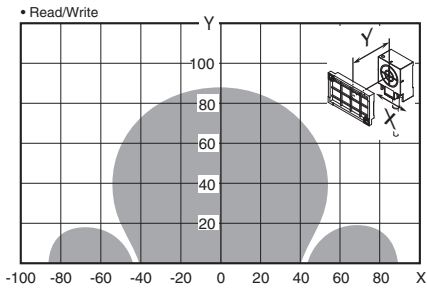

V680-HS63 (mounted on non-metallic material) & V680S-D8KF68 (Tag direction: Vertical)

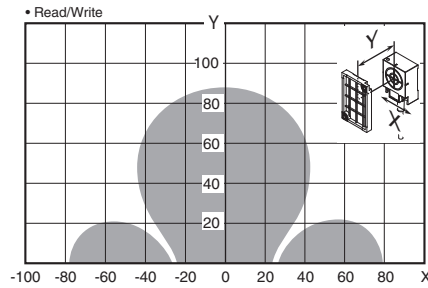

V680-HS65 (mounted on metallic material) & V680S-D8KF68 (Tag direction: Horizontal)

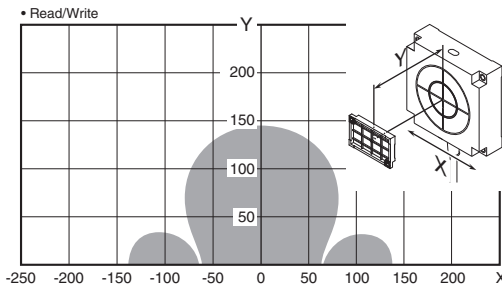

V680-HS65 (mounted on metallic material) & V680S-D8KF68 (Tag direction: Vertical)

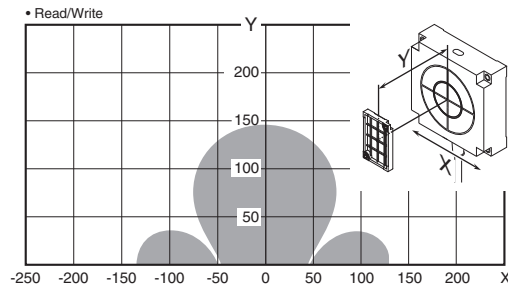

V680 Series

V680-H01-V2 (mounted on non-metallic material) & V680S-D8KF68 (Tag direction: Horizontal)

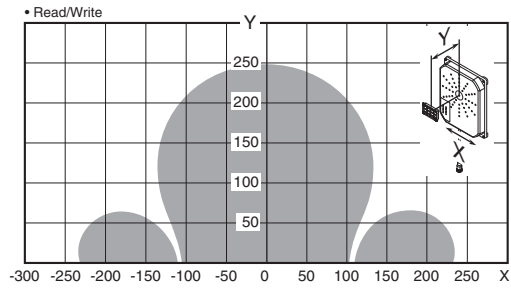

V680-H01-V2 (mounted on non-metallic material) & V680S-D8KF68 (Tag direction: Vertical)

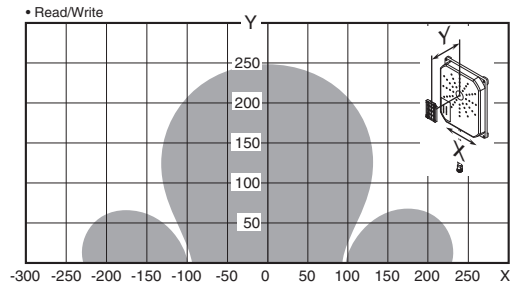

V680-HS63 (mounted on non-metallic material) & V680S-D8KF68M (Metal on back: Steel (Tag direction: Horizontal))

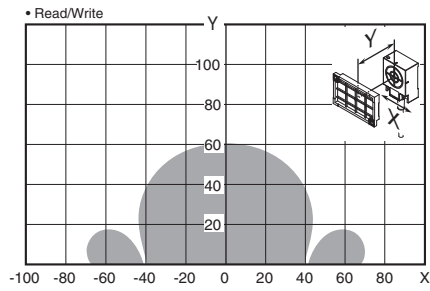

V680-HS63 (mounted on non-metallic material) & V680S-D8KF68M (Metal on back: Steel (Tag direction: Vertical))

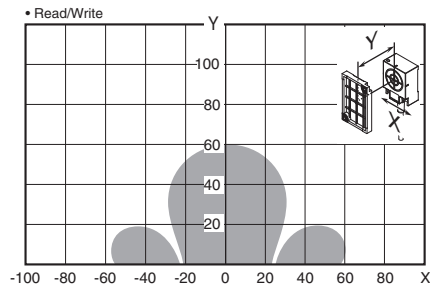

V680-HS65 (mounted on metallic material) & V680S-D8KF68M (Metal on back: Steel (Tag direction: Horizontal))

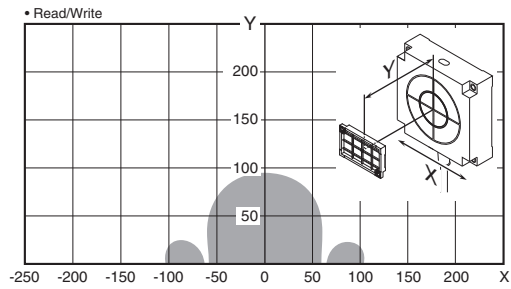

V680-HS65 (mounted on metallic material) & V680S-D8KF68M (Metal on back: Steel (Tag direction: Vertical))

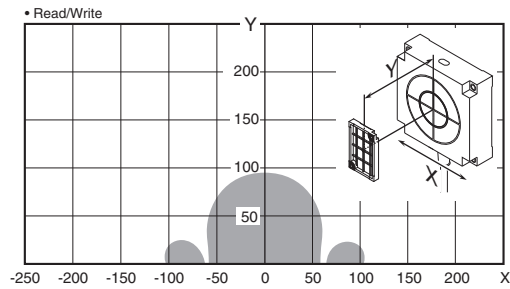

**DeviceNet ID Slave (When Using the V680-HAM42-DRT)
PROFIBUS ID Slave (When Using the V680-HAM42-PRT)
ID Flag Sensors (When Using the V680-HAM91/-HAM81)**

1-kbyte Memory RF Tag

The values given for communications ranges are reference values. Refer to pages 25 to 26, 30 for communications distance specifications. For information on the combinations that can be used, refer to Combinations of Amplifier Units, Antennas, and RF Tags on pages 2 to 3. The communications distance will depend on the RF Tags, ambient temperature, surrounding metal, noise, and other factors. Test operation completely when installing a system.

V680-HS52 (embedded in non-metallic material) & V680-D1KP52MT (embedded in non-metallic material)

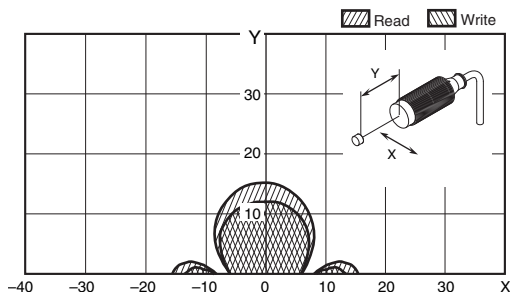

V680-HS51 (embedded in metallic material) & V680-D1KP52MT (embedded in non-metallic material)

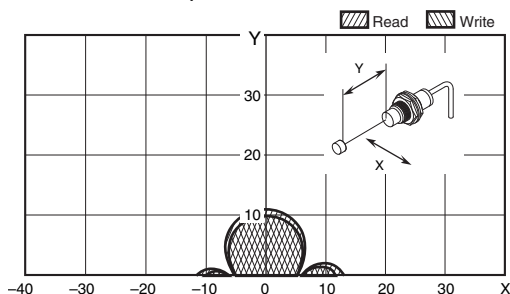

V680-HS63 (mounted on non-metallic material) & V680-D1KP52MT (embedded in non-metallic material)

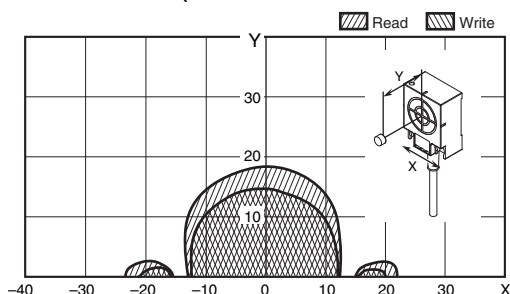

V680-HS63 (mounted on non-metallic material) & V680-D1KP66T (mounted on non-metallic material)

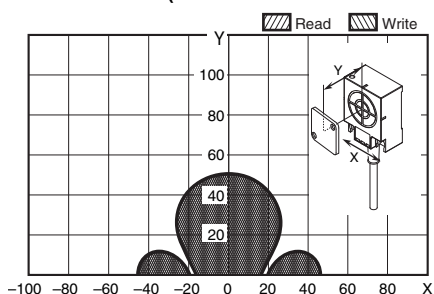

V680-HS52 (embedded in non-metallic material) & V680-D1KP66T-SP (embedded in non-metallic material)

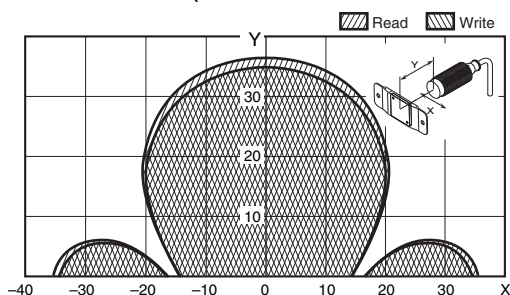

V680-HS52 (embedded in non-metallic material) & V680-D1KP52MT (embedded in metallic surface: steel)

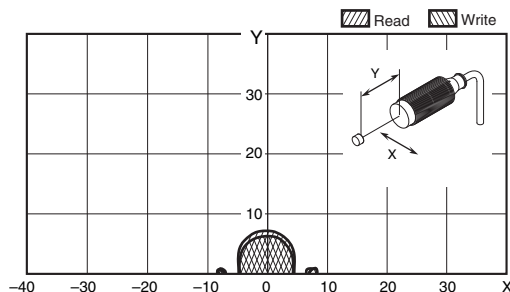

V680-HS51 (embedded in metallic material) & V680-D1KP52MT (embedded in metallic surface: steel)

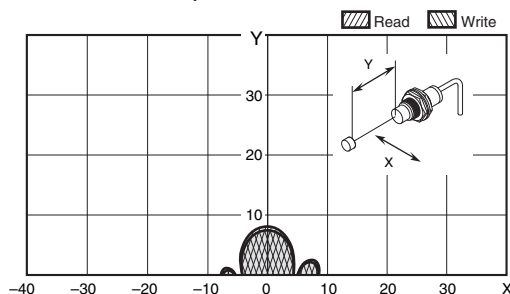

V680-HS52 (embedded in non-metallic material) & V680-D1KP66T (mounted on non-metallic material)

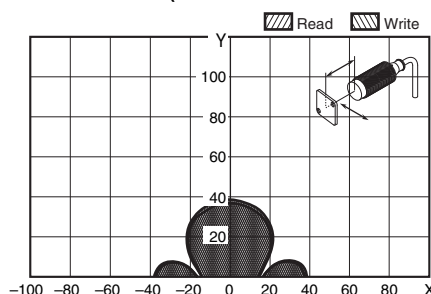

V680-HS65 (mounted on metallic material) & V680-D1KP66T (mounted on non-metallic material)

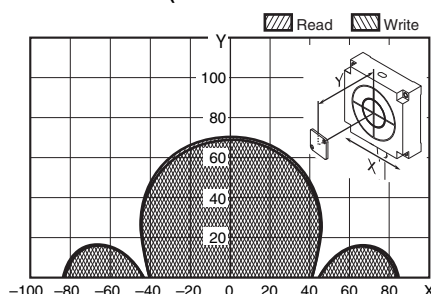

V680-HS63 (mounted on non-metallic material) & V680-D1KP66T-SP (mounted on non-metallic material)

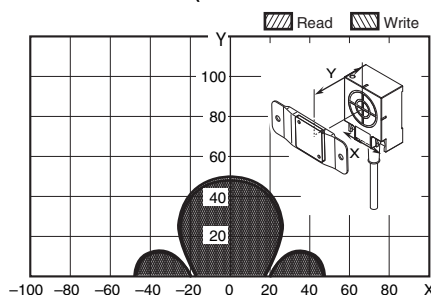

V680 Series

V680-HS65 (mounted on metallic material) & V680-D1KP66T-SP (mounted on non-metallic material)

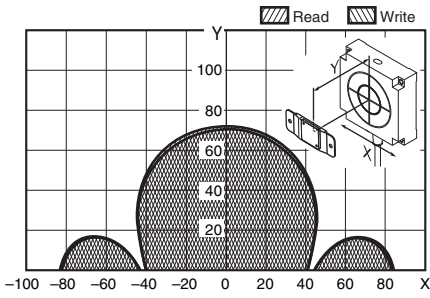

V680-HS63 (mounted on non-metallic material) & V680-D1KP66MT (mounted on metallic surface: steel)

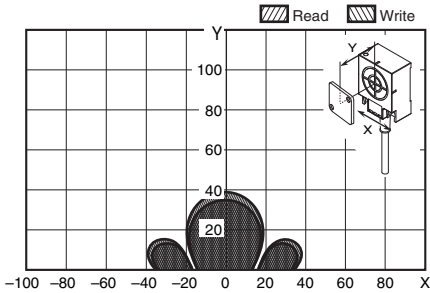

V680-HS52 (embedded in non-metallic material) & V680-D1KP66MT (mounted on metallic surface: steel)

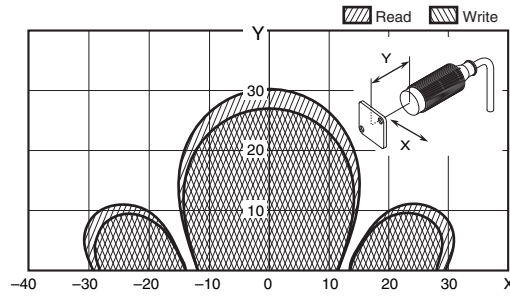

V680-HS65 (mounted on metallic material) & V680-D1K66MT (mounted on metallic surface: steel)

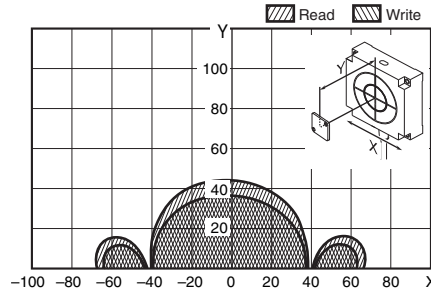

1-kbyte Memory Bolt RF Tags

V680-HS51 (embedded in metallic material) & V680-D1KP52M-BT01 (mounted in metal/non-metallic material)

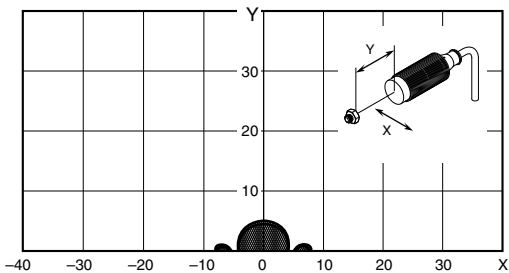

V680-HS52 (embedded in non-metallic material) & V680-D1KP52M-BT01 (mounted in metal/non-metallic material)

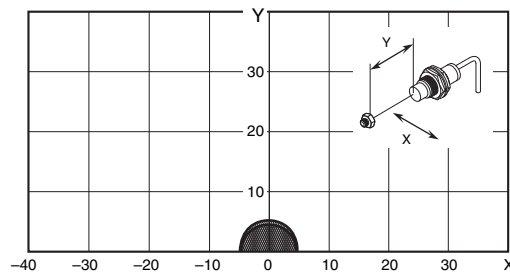

2-kbyte Memory RF Tag

The values given for communications ranges are reference values. Refer to pages 27 to 28, 30 for communications distance specifications. For information on the combinations that can be used, refer to Combinations of Amplifier Units, Antennas, and RF Tags on pages 2 to 3. The communications distance will depend on the RF Tags, ambient temperature, surrounding metal, noise, and other factors. Test operation completely when installing a system.

V680-HS63 (mounted on non-metallic material) & V680S-D2KF67 (mounted on non-metallic material)

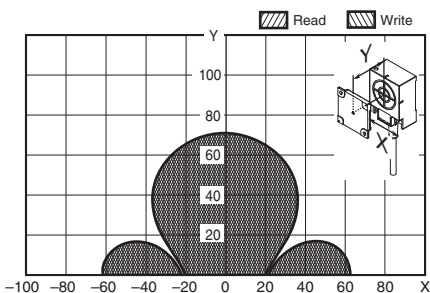

V680-HS65 (mounted on metallic material) & V680S-D2KF67 (mounted on non-metallic material)

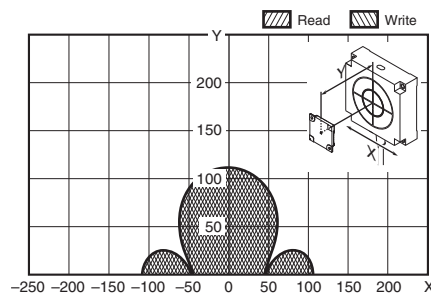

V680-HS52 (embedded in non-metallic material) & V680S-D2KF67M (mounted on metallic surface: steel)

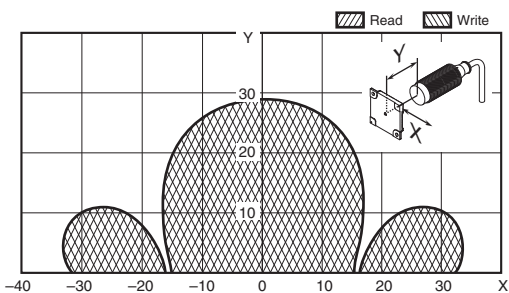

V680-HS63 (mounted on non-metallic material) & V680S-D2KF67M (mounted on metallic surface: steel)

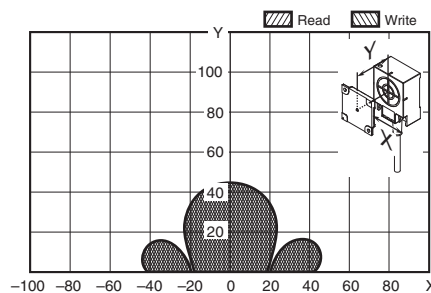

V680-HS65 (mounted on metallic material) & V680S-D2KF67M (mounted on metallic surface: steel)

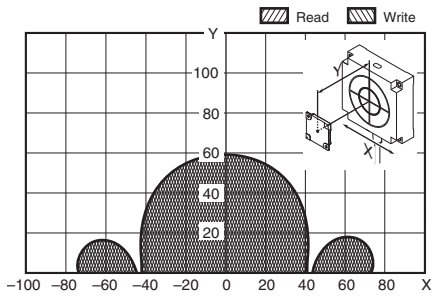

V680-HS63 (with Metal on Back Surface) & V680S-D2KF68 (Tag direction: Horizontal)

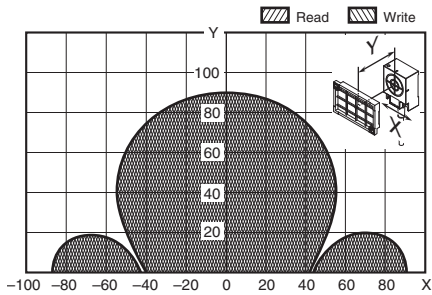

V680-HS63 (with Metal on Back Surface) & V680S-D2KF68 (Tag direction: Vertical)

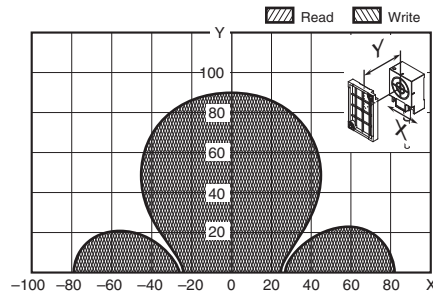

V680-HS65 (with Metal on Back Surface) & V680S-D2KF68 (Tag direction: Horizontal)

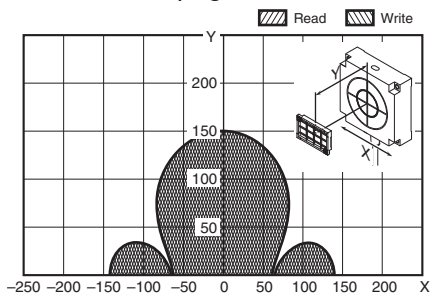

V680-HS65 (with Metal on Back Surface) & V680S-D2KF68 (Tag direction: Vertical)

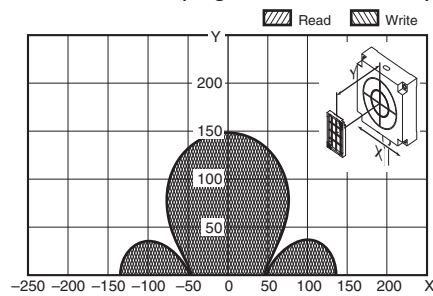

V680-HS63 (with Metal on Back Surface) & V680S-D2KF68M (Metal on back: Steel) (Tag direction: Horizontal)

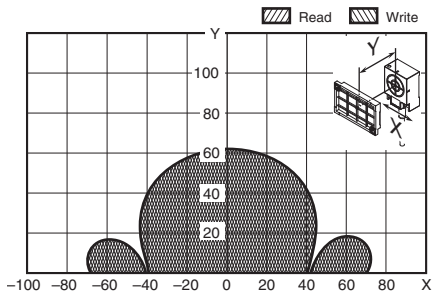

V680-HS63 (with Metal on Back Surface) & V680S-D2KF68M (Metal on back: Steel) (Tag direction: Vertical)

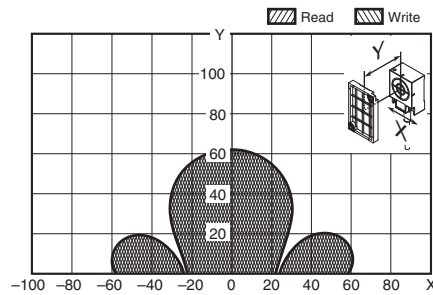

V680-HS65 (with Metal on Back Surface) & V680S-D2KF68M (Metal on back: Steel) (Tag direction: Horizontal)

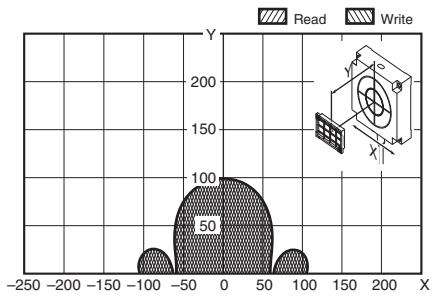

V680-HS65 (with Metal on Back Surface) & V680S-D2KF68M (Metal on back: Steel) (Tag direction: Vertical)

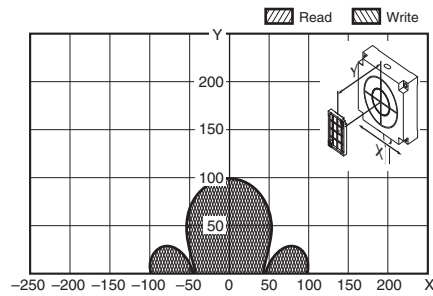

V680 Series

V680-HS52 (embedded in non-metallic material) & V680-D2KF52M (embedded in non-metallic material)

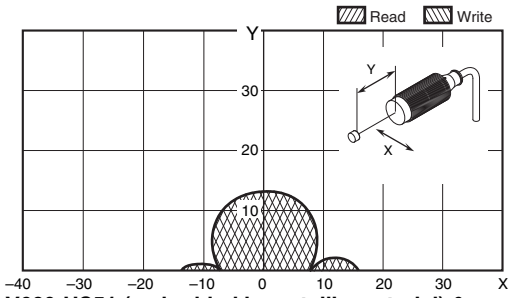

V680-HS51 (embedded in metallic material) & V680-D2KF52M (embedded in non-metallic material)

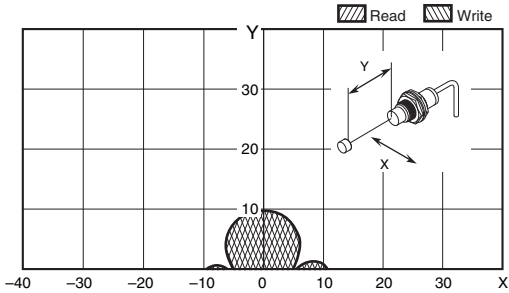

V680-HS63 (mounted on non-metallic material) & V680-D2KF52M (embedded in non-metallic material)

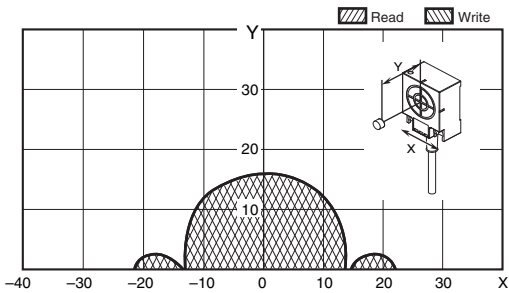

2-kbyte Memory Bolt RF Tags

V680-HS51 (embedded in metallic material) & V680-D2KF52M-BT01 (mounted in metal/non-metallic material)

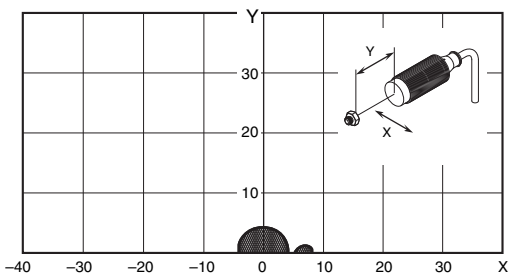

V680-HS52 (embedded in non-metallic material) & V680-D2KF52M (embedded in metallic surface: steel)

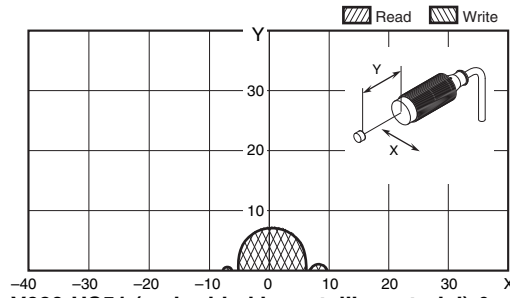

V680-HS51 (embedded in metallic material) & V680-D2KF52M (embedded in metallic surface: steel)

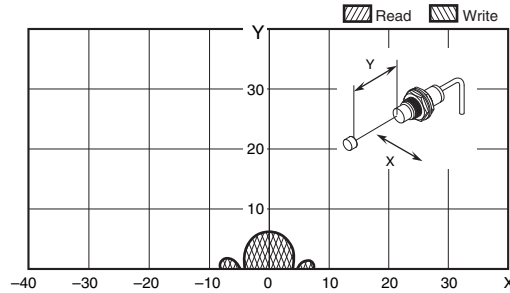

V680-HS52 (embedded in non-metallic material) & V680S-D2KF67 (mounted on non-metallic material)

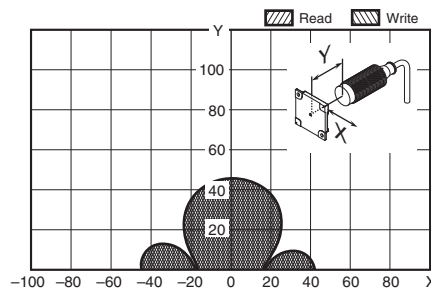

V680-HS52 (embedded in non-metallic material) & V680-D2KF52M-BT01 (mounted in metal/non-metallic material)

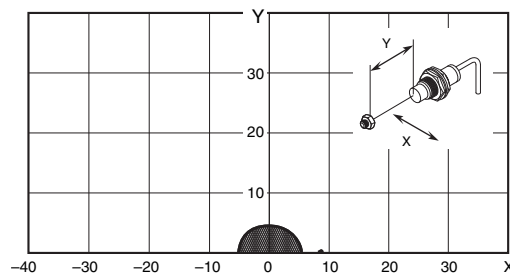

8-kbyte Memory RF Tag

The values given for communications ranges are reference values. Refer to pages 29 to 30 for communications distance specifications. For information on the combinations that can be used, refer to Combinations of Amplifier Units, Antennas, and RF Tags on pages 2 to 3. The communications distance will depend on the RF Tags, ambient temperature, surrounding metal, noise, and other factors. Test operation completely when installing a system.

V680-HS52 (embedded on non-metallic material) & V680S-D8KF67

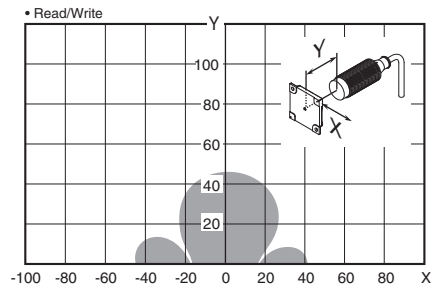

V680-HS63 (mounted on non-metallic material) & V680S-D8KF67

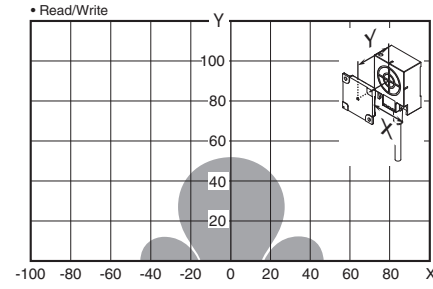

V680-HS65 (mounted on metallic material) & V680S-D8KF67

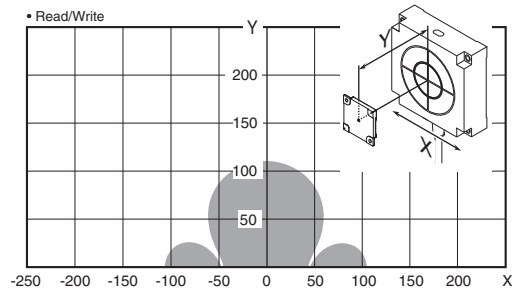

V680-HS52 (embedded on non-metallic material) & V680S-D8KF67M (mounted on metallic surface: steel)

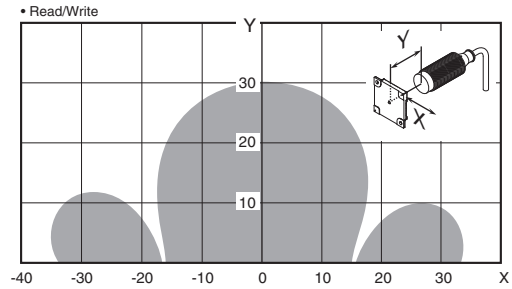

V680-HS63 (mounted on non-metallic material) & V680S-D8KF67M (mounted on metallic surface: steel)

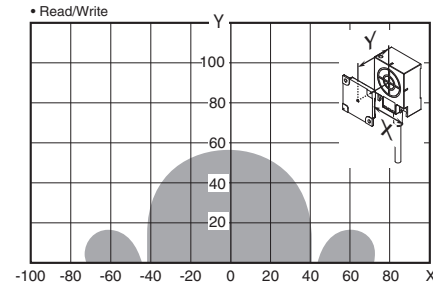

V680-HS65 (mounted on metallic material) & V680S-D8KF67M (mounted on metallic surface: steel)

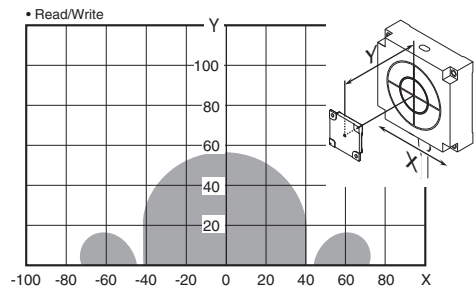

V680 Series

V680-HS63 (mounted on metallic surface: steel) & V680S-D8KF68 (Tag direction: Horizontal)

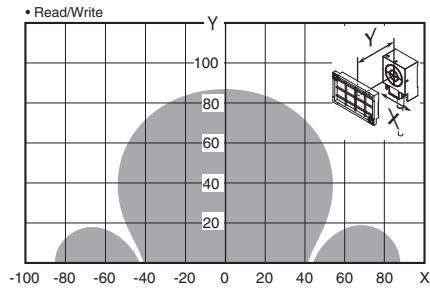

V680-HS63 (mounted on metallic surface: steel) & V680S-D8KF68 (Tag direction: Vertical)

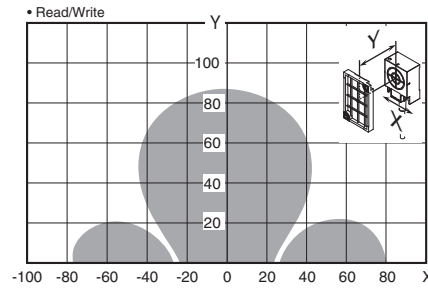

V680-HS65 (mounted on metallic surface: steel) & V680S-D8KF68 (Tag direction: Horizontal)

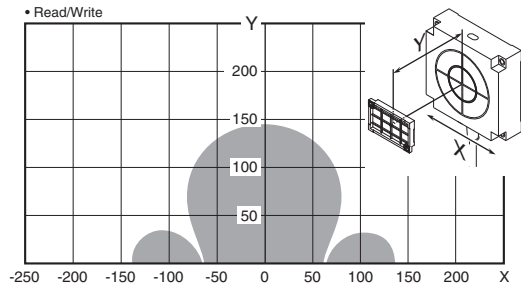

V680-HS65 (mounted on metallic surface: steel) & V680S-D8KF68 (Tag direction: Vertical)

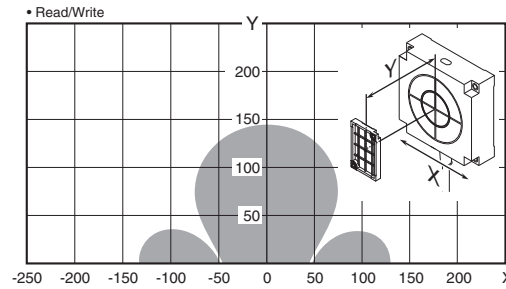

V680-HS63 (mounted on metallic surface: steel) & V680S-D8KF68M (Tag direction: Horizontal)

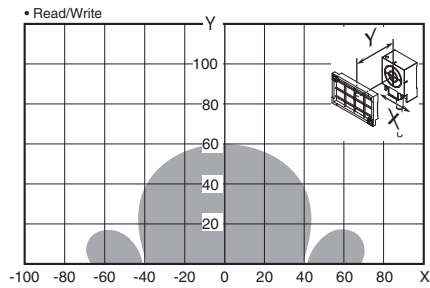

V680-HS63 (mounted on metallic surface: steel) & V680S-D8KF68M (Tag direction: Vertical)

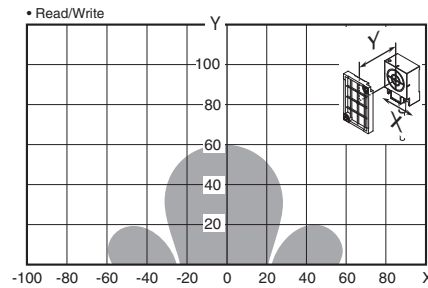

V680-HS65 (mounted on metallic surface: steel) & V680S-D8KF68M (Tag direction: Horizontal)

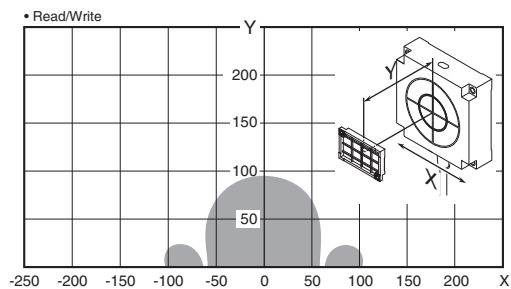

V680-HS65 (mounted on metallic surface: steel) & V680S-D8KF68M (Tag direction: Vertical)

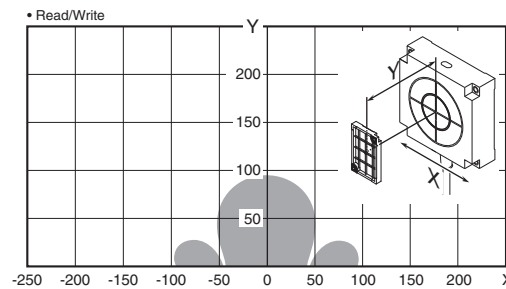

Communications Time

Communications Time between Antennas and Tags

ID Controllers (V680-CA5D0□-V2, NX-V680C1/C2, CJ1W-V680C11/C12, CS1W-V680C11/C12)

1-kbyte Memory RF Tag

V680-D1KP□ (used in combination with the V680-HS□□ Antenna, V680-HA63A Amplifier Unit and V680-H01-V2 Antenna)

V680-D1KP58HTN (used in combination with the V680-H01-V2 Antenna)

● Communications speed: Normal mode

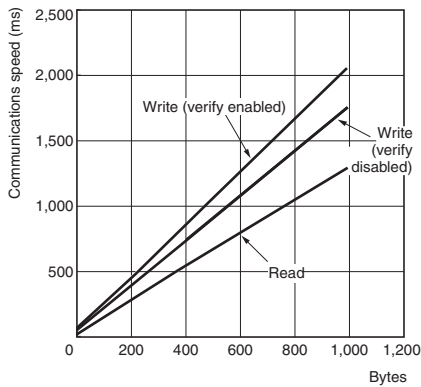

● Communications speed: High-speed mode

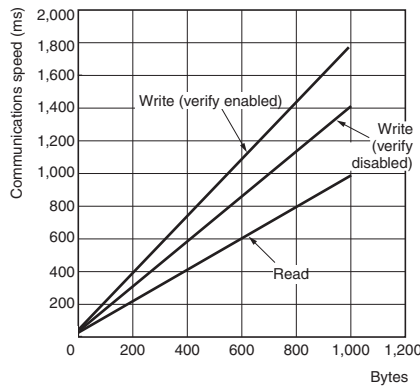

| Communications speed setting | Command | Write verification setting | Communications time N: No. of bytes processed |
|------------------------------|---------|----------------------------|---|
| Normal mode | Read | – | $T=1.3N+31$ |
| | Write | Enabled | $T=2.1N+58$ |
| Disabled | | $T=1.8N+56$ | |
| High-speed mode *1, *2 | Read | – | $T=1.0N+29$ |
| | Write | Enabled | $T=1.8N+51$ |
| Disabled | | $T=1.5N+47$ | |

*1. The V680-H01 Antenna cannot be used in high-speed mode.

*2. When using multi-access or FIFO communications options, normal-mode communications speed will be used regardless of the high-speed mode setting.

2-kbyte Memory RF Tag

V680S-D2KF□□, V680S-D2KF52M/-D2KF52M-BT□□ (used in combination with the V680-HS□□ Antenna, V680-HA63B Amplifier Unit and V680-H01-V2 Antenna)

● Communications speed: Normal mode

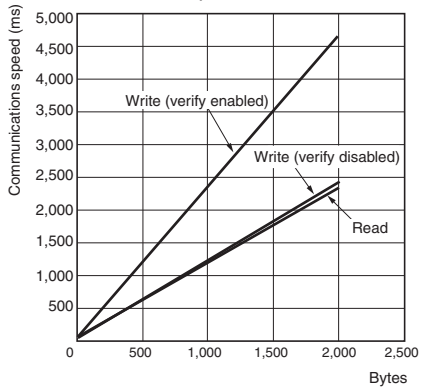

● Communications speed: High-speed mode

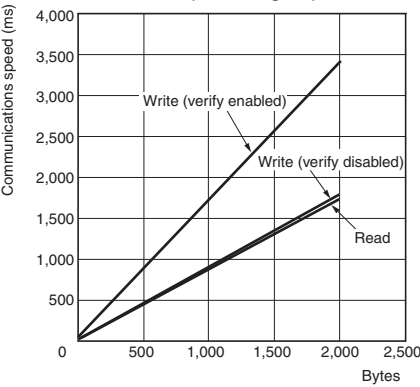

| Communications speed setting | Command | Write verification setting | Communications time N: No. of bytes processed |
|------------------------------|---------|----------------------------|---|
| Normal mode | Read | – | $T=1.2N+30$ |
| | Write | Enabled | $T=2.4N+49$ |
| Disabled | | $T=1.2N+49$ | |
| High-speed mode * | Read | – | $T=0.9N+27$ |
| | Write | Enabled | $T=1.7N+49$ |
| Disabled | | $T=0.9N+41$ | |

* When using multi-access or FIFO communications options, normal-mode communications speed will be used regardless of the high-speed mode setting.

8-kbyte Memory RF Tag

V680S-D8KF□□

(used in combination with the V680-HS□□ Antenna and V680-HA63B Amplifier Unit)

● Communications speed: Normal mode

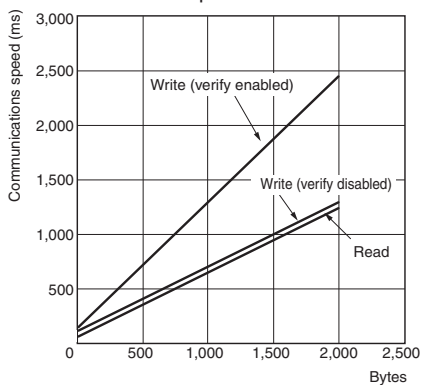

● Communications speed: High-speed mode

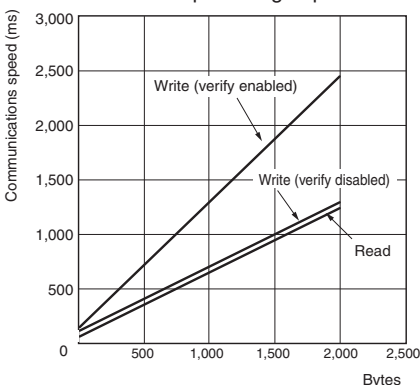

| Communications speed setting | Command | Communications time N: No. of bytes processed |
|------------------------------|-------------------------|---|
| Normal mode | Read | $T=0.6N+47$ |
| | Write (verify enabled) | $T=1.2N+128$ |
| | Write (verify disabled) | $T=0.6N+101$ |
| High-speed mode * | Read | $T=0.6N+47$ |
| | Write (verify enabled) | $T=1.2N+128$ |
| | Write (verify disabled) | $T=0.6N+101$ |

* When using V680S-D8KF□□ RF Tag, normal-mode communications speed will be used regardless of the high-speed mode setting.

V680 Series

Communications Time (Communications Time between Antenna and RF Tag + Processing Time at Amplifier Unit)

DeviceNet ID Slave (V680-HAM42-DRT)

PROFIBUS ID Slave (V680-HAM42-PRT)

1-kbyte Memory RF Tags

V680-D1KP□□ (V680-HS□□ Antenna)

| Communications time setting | Command | Communications time (ms) | | | |
|-----------------------------|-------------------------|--|---------------------|---------------------|------------------------|
| | | 4-byte Access Mode | 26-byte Access Mode | 58-byte Access Mode | V600-compatible mode * |
| Normal | Read | 67 | 95 | 137 | 67 |
| | Write with Verification | 105 | 143 | 210 | 105 |
| | Data Fill | V680-HAM42-DRT: 17.5 × No. of processed blocks + 89.2 V680-HAM42-PRT: 20.6 × No. of processed blocks + 76.8 | | | – |
| High speed | Read | 63 | 85 | 117 | – |
| | Write with Verification | 89 | 128 | 186 | – |
| | Data Fill | V680-HAM42-DRT: 14.8 × No. of processed blocks + 71.7 V680-HAM42-PRT: 18.8 × No. of processed blocks + 66.4 | | | – |

2-kbyte Memory RF Tags

V680S-D2KF□, V680S-D2KF52M/-D2KF52M-BT□□ (V680-HS□□ Antenna)

| Communications time setting | Command | Communications time (ms) | | | |
|-----------------------------|-------------------------|--|---------------------|---------------------|------------------------|
| | | 4-byte Access Mode | 26-byte Access Mode | 58-byte Access Mode | V600-compatible mode * |
| Normal | Read | 65 | 92 | 130 | 65 |
| | Write with Verification | 105 | 142 | 219 | 105 |
| | Data Fill | V680-HAM42-DRT: 17.5 × No. of processed blocks + 89.2 V680-HAM42-PRT: 21.2 × No. of processed blocks + 86.4 | | | – |
| High speed | Read | 61 | 81 | 110 | – |
| | Write with Verification | 86 | 124 | 178 | – |
| | Data Fill | V680-HAM42-DRT: 14.8 × No. of processed blocks + 71.7 V680-HAM42-PRT: 17.2 × No. of processed blocks + 74.6 | | | – |

8-kbyte Memory RF Tags

V680S-D8KF□□ (V680-HS□□ Antenna)

| Communications time setting | Command | Communications time (ms) | | | |
|-----------------------------|-------------------------|--|---------------------|---------------------|-------------------------|
| | | 4-byte Access Mode | 26-byte Access Mode | 58-byte Access Mode | V600-compatible mode *1 |
| Normal | Read | 42 | 42 | 60 | 42 |
| | Write with Verification | 133 | 133 | 170 | 133 |
| | Data Fill | V680-HAM42-DRT: 9.1 × No. of processed blocks + 105.5 V680-HAM42-PRT: 9.1 × No. of processed blocks + 105.5 | | | – |
| High speed #2 | Read | 42 | 42 | 60 | 42 |
| | Write with Verification | 133 | 133 | 170 | 133 |
| | Data Fill | V680-HAM42-DRT: 9.1 × No. of processed blocks + 105.5 V680-HAM42-PRT: 9.1 × No. of processed blocks + 105.5 | | | – |

*1. The V680-HAM42-PRT does not support V600-compatible mode.

*2. When using V680S-D8KF□□ RF Tag, normal-mode communications speed will be used regardless of the high-speed mode setting.

ID Flag Sensors (V680-HAM91/-HAM81)

| Operating Mode | Communications time (ms) | |
|-------------------------------|------------------------------|---------------------------|
| | Read | Write |
| RF Tag | Data Read, Verification read | Write, Bit Set, Bit Clear |
| 1-kbyte/2-kbyte Memory RF Tag | 43 | 87 |
| 8-kbyte Memory RF Tags | 50 | 84 |

$$\text{RF Tag travel speed (conveyor speed)} = \frac{\text{Travel distance (D) in interrogation zone}}{\text{Communications time (T)}}$$

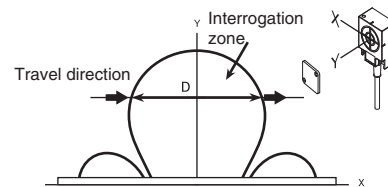

Calculation Example

Read Processing Using Combination of V680-D1KP66T and V680-HS63

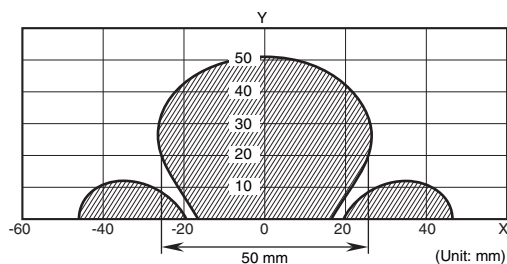

$$\text{RF Tag travel speed (m/min)} = \frac{50(\text{mm})}{43(\text{ms})} \doteq 69(\text{m/min})$$

- Note:**
1. The travel speed depends on factors such as the communications distance Y and axis offset. Therefore, it is recommended to refer to the interrogation zone figure and to perform operation using the widest part of the area.
 2. The calculated value is a rough guide.
Perform testing with the actual devices before actual operation.
 3. This calculation formula does not include communications error processing.

TAT When Using an ID Controller (Reference Values)

TAT (Turn Around Time)

TAT refers to the total time required from the point at which a host device (such as a personal computer) starts sending a command until a response is received.

$$\text{TAT} = \text{Command send time} + \text{RF Tag communication time} + \text{response}$$

- Command send time: This is the time required for sending a command from the host device to the Controller. It varies depending on the communications speed and format.
- RF Tag communication time: This is the time required for communication between the Antenna and the RF Tag.
- Response receipt time: This is the time required for returning a response from the Controller to the host device. It varies depending on the communications speed and format.

- For an ordinary command

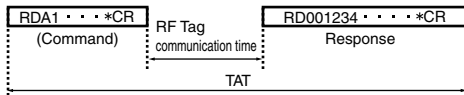

- Expansion Read Command

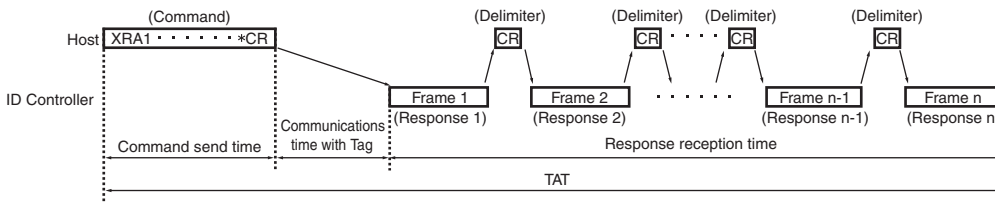

- Expansion Write Command

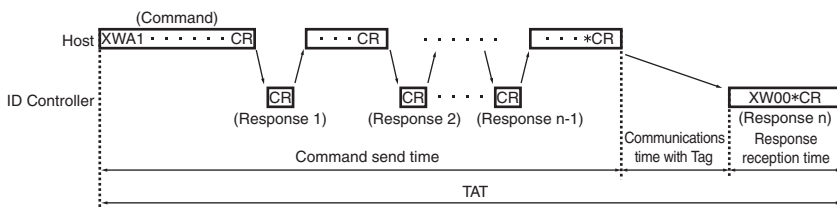

Safety Precautions

⚠ WARNING

This product is not designed or rated for ensuring safety of persons.
Do not use it for such purposes.



* This catalog is intended only to help select the appropriate product. Be sure to read the User's Manual for usage precautions prior to using the product.

Precautions for Safe Use

To ensure safety, be sure to follow the following precautions:

1. Do not operate this product in any flammable, explosive, or corrosive gas environment.
2. Do not disassemble, repair, or remodel this product.
3. Tighten the base lock screws and terminal block screws completely.
4. Be sure to use wiring crimp terminals of the specified size.
5. If any cable has a locking mechanism, be sure to check that it has been locked before using it.
6. The DC power supply must be within the specified rating (24 VDC +10%/–15%).
7. Do not reverse the power supply connection.
8. Do not insert water, wire, etc., into any of the gaps in the case. Doing so may cause fire or electric shock.
9. Turn OFF the Controller or ID Sensor Unit power before attaching or removing the Antenna.
10. If multiple Antennas are mounted near each other, communications performance may decrease due to mutual interference. Refer to the manual for the Antennas and RF Tags and check to make sure there is no mutual interference before installation.
11. To remove the ID Controller, catch a tool on the mounting hook and gently remove the Unit.
12. Wire correctly and do not short-circuit the load. The ID Controller may rupture or burn.
13. Do not use in environments that are subject to oil.
14. Never use an AC power supply.
15. In the event that the product exhibits any abnormal condition, immediately stop using the system, turn OFF the power, and contact your OMRON sales representative.
16. Dispose of this product as industrial waste.
17. Be sure to follow any other warnings, cautions, and notices given in this document.

Precautions for Correct Use

Please observe the following precautions to prevent failure to operate, malfunctions, or undesirable effects on product performance.

Installation Site

Install the product at a location where:

- It is not exposed to corrosive gases, dust, metal chips, or salt.
- The ambient operating temperature is within the range stipulated in the specifications.
- There are no sudden variations in temperature (no condensation).
- The ambient operating humidity is within the range stipulated in the specifications.
- No vibration or shock exceeding the values stipulated in the specifications is transmitted directly to the body of the product.
- It is not subject to splashing water, oil, or chemical substances.

Installation

- The product uses the 13.56-MHz frequency band to communicate with RF Tags. Some devices, such as some motors, inverters, and switching power supplies, generate electromagnetic waves (i.e., noise) that can affect communications with RF Tags. If any of these devices are nearby, communications with RF Tags may be affected or RF Tags may be destroyed. If the product is to be used near such devices, check the effects on communications before using the product.
- To minimize the general influence of noise, observe the following precautions:
 1. Ground any metallic material located around this device to 100Ω or less.
 2. Keep the product away from high voltage and heavy current.
- Do not pull on the cable.
- Do not use products that are not waterproof in misty environments.
- Do not subject the products to chemicals that adversely affect product materials.
- When installing the product, tighten screws to the following torque:

| | |
|----------------------|-------------|
| Controller: | 1.2 N·m max |
| ID Sensor Unit: | 0.4 N·m |
| V680-HS51 Antenna: | 6 N·m |
| V680-HS52 Antenna: | 40 N·m |
| V680-HS63 Antenna: | 1.2 N·m |
| V680-HS65 Antenna: | 1.2 N·m |
| V680-H01-V2 Antenna: | 1.2 N·m |

 (Attach the enclosed Mounting Brackets)

| | |
|-------------------------|----------------|
| V680-D1KP66T/-D1KP66MT: | 0.5 N·m |
| V680-D1KP66T-SP: | 1.2 N·m |
| V680-D1KP54T: | 0.3 to 0.5 N·m |
| V680S-D2KF67/-D2KF67M: | 0.6 N·m |
| V680S-D2KF68/-D2KF68M: | 1.2 N·m |
| V680S-D8KF67/-D8KF67M: | 0.6 N·m |
| V680S-D8KF68/-D8KF68M: | 1.2 N·m |
- Do not pull the Antenna connector over the power of 30 N. The Antenna connector may be broken.
- Transmission will not be possible if the front and back panels are mistakenly reversed and the Unit is mounted to a metallic surface.

| |
|---------------|
| V680S-D2KF67M |
| V680S-D2KF68M |
- The transmission distance will be reduced when the Unit is not mounted to a metallic surface.

| |
|---------------|
| V680S-D2KF67M |
| V680S-D2KF68M |
| V680S-D8KF67M |
| V680S-D8KF68M |
- If multiple Antennas are mounted near each other, communications performance may decrease due to mutual interference. Refer to the User's Manual (Cat. No. Z248) and check to make sure there is no mutual interference.
- Depending on the operating environment, the case surface may become fogged, but basic performance will not be affected.
- When Antenna (only V680-H01-V2) is used in the United States and Canada, the ferrite core (ZCAT3035-1330) of the antenna's attachment is installed on controller's (V680-CA5D01-V□) DC power cable.
- The communications range is adversely affected if there is any metal material around the RF Tag.
- The maximum communications range can be obtained when the Antenna faces the RF tag directly. When the RF tag is installed at a tilt, the communications range is reduced. Consider the effect of the RF tag at tilt when installing the RF Tag.
- Provide the mounting distances between plural RF tags to prevent them from malfunctions due to mutual interference.
- If the central axis of an antenna and RF tag shifts, a communications range will fall.

V680 Series

Communications with Host (V680-HAM91/-HAM81)

The I/O status may be unstable when the ID Controller is started. After turning ON the power supply to the ID Controller, allow at least 1 second to elapse before performing control.

Storage

Store the product at a location where:

- It is not exposed to corrosive gases, dust, metal chips, or salt.
- The ambient storage temperature is within the range stipulated in the specifications.
- There are no sudden variations in temperature (no condensation).
- The ambient storage humidity is within the range stipulated in the specifications.
- No vibration or shock exceeding the values stipulated in the specifications is transmitted directly to the body of the product.
- It is not subject to splashing water, oil, or chemical substances.

Cleaning

Thinners, benzine, acetone, and kerosine may have adverse effects on resin parts and the case coating. Check the resistance to chemicals in the user's manual and do not use chemicals that may affect the product.

Dimensions

Tolerance class IT16 applies to dimensions in this datasheet unless otherwise specified.

RF Tag

V680-D1KP52MT/-D2KF52M

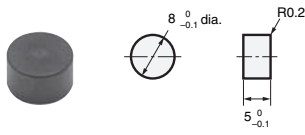

| | |
|---------------|-------------|
| Case material | PPS resin |
| Filling | Epoxy resin |

V680-D1KP53M

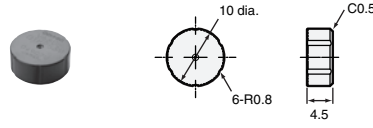

| | |
|---------------|-------------|
| Case material | PPS resin |
| Filling | Epoxy resin |

V680-D1KP54T

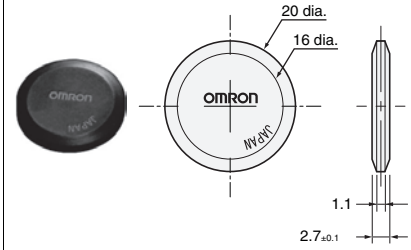

| | |
|---------------|-----------|
| Case material | PPS resin |
|---------------|-----------|

V680-D1KP66T/-D1KP66MT

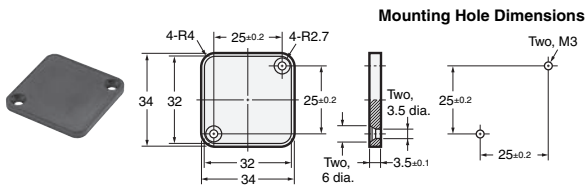

| | |
|---------------|-----------|
| Case material | PPS resin |
|---------------|-----------|

V680-D1KP66T-SP

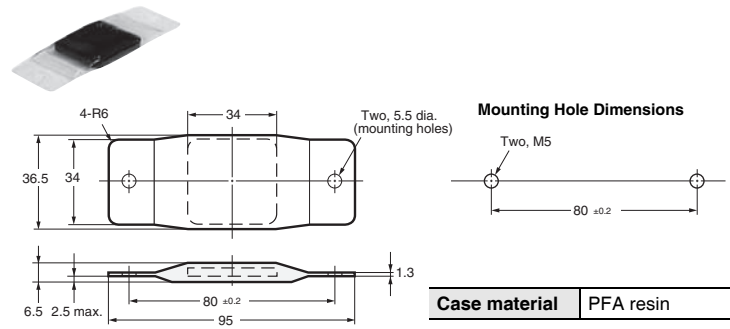

| | |
|---------------|-----------|
| Case material | PFA resin |
|---------------|-----------|

V680S-D2KF67/-D2KF67M
V680S-D8KF67/-D8KF67M

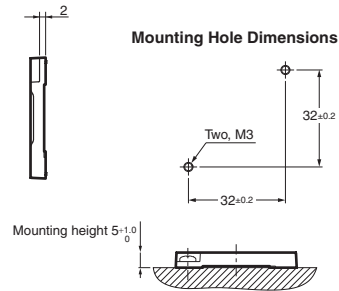
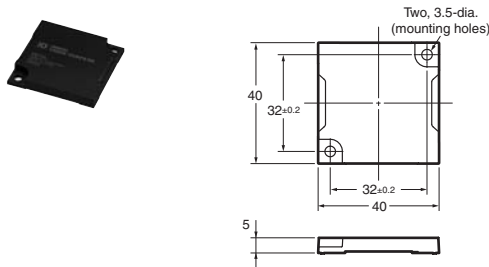

| | |
|---------------|-----------|
| Case material | PPS resin |
|---------------|-----------|

V680S-D2KF68/-D2KF68M
V680S-D8KF68/-D8KF68M

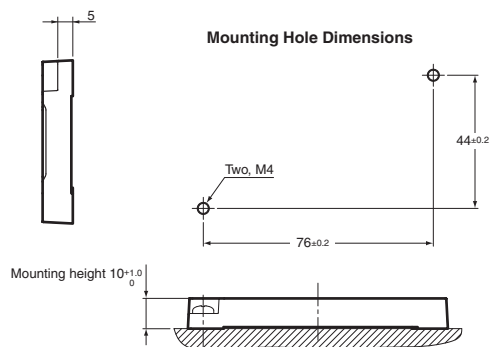
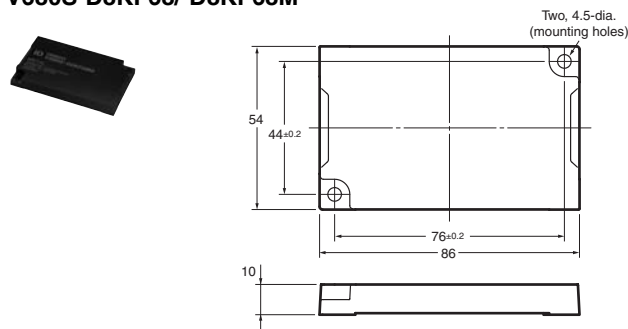

| | |
|---------------|-----------|
| Case material | PPS resin |
|---------------|-----------|

V680 Series

V680-D1KP58HTN

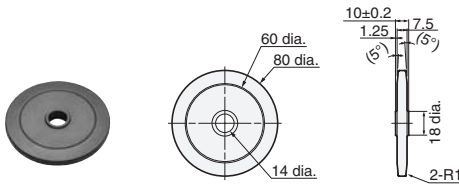

| | |
|----------------|-----------|
| Coating | PPS resin |
|----------------|-----------|

V680-D1KP52M-BT01 V680-D2KF52M-BT01

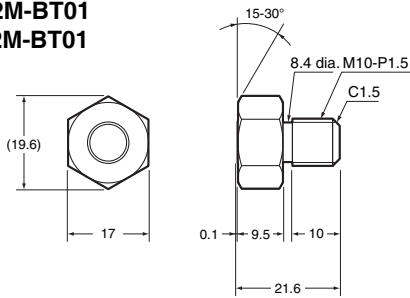

V680-D1KP52M-BT11 V680-D2KF52M-BT11

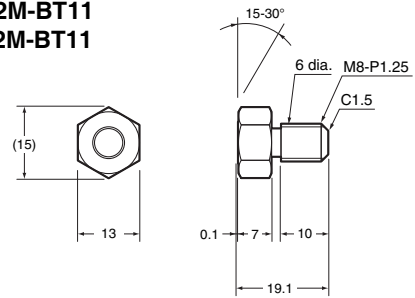

Antenna with Detachable Amplifier Unit

V680-HS52-W

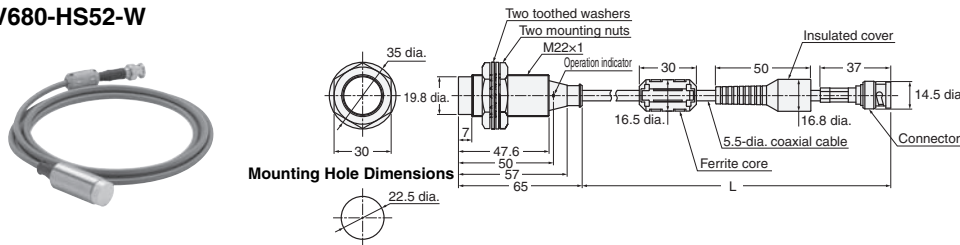

| Cable length | L dimension |
|------------------------------|---------------------------------------|
| 2 m | 2,000 ⁺¹⁰⁰ ₋₅₀ |
| 12.5 m | 12,500 ⁺²⁰⁰ ₋₅₀ |
| Case material | Brass |
| Communication surface | ABS resin |
| Filling | Epoxy resin |
| Cable | PVC |

V680-HS52-R

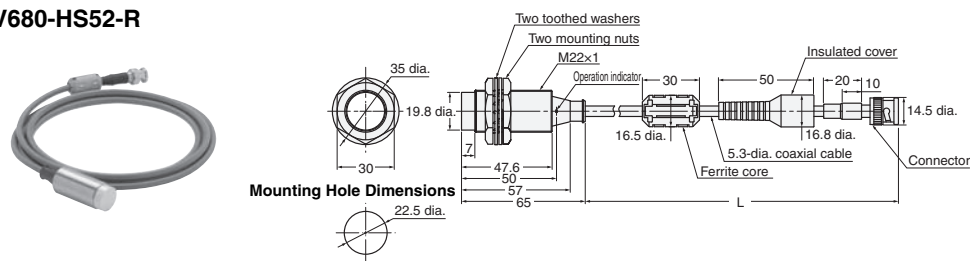

| Cable length | L dimension |
|------------------------------|---------------------------------------|
| 2 m | 2,000 ⁺¹⁰⁰ ₋₅₀ |
| 12.5 m | 12,500 ⁺²⁰⁰ ₋₅₀ |
| Case material | Brass |
| Communication surface | ABS resin |
| Filling | Epoxy resin |
| Cable | PVC |

V680-HS51

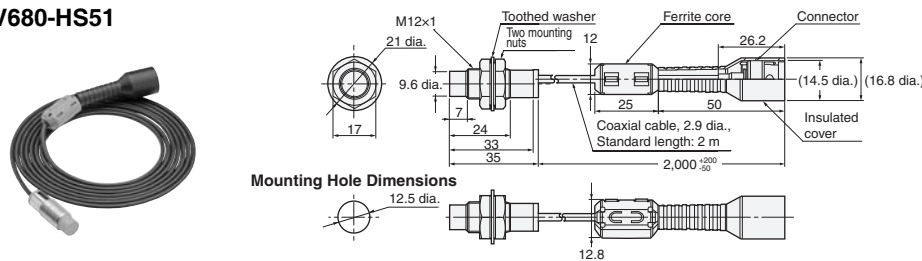

| | |
|------------------------------|-------------|
| Case material | Brass |
| Communication surface | ABS resin |
| Filling | Epoxy resin |
| Cable | PVC |

V680-HS63-W

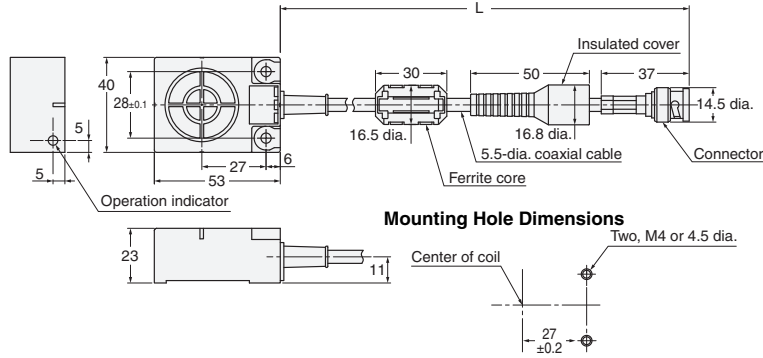

| Cable length | L dimension |
|----------------------|---------------------------------------|
| 2 m | 2,000 ⁺¹⁰⁰ ₋₅₀ |
| 12.5 m | 12,500 ⁺²⁰⁰ ₋₅₀ |
| Case material | ABS resin |
| Filling | Epoxy resin |
| Cable | PVC |

V680-HS63-R

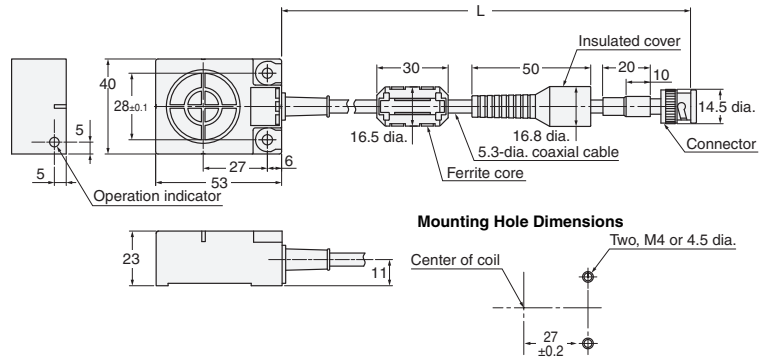

| Cable length | L dimension |
|----------------------|---------------------------------------|
| 2 m | 2,000 ⁺¹⁰⁰ ₋₅₀ |
| 12.5 m | 12,500 ⁺²⁰⁰ ₋₅₀ |
| Case material | ABS resin |
| Filling | Epoxy resin |
| Cable | PVC |

V680-HS65-W

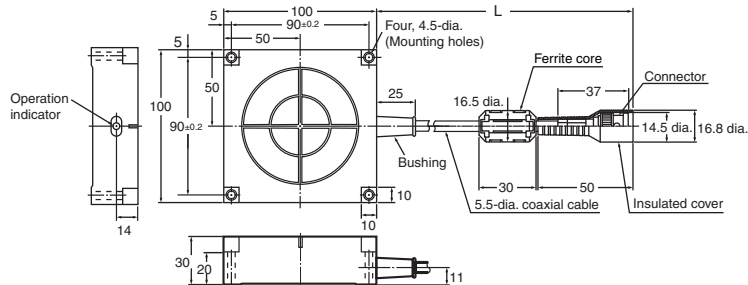

| Cable length | L dimension |
|----------------------|---------------------------------------|
| 2 m | 2,000 ⁺¹⁰⁰ ₋₅₀ |
| 12.5 m | 12,500 ⁺²⁰⁰ ₋₅₀ |
| Case material | ABS resin |
| Filling | Epoxy resin |
| Cable | PVC (gray) |

V680-HS65-R

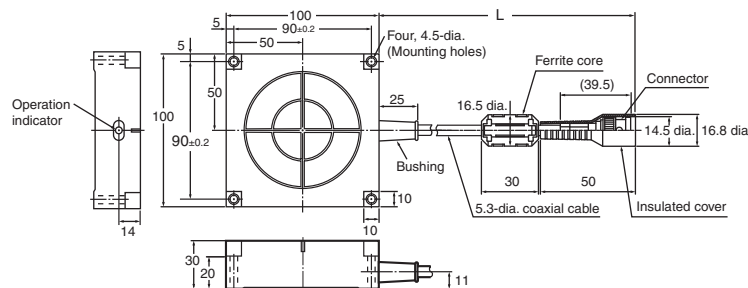

| Cable length | L dimension |
|----------------------|---------------------------------------|
| 2 m | 2,000 ⁺¹⁰⁰ ₋₅₀ |
| 12.5 m | 12,500 ⁺²⁰⁰ ₋₅₀ |
| Case material | ABS resin |
| Filling | Epoxy resin |
| Cable | PVC (black) |

V680 Series

Antenna with Built-in Amplifier Unit

V680-H01-V2

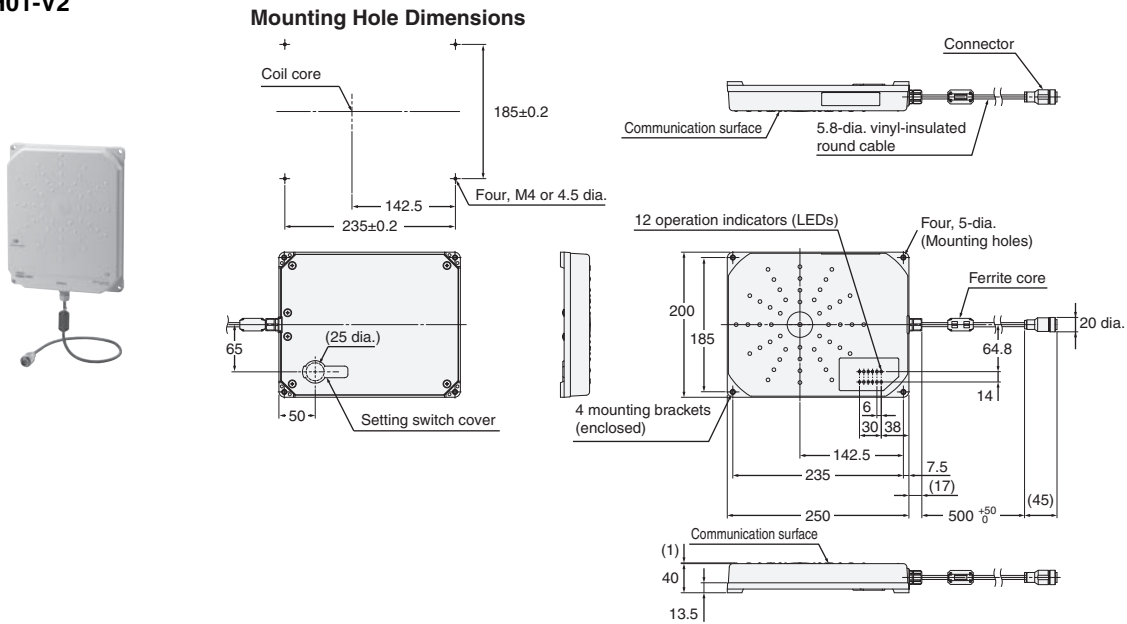

| | |
|----------------------|--------------|
| Case material | PC/ASA resin |
| Filling | Aluminum |
| Cable | PVC |

Amplifier Unit

V680-HA63A/-HA63B

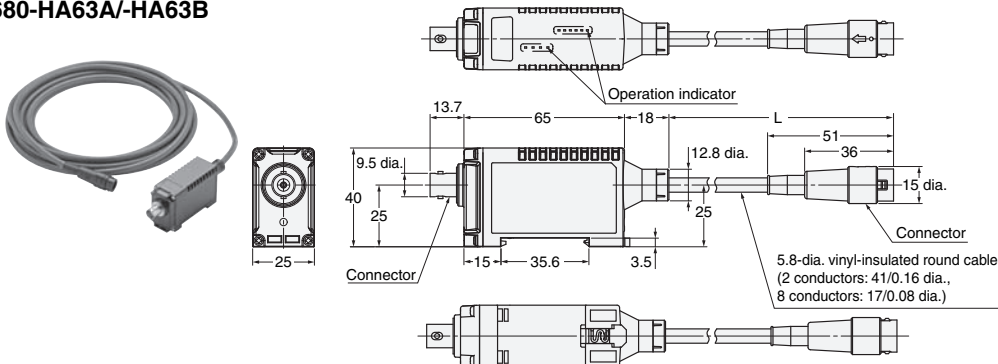

| Cable length | L dimension |
|--------------|--|
| 0.5 m | 500 ⁺¹⁰⁰ / ₋₅₀ |
| 5 m | 5,000 ⁺¹⁰⁰ / ₋₅₀ |
| 10 m | 10,000 ⁺²⁰⁰ / ₋₁₀₀ |

| | |
|----------------------|-------------|
| Case material | PC resin |
| Filling | Epoxy resin |
| Cable | PVC |

ID Controller

V680-CA5D01-V2/-CA5D02-V2



Mounting Hole Dimensions

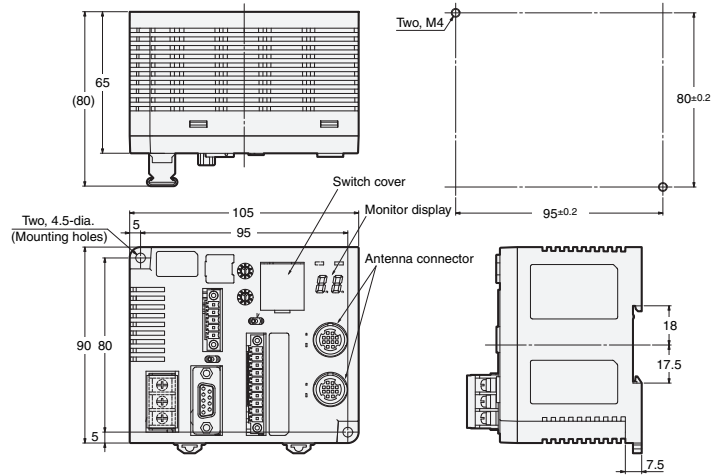

RFID Units

NX-V680C1 (One-channel)

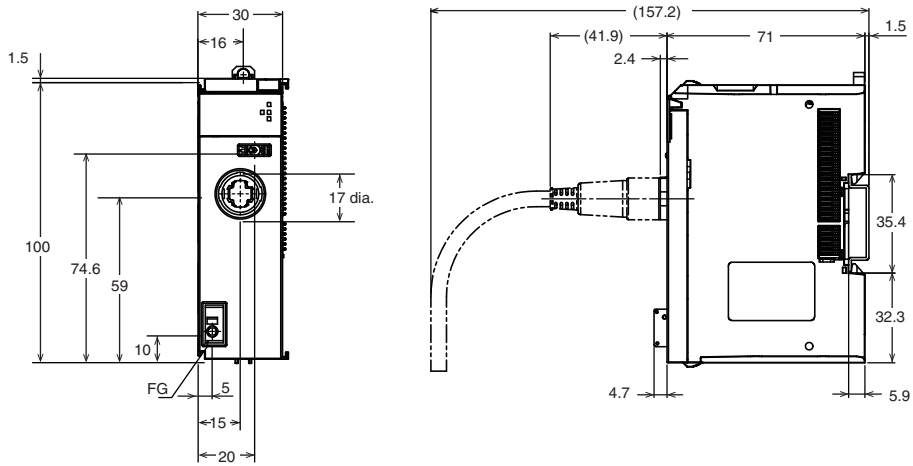

NX-V680C2 (Two-channels)

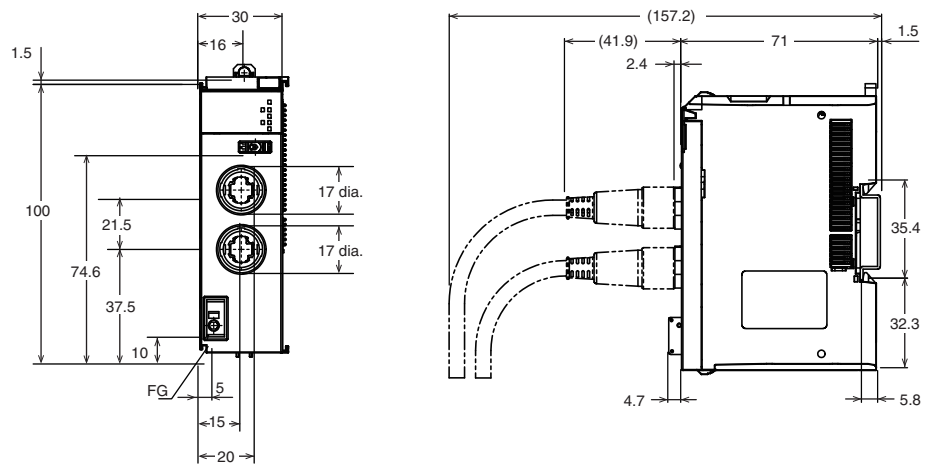

V680 Series

ID Sensor Units

CJ1W-V680C11

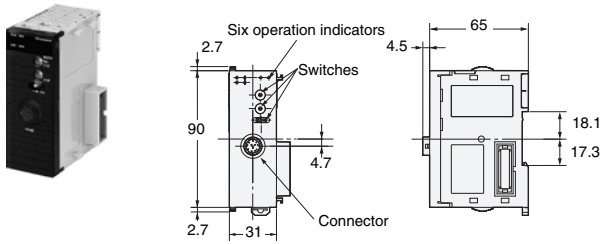

CS1W-V680C11

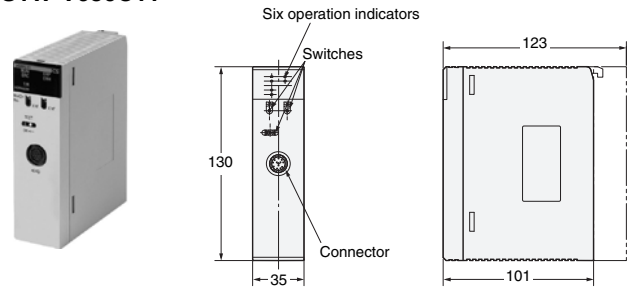

CJ1W-V680C12

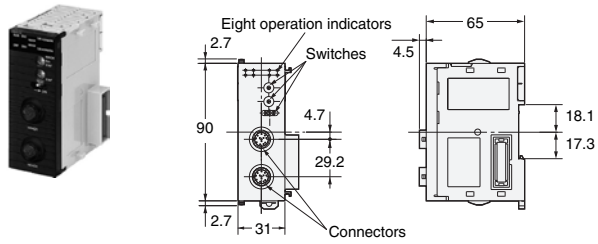

CS1W-V680C12

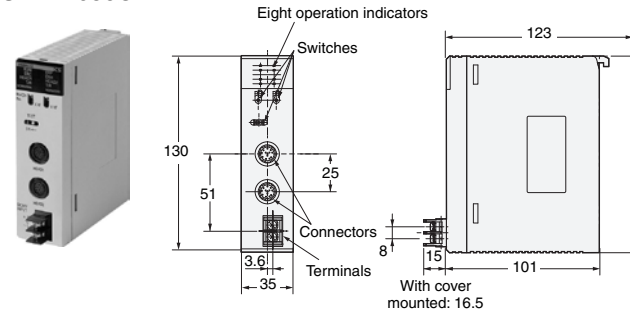

Amplifier-integrated Controller (DeviceNet ID Slave/PROFIBUS ID Slave)

V680-HAM42-DRT

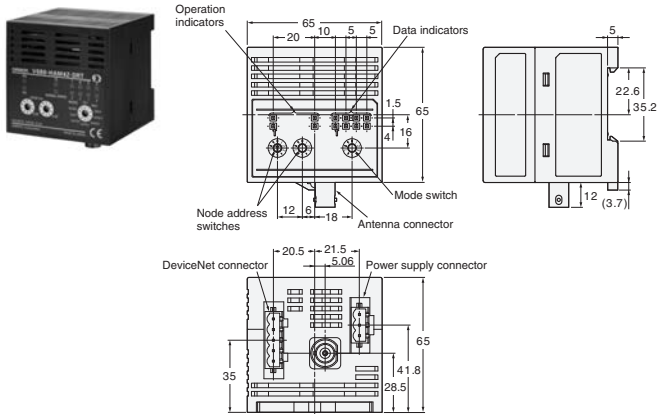

Case material PC+ABS resin

V680-HAM42-PRT

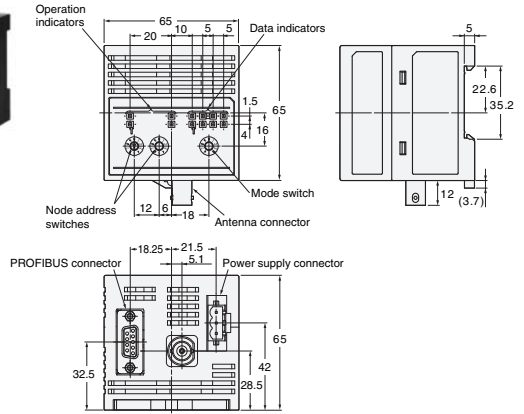

Case material PC+ABS resin

Amplifier-integrated Controllers (ID Flag Sensors)

V680-HAM91/-HAM81

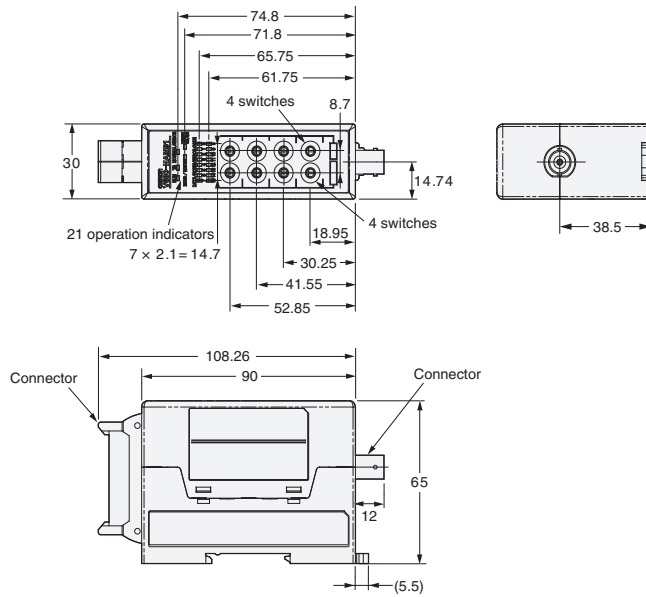

| | |
|---------------|--------------|
| Case material | PC+ABS resin |
|---------------|--------------|

Handheld Reader Writer

V680-CHUD

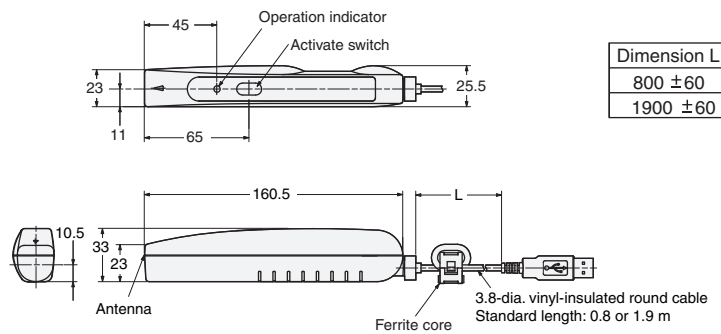

| | |
|---------------|-----------|
| Case material | ABS resin |
| Cable | PVC |

V680-CH1D

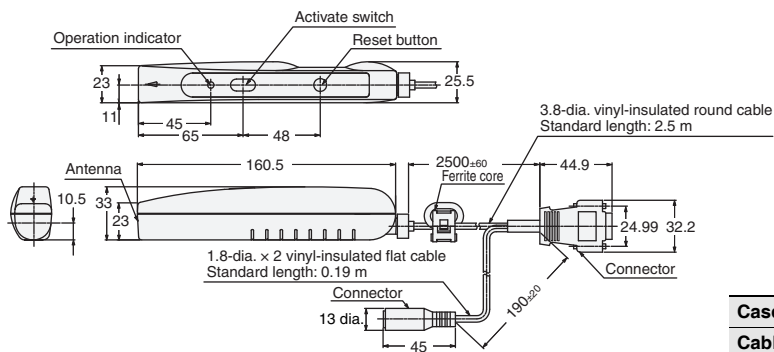

| | |
|---------------|-----------|
| Case material | ABS resin |
| Cable | PVC |

V680-CH1D-PSI

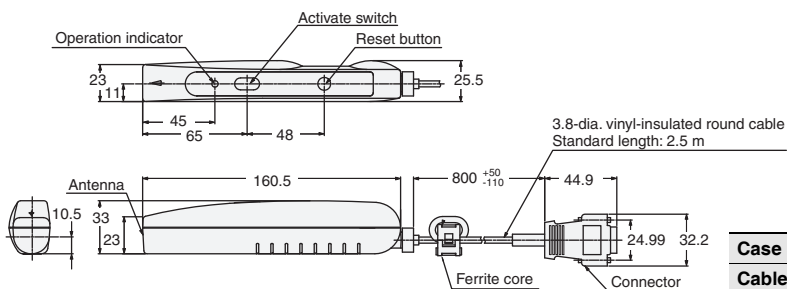

| | |
|---------------|-----------|
| Case material | ABS resin |
| Cable | PVC |

V680 Series

Interface Cables (Sold Separately)

V680-A60 2M/5M/10M

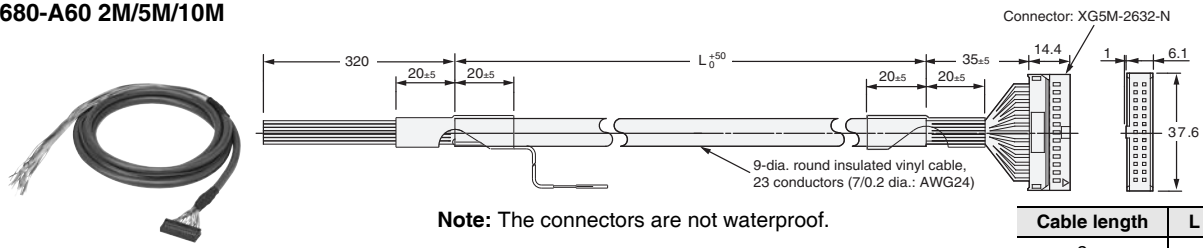

| Cable length | L dimension |
|--------------|-------------|
| 2 m | 2,000 |
| 5 m | 5,000 |
| 10 m | 10,000 |

AC Adapter

V600-A22

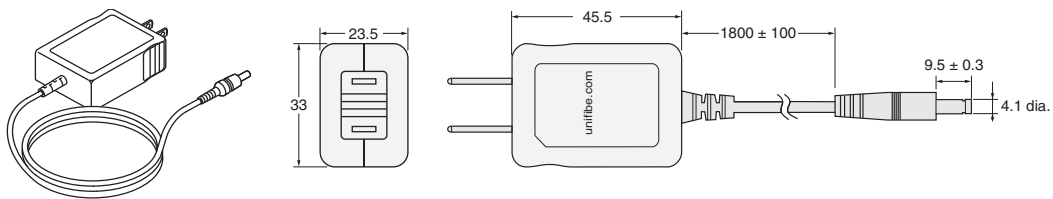

Accessories

V680-D1KP66T Attachments

V600-A86

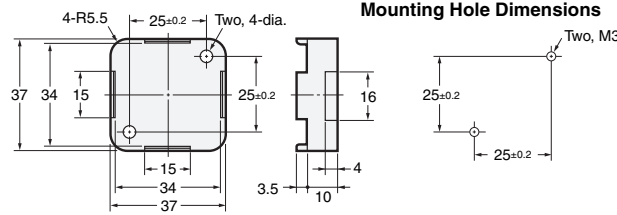

| | |
|---------------|-----------|
| Case material | PPS resin |
|---------------|-----------|

V680-D8KF68/-D32KF68 Attachments

V680-A81

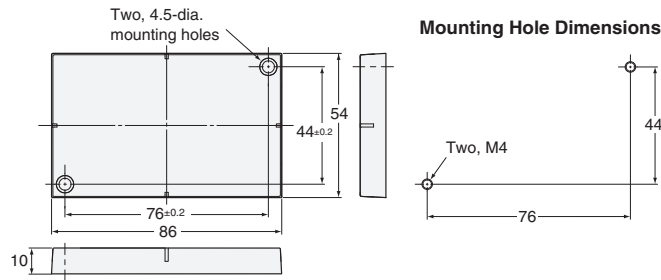

| | |
|---------------|-------------|
| Case material | PBT resin |
| Filling | Epoxy resin |

V680-D1KP58HTN Attachments

V680-A80

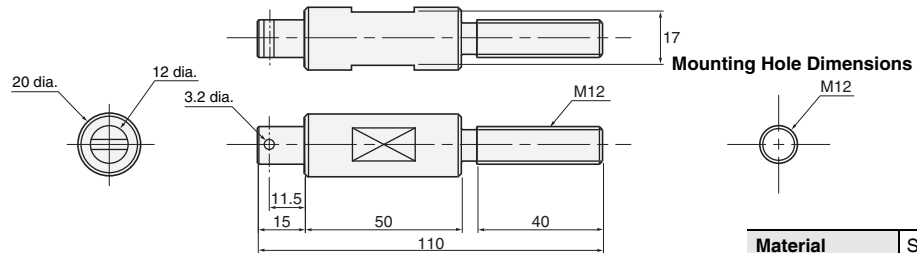

| | |
|----------|-----------------|
| Material | Stainless steel |
|----------|-----------------|

V680-D1KP54T Attachments

V700-A80

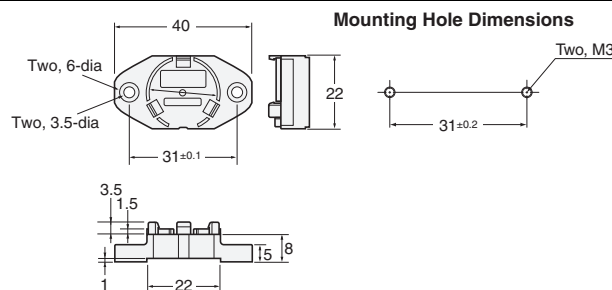

| | |
|----------|-----------|
| Material | PPS resin |
|----------|-----------|

Amplifier Unit Special Extension Cable

V700-A40 2M

V700-A41 3M

V700-A42 5M

V700-A43 10M

V700-A44 20M

V700-A45 30M

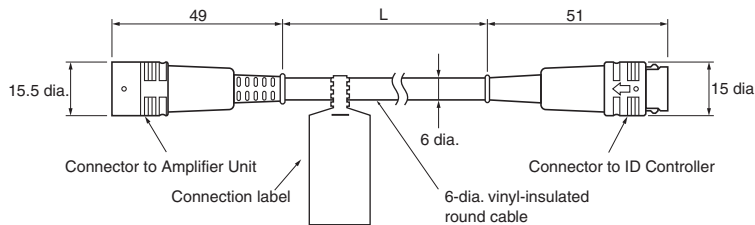

| Cable length | L dimension |
|--------------|-------------|
| 2 m | 2,000±100 |
| 3 m | 3,000±100 |
| 5 m | 5,000±100 |
| 10 m | 10,000±100 |
| 20 m | 20,000±100 |
| 30 m | 30,000±100 |
| Material | PVC |

V680-H01 Special Cables

V700-A40-W 2M

V700-A40-W 5M

V700-A40-W 10M

V700-A40-W 20M

V700-A40-W 30M

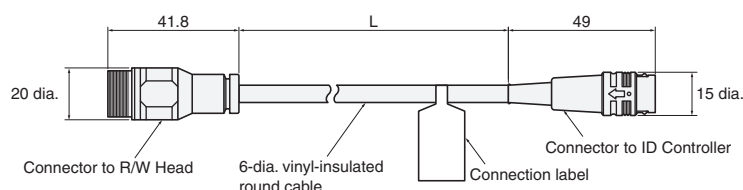

| Cable length | L dimension |
|--------------|-------------|
| 2 m | 2,000±100 |
| 5 m | 5,000±100 |
| 10 m | 10,000±100 |
| 20 m | 20,000±100 |
| 30 m | 30,000±100 |
| Material | PVC |

V680 Series

Related Manuals

| English Man.No. | Japanese Man.No. | Model | Name |
|-----------------|------------------|--|--|
| Z248 | SCHI-707 | V680-HA63B/HS5□/HS6□/H01-V2/D2KF□□(M)(-BT□1), V680S-D2KF□□(M)/D8KF□□(M) | V680 series Amplifiers/Antennas/RF Tags (FRAM) User's Manual |
| Z262 | SCHI-709 | V680-HA63A/HS5□/HS□/H01-V2/D1KP□□M(T)(-BT□1)/D1KP□□T(-SP)/D1KP58HT | V680 series Amplifiers/Antennas/RF Tags (EEPROM) User's Manual |
| Z249 | SCHI-708 | V680-CA5D01-V2/CA5D02-V2 | V680 series ID Controller User's Manual |
| Z401 | SDGR-717 | NX-V680C□ | NX-series RFID Units User's Manual |
| W609 | SBCA-473 | SYSMAC-XR019 | Sysmac Library User's Manual for RFID Communications Library |
| Z317 | SDGR-703 | CJ1W-V680C11/-V680C12 | CJ series ID Sensor Units Operation Manual (NJ-series) |
| Z271 | SCHI-711 | CS1W-V680C11/-V680C12, CJ1W-V680C11/-V680C12 | CJ/CS series ID Sensor Units User's Manual |
| Z278 | SCHI-714 | V680-HAM42-DRT | V680 series DeviceNet ID Slave User's Manual |
| Z320 | SDGR-704 | V680-HAM42-PRT/HS63-W/HS65-W/D1KP66(M)T/D1KP58HTN, V680S-D2KF□□(M)/D8KF□□(M) | V680 series PROFIBUS ID Slave User's Manual |
| Z268 | SCHI-710 | V680-HAM42-FRT | V680 series FL Remote ID User's Manual |
| Z279 | SCHI-715 | V680-HAM91/HAM81 | V680 series ID Flag Sensors User's Manual |
| Z272 | SCHI-712 | V680-CHUD/CH1D/CH1D-PSI | V680 series Hand-held Reader Writer User's Manual |
| Z339 | SDGR-709 | V680S-HMD64-ETN/HMD66-ETN | V680S series User's Manual |

- Sysmac is a trademark or registered trademark of OMRON Corporation in Japan and other countries for OMRON factory automation products.
- DeviceNet™ is a trademark of ODVA.
- Other company names and product names in this document are the trademarks or registered trademarks of their respective companies.

Terms and Conditions Agreement

Read and understand this catalog.

Please read and understand this catalog before purchasing the products. Please consult your OMRON representative if you have any questions or comments.

Warranties.

- (a) Exclusive Warranty. Omron's exclusive warranty is that the Products will be free from defects in materials and workmanship for a period of twelve months from the date of sale by Omron (or such other period expressed in writing by Omron). Omron disclaims all other warranties, express or implied.
- (b) Limitations. OMRON MAKES NO WARRANTY OR REPRESENTATION, EXPRESS OR IMPLIED, ABOUT NON-INFRINGEMENT, MERCHANTABILITY OR FITNESS FOR A PARTICULAR PURPOSE OF THE PRODUCTS. BUYER ACKNOWLEDGES THAT IT ALONE HAS DETERMINED THAT THE PRODUCTS WILL SUITABLY MEET THE REQUIREMENTS OF THEIR INTENDED USE.

Omron further disclaims all warranties and responsibility of any type for claims or expenses based on infringement by the Products or otherwise of any intellectual property right. (c) Buyer Remedy. Omron's sole obligation hereunder shall be, at Omron's election, to (i) replace (in the form originally shipped with Buyer responsible for labor charges for removal or replacement thereof) the non-complying Product, (ii) repair the non-complying Product, or (iii) repay or credit Buyer an amount equal to the purchase price of the non-complying Product; provided that in no event shall Omron be responsible for warranty, repair, indemnity or any other claims or expenses regarding the Products unless Omron's analysis confirms that the Products were properly handled, stored, installed and maintained and not subject to contamination, abuse, misuse or inappropriate modification. Return of any Products by Buyer must be approved in writing by Omron before shipment. Omron Companies shall not be liable for the suitability or unsuitability or the results from the use of Products in combination with any electrical or electronic components, circuits, system assemblies or any other materials or substances or environments. Any advice, recommendations or information given orally or in writing, are not to be construed as an amendment or addition to the above warranty.

See <http://www.omron.com/global/> or contact your Omron representative for published information.

Limitation on Liability; Etc.

OMRON COMPANIES SHALL NOT BE LIABLE FOR SPECIAL, INDIRECT, INCIDENTAL, OR CONSEQUENTIAL DAMAGES, LOSS OF PROFITS OR PRODUCTION OR COMMERCIAL LOSS IN ANY WAY CONNECTED WITH THE PRODUCTS, WHETHER SUCH CLAIM IS BASED IN CONTRACT, WARRANTY, NEGLIGENCE OR STRICT LIABILITY.

Further, in no event shall liability of Omron Companies exceed the individual price of the Product on which liability is asserted.

Suitability of Use.

Omron Companies shall not be responsible for conformity with any standards, codes or regulations which apply to the combination of the Product in the Buyer's application or use of the Product. At Buyer's request, Omron will provide applicable third party certification documents identifying ratings and limitations of use which apply to the Product. This information by itself is not sufficient for a complete determination of the suitability of the Product in combination with the end product, machine, system, or other application or use. Buyer shall be solely responsible for determining appropriateness of the particular Product with respect to Buyer's application, product or system. Buyer shall take application responsibility in all cases.

NEVER USE THE PRODUCT FOR AN APPLICATION INVOLVING SERIOUS RISK TO LIFE OR PROPERTY OR IN LARGE QUANTITIES WITHOUT ENSURING THAT THE SYSTEM AS A WHOLE HAS BEEN DESIGNED TO ADDRESS THE RISKS, AND THAT THE OMRON PRODUCT(S) IS PROPERLY RATED AND INSTALLED FOR THE INTENDED USE WITHIN THE OVERALL EQUIPMENT OR SYSTEM.

Programmable Products.

Omron Companies shall not be responsible for the user's programming of a programmable Product, or any consequence thereof.

Performance Data.

Data presented in Omron Company websites, catalogs and other materials is provided as a guide for the user in determining suitability and does not constitute a warranty. It may represent the result of Omron's test conditions, and the user must correlate it to actual application requirements. Actual performance is subject to the Omron's Warranty and Limitations of Liability.

Change in Specifications.

Product specifications and accessories may be changed at any time based on improvements and other reasons. It is our practice to change part numbers when published ratings or features are changed, or when significant construction changes are made. However, some specifications of the Product may be changed without any notice. When in doubt, special part numbers may be assigned to fix or establish key specifications for your application. Please consult with your Omron's representative at any time to confirm actual specifications of purchased Product.

Errors and Omissions.

Information presented by Omron Companies has been checked and is believed to be accurate; however, no responsibility is assumed for clerical, typographical or proofreading errors or omissions.

OMRON Corporation Industrial Automation Company

Kyoto, JAPAN

Contact: www.ia.omron.com

Regional Headquarters

OMRON EUROPE B.V.

Wegalaan 67-69, 2132 JD Hoofddorp
The Netherlands

Tel: (31)2356-81-300/Fax: (31)2356-81-388

OMRON ELECTRONICS LLC

2895 Greenspoint Parkway, Suite 200
Hoffman Estates, IL 60169 U.S.A.

Tel: (1) 847-843-7900/Fax: (1) 847-843-7787

OMRON ASIA PACIFIC PTE. LTD.

No. 438A Alexandra Road # 05-05/08 (Lobby 2),
Alexandra Technopark,
Singapore 119967

Tel: (65) 6835-3011/Fax: (65) 6835-2711

OMRON (CHINA) CO., LTD.

Room 2211, Bank of China Tower,
200 Yin Cheng Zhong Road,
PuDong New Area, Shanghai, 200120, China

Tel: (86) 21-5037-2222/Fax: (86) 21-5037-2200

Authorized Distributor:

© OMRON Corporation 2018 All Rights Reserved.
In the interest of product improvement,
specifications are subject to change without notice.

CSM_1_19_1018

Cat. No. Q267-E1-01

0918 (0918) (O)

Mouser Electronics

Authorized Distributor

Click to View Pricing, Inventory, Delivery & Lifecycle Information:

Omron:

[V680S-A40 50M](#) [V680S-HMD66-ETN](#) [V680S-A40 10M](#) [V680S-HMD64-ETN](#) [V680S-A41 10M](#) [V680S-A41 5M](#)
[V680S-A40 20M](#) [V680S-A41 2M](#) [V680S-D2KF68](#) [V680S-HMD63-EIP](#)

Компания «Океан Электроники» предлагает заключение долгосрочных отношений при поставках импортных электронных компонентов на взаимовыгодных условиях!

Наши преимущества:

- Поставка оригинальных импортных электронных компонентов напрямую с производств Америки, Европы и Азии, а так же с крупнейших складов мира;
- Широкая линейка поставок активных и пассивных импортных электронных компонентов (более 30 млн. наименований);
- Поставка сложных, дефицитных, либо снятых с производства позиций;
- Оперативные сроки поставки под заказ (от 5 рабочих дней);
- Экспресс доставка в любую точку России;
- Помощь Конструкторского Отдела и консультации квалифицированных инженеров;
- Техническая поддержка проекта, помощь в подборе аналогов, поставка прототипов;
- Поставка электронных компонентов под контролем ВП;
- Система менеджмента качества сертифицирована по Международному стандарту ISO 9001;
- При необходимости вся продукция военного и аэрокосмического назначения проходит испытания и сертификацию в лаборатории (по согласованию с заказчиком);
- Поставка специализированных компонентов военного и аэрокосмического уровня качества (Xilinx, Altera, Analog Devices, Intersil, Interpoint, Microsemi, Actel, Aeroflex, Peregrine, VPT, Syfer, Eurofarad, Texas Instruments, MS Kennedy, Miteq, Cobham, E2V, MA-COM, Hittite, Mini-Circuits, General Dynamics и др.);

Компания «Океан Электроники» является официальным дистрибьютором и эксклюзивным представителем в России одного из крупнейших производителей разъемов военного и аэрокосмического назначения «JONHON», а так же официальным дистрибьютором и эксклюзивным представителем в России производителя высокотехнологичных и надежных решений для передачи СВЧ сигналов «FORSTAR».



JONHON

«JONHON» (основан в 1970 г.)

Разъемы специального, военного и аэрокосмического назначения:

(Применяются в военной, авиационной, аэрокосмической, морской, железнодорожной, горно- и нефтедобывающей отраслях промышленности)

«FORSTAR» (основан в 1998 г.)

ВЧ соединители, коаксиальные кабели, кабельные сборки и микроволновые компоненты:

(Применяются в телекоммуникациях гражданского и специального назначения, в средствах связи, РЛС, а так же военной, авиационной и аэрокосмической отраслях промышленности).



Телефон: 8 (812) 309-75-97 (многоканальный)

Факс: 8 (812) 320-03-32

Электронная почта: ocean@oceanchips.ru

Web: <http://oceanchips.ru/>

Адрес: 198099, г. Санкт-Петербург, ул. Калинина, д. 2, корп. 4, лит. А