

The logo for Microtips Technology features a stylized graphic of three slanted bars in red, green, and blue on the left, followed by the word "Microtips" in a large, bold, serif font. Below this, a thick horizontal line separates the word "TECHNOLOGY" from the rest of the page, written in a smaller, bold, serif font.

Microtips

TECHNOLOGY

Model No: T VÖ€FHEÓÔÚ€GÙØ€

Approved By	

Tel: 1 (888) 499-8477

Fax: (407) 273-0771

E-mail: mtusainfo@microtipsusa.com

Web: www.microtipsusa.com

Record of Revision

Date	Revision No.	Summary
2019-02-26	1.0	Rev 1.0 was issued

1. Scope

This data sheet is to introduce the specification of MTD0130BCP02SF-1 active matrix TFT module. It is composed of a color TFT-LCD panel, driver IC, FPC and a backlight unit. The 1.3" display area contains 240(RGB) x 240 pixels.

2. Application

Digital equipments which need color display, mobile navigator/video systems.

3. General Information

Item	Contents	Unit
Size	1.3	inch
Resolution	240(RGB) x 240	/
Interface	SPI	/
Technology type	IPS	/
Pixel pitch	0.135 x 0.135	mm
Pixel Configuration	RGB stripes	
Outline Dimension (W x H x D)	35.50 x 38.23 x 1.40	mm
Active Area	32.40 x 32.40	mm
Display Mode	Transmissive, Normally Black	/
Backlight Type	LED	/
Viewing Direction	ALL	/
Driver IC	ST7789V	
Weight	TBD	g

4. Outline Drawing

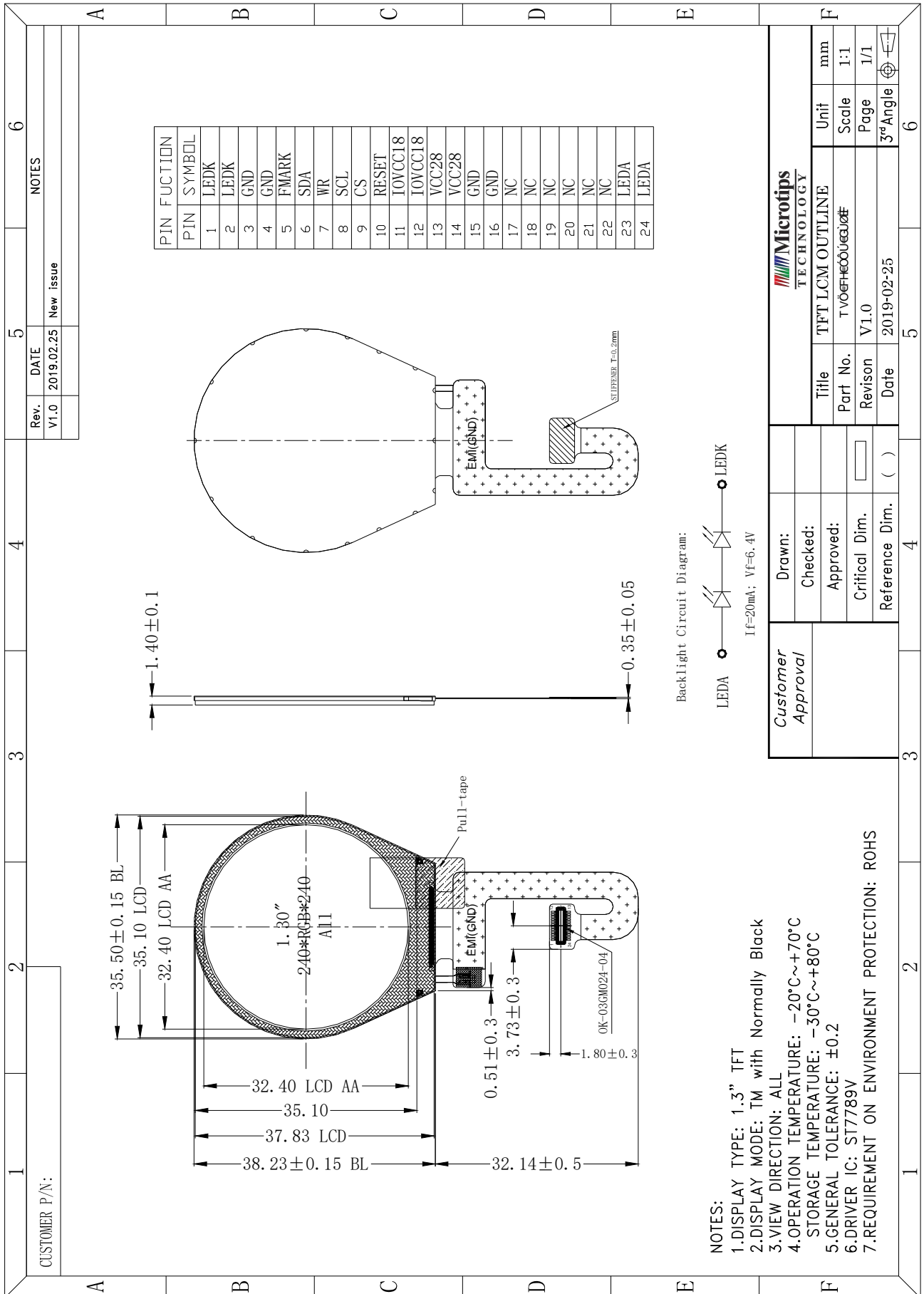

5. Interface signals

Pin No	Symbol	Function
1	LEDK	Power for LED Backlight Cathode
2	LEDK	Power for LED Backlight Cathode
3	GND	Power ground
4	GND	Power ground
5	FMARK	Tearing effect signal pin
6	SDA	Serial data input pin
7	WR	Second data lane in 2 data lane pin
8	SCL	Serial interface clock pin
9	CS	Chip select
10	RESET	Reset pin
11	IOVCC18	A power supply for the internal logic (1.8V)
12	IOVCC18	A power supply for the internal logic (1.8V)
13	VCC28	A power supply for the internal logic (2.8V)
14	VCC28	A power supply for the internal logic (2.8V)
15	GND	Power ground
16	GND	Power ground
17	NC	No connection
18	NC	No connection
19	NC	No connection
20	NC	No connection
21	NC	No connection
22	NC	No connection
23	LEDA	Power for LED Backlight Anode
24	LEDA	Power for LED Backlight Anode

6. Absolute maximum Ratings

6.1. Electrical Absolute max. ratings

Parameter	Symbol	MIN	MAX	Unit	Remark
Power supply for Logic	VCC-VSS	2.4	3.3	V	
Power supply for LCD	VGH-VSS	10	15	V	
Input voltage	VGL	-13	-7.5	V	

6.2. Environment Conditions

Item	Symbol	MIN	MAX	Unit	Remark
Operating Temperature	TOPR	-20	70	°C	
Storage Temperature	TSTG	-30	80	°C	

7. Electrical Specifications

7.1 Electrical characteristics

Ta = 25 °C

Item	Symbol	MIN	TYP	MAX	Unit	Remark
Supply Voltage	VCC	2.6	2.8	3.3	V	
	IOVCC	1.65	1.8	3.3	V	
Input voltage	“H” VIH	0.7*IOVCC	--	IOVCC	V	
	“L” VIL	VSS	--	0.3*IOVCC	V	
Output voltage	“H” VOH	0.8*IOVCC	--	IOVCC	V	
	“L” VOL	VSS	--	0.2*IOVCC	V	

7.2 LED Backlight

Ta=25°C

Item	Symbol	MIN	TYP	MAX	Unit	Remark
Forward Current	IF	-	20	-	mA	
Forward Voltage	VF	5.6	6.4	7	V	If=40mA
LED Life time	-	-	30,000	-	Hrs	Note

Note: The “LED life time” is defined as the module brightness decrease to 50% original brightness at Ta=25°C and IF=20mA. The LED life time could be decreased if operating IF is larger than 20mA.

Backlight Circuit Diagram:

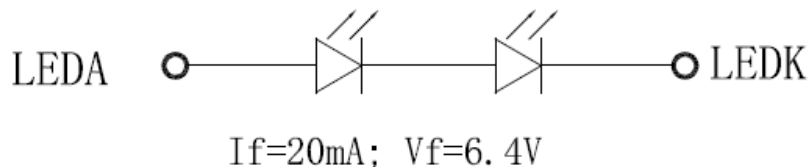

8. Command/AC Timing

8.1 AC Characteristics

8.1.1 Serial Interface Characteristics (3-line serial)

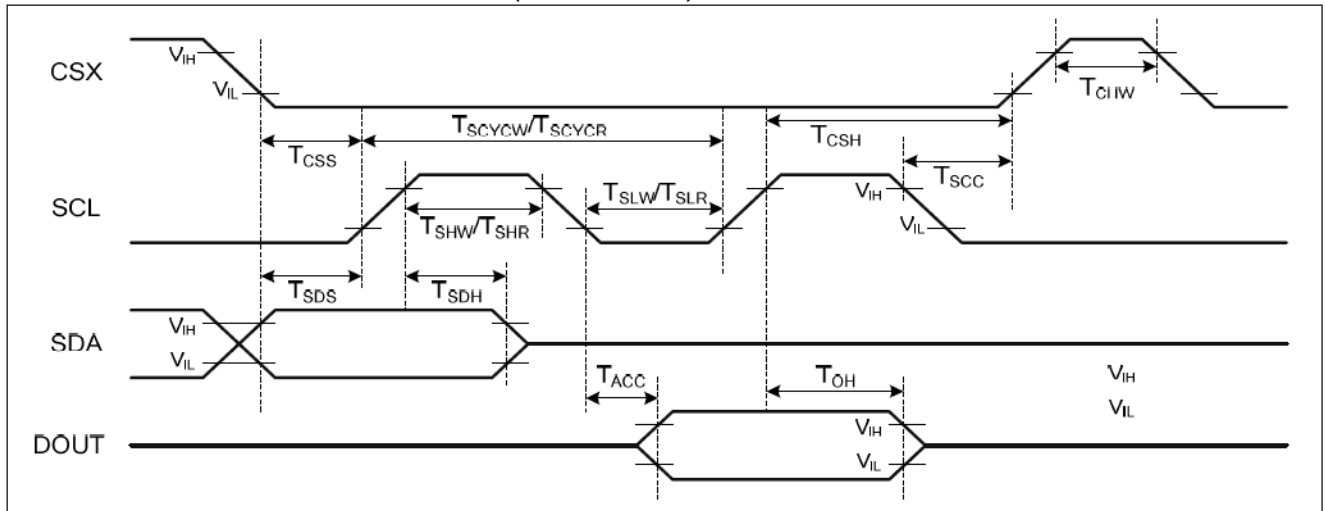

Figure: 3-line serial Interface Timing Characteristics

VDDI=1.65 to 3.3V, VDD=2.4 to 3.3V, AGND=DGND=0V, Ta= -30 to 70 °C

Signal	Symbol	Parameter	Min.	Max.	Unit	Description
CSX	T _{CSS}	Chip select setup time (write)	15	-	ns	
	T _{CSH}	Chip select hold time (write)	15	-	ns	
	T _{CSS}	Chip select setup time (read)	60	-	ns	
	T _{SCC}	Chip select hold time (read)	65	-	ns	
	T _{CHW}	Chip select "H" pulse width	40	-	ns	
SCL	T _{SCYCW}	Serial clock cycle (write)	66	-	ns	
	T _{SHW}	SCL "H" pulse width (write)	15	-	ns	
	T _{SLW}	SCL "L" pulse width (write)	15	-	ns	
	T _{SCYCR}	Serial clock cycle (read)	150	-	ns	
	T _{SHR}	SCL "H" pulse width (read)	60	-	ns	
	T _{SLR}	SCL "L" pulse width (read)	60	-	ns	
SDA (DIN)	T _{SDS}	Data setup time	10	-	ns	
	T _{SDH}	Data hold time	10	-	ns	
DOUT	T _{ACC}	Access time	10	50	ns	For maximum CL=30pF For minimum CL=8pF
	T _{OH}	Output disable time	15	50	ns	

Table: 3-line serial Interface Characteristics

8.1.2 Serial Interface Characteristics (4-line serial)

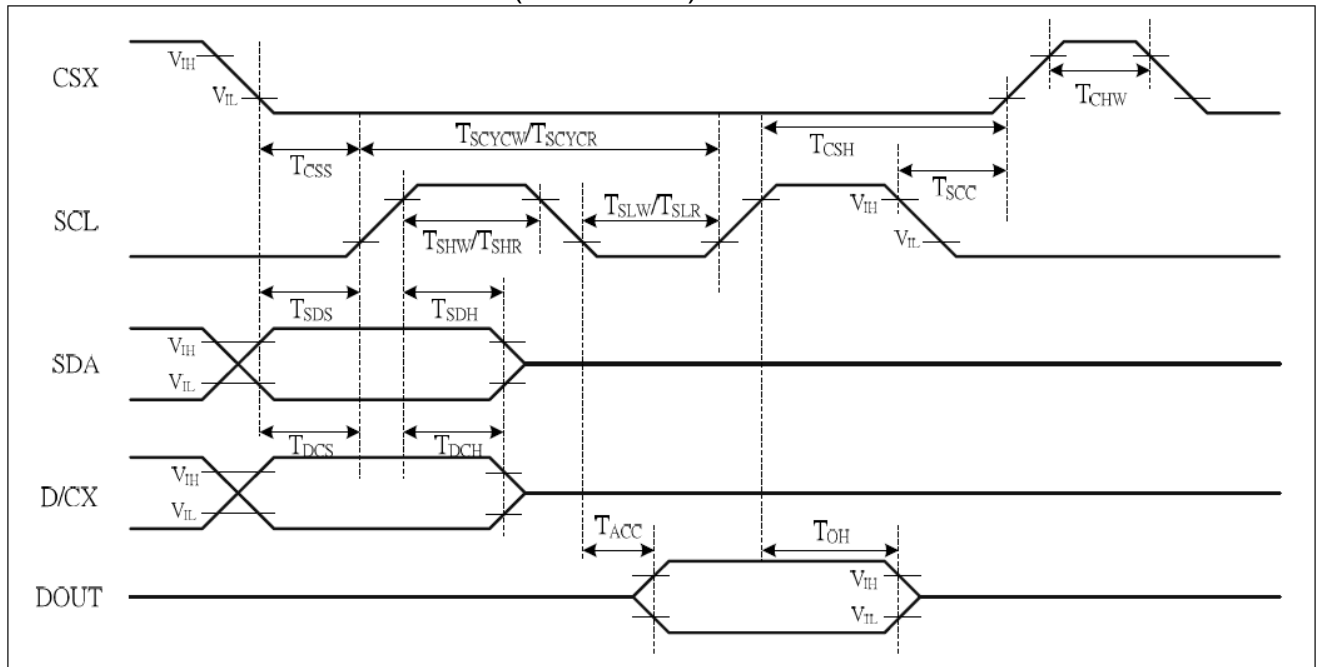

Figure: 4-line serial Interface Timing Characteristics

VDDI=1.65 to 3.3V, VDD=2.4 to 3.3V, AGND=DGND=0V, Ta= -30 to 70°C

Signal	Symbol	Parameter	Min.	Max.	Unit	Description
CSX	T _{css}	Chip select setup time (write)	15	-	ns	
	T _{sch}	Chip select hold time (write)	15	-	ns	
	T _{css}	Chip select setup time (read)	60	-	ns	
	T _{sccl}	Chip select hold time (read)	65	-	ns	
	T _{chw}	Chip select "H" pulse width	40	-	ns	
SCL	T _{scycw}	Serial clock cycle (write)	66	-	ns	-write command & data ram
	T _{shw}	SCL "H" pulse width (write)	15	-	ns	
	T _{slw}	SCL "L" pulse width (write)	15	-	ns	
	T _{scycr}	Serial clock cycle (read)	150	-	ns	-read command & data ram
	T _{shr}	SCL "H" pulse width (read)	60	-	ns	
	T _{slr}	SCL "L" pulse width (read)	60	-	ns	
D/CX	T _{dcs}	D/CX setup time	10	-	ns	
	T _{dch}	D/CX hold time	10	-	ns	
SDA (DIN)	T _{sdh}	Data setup time	10	-	ns	
	T _{sdh}	Data hold time	10	-	ns	
DOUT	T _{acc}	Access time	10	50	ns	For maximum CL=30pF For minimum CL=8pF
	T _{oh}	Output disable time	15	50	ns	

Table: 4-line serial Interface Characteristics

9. Optical Specification

Ta=25°C

Item	Symbol	Condition	Min	Typ.	Max.	Unit	Remark
Contrast Ratio	CR	$\theta=0^\circ$	-	800	-		Note1 Note2
Response Time	Ton/ Toff	25°C	-	30	35	ms	Note1 Note3
View Angles	ΘT	CR ≥ 10	-	80	-	Degree	Note 4
	ΘB		-	80	-		
	ΘL		-	80	-		
	ΘR		-	80	-		
Chromaticity	White	Brightness is on	x	0.308	-		Note5, Note1
			y	0.331	-		
	Red		x	0.641	-		
			y	0.337	-		
	Green		x	0.274	-		
			y	0.560	-		
	Blue		x	0.141	-		
			y	0.113	-		
Luminance	L		160	-	-	cd/m ²	Note1 Note6
Uniformity	U		80	-	-	%	Note1 Note7
NTSC Ratio	S		-	60	-	%	

Note 1: Definition of optical measurement system.

Temperature = 25°C(±3°C)

LED back-light: ON, Environment brightness < 150 lx

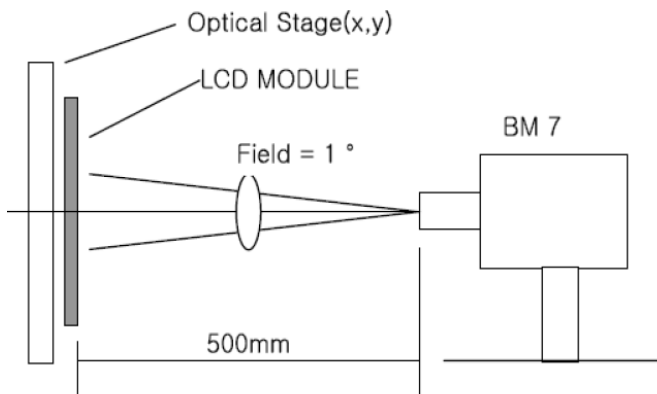

Note 2: Contrast ratio is defined as follow:

$$\text{Contrast Ratio} = \frac{\text{Surface Luminance with all white pixels}}{\text{Surface Luminance with all black pixels}}$$

Note 3: Response time is defined as follow:

Response time is the time required for the display to transition from black to white (Rise Time, T_r) and from white to black (Decay Time, T_f).

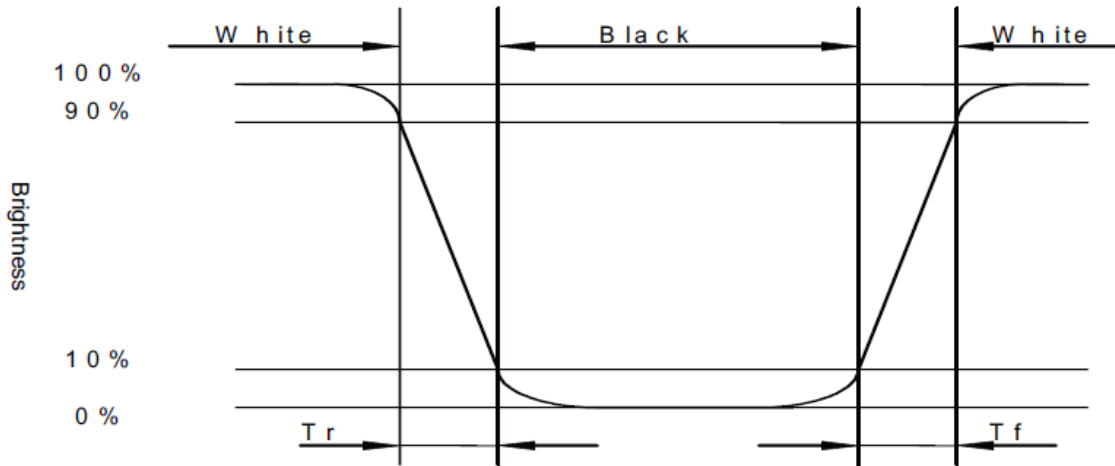

Note 4: Viewing angle range is defined as follow:

Viewing angle is measured at the center point of the LCD.

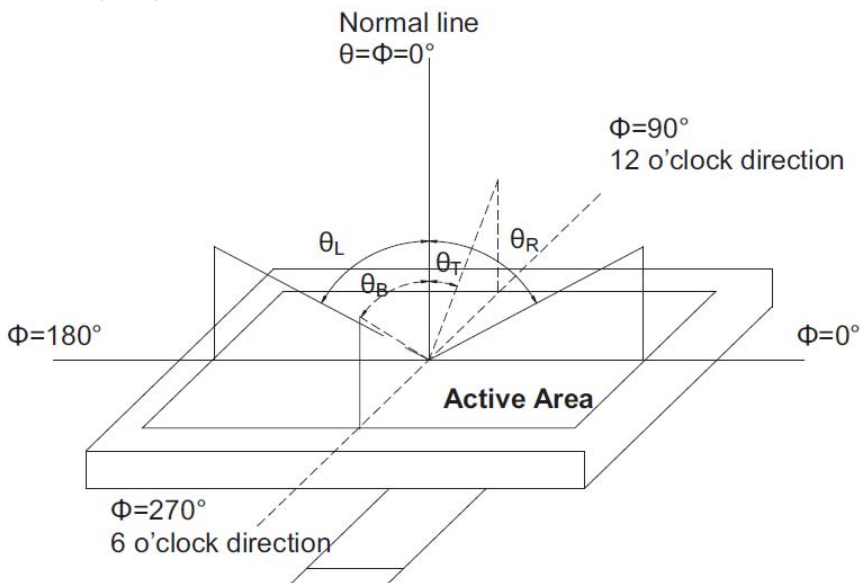

Note 5: Color chromaticity is defined as follow: (CIE1931)

Color coordinates measured at center point of LCD.

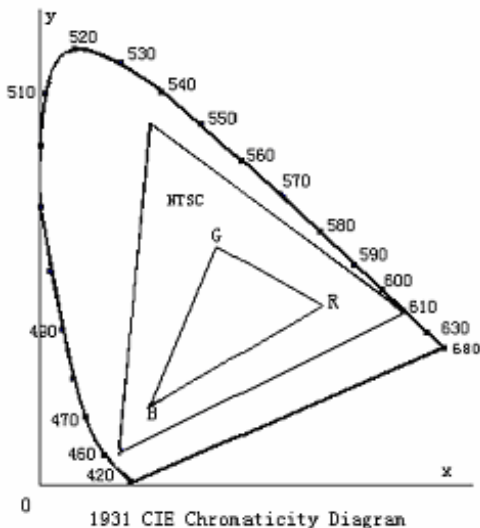

$$S = \frac{\text{area of RGB triangle}}{\text{area of NTSC triangle}} \times 100\%$$

Note 6: Luminance is defined as follow:

Luminance is defined as the brightness of all pixels “White” at the center of display area on optimum contrast.

Note 7: Luminance Uniformity is defined as follow:

Active area is divided into 9 measuring areas (Refer Fig. 2). Every measuring point is placed at the center of each measuring area.

$$\text{Uniformity (U)} = \frac{\text{Minimum Luminance(brightness) in 9 points}}{\text{Maximum Luminance(brightness) in 9 points}}$$

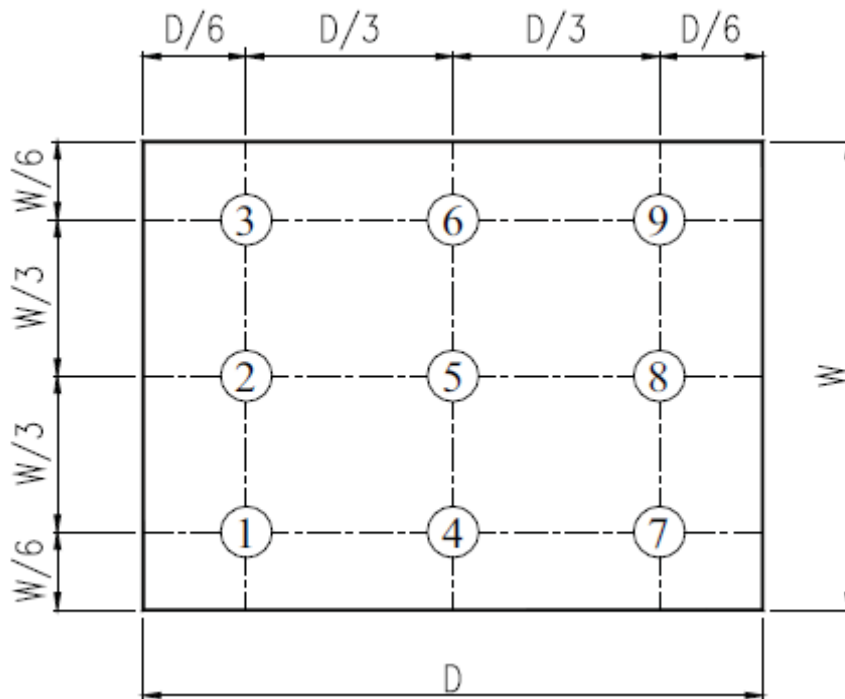

Fig. 2 Definition of uniformity

10. Environmental / Reliability Tests

No	Test Item	Condition	Judgment criteria
1	High Temp Operation	Ts=+70°C, 96hrs	Per table in below
2	Low Temp Operation	Ta=-20°C, 96hrs	Per table in below
3	High Temp Storage	Ta=+80°C, 96hrs	Per table in below
4	Low Temp Storage	Ta=-30°C, 96hrs	Per table in below
5	High Temp & High Humidity Storage	Ta=+40°C, 90% RH 96hours	Per table in below (polarizer discoloration is excluded)
6	Thermal Shock (Non-operation)	-30°C 30 min~+80°C 30 min, Change time:5min, 10 Cycles	Per table in below
7	ESD (Operation)	C=150pF, R=330Ω · 5points/panel Air:±8KV, 5times; Contact:±4KV, 5 times;	Per table in below
8	Vibration (Non-operation)	Frequency range:10~55Hz, Stroke:1.5mm Sweep:10Hz~55Hz~10Hz 2 hours for each direction of X.Y.Z.	Per table in below
9	Shock (Non-operation)	60G 6ms, ±X,±Y,±Z 3times, for each direction	Per table in below
10	Package Drop Test	Height:80 cm, 1 corner, 3 edges, 6 surfaces	Per table in below

INSPECTION	CRITERION(after test)
Appearance	No Crack on the FPC, on the LCD Panel
Alignment of LCD Panel	No Bubbles in the LCD Panel No other Defects of Alignment in Active area
Electrical current	Within device specifications
Function / Display	No Broken Circuit, No Short Circuit or No Black line No Other Defects of Display

11. Precautions for Use of LCD Modules

11.1 Safety

The liquid crystal in the LCD is poisonous. Do not put it in your mouth. If the liquid crystal touches your skin or clothes, wash it off immediately using soap and water.

11.2 Handling

- A. The LCD and touch panel is made of plate glass. Do not subject the panel to mechanical shock or to excessive force on its surface.
- B. Do not handle the product by holding the flexible pattern portion in order to assure the reliability
- C. Transparency is an important factor for the touch panel. Please wear clear finger sacks, gloves and mask to protect the touch panel from finger print or stain and also hold the portion outside the view area when handling the touch panel.
- D. Provide a space so that the panel does not come into contact with other components.
- E. To protect the product from external force, put a covering lens (acrylic board or similar board) and keep an appropriate gap between them.
- F. Transparent electrodes may be disconnected if the panel is used under environmental conditions where dew condensation occurs.
- G. Property of semiconductor devices may be affected when they are exposed to light, possibly resulting in IC malfunctions.
- H. To prevent such IC malfunctions, your design and mounting layout shall be done in the way that the IC is not exposed to light in actual use.

11.3 Static Electricity

- A. Ground soldering iron tips, tools and testers when they are in operation.
- B. Ground your body when handling the products.
- C. Power on the LCD module before applying the voltage to the input terminals.
- D. Do not apply voltage which exceeds the absolute maximum rating.
- E. Store the products in an anti-electrostatic bag or container.
- F. Peel off the LCM protective film slowly since static electricity may be generated.

11.4 Storage

- A. Store the products in a dark place at $+25^{\circ}\text{C} \pm 10^{\circ}\text{C}$ with low humidity (40% RH to 60% RH). Don't expose to sunlight or fluorescent light.
- B. Storage in a clean environment, free from dust, active gas, and solvent.

11.5 Cleaning

- A. Do not wipe the touch panel with dry cloth, as it may cause scratch.
- B. Wipe off the stain on the product by using soft cloth moistened with ethanol. Do not allow ethanol to get in between the upper film and the bottom glass. It may cause peeling issue or defective operation. Do not use any organic solvent or detergent other than ethanol.

11.6 Cautions for installing and assembling

- A. Bezel edge must be positioned in the area between the Active area and View area. The bezel may press the touch screen and cause activation if the edge touches the active area. A gap of approximately 0.5mm is needed between the bezel and the top electrode. It may cause unexpected activation if the gap is too narrow. There is a tolerance of 0.2 to 0.3mm for the outside dimensions of the touch panel and tail. A gap must be made to absorb the tolerance in the case and connector.
- B. In order to make the display assembly stable and firm, MTU recommends to design some supporting at the display backside, especially for the display with tape-attached touch panel, such supporting is important and essential, or else, the display may drop-off from front after some period of time.
- C. Do not display the fixed pattern for a long time because it may develop image sticking due to the LCD structure. If the screen is displayed with fixed pattern, use a screen saver.

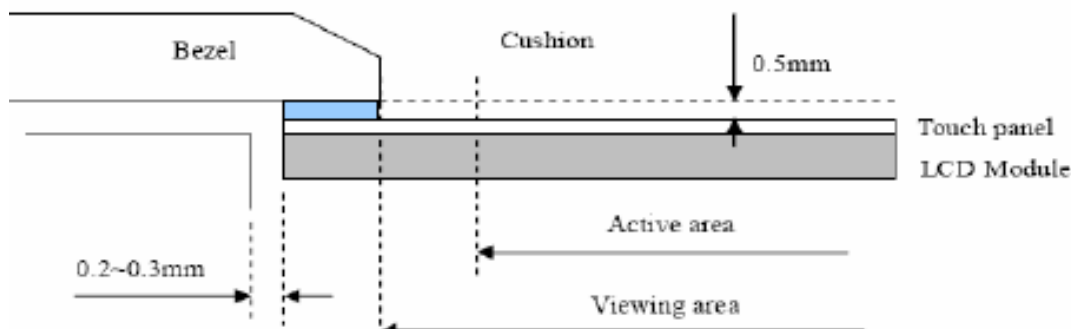

Компания «Океан Электроники» предлагает заключение долгосрочных отношений при поставках импортных электронных компонентов на взаимовыгодных условиях!

Наши преимущества:

- Поставка оригинальных импортных электронных компонентов напрямую с производств Америки, Европы и Азии, а так же с крупнейших складов мира;
- Широкая линейка поставок активных и пассивных импортных электронных компонентов (более 30 млн. наименований);
- Поставка сложных, дефицитных, либо снятых с производства позиций;
- Оперативные сроки поставки под заказ (от 5 рабочих дней);
- Экспресс доставка в любую точку России;
- Помощь Конструкторского Отдела и консультации квалифицированных инженеров;
- Техническая поддержка проекта, помощь в подборе аналогов, поставка прототипов;
- Поставка электронных компонентов под контролем ВП;
- Система менеджмента качества сертифицирована по Международному стандарту ISO 9001;
- При необходимости вся продукция военного и аэрокосмического назначения проходит испытания и сертификацию в лаборатории (по согласованию с заказчиком);
- Поставка специализированных компонентов военного и аэрокосмического уровня качества (Xilinx, Altera, Analog Devices, Intersil, Interpoint, Microsemi, Actel, Aeroflex, Peregrine, VPT, Syfer, Eurofarad, Texas Instruments, MS Kennedy, Miteq, Cobham, E2V, MA-COM, Hittite, Mini-Circuits, General Dynamics и др.);

Компания «Океан Электроники» является официальным дистрибьютором и эксклюзивным представителем в России одного из крупнейших производителей разъемов военного и аэрокосмического назначения «JONHON», а так же официальным дистрибьютором и эксклюзивным представителем в России производителя высокотехнологичных и надежных решений для передачи СВЧ сигналов «FORSTAR».



JONHON

«JONHON» (основан в 1970 г.)

Разъемы специального, военного и аэрокосмического назначения:

(Применяются в военной, авиационной, аэрокосмической, морской, железнодорожной, горно- и нефтедобывающей отраслях промышленности)

«FORSTAR» (основан в 1998 г.)

ВЧ соединители, коаксиальные кабели,
кабельные сборки и микроволновые компоненты:

(Применяются в телекоммуникациях гражданского и специального назначения, в средствах связи, РЛС, а так же военной, авиационной и аэрокосмической отраслях промышленности).



Телефон: 8 (812) 309-75-97 (многоканальный)

Факс: 8 (812) 320-03-32

Электронная почта: ocean@oceanchips.ru

Web: <http://oceanchips.ru/>

Адрес: 198099, г. Санкт-Петербург, ул. Калинина, д. 2, корп. 4, лит. А