

# 2ch High Side Switch ICs for USB Devices and Memory Cards

**BD2062FJ-LB BD2066FJ-LB**

## General Description

This product guarantees long time support in Industrial market.

High side switch for USB is a high side switch having over-current protection used in power supply line of universal serial bus (USB). Its switch unit has two channels of N-channel power MOSFET. And, over-current detection circuit, thermal shutdown circuit, under-voltage lockout and soft-start circuit are built in.

## Features

- Long time support a product for Industrial applications.
- Dual N-MOS High Side Switch
- Current Limit Threshold 2.4A
- Control input logic
  - Active-Low : BD2062FJ
  - Active-High: BD2066FJ
- Soft-Start Circuit
- Over-Current Detection
- Thermal Shutdown
- Under-Voltage Lockout
- Open-Drain Error Flag Output
- Reverse Current Protection  
When Power Switch Off
- Flag Output Delay Filter Built In
- TTL Enable Input
- 0.8ms Typical Rise Time

## Key Specifications

- Input voltage range: 2.7V to 5.5V
- ON resistance : 80mΩ(Typ.)
- Over current threshold: 1.5A min., 3.0A max.
- Standby current: 0.01μA (Typ.)
- Operating temperature range: -40°C to +85°C

## Package

SOP-J8

W(Typ.) D(Typ.) H (Max.)  
4.90mm x 6.00mm x 1.65mm

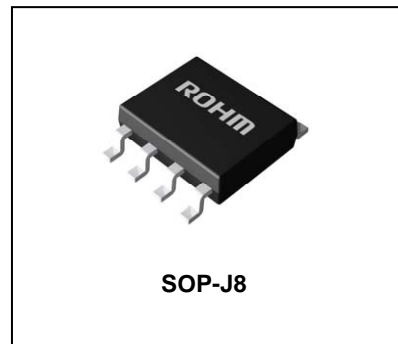

SOP-J8

## Applications

Industrial Equipment,  
PC, PC peripheral USB hub in consumer appliances,  
Car accessory, and so forth

## Typical Application Circuit

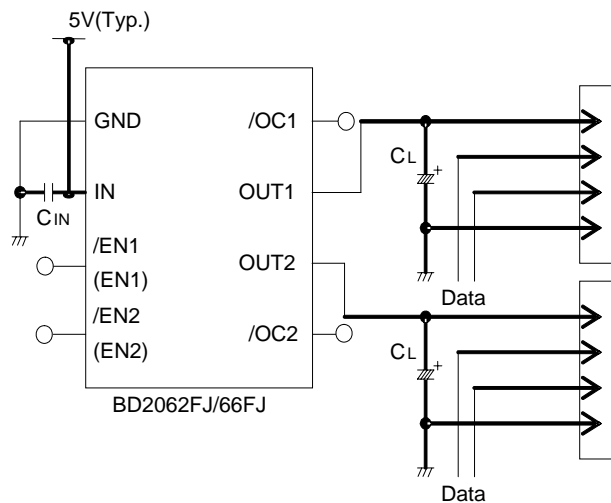

## Lineup

Over current detection			Control input logic	Package		Orderable Part Number
Min.	Typ.	Max.				
1.5A	2.4A	3.0A	Low	SOP-J8	Reel of 2500	BD2062FJ – LBE2
1.5A	2.4A	3.0A	High	SOP-J8	Reel of 2500	BD2066FJ – LBE2

Block Diagram

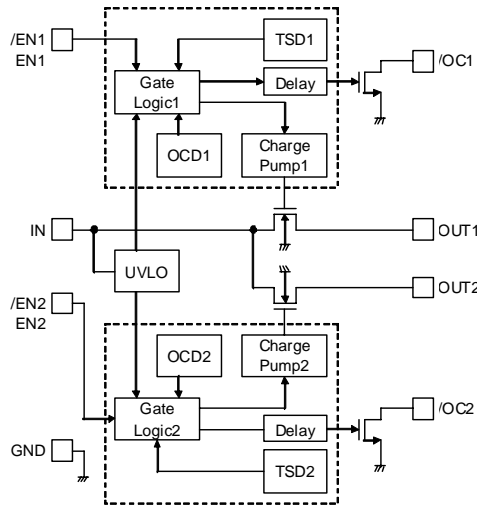

Pin Configurations

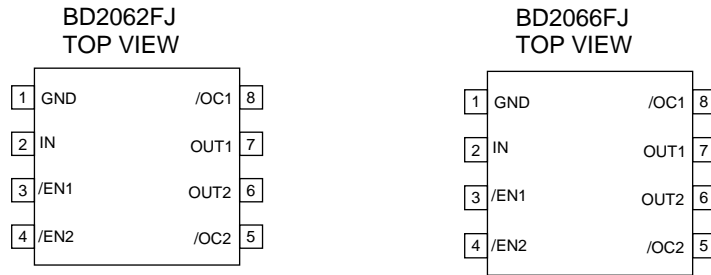

Pin Descriptions

OBD2062FJ

Pin No.	Symbol	I / O	Pin function
1	GND	-	Ground.
2	IN	-	Power supply input. Input terminal to the switch and power supply input terminal of the internal circuit.
3, 4	/EN	I	Enable input. Switch on at Low level. High level input > 2.0V, Low level input < 0.8V.
5, 8	/OC	O	Error flag output. Low at over-current, thermal shutdown. Open drain output.
6, 7	OUT	O	Switch output.

OBD2066FJ

Pin No.	Symbol	I / O	Pin function
1	GND	-	Ground.
2	IN	-	Power supply input. Input terminal to the switch and power supply input terminal of the internal circuit.
3, 4	EN	I	Enable input. Switch on at High level. High level input > 2.0V, Low level input < 0.8V
5, 8	/OC	O	Error flag output. Low at over-current, thermal shutdown. Open drain output.
6, 7	OUT	O	Switch output.

**Absolute Maximum Ratings** (Ta=25°C)

Parameter	Symbol	Ratings	Unit
Supply voltage	V <sub>IN</sub>	-0.3 to 6.0	V
Enable input voltage	V <sub>EN</sub>	-0.3 to 6.0	V
/OC voltage	V <sub>/OC</sub>	-0.3 to 6.0	V
/OC sink current	I <sub>S/OC</sub>	5	mA
OUT voltage	V <sub>OUT</sub>	-0.3 to 6.0	V
Storage temperature	T <sub>STG</sub>	-55 to 150	°C
Power dissipation	P <sub>d</sub>	675 <sup>*1</sup>	mW

\*1 Mounted on 70mm \* 70mm \* 1.6mm glass-epoxy PCB. Derating : 5.4mW/°C above Ta=25°C

**Recommended Operating Range**

Parameter	Symbol	Ratings			Unit
		Min.	Typ.	Max.	
Operating voltage	V <sub>IN</sub>	2.7	-	5.5	V
Operating temperature	T <sub>OPR</sub>	-40	-	85	°C

**Electrical Characteristics**

OBD2062FJ (Unless otherwise specified V<sub>IN</sub> = 5.0V, Ta = 25°C)

Parameter	Symbol	Limits			Unit	Conditions
		Min.	Typ.	Max.		
Operating current	I <sub>DD</sub>	-	130	180	μA	V <sub>EN</sub> = 0V , OUT=OPEN
Standby current	I <sub>STB</sub>	-	0.01	1	μA	V <sub>EN</sub> = 5V , OUT=OPEN
/EN input voltage	V <sub>/EN</sub>	2.0	-	-	V	High input
	V <sub>/EN</sub>	-	-	0.8	V	Low input
/EN input current	I <sub>/EN</sub>	-1.0	0.01	1.0	μA	V <sub>/EN</sub> = 0V or V <sub>/EN</sub> = 5V
/OC output low voltage	V <sub>/OCL</sub>	-	-	0.5	V	I <sub>/OC</sub> = 1mA
/OC output leak current	I <sub>L/OC</sub>	-	0.01	1	μA	V <sub>/OC</sub> = 5V
/OC delay time	T <sub>/OC</sub>	10	15	20	ms	
On-resistance	R <sub>ON</sub>	-	80	125	mΩ	I <sub>OUT</sub> = 500mA
Switch leak current	I <sub>LSW</sub>	-	-	1.0	μA	V <sub>EN</sub> = 5V, V <sub>OUT</sub> = 0V
Reverse leak current	I <sub>LREV</sub>	-	-	1.0	μA	V <sub>OUT</sub> = 5.5V, V <sub>IN</sub> = 0V
Current limit threshold	I <sub>TH</sub>	1.5	2.4	3.0	A	
Short circuit current	I <sub>SC</sub>	1.1	1.5	2.1	A	V <sub>OUT</sub> = 0V CL = 47μF (RMS)
Output rise time	T <sub>ON1</sub>	-	0.8	10	ms	R <sub>L</sub> = 10Ω
Output turn-on time	T <sub>ON2</sub>	-	1.1	20	ms	R <sub>L</sub> = 10Ω
Output fall time	T <sub>OFF1</sub>	-	5	20	μs	R <sub>L</sub> = 10Ω
Output turn-off time	T <sub>OFF2</sub>	-	10	40	μs	R <sub>L</sub> = 10Ω
UVLO threshold	V <sub>TUVH</sub>	2.1	2.3	2.5	V	Increasing V <sub>IN</sub>
	V <sub>TUVL</sub>	2.0	2.2	2.4	V	Decreasing V <sub>IN</sub>

**Electrical Characteristics - continued**OBD2066FJ (Unless otherwise specified  $V_{IN} = 5.0V$ ,  $T_a = 25\text{ }^{\circ}C$ )

Parameter	Symbol	Limits			Unit	Condition
		Min.	Typ.	Max.		
Operating current	$I_{DD}$	-	130	180	$\mu A$	$V_{EN} = 5V$ , $OUT=OPEN$
Standby current	$I_{STB}$	-	0.01	1	$\mu A$	$V_{EN} = 0V$ , $OUT=OPEN$
EN input voltage	$V_{EN}$	2.0	-	-	V	High input
	$V_{EN}$	-	-	0.8	V	Low input
EN input current	$I_{EN}$	-1.0	0.01	1.0	$\mu A$	$V_{EN} = 0V$ or $V_{EN} = 5V$
/OC output low voltage	$V_{/OCL}$	-	-	0.5	V	$I_{/OC} = 1mA$
/OC output leak current	$I_{L/OC}$	-	0.01	1	$\mu A$	$V_{/OC} = 5V$
/OC delay time	$T_{/OC}$	10	15	20	ms	
On-resistance	$R_{ON}$	-	80	125	m $\Omega$	$I_{OUT} = 500mA$
Switch leak current	$I_{LSW}$	-	-	1.0	$\mu A$	$V_{EN} = 0V$ , $V_{OUT} = 0V$
Reverse leak current	$I_{LREV}$	-	-	1.0	$\mu A$	$V_{OUT} = 5.5V$ , $V_{IN} = 0V$
Current limit threshold	$I_{TH}$	1.5	2.4	3.0	A	
Short circuit current	$I_{SC}$	1.1	1.5	2.1	A	$V_{OUT} = 0V$ $C_L = 47\mu F$ (RMS)
Output rise time	$T_{ON1}$	-	0.8	10	ms	$R_L = 10\Omega$
Output turn-on time	$T_{ON2}$	-	1.1	20	ms	$R_L = 10\Omega$
Output fall time	$T_{OFF1}$	-	5	20	$\mu s$	$R_L = 10\Omega$
Output turn-off time	$T_{OFF2}$	-	10	40	$\mu s$	$R_L = 10\Omega$
UVLO threshold	$V_{TUVH}$	2.1	2.3	2.5	V	Increasing $V_{IN}$
	$V_{TUVL}$	2.0	2.2	2.4	V	Decreasing $V_{IN}$

Measurement Circuit

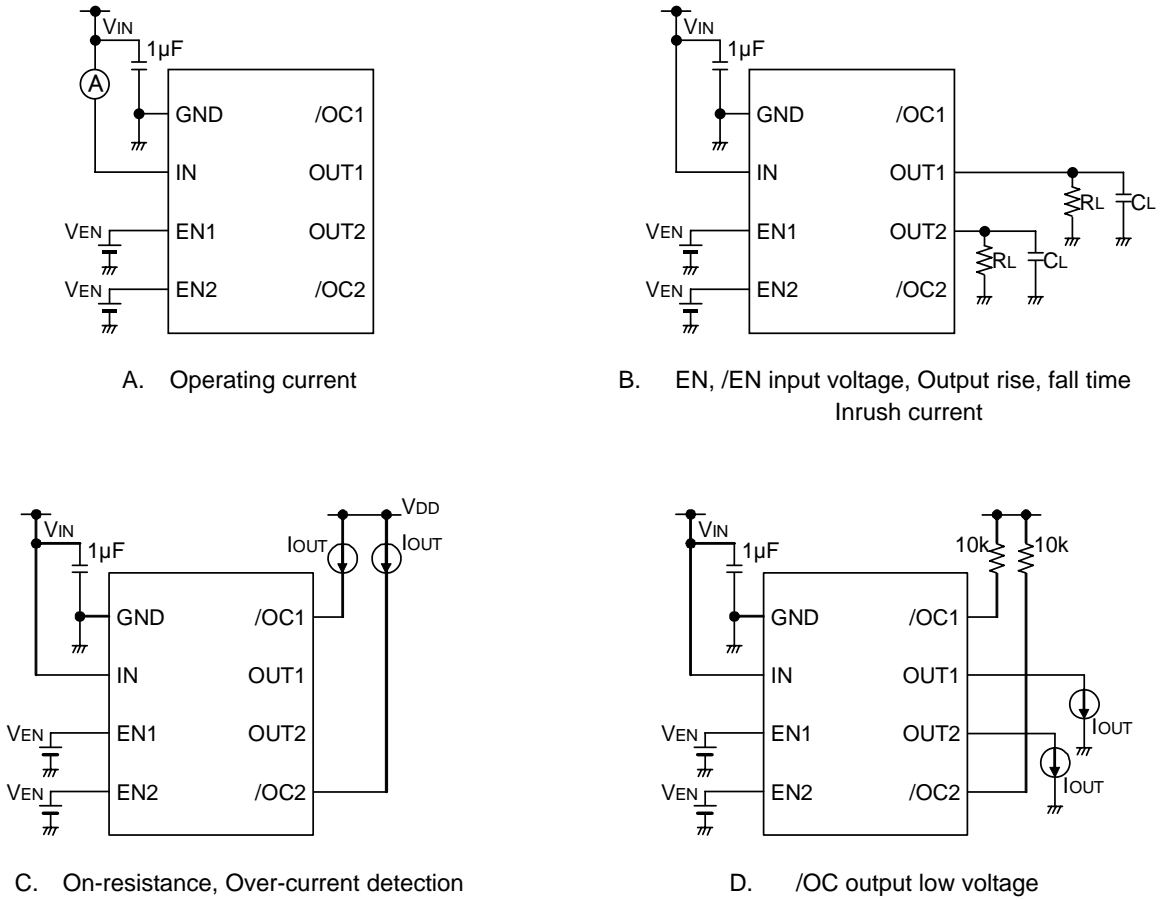

Figure 1. Measurement circuit

Timing Diagram

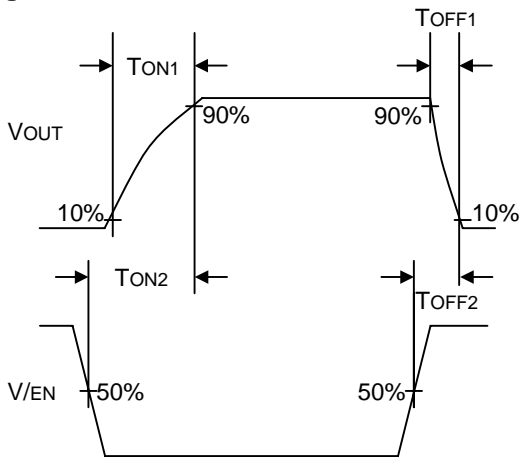

Figure 2. Timing diagram(BD2062FJ)

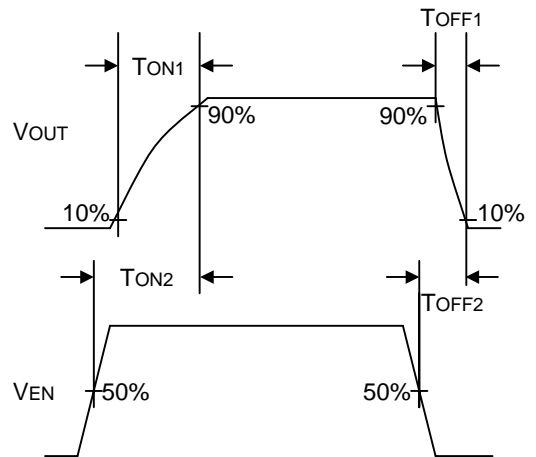

Figure 3. Timing diagram(BD2066FJ)

**Typical Performance Curves**  
(Reference Data)

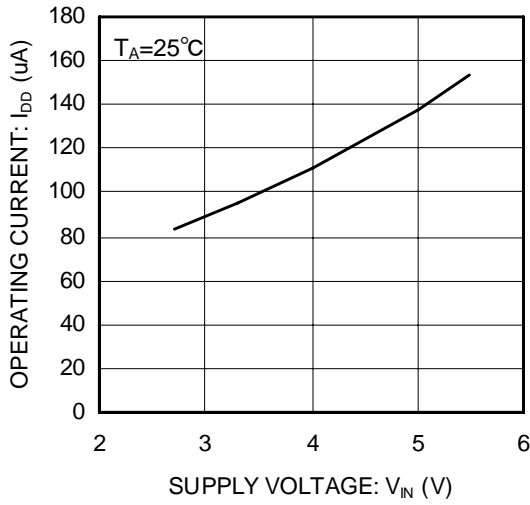

Figure 4. Operating current  
EN, /EN enable

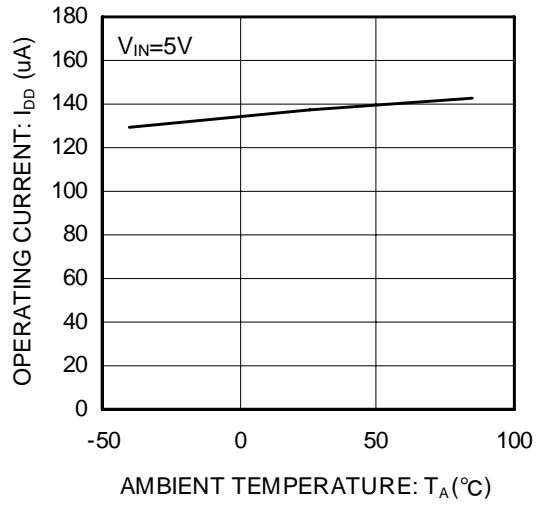

Figure 5. Operating current  
EN, /EN enable

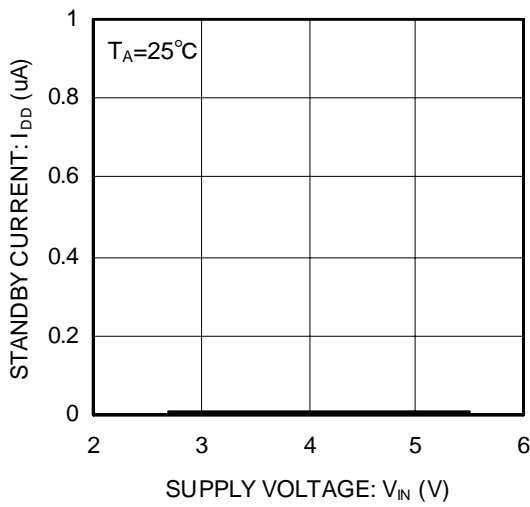

Figure 6. Standby current  
EN, /EN disable

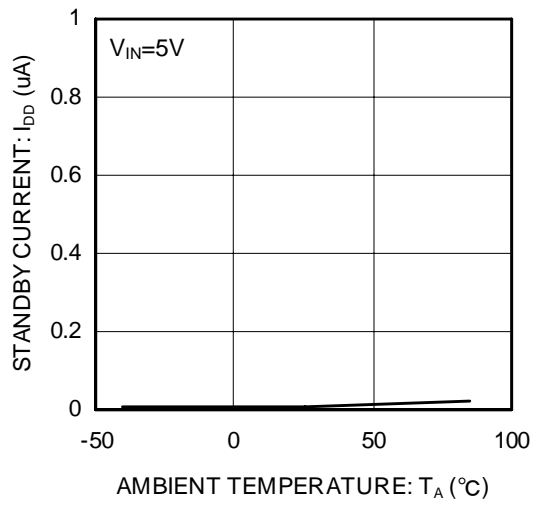

Figure 7. Standby current  
EN, /EN disable

Typical Performance Curves - continued

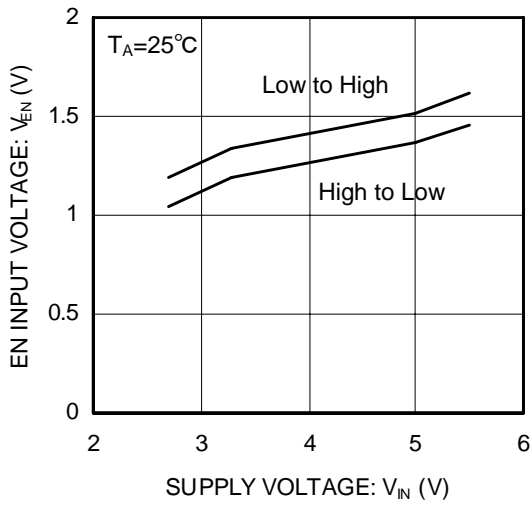

Figure 8. EN, /EN input voltage

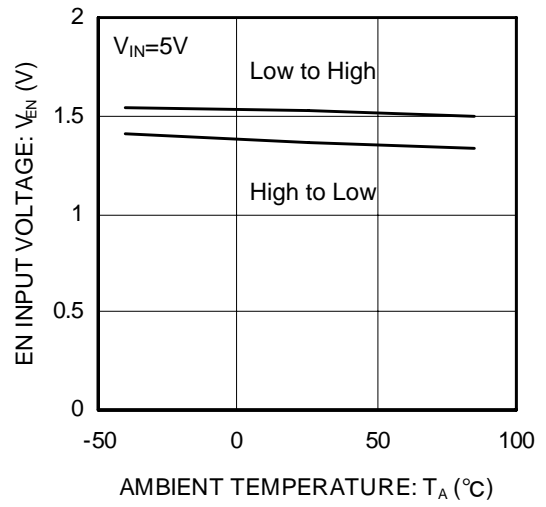

Figure 9. EN, /EN input voltage

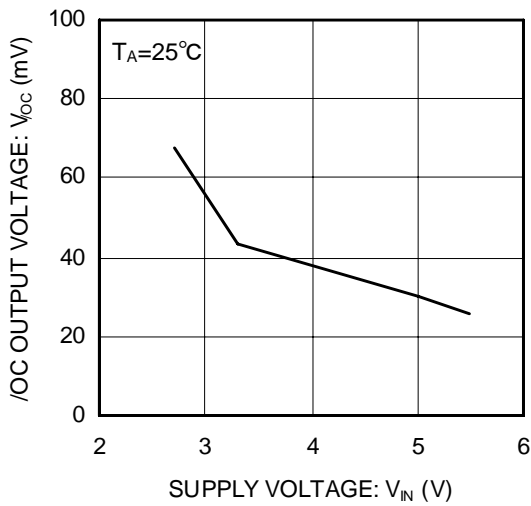

Figure 10. /OC output low voltage

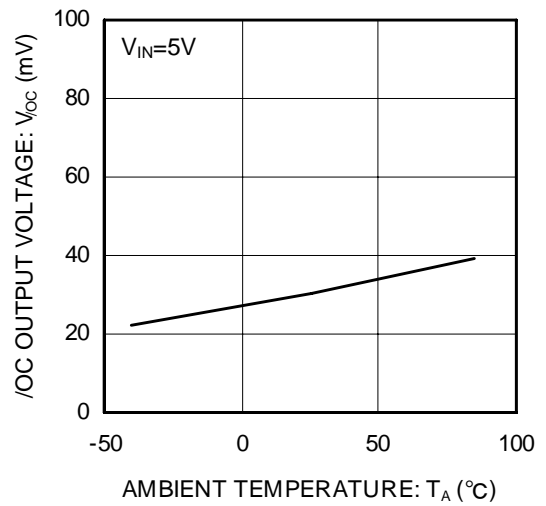

Figure 11. /OC output low voltage

Typical Performance Curves - continued

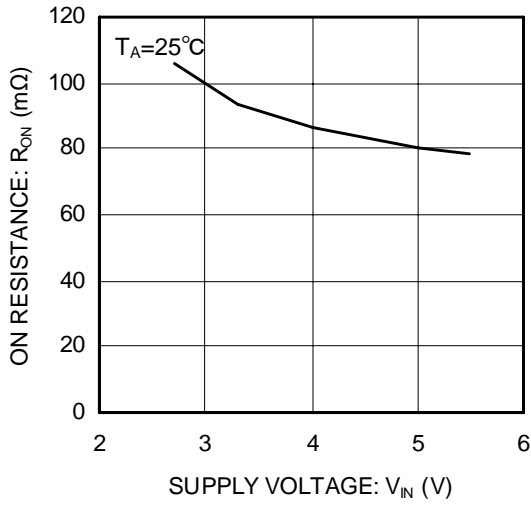

Figure 12. On-resistance

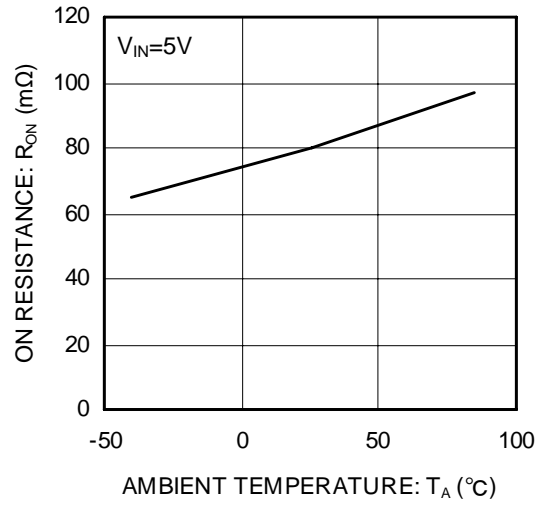

Figure 13. On-resistance

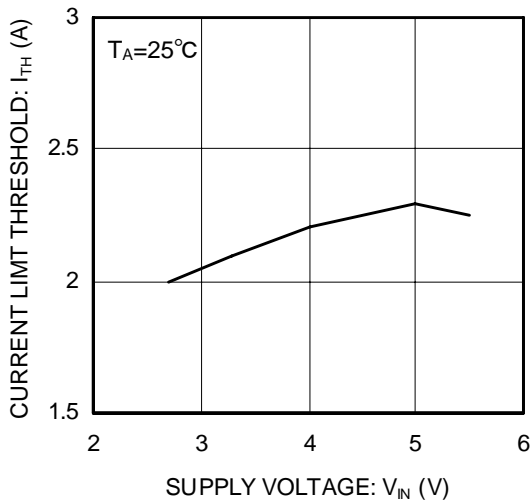

Figure 14. Current limit threshold

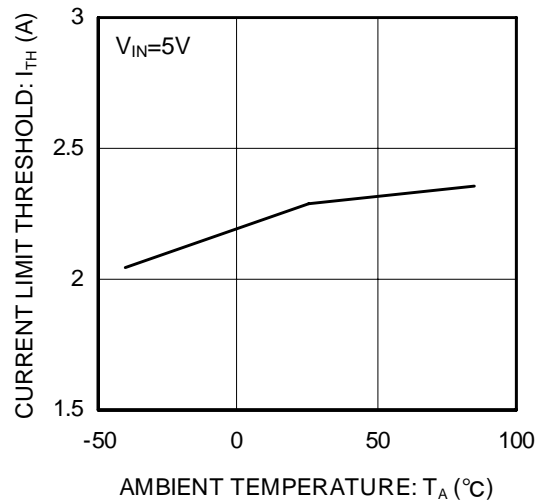

Figure 15. Current limit threshold



Typical Performance Curves - continued

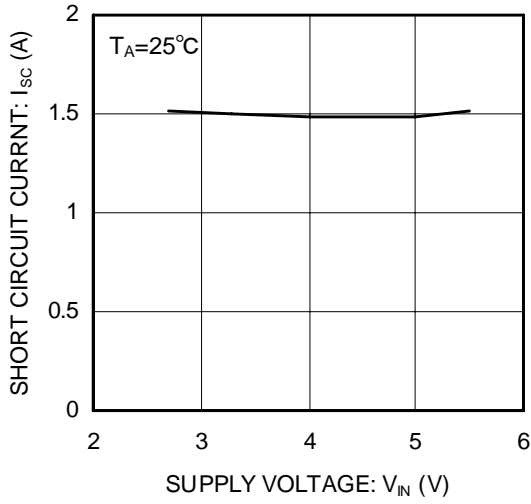

Figure 16. Short circuit current

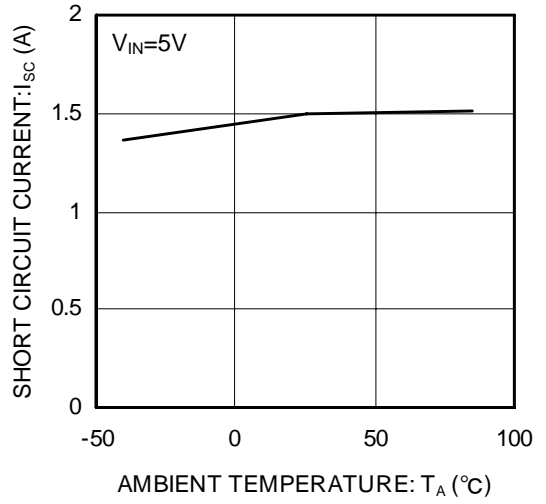

Figure 17. Short circuit current

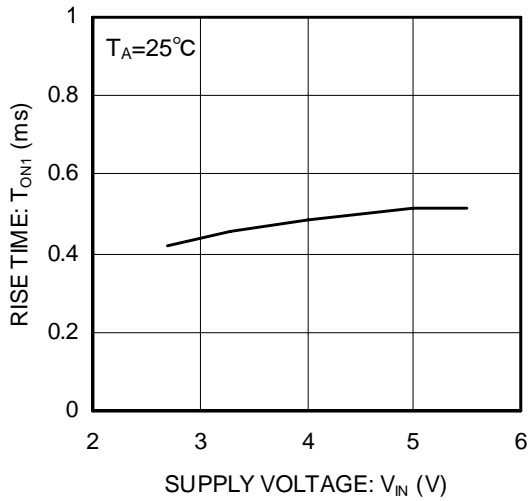

Figure 18. Output rise time

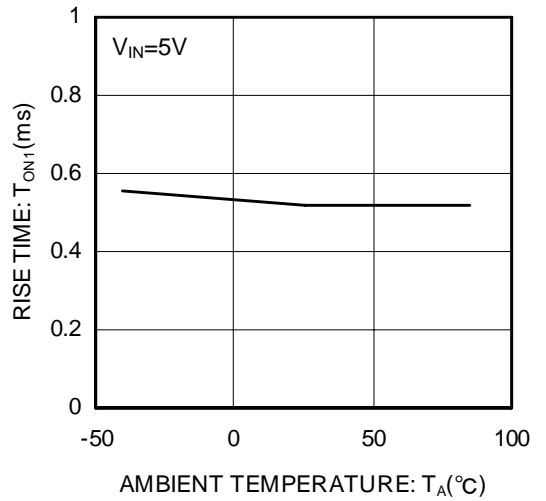

Figure 19. Output rise time

Typical Performance Curves - continued

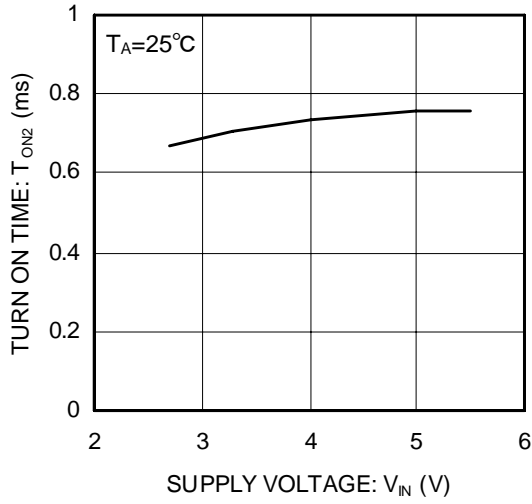

Figure 20. Output turn-on time

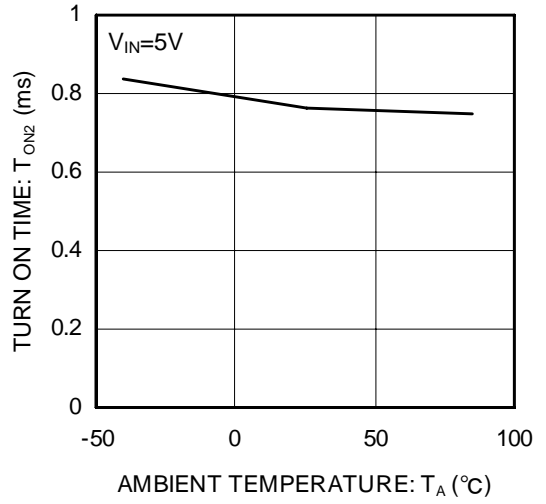

Figure 21. Output turn-on time

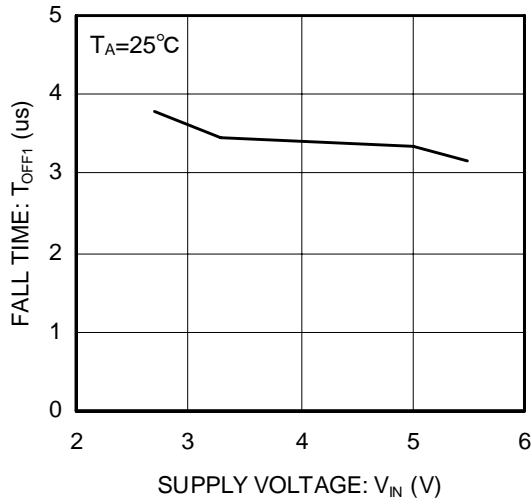

Figure 22. Output fall time

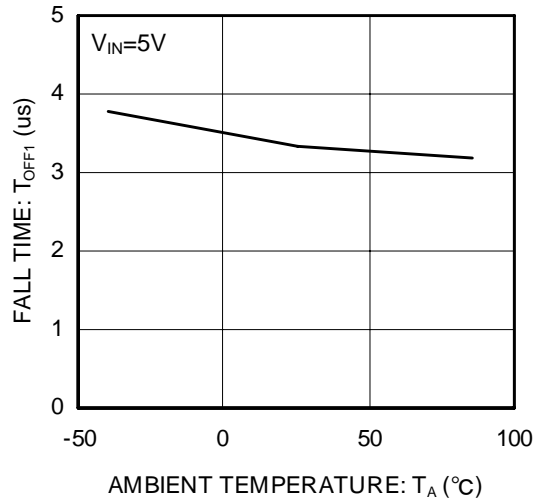

Figure 23. Output fall time

Typical Performance Curves - continued

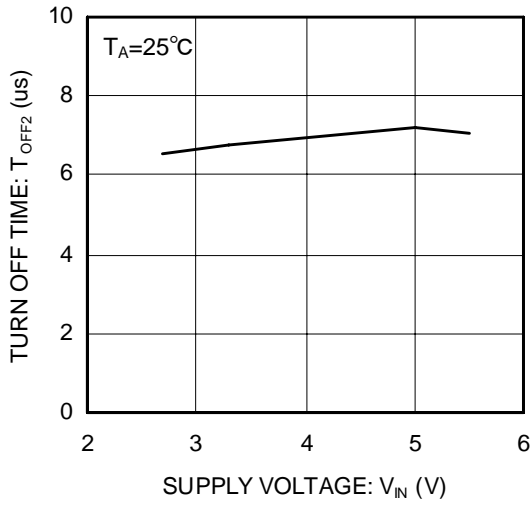

Figure 24. Output turn-off time

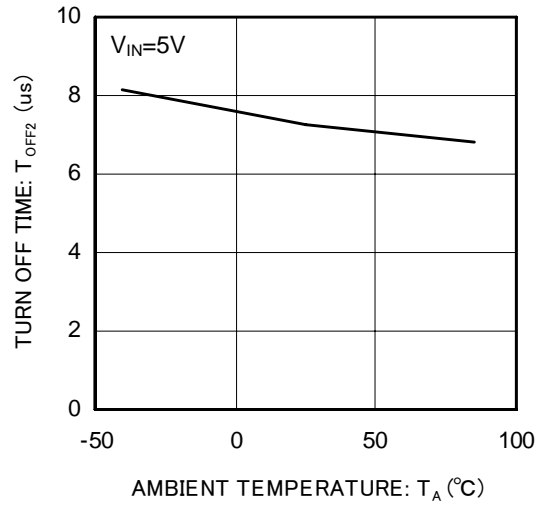

Figure 25. Output turn-off time

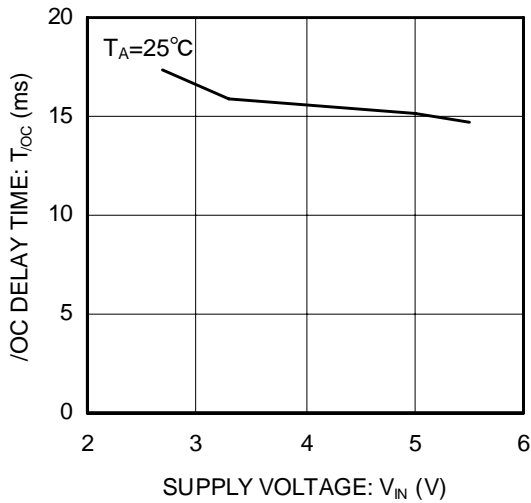

Figure 26. /OC delay time

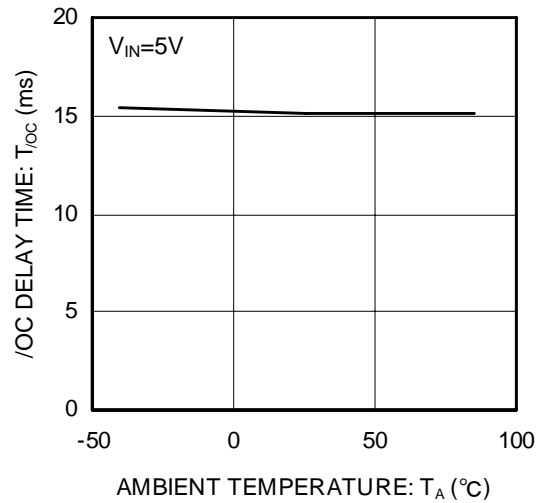

Figure 27. /OC delay time

Typical Performance Curves - continued

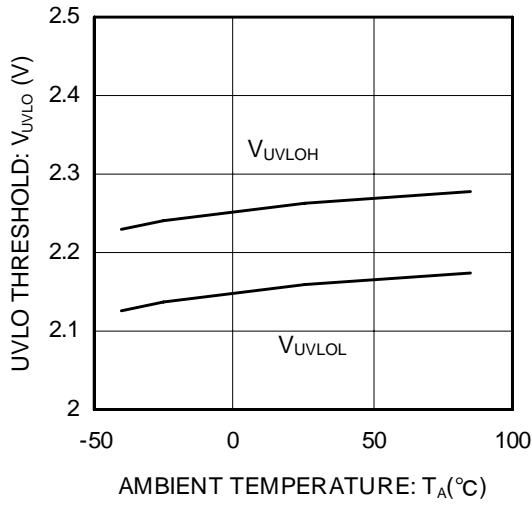

Figure 28. UVLO threshold voltage

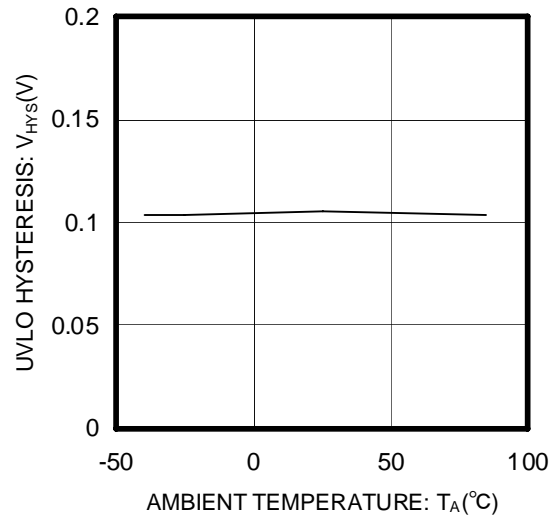

Figure 29. UVLO hysteresis voltage

Typical Wave Forms

BD2062FJ

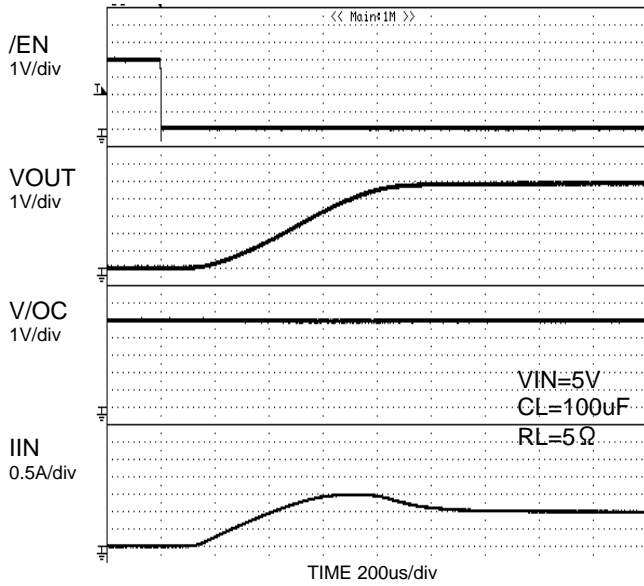

Figure 30. Output rise characteristics

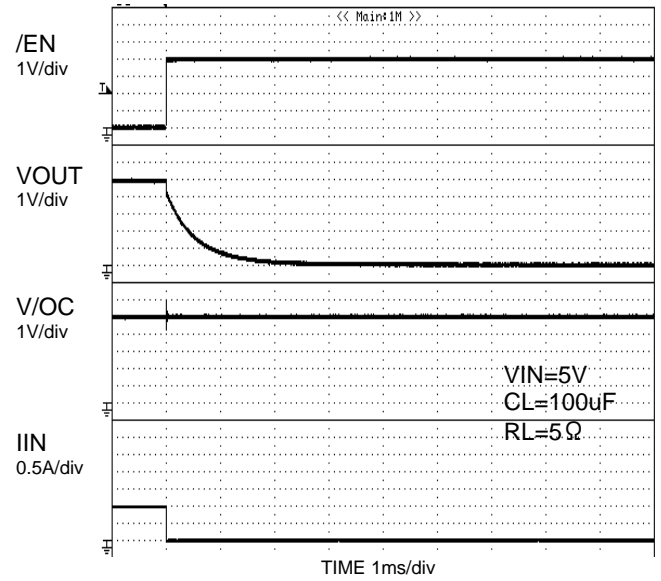

Figure 31. Output fall characteristics

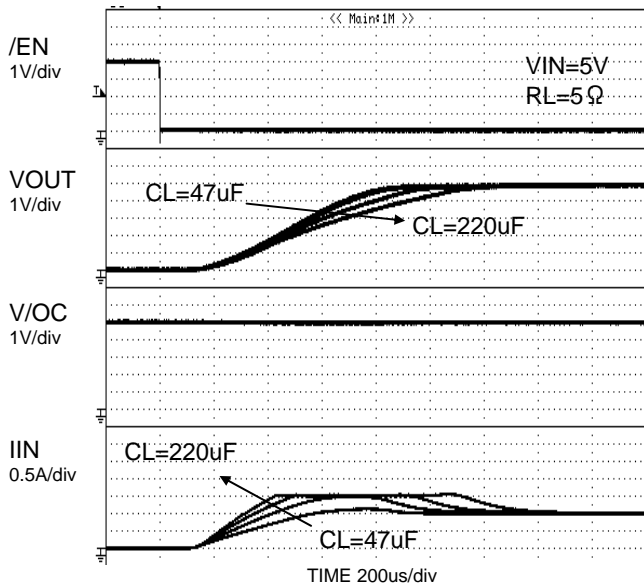

Figure 32. Inrush current  
CL=47uF, 100uF, 147uF, 220uF

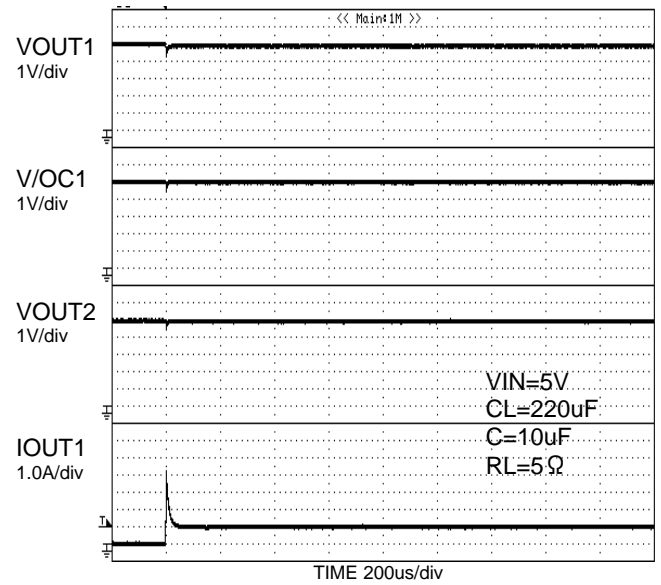

Figure 33. Inrush current

Typical Wave Forms - continued

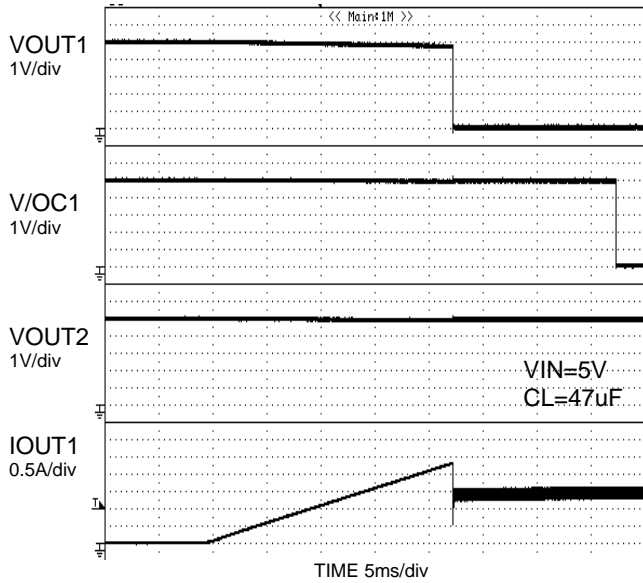

Figure 34. Over-current response ramped load

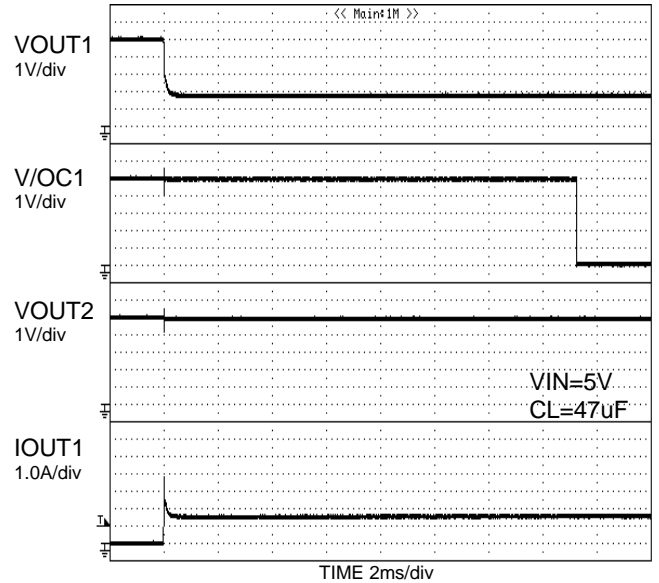

Figure 35. Over-current response 1  $\Omega$  load connected at enable

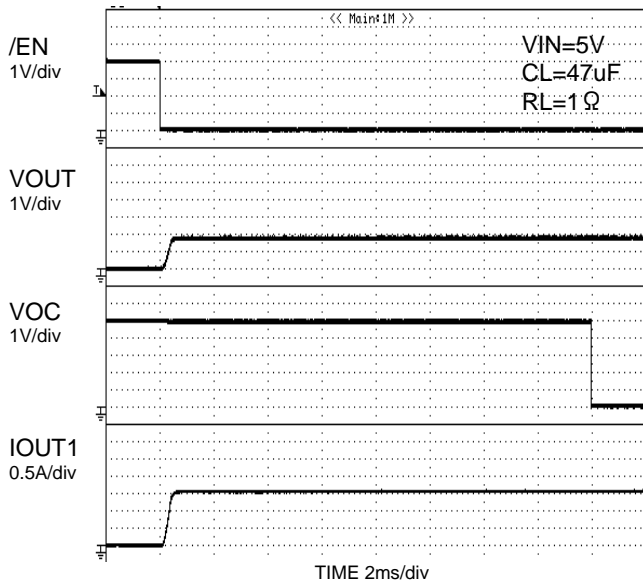

Figure 36. Over-current response enable to short circuit

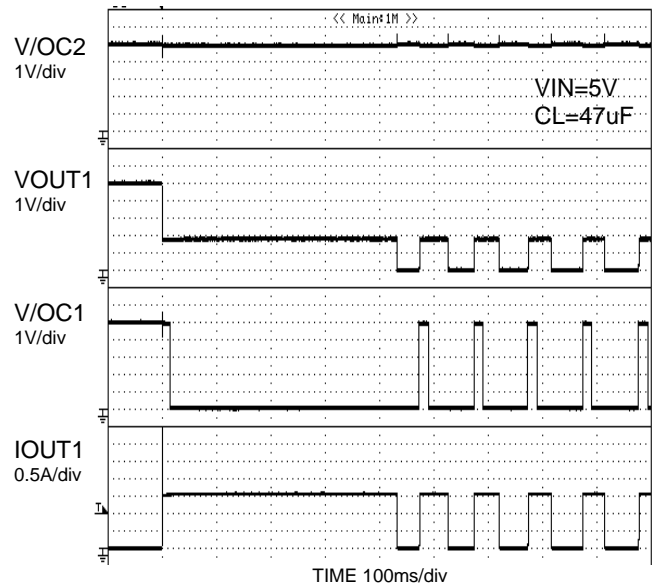
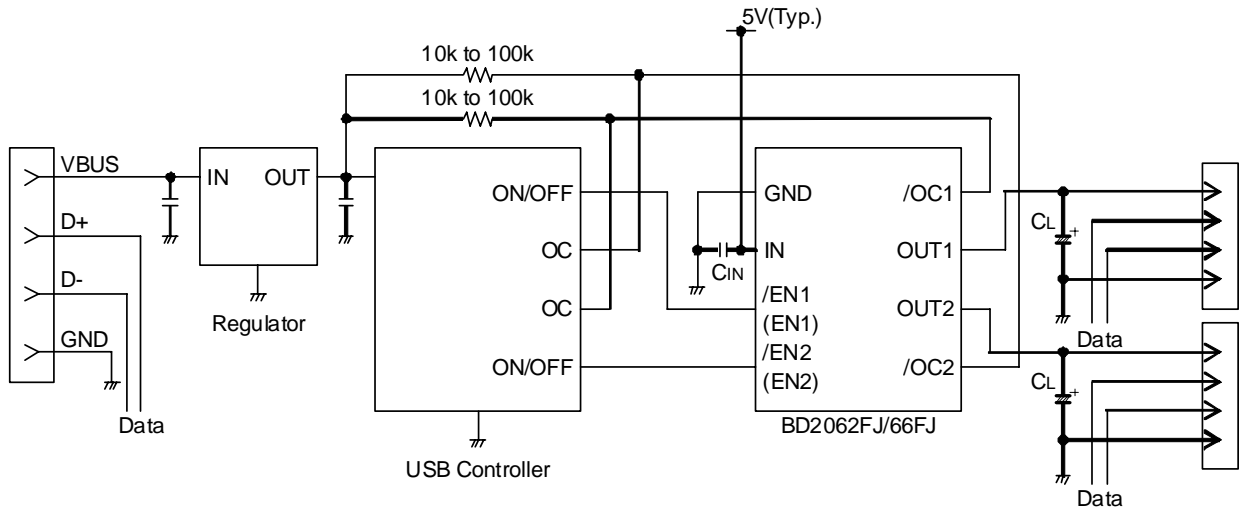

Figure 37. Thermal shutdown response

## Typical Application Circuit



## Application Information

When excessive current flows due to output short-circuit or so, ringing occurs because of inductance between power source lines to IC, and may cause bad influences on IC operations. In order to avoid this case, connect a bypass capacitor across IN terminal and GND terminal of IC. 1 $\mu$ F or higher is recommended.

Pull up /OC output by resistance 10k $\Omega$  to 100k $\Omega$ .

Set up value which satisfies the application as CL.

This application circuit does not guarantee its operation.

When using the circuit with changes to the external circuit constants, make sure to leave an adequate margin for external components including AC/DC characteristics as well as dispersion of the IC.

## Functional Description

### 1. Switch operation

IN terminal and OUT terminal are connected to the drain and the source of switch MOSFET respectively. And the IN terminal is used also as power source input to internal control circuit.

When the switch is turned on from EN/EN control input, IN terminal and OUT terminal are connected by a 80m $\Omega$  switch. In on status, the switch is bidirectional. Therefore, when the potential of OUT terminal is higher than that of IN terminal, current flows from OUT terminal to IN terminal.

Since a parasitic diode between the drain and the source of switch MOSFET is not present in the off status, it is possible to prevent current from flowing reversely from OUT to IN.

### 2. Thermal shutdown circuit (TSD)

Thermal shut down circuit have dual thermal shutdown threshold. Since thermal shutdown works at a lower junction temperature when an over-current occurs, only the switch of an over-current state become off and error flag is output. Thermal shut down action has hysteresis. Therefore, when the junction temperature goes down, switch on and error flag output automatically recover. However, until cause of junction temperature increase such as output shortcircuit is removed or the switch is turned off, thermal shut down detection and recovery are repeated. The thermal shut down circuit works when the switch of either OUT1 or OUT2 is on (EN,/EN signal is active).

3. Over-current detection (OCD)

The over-current detection circuit limits current (ISC) and outputs error flag (/OC) when current flowing in each switch MOSFET exceeds a specified value. There are three types of response against over-current. The over-current detection circuit works when the switch is on (EN,/EN signal is active).

3-1. When the switch is turned on while the output is in short-circuit state

When the switch is turned on while the output is in short-circuit status, the switch goes into current limit status immediately.

3-2. When the output short-circuits while the switch is on

When the output short-circuits or high-current load is connected while the switch is on, very large current flows until the over-current limit circuit takes into action. When the current is detected, limiter circuit works, current limitation is carried out.

3-3. When the output current increases gradually

When the output current increases gradually, current limitation does not work until the output current exceeds the over-current detection value. When it exceeds the detection value, current limitation is carried out.

4. Under-voltage lockout (UVLO)

UVLO circuit prevents the switch from turning on until the VIN exceeds 2.3V(Typ.). If the VIN drops below 2.2V(Typ.) while the switch turns on, then UVLO shuts off the switch. UVLO has hysteresis of 100mV(Typ).

Under-voltage lockout circuit works when the switch of either OUT1 or OUT2 is on (EN,/EN signal is active).

5. Error flag (/OC) output

Error flag output is N-MOS open drain output. At detection of over current or thermal shutdown, the output level is low.

Over-current detection has delay filter. This delay filter prevents instantaneous current detection such as inrush current at switch on, hot plug from being informed to outside.

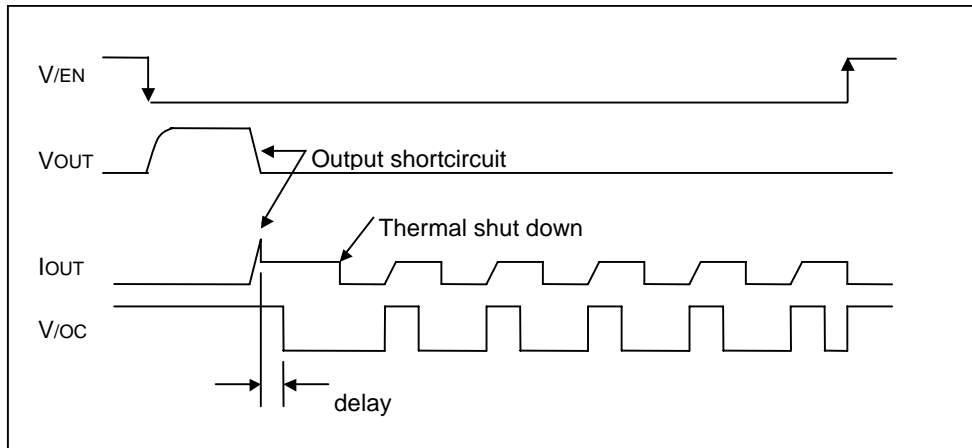

Figure 38. Over current detection, thermal shutdown timing (BD2062FJ)

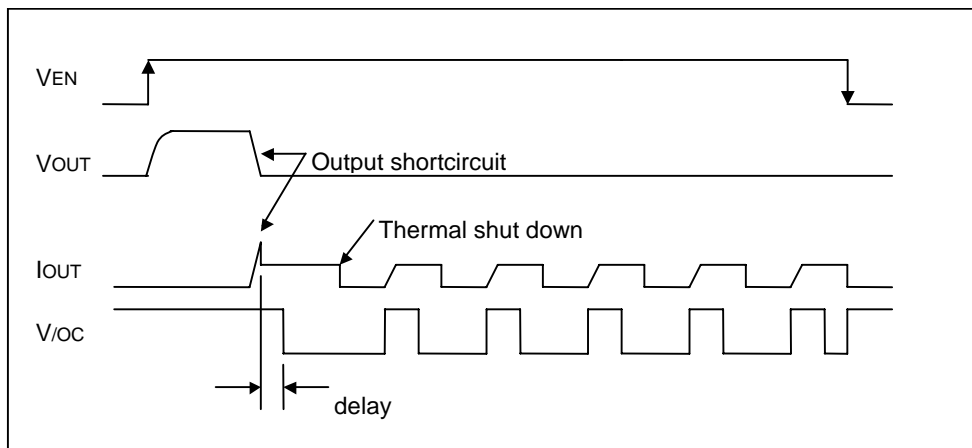

Figure 39. Over current detection, thermal shutdown timing (BD2066FJ)



**Power Dissipation**  
(SOP-J8)

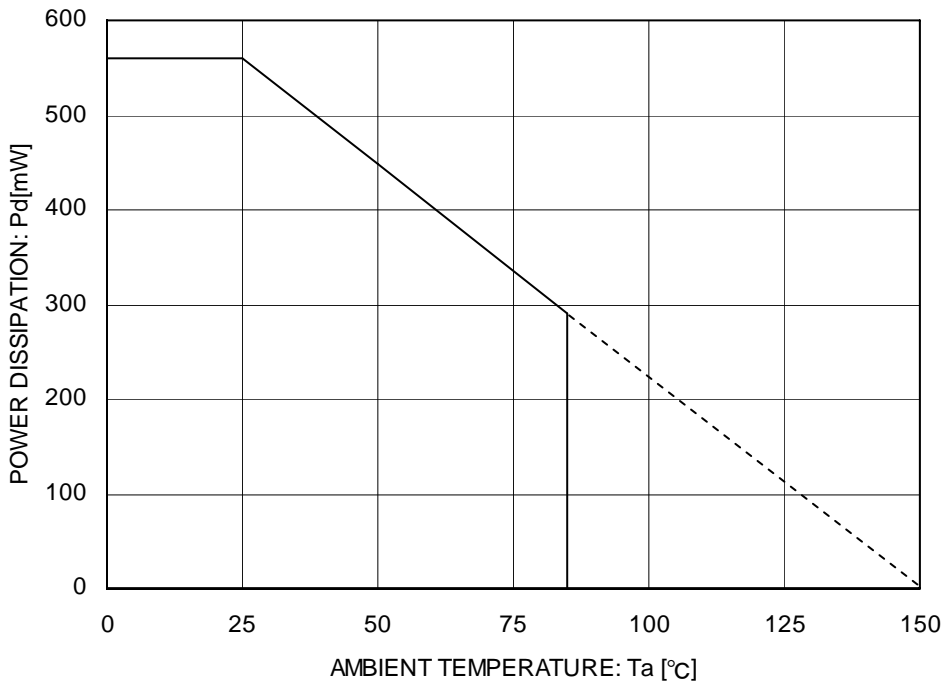

Figure 40. Power dissipation curve (Pd-Ta Curve)

**I/O Equivalence Circuit**

Symbol	Pin No	Equivalence circuit
EN1(/EN1) EN2(/EN2)	3, 4	
/OC1 /OC2	5, 8	
OUT1 OUT2	6, 7	

## Operational Notes

- (1) Absolute maximum ratings  
Operating the IC over the absolute maximum ratings may damage the IC. The damage can either be a short circuit between pins or an open circuit between pins. Therefore, it is important to consider circuit protection measures, such as adding a fuse, in case the IC is operated over the absolute maximum ratings.
- (2) Recommended operating conditions  
These conditions represent a range within which the expected characteristics of the IC can be approximately obtained. The electrical characteristics are guaranteed under the conditions of each parameter.
- (3) Reverse connection of power supply  
Connecting the power supply in reverse polarity can damage the IC. Take precautions against reverse polarity when connecting the power supply, such as mounting an external diode between the power supply and the IC's power supply terminals.
- (4) Power supply lines  
Design the PCB layout pattern to provide low impedance ground and supply lines. Separate the ground and supply lines of the digital and analog blocks to prevent noise in the ground and supply lines of the digital block from affecting the analog block. Furthermore, connect a capacitor to ground at all power supply pins. Consider the effect of temperature and aging on the capacitance value when using electrolytic capacitors.
- (5) Ground Voltage  
The voltage of the ground pin must be the lowest voltage of all pins of the IC at all operating conditions. Ensure that no pins are at a voltage below the ground pin at any time, even during transient condition.
- (6) Short between pins and mounting errors  
Be careful when mounting the IC on printed circuit boards. The IC may be damaged if it is mounted in a wrong orientation or if pins are shorted together. Short circuit may be caused by conductive particles caught between the pins.
- (7) Operation under strong electromagnetic field  
Operating the IC in the presence of a strong electromagnetic field may cause the IC to malfunction.
- (8) Testing on application boards  
When testing the IC on an application board, connecting a capacitor directly to a low-impedance output pin may subject the IC to stress. Always discharge capacitors completely after each process or step. The IC's power supply should always be turned off completely before connecting or removing it from the test setup during the inspection process. To prevent damage from static discharge, ground the IC during assembly and use similar precautions during transport and storage.
- (9) Regarding input pins of the IC  
This monolithic IC contains P+ isolation and P substrate layers between adjacent elements in order to keep them isolated. P-N junctions are formed at the intersection of the P layers with the N layers of other elements, creating a parasitic diode or transistor. For example (refer to figure below):

When  $GND > Pin A$  and  $GND > Pin B$ , the P-N junction operates as a parasitic diode

When  $GND > Pin B$ , the P-N junction operates as a parasitic transistor.

Parasitic diodes inevitably occur in the structure of the IC. The operation of parasitic diodes can result in mutual interference among circuits, operational faults, or physical damage. Therefore, conditions that cause these diodes to operate, such as applying a voltage lower than the GND voltage to an input pin (and thus to the P substrate) should be avoided.

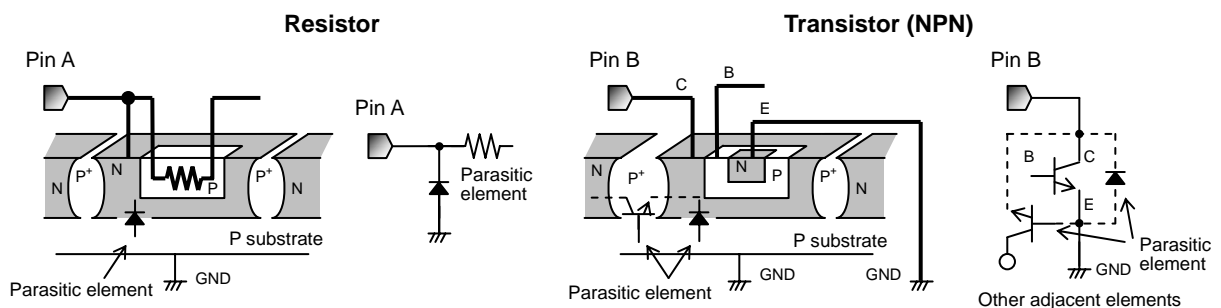

Figure 41. Example of monolithic IC structure

## (10) GND wiring pattern

When using both small-signal and large-current GND traces, the two ground traces should be routed separately but connected to a single ground at the reference point of the application board to avoid fluctuations in the small-signal ground caused by large currents. Also ensure that the GND traces of external components do not cause variations on the GND voltage. The power supply and ground lines must be as short and thick as possible to reduce line impedance.

## (11) External Capacitor

When using a ceramic capacitor, determine the dielectric constant considering the change of capacitance with temperature and the decrease in nominal capacitance due to DC bias and others.

## (12) Thermal shutdown circuit (TSD)

The IC incorporates a built-in thermal shutdown circuit, which is designed to turn off the IC when the internal temperature of the IC reaches a specified value. Do not continue to operate the IC after this function is activated. Do not use the IC in conditions where this function will always be activated.

## (13) Thermal consideration

Use a thermal design that allows for a sufficient margin by taking into account the permissible power dissipation (Pd) in actual operating conditions. Consider Pc that does not exceed Pd in actual operating conditions ( $P_c \geq P_d$ ).

$$\text{Package Power dissipation} \quad : P_d \text{ (W)} = (T_{j\max} - T_a) / \theta_{ja}$$

$$\text{Power dissipation} \quad : P_c \text{ (W)} = (V_{cc} - V_o) \times I_o + V_{cc} \times I_b$$

( T<sub>jmax</sub> : Maximum junction temperature=150°C, T<sub>a</sub> : Peripheral temperature[°C],  
 $\theta_{ja}$  : Thermal resistance of package-ambience[°C/W], P<sub>d</sub> : Package Power dissipation [W],  
 P<sub>c</sub> : Power dissipation [W], V<sub>cc</sub> : Input Voltage, V<sub>o</sub> : Output Voltage, I<sub>o</sub> : Load, I<sub>b</sub> : Bias Current )

**Ordering Information**

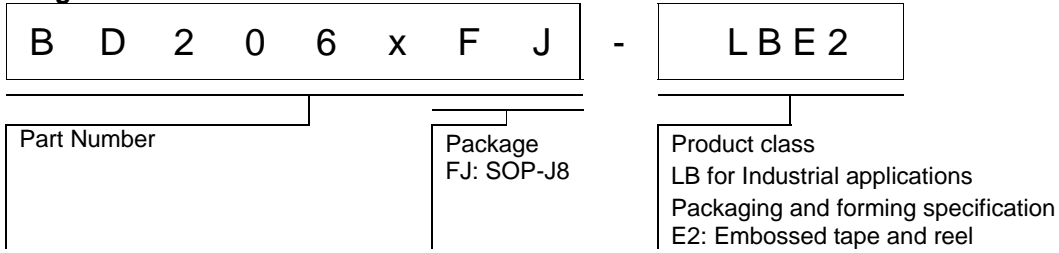

**Marking Diagram**

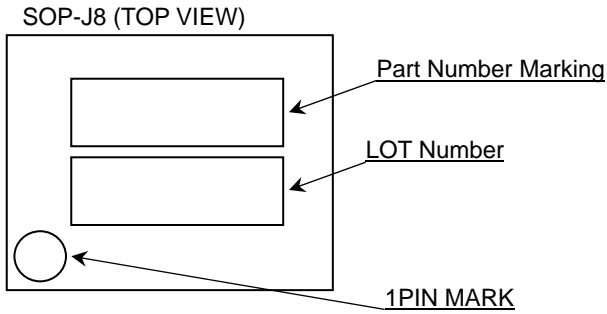

Part Number	Part Number Marking
BD2062FJ	D2062
BD2066FJ	D2066

Physical Dimension Tape and Reel Information

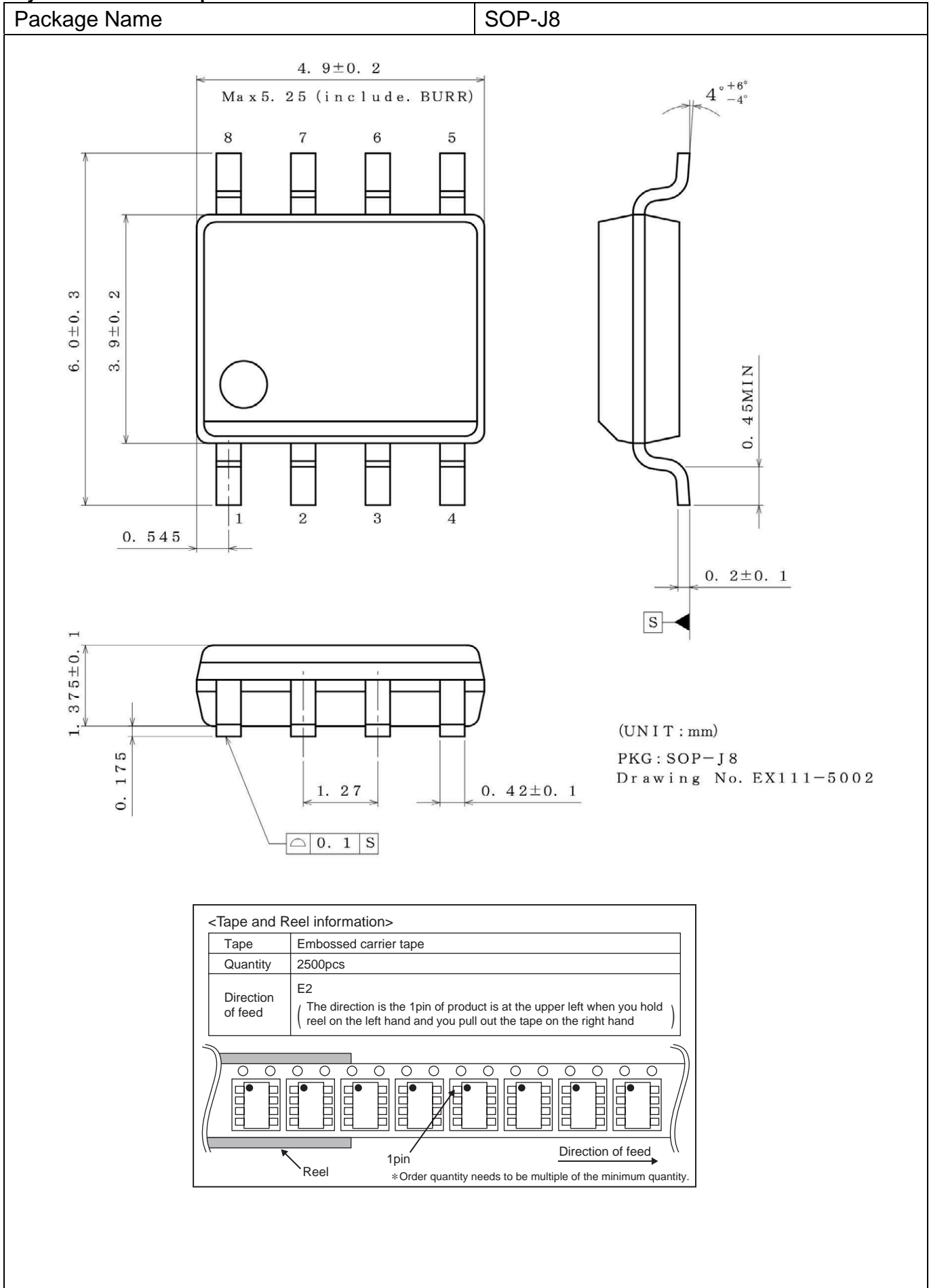

**Revision History**

Date	Revision	Changes
13.Mar.2013	001	New Release
21.Feb.2014	002	Delete sentence "and log life cycle" in General Description and Futures (page 1). Change "Industrial Applications" to "Industrial Equipment" in Applications (page 1). Applied new style ("title", "Ordering Information" and "Physical Dimension Tape and Reel Information").

# Notice

## Precaution on using ROHM Products

1. If you intend to use our Products in devices requiring extremely high reliability (such as medical equipment <sup>(Note 1)</sup>, aircraft/spacecraft, nuclear power controllers, etc.) and whose malfunction or failure may cause loss of human life, bodily injury or serious damage to property ("Specific Applications"), please consult with the ROHM sales representative in advance. Unless otherwise agreed in writing by ROHM in advance, ROHM shall not be in any way responsible or liable for any damages, expenses or losses incurred by you or third parties arising from the use of any ROHM's Products for Specific Applications.

(Note1) Medical Equipment Classification of the Specific Applications

JAPAN	USA	EU	CHINA
CLASS III	CLASS III	CLASS II b	CLASS III
CLASS IV		CLASS III	

2. ROHM designs and manufactures its Products subject to strict quality control system. However, semiconductor products can fail or malfunction at a certain rate. Please be sure to implement, at your own responsibilities, adequate safety measures including but not limited to fail-safe design against the physical injury, damage to any property, which a failure or malfunction of our Products may cause. The following are examples of safety measures:
  - [a] Installation of protection circuits or other protective devices to improve system safety
  - [b] Installation of redundant circuits to reduce the impact of single or multiple circuit failure
3. Our Products are not designed under any special or extraordinary environments or conditions, as exemplified below. Accordingly, ROHM shall not be in any way responsible or liable for any damages, expenses or losses arising from the use of any ROHM's Products under any special or extraordinary environments or conditions. If you intend to use our Products under any special or extraordinary environments or conditions (as exemplified below), your independent verification and confirmation of product performance, reliability, etc, prior to use, must be necessary:
  - [a] Use of our Products in any types of liquid, including water, oils, chemicals, and organic solvents
  - [b] Use of our Products outdoors or in places where the Products are exposed to direct sunlight or dust
  - [c] Use of our Products in places where the Products are exposed to sea wind or corrosive gases, including Cl<sub>2</sub>, H<sub>2</sub>S, NH<sub>3</sub>, SO<sub>2</sub>, and NO<sub>2</sub>
  - [d] Use of our Products in places where the Products are exposed to static electricity or electromagnetic waves
  - [e] Use of our Products in proximity to heat-producing components, plastic cords, or other flammable items
  - [f] Sealing or coating our Products with resin or other coating materials
  - [g] Use of our Products without cleaning residue of flux (even if you use no-clean type fluxes, cleaning residue of flux is recommended); or Washing our Products by using water or water-soluble cleaning agents for cleaning residue after soldering
  - [h] Use of the Products in places subject to dew condensation
4. The Products are not subject to radiation-proof design.
5. Please verify and confirm characteristics of the final or mounted products in using the Products.
6. In particular, if a transient load (a large amount of load applied in a short period of time, such as pulse. is applied, confirmation of performance characteristics after on-board mounting is strongly recommended. Avoid applying power exceeding normal rated power; exceeding the power rating under steady-state loading condition may negatively affect product performance and reliability.
7. De-rate Power Dissipation (Pd) depending on Ambient temperature (Ta). When used in sealed area, confirm the actual ambient temperature.
8. Confirm that operation temperature is within the specified range described in the product specification.
9. ROHM shall not be in any way responsible or liable for failure induced under deviant condition from what is defined in this document.

## Precaution for Mounting / Circuit board design

1. When a highly active halogenous (chlorine, bromine, etc.) flux is used, the residue of flux may negatively affect product performance and reliability.
2. In principle, the reflow soldering method must be used; if flow soldering method is preferred, please consult with the ROHM representative in advance.

For details, please refer to ROHM Mounting specification

**Precautions Regarding Application Examples and External Circuits**

1. If change is made to the constant of an external circuit, please allow a sufficient margin considering variations of the characteristics of the Products and external components, including transient characteristics, as well as static characteristics.
2. You agree that application notes, reference designs, and associated data and information contained in this document are presented only as guidance for Products use. Therefore, in case you use such information, you are solely responsible for it and you must exercise your own independent verification and judgment in the use of such information contained in this document. ROHM shall not be in any way responsible or liable for any damages, expenses or losses incurred by you or third parties arising from the use of such information.

**Precaution for Electrostatic**

This Product is electrostatic sensitive product, which may be damaged due to electrostatic discharge. Please take proper caution in your manufacturing process and storage so that voltage exceeding the Products maximum rating will not be applied to Products. Please take special care under dry condition (e.g. Grounding of human body / equipment / solder iron, isolation from charged objects, setting of Ionizer, friction prevention and temperature / humidity control).

**Precaution for Storage / Transportation**

1. Product performance and soldered connections may deteriorate if the Products are stored in the places where:
  - [a] the Products are exposed to sea winds or corrosive gases, including Cl<sub>2</sub>, H<sub>2</sub>S, NH<sub>3</sub>, SO<sub>2</sub>, and NO<sub>2</sub>
  - [b] the temperature or humidity exceeds those recommended by ROHM
  - [c] the Products are exposed to direct sunshine or condensation
  - [d] the Products are exposed to high Electrostatic
2. Even under ROHM recommended storage condition, solderability of products out of recommended storage time period may be degraded. It is strongly recommended to confirm solderability before using Products of which storage time is exceeding the recommended storage time period.
3. Store / transport cartons in the correct direction, which is indicated on a carton with a symbol. Otherwise bent leads may occur due to excessive stress applied when dropping of a carton.
4. Use Products within the specified time after opening a humidity barrier bag. Baking is required before using Products of which storage time is exceeding the recommended storage time period.

**Precaution for Product Label**

QR code printed on ROHM Products label is for ROHM's internal use only.

**Precaution for Disposition**

When disposing Products please dispose them properly using an authorized industry waste company.

**Precaution for Foreign Exchange and Foreign Trade act**

Since our Products might fall under controlled goods prescribed by the applicable foreign exchange and foreign trade act, please consult with ROHM representative in case of export.

**Precaution Regarding Intellectual Property Rights**

1. All information and data including but not limited to application example contained in this document is for reference only. ROHM does not warrant that foregoing information or data will not infringe any intellectual property rights or any other rights of any third party regarding such information or data. ROHM shall not be in any way responsible or liable for infringement of any intellectual property rights or other damages arising from use of such information or data.:
2. No license, expressly or implied, is granted hereby under any intellectual property rights or other rights of ROHM or any third parties with respect to the information contained in this document.

**Other Precaution**

1. This document may not be reprinted or reproduced, in whole or in part, without prior written consent of ROHM.
2. The Products may not be disassembled, converted, modified, reproduced or otherwise changed without prior written consent of ROHM.
3. In no event shall you use in any way whatsoever the Products and the related technical information contained in the Products or this document for any military purposes, including but not limited to, the development of mass-destruction weapons.
4. The proper names of companies or products described in this document are trademarks or registered trademarks of ROHM, its affiliated companies or third parties.



**General Precaution**

1. Before you use our Products, you are requested to carefully read this document and fully understand its contents. ROHM shall not be in any way responsible or liable for failure, malfunction or accident arising from the use of any ROHM's Products against warning, caution or note contained in this document.
2. All information contained in this document is current as of the issuing date and subject to change without any prior notice. Before purchasing or using ROHM's Products, please confirm the latest information with a ROHM sales representative.
3. The information contained in this document is provided on an "as is" basis and ROHM does not warrant that all information contained in this document is accurate and/or error-free. ROHM shall not be in any way responsible or liable for any damages, expenses or losses incurred by you or third parties resulting from inaccuracy or errors of or concerning such information.

Компания «Океан Электроники» предлагает заключение долгосрочных отношений при поставках импортных электронных компонентов на взаимовыгодных условиях!

Наши преимущества:

- Поставка оригинальных импортных электронных компонентов напрямую с производств Америки, Европы и Азии, а так же с крупнейших складов мира;
- Широкая линейка поставок активных и пассивных импортных электронных компонентов (более 30 млн. наименований);
- Поставка сложных, дефицитных, либо снятых с производства позиций;
- Оперативные сроки поставки под заказ (от 5 рабочих дней);
- Экспресс доставка в любую точку России;
- Помощь Конструкторского Отдела и консультации квалифицированных инженеров;
- Техническая поддержка проекта, помощь в подборе аналогов, поставка прототипов;
- Поставка электронных компонентов под контролем ВП;
- Система менеджмента качества сертифицирована по Международному стандарту ISO 9001;
- При необходимости вся продукция военного и аэрокосмического назначения проходит испытания и сертификацию в лаборатории (по согласованию с заказчиком);
- Поставка специализированных компонентов военного и аэрокосмического уровня качества (Xilinx, Altera, Analog Devices, Intersil, Interpoint, Microsemi, Actel, Aeroflex, Peregrine, VPT, Syfer, Eurofarad, Texas Instruments, MS Kennedy, Miteq, Cobham, E2V, MA-COM, Hittite, Mini-Circuits, General Dynamics и др.);

Компания «Океан Электроники» является официальным дистрибьютором и эксклюзивным представителем в России одного из крупнейших производителей разъемов военного и аэрокосмического назначения «JONHON», а так же официальным дистрибьютором и эксклюзивным представителем в России производителя высокотехнологичных и надежных решений для передачи СВЧ сигналов «FORSTAR».



## JONHON

«JONHON» (основан в 1970 г.)

Разъемы специального, военного и аэрокосмического назначения:

(Применяются в военной, авиационной, аэрокосмической, морской, железнодорожной, горно- и нефтедобывающей отраслях промышленности)

«FORSTAR» (основан в 1998 г.)

ВЧ соединители, коаксиальные кабели, кабельные сборки и микроволновые компоненты:

(Применяются в телекоммуникациях гражданского и специального назначения, в средствах связи, РЛС, а так же военной, авиационной и аэрокосмической отраслях промышленности).



Телефон: 8 (812) 309-75-97 (многоканальный)

Факс: 8 (812) 320-03-32

Электронная почта: [ocean@oceanchips.ru](mailto:ocean@oceanchips.ru)

Web: <http://oceanchips.ru/>

Адрес: 198099, г. Санкт-Петербург, ул. Калинина, д. 2, корп. 4, лит. А