

Table of Contents

MULTIGIG RT Connector	137-162
Product Line Overview	138
Connector Sequencing Chart	139
Mating Sequencing Chart	140
Product Selection Guide	141-143
Customization Options	144-146
MULTIGIG RT Tier 1 Connector System	147, 148
MULTIGIG RT Tier 2 Connector System	149, 150
Connector Selection Grid for VITA 41 VXS Compliant Connectors	151-153
Connector Selection Grid for VITA 46 VPX Compliant Connectors	154-157
“New” MULTIGIG RT Stacking Connector	158
Power Modules and Guide Hardware Reference	159-162

VITA, VMEbus, VPX, and VXS are trademarks of VITA.

MULTIGIG RT Connector Products

Product Facts

- Customizable impedance matched printed circuit wafer interface
- Available for stacking applications
- Inverse sex backplane connector system with “pinless” interface
- Superior crosstalk performance
- Optimized footprints for signal integrity and ease of board design
- Utilizes a 0.56 [.022] diameter via for backplane connector for lower cost board fabrication
- Three levels of signal contact sequencing
- Available in modular style
- Available for 20.30 [.800] or 25.40 [1.00] card pitch systems
- Durability rated for 200 cycles
- Fully compatible with MP based fiber optic array interconnects
- Complete connector family includes
 - Power Modules = > Maximize Amps/inch density, voltages in pairs
 - Guidance Modules
 - Die cast for strength
 - Optional ESD contact
 - Three sequence levels
 - Press fit or hardware mounted
 - Backplane drill pattern enabled keying
 - Cable assembly proposals available
- MULTIGIG RT connector products are fully compatible with 2mm HM equipment practices

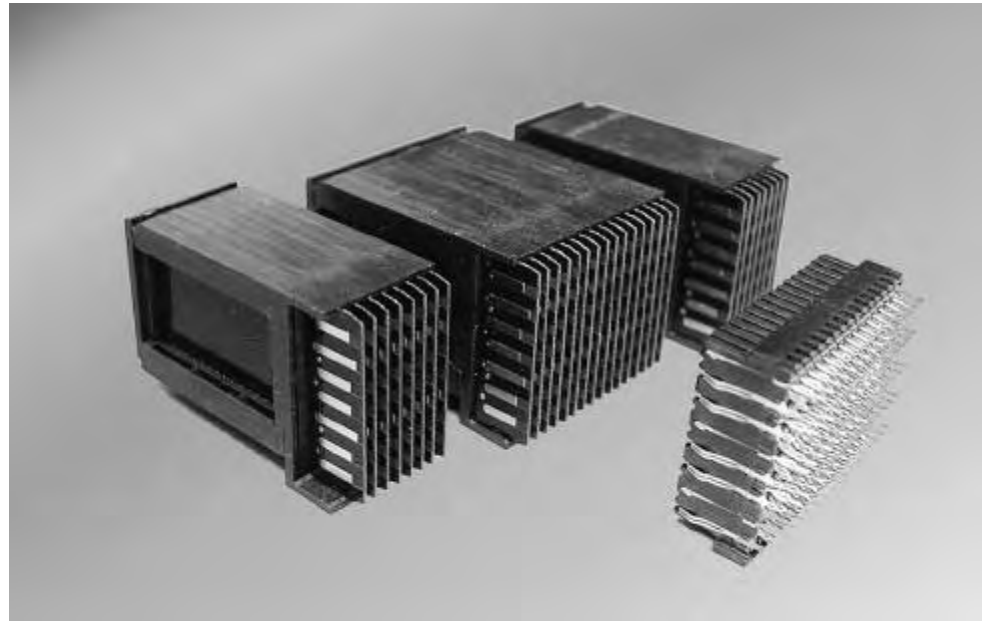

The MULTIGIG RT product line is a backplane interconnect family that offers flexibility and customization. This printed circuit based, pinless, interconnect family is comprised of modular components which can be used in a variety of combinations. The connectors in this innovatively flexible platform can be combined to provide the density, data throughput, and signal integrity required for applications in today's computer, military, medical, or industrial control industries. The use of printed circuit wafers in this connector system

allows for cost effective sequencing and electrical customization of the connector. Wafers can be manufactured specifically for differential or signal ended performance and the impedance, propagation delay, and crosstalk of the connector can be altered per customer requirements. This scalable board to backplane connector family is a robust, “pinless” design which eliminates the pin field on backplane boards and reduces the end user's exposure to field failure in card cage systems. The MULTIGIG RT connector

family is designed specifically for 20.30 [.800] or 25.40 [1.00] card pitch systems.

- **MULTIGIG RT 1 connector** — 141 signals/inch, data rates up to 3.125 Gb/s
- **MULTIGIG RT 2 connector** — 113 signals/inch, data rates of 3.125 Gb/s to 6.4+ Gb/s and has been demonstrated to support 10 Gb/s

www.multigigrt.com

Applications

- Telecommunications Equipment
 - Metro Optical Networking equipment
 - SONET switched platforms
 - Aggregation switches
- Midrange Servers
- High End Servers
- High speed custom platforms
- Mass data storage
- Rugged, mission-critical applications

Technical Documents

- Application Specifications**
 - 114-13062 Power Modules
 - 114-13056 Signal Connectors
- Product Specifications**
 - 108-2062 Power Modules
 - 108-2072 Signal Connectors
- Qualification Test Reports**
 - 501-538 Power Connectors
 - 501-544 Signal Connectors
- Engineering Report**
 - 502-1130 Power Connectors
 - Routing Guide RT 2 on te.com

MULTIGIG RT Connector Products (Continued)

MULTIGIG RT Connector Sequencing Chart

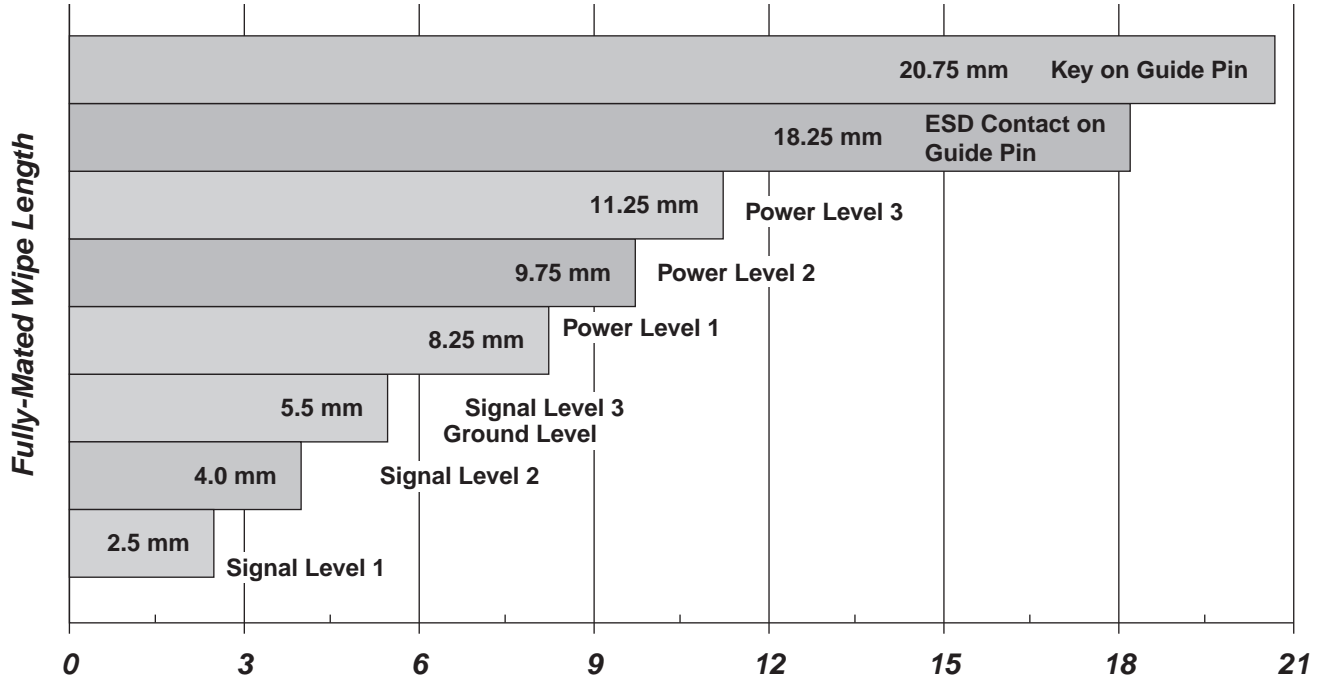

5
 MULTIGIG RT Connector

MULTIGIG RT Connector Products (Continued)

MULTIGIG RT Connector Mating Sequence Chart which shows the relationship of MULTIGIG RT Connector products with other TE products



Product Family	Dim. C	Dim. A Fully Mated	Contact	Dim B.		Fully Mated Wipe Length
				Reliable Mate	First Mate Last Break	
Z-PACK HM-Zd Product	1.50 .059	12.50 .492	Ground Shield	16.78 [.661]	17.55 [.691]	4.28 [.169]
			Signal Level 2	15.41 [.607]	15.85 [.624]	2.91 [.115]
			Signal Level 1	13.91 [.548]	14.35 [.565]	1.41 [.056]
Z-PACK HM-Zd Guide Hardware	3.00 .118	12.50 .492	24.0 mm Pin	27.50 [1.083]	33.40 [1.315]	N/A
			22.2 mm Pin	25.70 [1.012]	31.60 [1.244]	N/A
			Key Blocking Point	N/A	22.03 [.867]	N/A
Z-PACK TinMan Product	1.50 .059	12.50 .492	Ground Pins	16.44 [.647]	17.13 [.674]	3.94 [.155]
			Signal Level 2	14.94 [.588]	15.63 [.615]	2.44 [.096]
			Signal Level 1	N/A	N/A	N/A
Z-PACK 2mm HM Product	1.50 .059	12.50 .492	Signal Level 3	18.27 [.719]	18.84 [.742]	5.77 [.227]
			Signal Level 2	16.77 [.660]	17.34 [.683]	4.27 [.168]
			Signal Level 1	15.27 [.601]	15.84 [.624]	2.77 [.109]
MULTIGIG RT T1 Product	2.50 .098	12.50 .492	Ground	18.00 [.709]	—	5.50 [.217]
			Signal Level 3	18.00 [.709]	—	5.50 [.217]
			Signal Level 2	16.50 [.650]	—	4.00 [.157]
			Signal Level 1	15.00 [.591]	—	2.50 [.098]
MULTIGIG RT T2 Product	2.25 .089	12.50 .492	Ground	18.00 [.709]	—	5.50 [.217]
			Signal Level 3	18.00 [.709]	—	5.50 [.217]
			Signal Level 2	16.50 [.650]	—	4.00 [.157]
MULTIGIG RT Power Module	5.50 .217	12.50 .492	Power Level 3	23.75 [.935]	—	11.25 [.443]
			Power Level 2	22.25 [.876]	—	9.75 [.384]
			Power Level 1	20.75 [.817]	—	8.25 [.325]
MULTIGIG RT Guide Hardware	N/A	12.50 .492	Guide Pin Key	33.25 [1.309]	N/A	20.75 [.817]
			Guide ESD Contact	30.75 [1.211]	—	18.25 [.719]
Z-PACK HS3 Product	1.50 .059	12.50 .492	Ground	17.08 [.672]	17.60 [.693]	4.78 [.188]
			Signal Level 2	16.05 [.632]	16.47 [.648]	3.75 [.148]
			Signal Level 1	14.55 [.573]	14.97 [.589]	2.25 [.089]
UPM	3.50 .138	12.50 .492	Power Level 3	20.25 [.797]	20.95 [.825]	8.10 [.319]
			Power Level 2	18.65 [.734]	19.35 [.762]	6.50 [.256]
			Power Level 1	17.03 [.670]	17.73 [.698]	4.88 [.192]
UPM Guide Hardware	5.75 .226	12.50 .492	Guide Pin Key	31.39 [1.236]	36.16 [1.424]	N/A
			Keyed Guide Pin	31.39 [1.236]	36.16 [1.424]	N/A
			Keyed Guide Pin	35.23 [1.387]	40.00 [1.575]	N/A
MULTI-BEAM XL Right Angle Header to Vertical Receptacle	5.08 .200	14.73 .580	PreMate Power — Level 1	—	16.84 [.663]	5.61 [.221] Min.
			PostMate Power — Level 2	—	17.81 [.701]	4.34 [.171] Min.
			PreMate Signal — Level 2	—	18.26 [.719]	3.81 [.150] Min.
			PostMate Signal — Level 3	—	19.53 [.769]	2.54 [.100] Min.
MULTI-BEAM XL Right Angle Receptacle to Vertical Header	3.81 .150	13.21 .520	PreMate Power — Level 1	—	15.32 [.603]	5.61 [.221] Min.
			PostMate Power — Level 2	—	16.28 [.641]	4.34 [.171] Min.
			PreMate Signal — Level 2	—	16.74 [.659]	3.81 [.150] Min.
			PostMate Signal — Level 3	—	18.01 [.709]	2.54 [.100] Min.

MULTIGIG RT Connector Products (Continued)

Product Selection Guide

MULTIGIG RT connectors consist of interlocking left end and right end signal modules (half or full), center signal modules, and stand alone modules available in vertical receptacles (backplane application) and right angle plugs (daughtercard application), and complementary mechanical guide assemblies (available in size 10.80 [.425], 9.00 [.354] or 7.20 [.283]). The guide assembly provides blind mating and misalignment for the connectors. The 10.80 [.425] and 9.00 [.354] guide assembly also provides keying and is available with or without an internal contact for electrostatic discharge (ESD) protection.

The modules are capable of being stacked in any configuration within the limitations given in this catalog to a maximum length of 120 between guide assemblies. These connectors perform at two separate density levels: Tier 1 and Tier 2. The connectors are placed on the pc board by manually-operated or automatic machines.

The modules have 6, 8, or 10 rows of signal contacts with 20.30 [.800], 25.40 [1.000], or 9.00 [.354] centerline spacing (profile size). A right angle plug module having 7 rows with 20.30 [.800] spacing is also available for Tier 2 only to accommodate special

applications used by the VMEbus International Trade Association (VITA). The signal contacts, along with the ground contacts (in Tier 1 modules only) and ESD contacts (if using the 10.80 [.425] guide assembly with ESD contact) provide sequencing for each group of modules.

When corresponding with personnel, use the terminology provided to facilitate your inquiries for information. Basic terms and features of this product are provided in the art below and on the following page.

Vertical Receptacle (Backplane) Connector

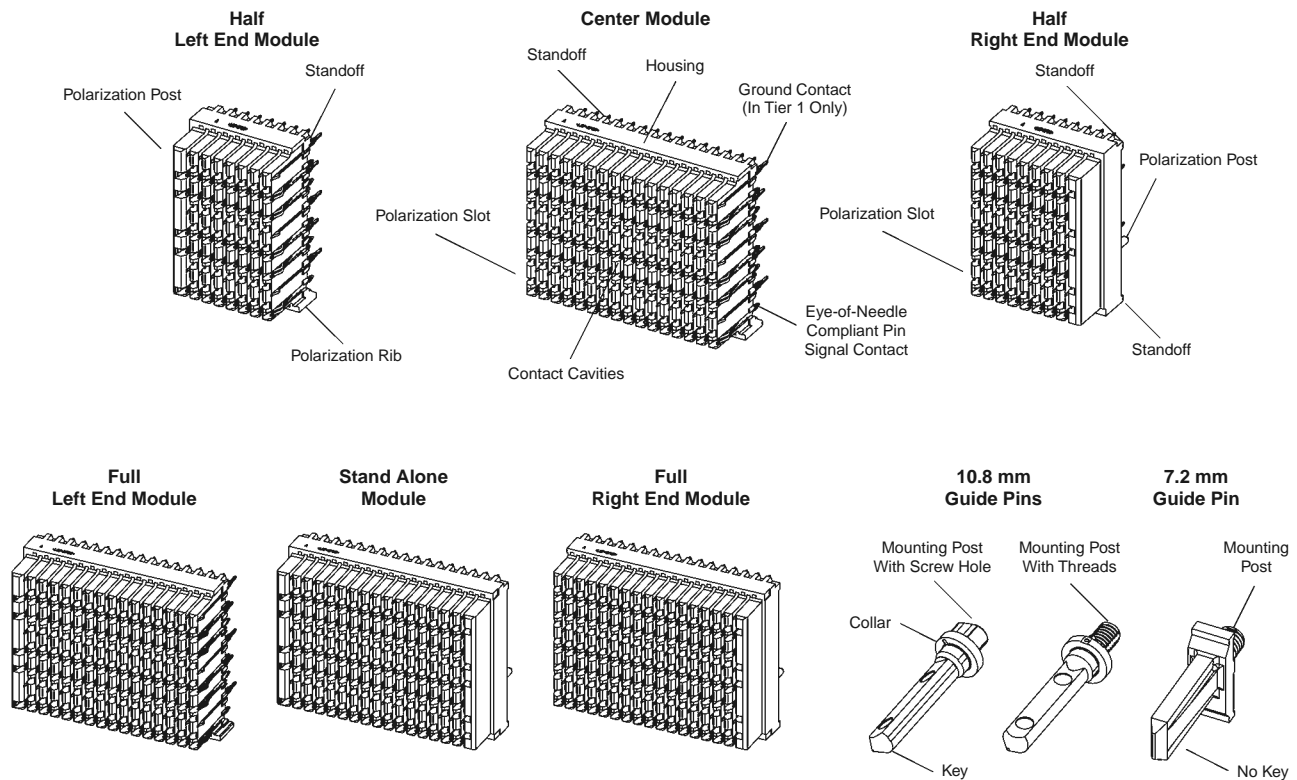

VITA, VMEbus, VPX, and VXS are trademarks of VITA.

MULTIGIG RT Connector Products (Continued)

Product Selection Guide

(Continued)

Right Angle Plug (Daughtercard) Connector

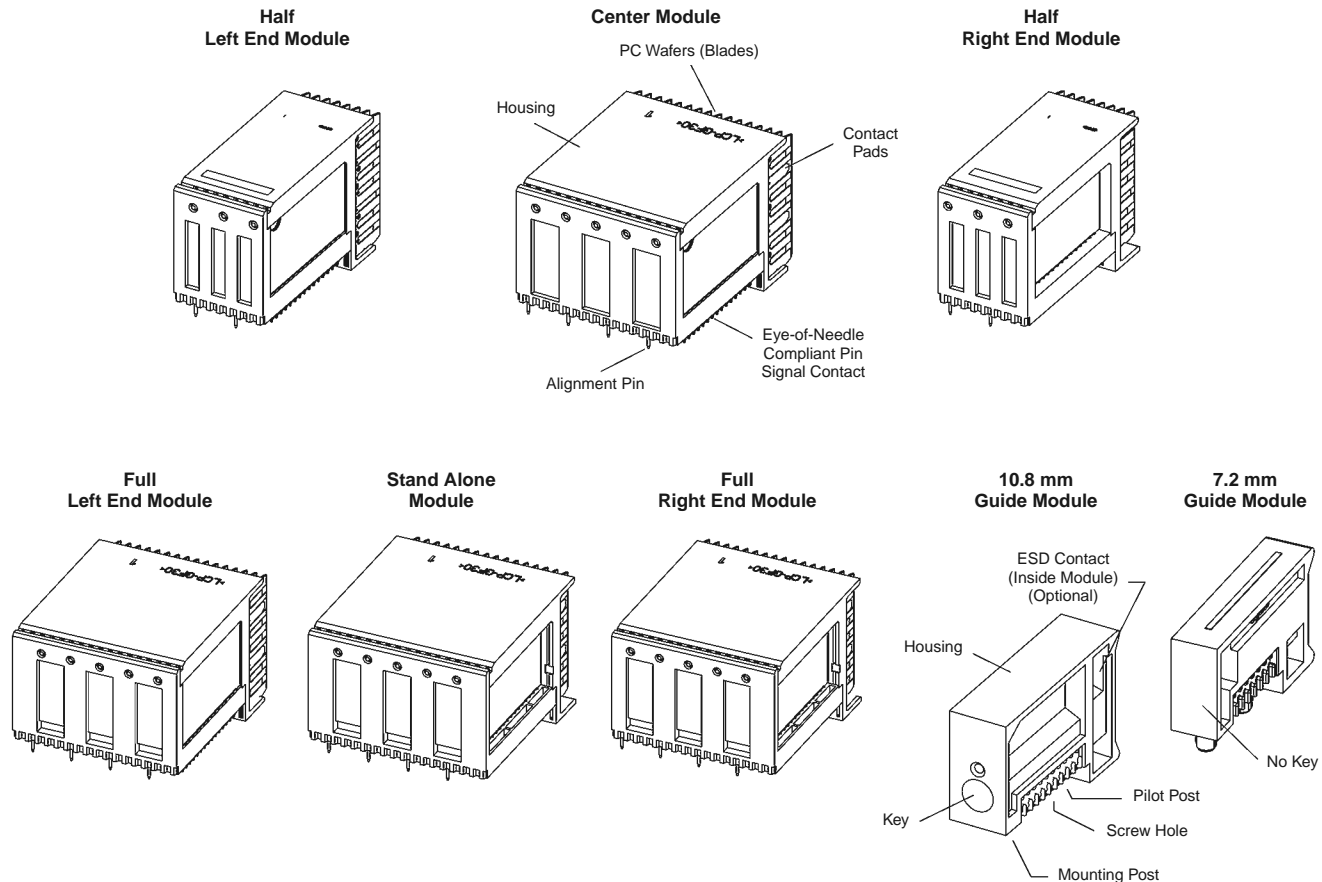

Signal Modules

Tier 1 and Tier 2 receptacles contain eye-of-needle compliant pin signal contacts; the Tier 1 receptacle also contains ground contacts. Each housing features standoffs for thermal venting, polarization ribs (on end modules) and polarization slots (on the center module) for proper stacking of the modules, and polarization posts to ensure correct orientation on the pc board.

Plugs contain eye-of-needle compliant pin signal contacts and pc wafers (blades). The housing features alignment pins to ensure correct orientation on the pc board.

Guide Assemblies

The guide assembly consists of a guide pin (used with receptacles) and a guide module (used with plugs).

The guide pin features a collar and mounting post

(having a screw hole or threads) with or without a key. The guide pins are available with various length mounting posts. The mounting post is used with customer supplied hardware to attach the guide pin to the pc board. Guide pins must be chosen according to thickness of pc board being used; otherwise, interference with proper mating or damage to system components will occur. Guide pins with keys are available in various keying positions.

The guide module features a housing with or without a key and with a screw hole, mounting post, and pilot post. The mounting post and pilot post are used to position the guide module on the pc board, and the screw hole is used with customer supplied hardware to attach the module to the pc board. The 10.80 [.425] and 9.00 [.354] guide module is available with or without an ESD contact located inside the module.

MULTIGIG RT Connector Products (Continued)

Product Selection Guide

(Continued)

Possible Module Configurations Used with Power Modules

Three Signal Modules and One Power Module

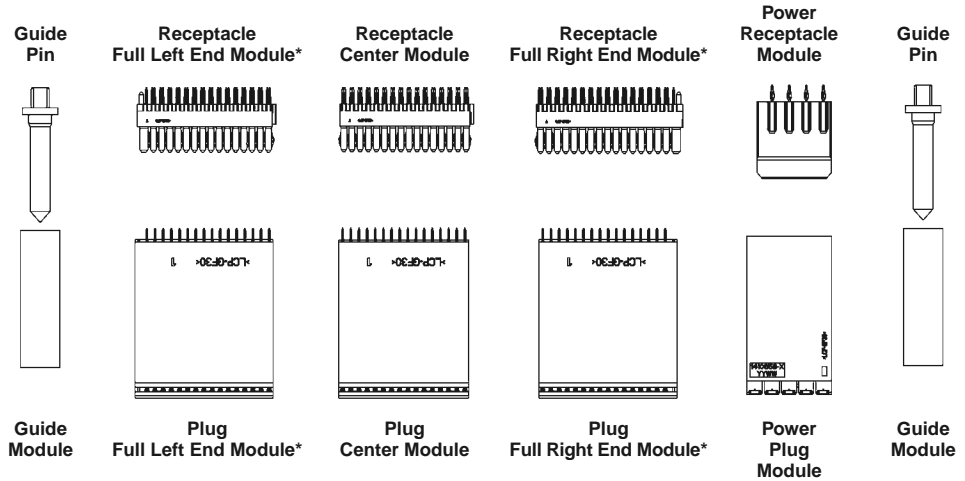

Two and One-Half Signal Modules and One Power Module

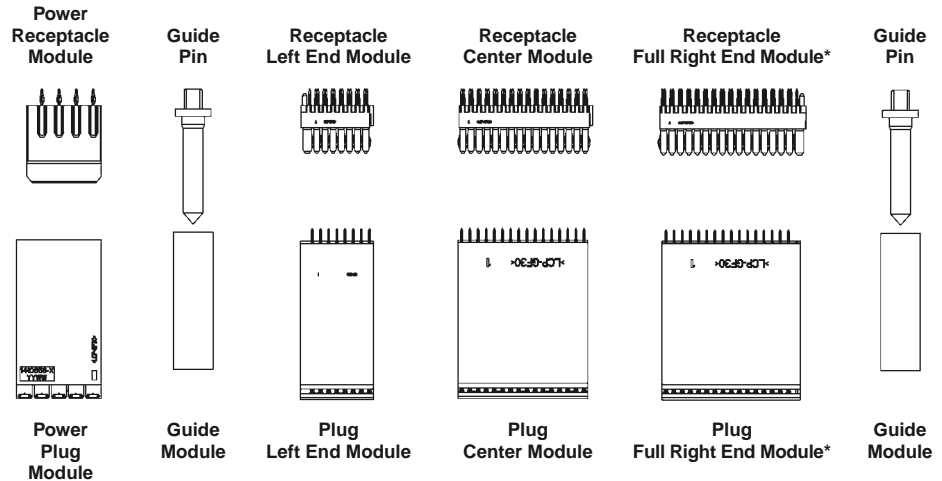

Four Signal Modules with One Power Module

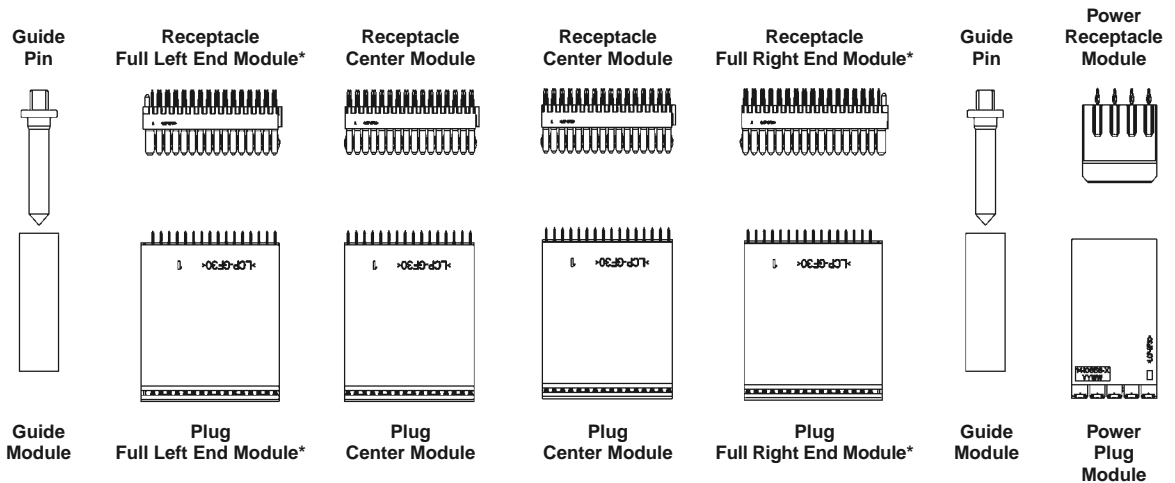

* A Half Left End Module and a Half Right End Module can be used instead.

MULTIGIG RT Connector Products (Continued)

Customization Options

The MULTIGIG RT product line is fully customizable. This is accomplished by means of stacking the PCB wafers in the correct location to achieve the desired mix of high speed differential, high speed single-ended, and low

speed/high speed density signals. In addition, power can be carried through the PCB wafers by replacing one or more signal wafers for a power wafer.

Shown below is a TE proposal for a typical

MULTIGIG RT connector application. As you can see, we took full advantage of the MULTIGIG RT connector capabilities. Contact your TE representative to have a proposal drawn-up to meet your specific needs.

Typical MULTIGIG RT Connector Implementation

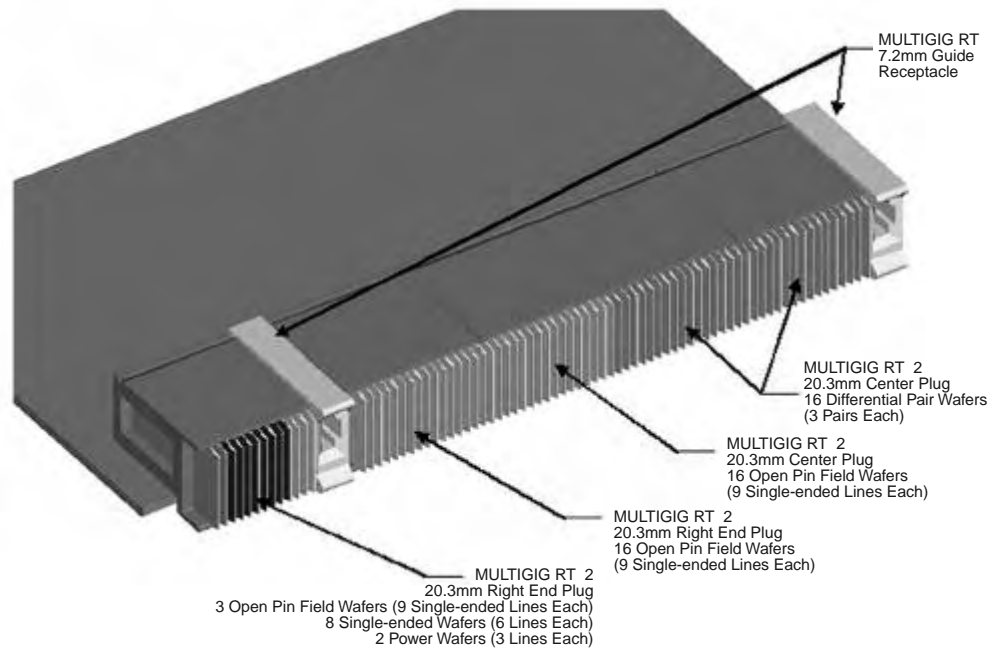

MULTIGIG RT Connector Products (Continued)

Customization Options

(Continued)

Tier 1 Options

The Tier 1 connector system can be customized with Differential and Single-ended wafers. In addition, a power wafer is available for the 25.40 [1.000] pitch

product that provides 4 power lines and 2 sense lines per wafer. Shown below are differential, single-ended and power options.

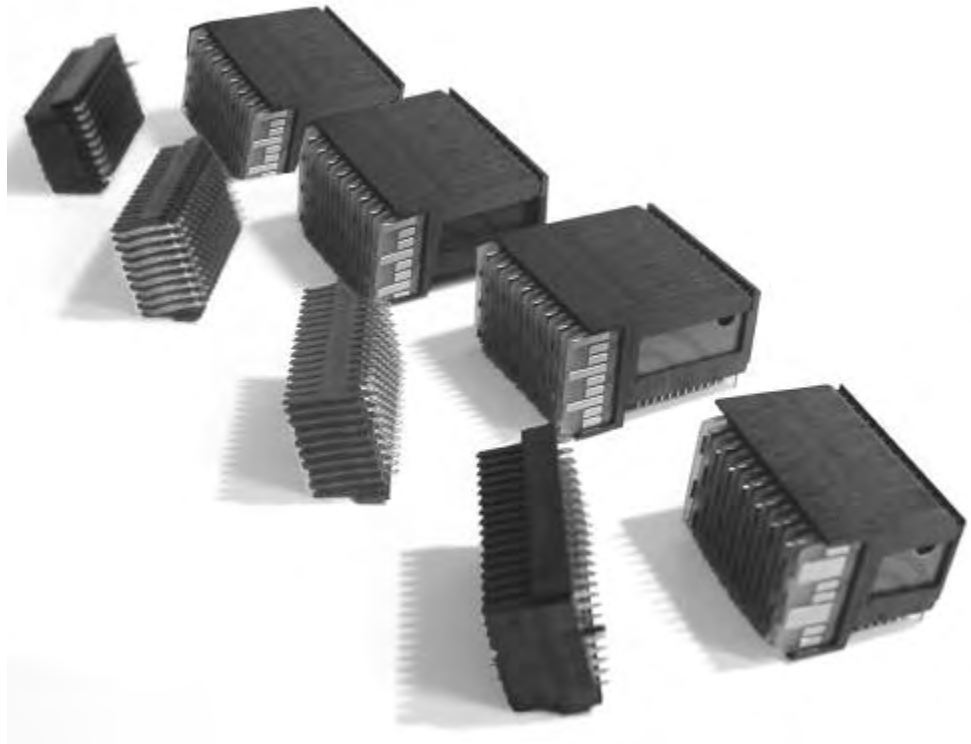

5

MULTIGIG RT Connector

MULTIGIG RT Connector Products (Continued)

Customization Options

(Continued)

Tier 2 Options

The Tier 2 connector system is fully customizable due to the lack of a bussed ground system. This allows us to stack the many options available (with more being developed as needed) in any configuration that is necessary to meet the customers needs. Shown here are some of the options that are currently available.

**Signal Options Available:
0.8" Shown**

Differential Wafers

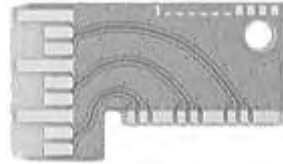

Single-ended w/ 1:1 S/G Ratio

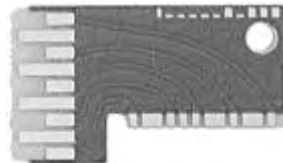

Single-ended w/ 2:1 S/G Ratio

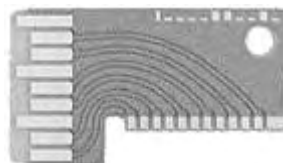

**Open Pin Field
(No Reference Ground)**

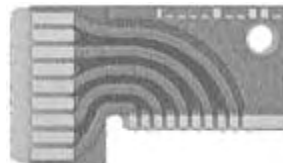

Mixed, Differential and S/E Lines

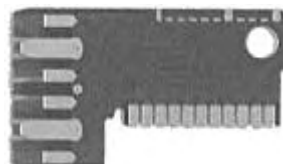

Custom, VITA 41, Mixed



**Up to 4 Power Lines/Wafer
Total of 19 AMPS/Wafer**

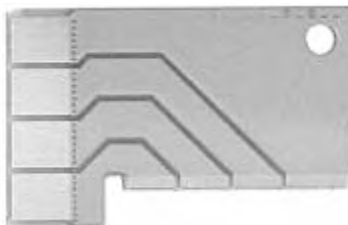

VITA, VMEbus, VPX, and VXS are trademarks of VITA.

MULTIGIG RT Tier 1 Connector System

Target Applications

- High speed telecommunications equipment
- Midrange and high-end servers
- Networking equipment
- Blindmate design
- High speed custom platforms
- Mass data storage
- Rugged, mission-critical applications

Product Features

- Excellent performance to 3.125 Gb/s
- High density: 140 contacts per inch provides 70 contact pairs per inch for differential signaling
- Options include 20.32 [.800] and 25.40 [1.000] pitch card spacing
- Modular options for signal, power, keying and guidance
- Optimized footprints
- Robust design
- Low noise levels
- Supports differential pair widths of 6 mils with 9 mil spacings
- Single-ended option available; contact TE for performance data

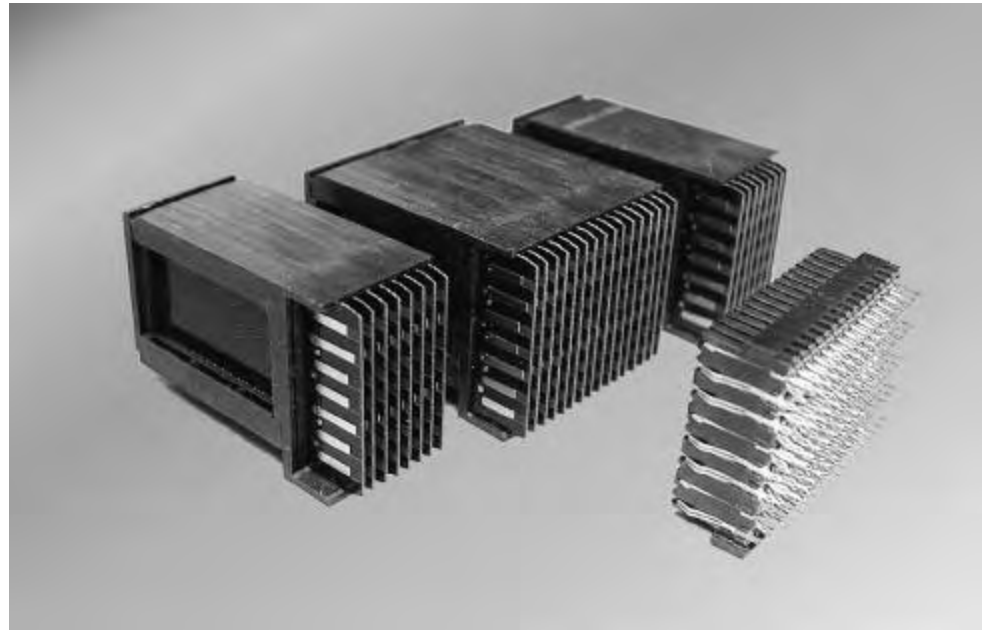

The MULTIGIG RT Tier 1 connector meets customer requirements for high-density and high-performance two-piece interconnects. In TE and independent lab tests, the MULTIGIG RT Tier 1 connector has performed in excess of 3 Gb/s using standard FR-4 board material and routing techniques.

The MULTIGIG RT Tier 1 connector is a differential connector with a contact density of 70 pairs per inch. The robust connector uses daughtercard plugs with a printed circuit board (PCB)

wafer design and backplane receptacles with a completely enclosed dual-beam design. All signal lines use redundant points of contact for high reliability.

The MULTIGIG RT Tier 1 connector is available for both 20.32 [.800] and 25.40 [1.000] pitch card spacing. The totally modular system allows flexibility in choosing signal and power modules as well as guidance, keying, and electrostatic discharge (ESD) modules to meet the most demanding applications. Signal modules can

be customized for specific electrical requirements — such as sequencing — that are critical in high speed applications.

Power modules are available with two- and four-voltage options, each circuit capable of carrying 20 amps. The robust metal guide pin provides eight keying options and a unique ESD contact to discharge static when daughtercards are hot-plugged.

Availability

Fully validated SPICE models: E-mail requests to modeling@te.com

Pro/E models and IGES models: E-mail requests to TECAD@te.com

www.te.com

IGES is a trademark of IAMBA Networks, Inc.

PRO/E is a trademark of Parametric Technology Corp.

MULTIGIG RT Tier 1 Connector System (Continued)

Mechanical Design Summary

Mechanical Features

- Extremely rugged connector for mission critical applications
- Three signal sequencing levels plus an additional three power sequencing levels
- Keyed guide modules standard: cannot mate connector incorrectly, and provide ± 3 mm of gather
- Options available include:
 - Power modules
 - Electrostatic discharge guide pins
 - Multiple guide pin keying options
- High signal density: 70 pairs for differential signals

20.30 [.800] Pitch Connector

Type	Style	No. of Cols.	Signal Pattern	Part Number
(Backplane) Receptacle	Center	16	N/A	1410200-1
	Stand Alone	16	N/A	1410420-1
	Half Left	8	N/A	1410226-1
	Half Right	8	N/A	1410227-1
	Full Left	16	N/A	1410201-1
	Full Right	16	N/A	1410202-1
(Daughtercard) Plug	Center	16	S.E.	1410205-1
		16	Diff.	1410205-2
	Stand Alone	16	S.E.	1410421-1
		16	Diff.	1410421-2
	Half Left	8	S.E.	1410228-1
		8	Diff.	1410228-2
	Half Right	8	S.E.	1410229-1
		8	Diff.	1410229-2
	Full Left	16	S.E.	1410206-1
		16	Diff.	1410206-2
	Full Right	16	S.E.	1410207-1
		16	Diff.	1410207-2

25.40 [1.00] Pitch Connector

Type	Style	No. of Cols.	Signal Pattern	Part Number
(Backplane) Receptacle	Center	16	N/A	1410210-1
	Stand Alone	16	N/A	1410412-1
	Half Left	8	N/A	1410231-1
	Half Right	8	N/A	1410230-1
	Full Left	16	N/A	1410211-1
	Full Right	16	N/A	1410212-1
(Daughtercard) Plug	Center	16	S.E.	1410215-1
		16	Diff.	1410215-2
	Stand Alone	16	S.E.	1410413-1
		16	Diff.	1410413-2
	Half Left	8	S.E.	1410232-1
		8	Diff.	1410232-2
	Half Right	8	S.E.	1410233-1
		8	Diff.	1410233-2
	Full Left	16	S.E.	1410216-1
		16	Diff.	1410216-2
	Full Right	16	S.E.	1410217-1
		16	Diff.	1410217-2

The drawings below show the nominal dimensions for the MULTIGIG RT 1 connector modules

Dim.	20.32 [.800] Connector	25.40 [1.000] Connector
A	16.10 .630	16.10 .630
B	21.60 .850	27.40 1.080
C	18.40 .720	24.20 .950
D	28.70 1.130	28.70 1.130
E	21.60 .850	27.40 1.080
F	18.40 .720	24.20 .950

Dim.	20.32 [.800] Connector	25.40 [1.000] Connector
AA	R = 17.00 .067 L = 15.20 .600	R = 17.00 .067 L = 15.20 .600
BB	10.50 .410	10.50 .410
CC	18.60 .730	24.40 .960
DD	28.70 1.130	28.70 1.130
EE	10.50 .410	10.50 .410
FF	18.60 .730	24.40 .960

Left/Right End Module

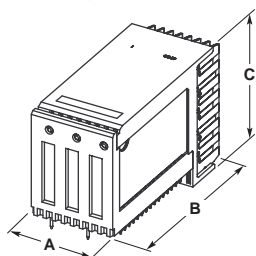

Center Module

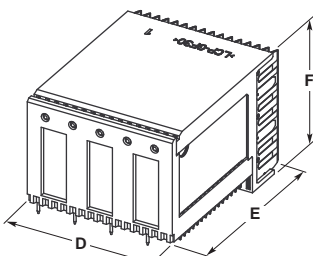

Left Full End Module

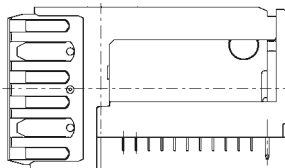

Right Full End Module

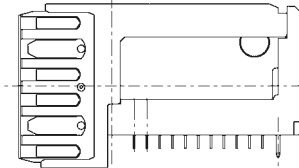

Plug (Daughtercard)

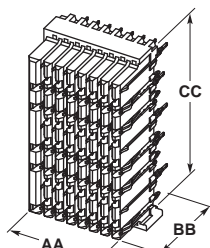

Receptacle (Backplane)

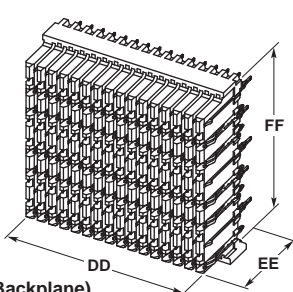

Stand Alone Backplane

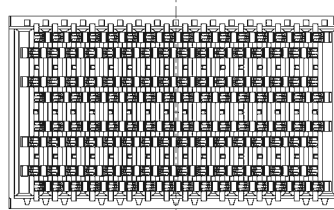

Stand Alone Daughtercard

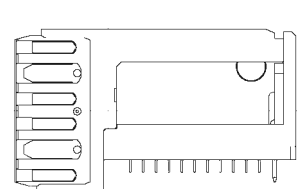

Note: All part numbers are RoHS compliant.

MULTIGIG RT Tier 2 Connector System

Target Applications

- High speed telecommunications equipment
- Midrange and high-end servers
- Networking equipment
- Blindmate design
- High speed custom platforms
- Mass data storage
- Rugged, mission-critical applications

Product Features

- Excellent performance to 6.25+ Gb/s—
- High density: 113 contacts per inch provides 56 contact pairs per inch for differential signaling
- Options include 20.32 [.800] and 25.40 [1.000] pitch card spacing
- Modular options for signal, power, keying and guidance
- Optimized footprints
- Robust design
- Low noise levels
- Supports differential pair widths of 6 mils with 9 mil spacings
- Single-ended, open pin field and power wafers available

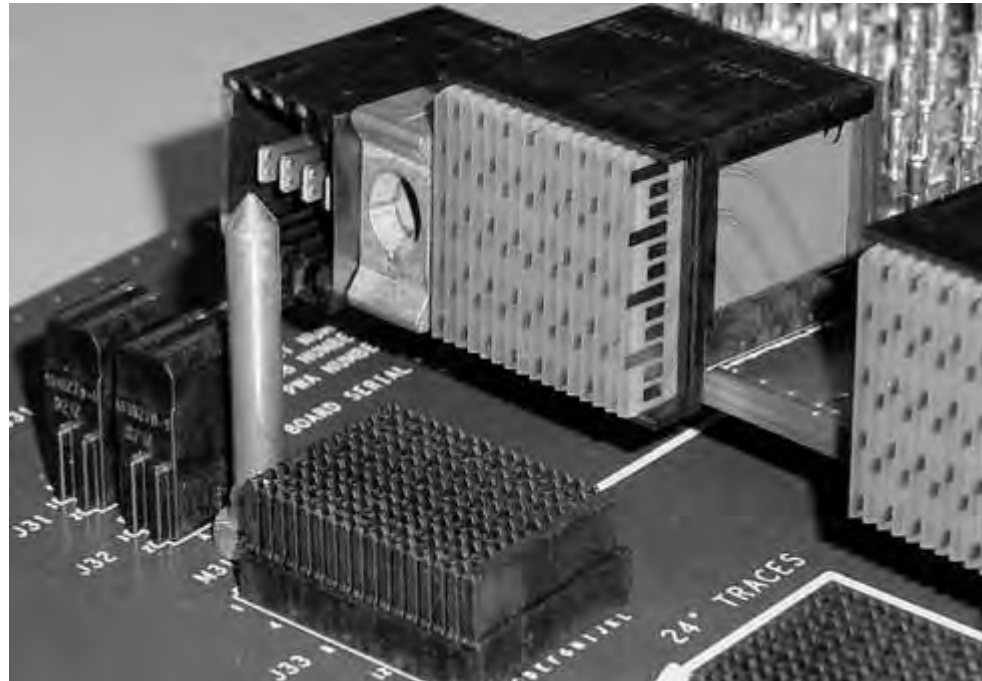

The MULTIGIG RT Tier 2 connector is the latest product release to meet customer requirements for high-density and high-performance two-piece interconnects. In TE and independent lab tests, the MULTIGIG RT Tier 2 connector has performed in excess of 6 Gb/s using standard FR-4 board material and routing techniques, and has **been demonstrated to 10 Gb/s**.

The MULTIGIG RT Tier 2 connector system provides the flexibility to configure the daughtercard for Differential, Single-ended, Open Pin Field, or Power

within a single connector module. All of these options then mate into a common Backplane Receptacle.

The robust connector uses daughtercard plugs with a printed circuit board (PCB) wafer design and backplane receptacles with a completely enclosed dual-beam design. All signal lines use redundant points of contact for high reliability.

The MULTIGIG RT Tier 2 connector is available for both 20.32 [.800] and 25.40 [1.000] pitch card spacing. The totally modular system allows flexibility in choosing signal and power modules as well as guidance, keying,

and electrostatic discharge (ESD) modules to meet the most demanding applications. Signal modules can be customized for specific electrical requirements — such as sequencing — that are critical in high speed applications.

Power modules are available with two- and four-voltage options, each circuit capable of carrying 20 amps. The robust metal guide pin provides eight keying options and a unique ESD contact to discharge static when daughtercards are hot-plugged.

Availability

Fully validated SPICE models: E-mail requests to modeling@te.com

Pro/E models and IGES models: E-mail requests to TECAD@te.com

www.te.com

IGES is a trademark of IAMBA Networks, Inc.

PRO/E is a trademark of Parametric Technology Corp.

MULTIGIG RT Tier 2 Connector System (Continued)

Mechanical Design Summary

20.30 [.800] Pitch Connector

Type	Style	No. of Cols.	Signal Pattern	Part Number
(Backplane) Receptacle	Center	16	N/A	1410140-1
	Stand Alone	16	N/A	1410133-1
	Half Left	8	N/A	1410186-1
	Half Right	8	N/A	*
	Full Left	16	N/A	1410141-1
	Full Right	16	N/A	1410142-1
	Right End	18	N/A	1410456-1
(Daughtercard) Plug	Center	16	S.E.	*
		16	Diff.	1410137-1
	Stand Alone	16	S.E.	*
		16	Diff.	1410134-1
	Half Left	8	S.E.	*
		8	Diff.	*
	Half Right	8	S.E.	*
		8	Diff.	*
	Full Left	16	S.E.	*
		16	Diff.	1410138-1
	Full Right	16	S.E.	*
	16	Diff.	1410139-1	

25.40 [1.00] Pitch Connector

Type	Style	No. of Cols.	Signal Pattern	Part Number
(Backplane) Receptacle	Center	16	N/A	1410127-1
	Stand Alone	16	N/A	1410131-1
	Half Left	8	N/A	*
	Half Right	8	N/A	*
	Full Left	16	N/A	1410129-1
	Full Right	16	N/A	1410128-1
	Center	16	S.E.	*
(Daughtercard) Plug		16	Diff.	1410123-1
	Stand Alone	16	S.E.	*
		16	Diff.	1410132-1
	Half Left	8	S.E.	*
		8	Diff.	*
	Half Right	8	S.E.	*
		8	Diff.	*
	Full Left	16	S.E.	*
		16	Diff.	1410124-1
	Full Right	16	S.E.	*
		16	Diff.	1410125-1

* Contact TE.

* Contact TE.

The drawings below show the nominal dimensions for the MULTIGIG RT 2 connector modules

Dim.	20.32 [.800] Connector	25.40 [1.000] Connector
A	16.10 .630	16.10 .630
B	21.60 .850	27.40 1.080
C	18.40 .720	24.20 .950
D	28.70 1.130	28.70 1.130
E	21.60 .850	27.40 1.080
F	18.40 .720	24.20 .950

Dim.	20.32 [.800] Connector	25.40 [1.000] Connector
AA	R = 17.00 .067 L = 15.20 .600	R = 17.00 .067 L = 15.20 .600
BB	10.50 .410	10.50 .410
CC	18.60 .730	24.40 .960
DD	28.70 1.130	28.70 1.130
EE	10.50 .410	10.50 .410
FF	18.60 .730	24.40 .960

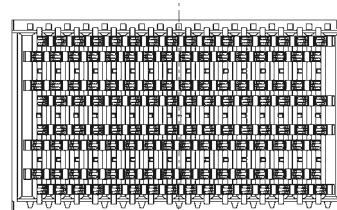
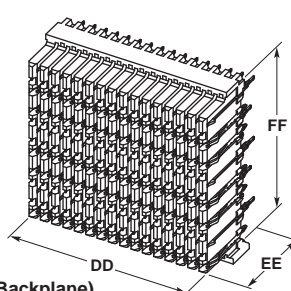
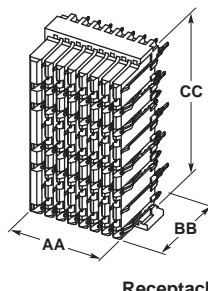
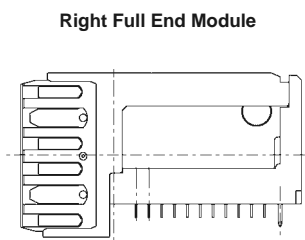
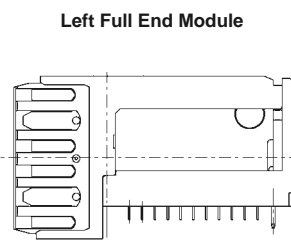
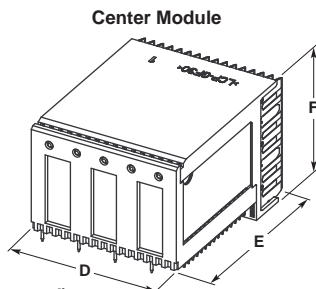
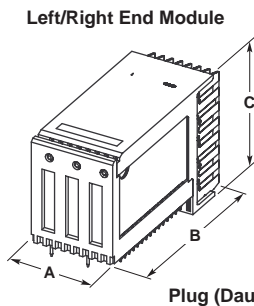

Note: All part numbers are RoHS compliant.

Connector Selection Grid for VITA 41 VXS Compliant Connectors

Product Facts

- 10+ Gbps performance
- Differential, Single-ended and Power
- Customizable impedance matched printed circuit wafer interface
- Backplane connector system with “pinless” interface
- Superior crosstalk performance
- Optimized footprints for signal integrity and ease of board design
- Utilizes a 0.56 [.022] diameter via for backplane connector for lower cost board fabrication
- Three levels of signal contact sequencing
- Modular connector system
- Available for 20.30 [.800] or 25.40 [1.00] card pitch systems
- Provides ESD protection
- Complete connector family includes...
 - Power Modules
 - Guidance Modules

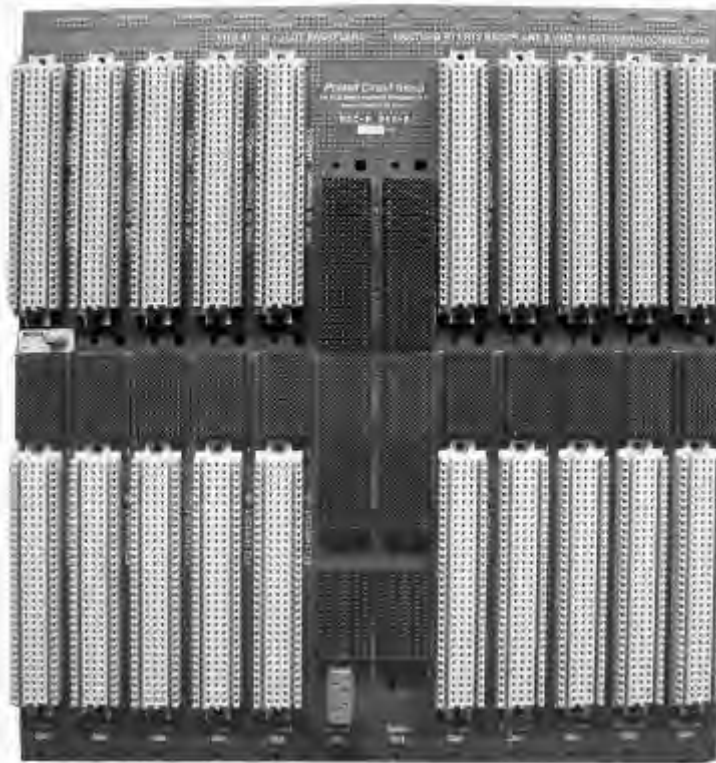

The VITA 41 VXS product line is a backplane interconnect family that offers flexibility and customization. VXS is an ANSI standard that combines parallel VMEbus technology with enhancements to support switched serial fabrics including PCI Express, RapidIO, StarFabric and InfiniBand over a new high speed P0 connector. Backward compatibility is maintained with existing backplanes that do not have

a conflicting P0 scheme. Combining the VME2eSST parallel bus with switch fabric technologies for multi-point, high-speed data transfers creates choices for embedded computing designs of all types. Under the VITA 41 VXS specification, VMEbus cards (now called “payload cards”) are connected via a high-speed P0 connector. Each payload card has two 4x VXS ports (port A and port B) to connect to other boards in the

system. Each VXS port is comprised of 4 HSS links running at speeds up to 2.5Gbps or 3.125Gbps.

Applications

- Military
- Aerospace and Defense
- Rugged, mission critical applications
- Mass data storage
- High-end and mid-range servers
- Telecommunications equipment

INFINIBAND is a trademark of the InfiniBand Trade Association.
 PCI Express is a trademark of PCI-SIG.
 RAPIDIO is a trademark of RAPIDIO, Inc.
 STARFABRIC is a trademark of StarGen, Inc.
 VITA, VMEbus, VPX, and VXS are trademarks of VITA.
 Check out the website
<http://www.vita.com/vso-stds.html>

Connector	Description	Part Number
P0	Tier 2, 7 Row, Center Module, 20.30 [.800] Pitch, Right Angle	1410147-1
P5	Tier 2, Left End Module, 20.30 [.800] Pitch, Right Angle	1410138-1
P4	Tier 2, Center Module, 20.30 [.800] Pitch, Right Angle	1410137-1
P3	Tier 2, Center Module, 20.30 [.800] Pitch, Right Angle	1410137-1
P2	Tier 2, Right End Module, 20.30 [.800] Pitch, Right Angle	1410139-1
P1	Tier 1, Monolithic, 20.30 [.800] Pitch, Right Angle	1410421-1

Connector	Description	Part Number
J0	Tier 2, Center Module, 20.30 [.800] Pitch, Vertical	1410135-1
J5	Tier 2, Left End Module, 20.30 [.800] Pitch, Vertical	1410141-1
J4	Tier 2, Center Module, 20.30 [.800] Pitch, Vertical	1410140-1
J3	Tier 2, Center Module, 20.30 [.800] Pitch, Vertical	1410140-1
J2	Tier 2, Right End Module, 20.30 [.800] Pitch, Vertical	1410142-1
J1	Tier 1, Monolithic Module, 20.30 [.800] Pitch, Vertical	1410420-1

Note: All part numbers are RoHS compliant.

Connector Selection Grid VITA 41 VXS Compliant Connectors (Continued)

Payload Board and Payload Slot

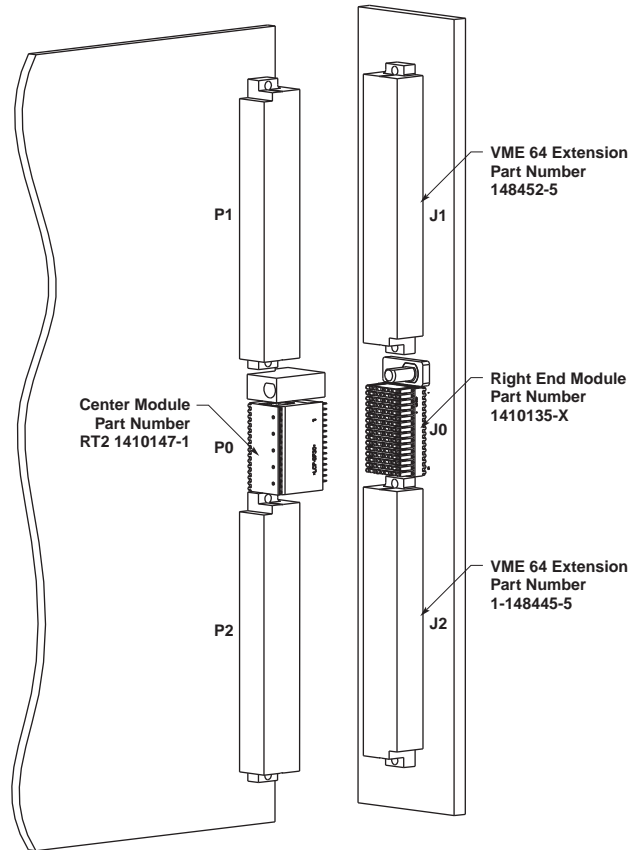

Switch Board and Switch Slot

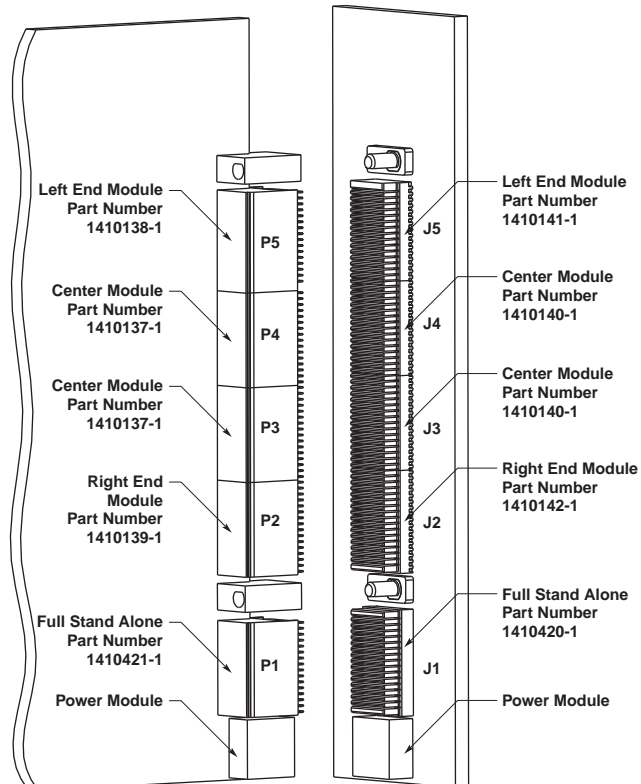

VITA, VMEbus, VPX, and VXS are trademarks of VITA. Check out the website <http://www.vita.com/vso-stds.html>

Note: All part numbers are RoHS compliant.

Connector Selection Grid VITA 41 VXS Compliant Connectors (Continued)

**VXS VMEbus
Switched Serial Payload
Rear Transition Module**

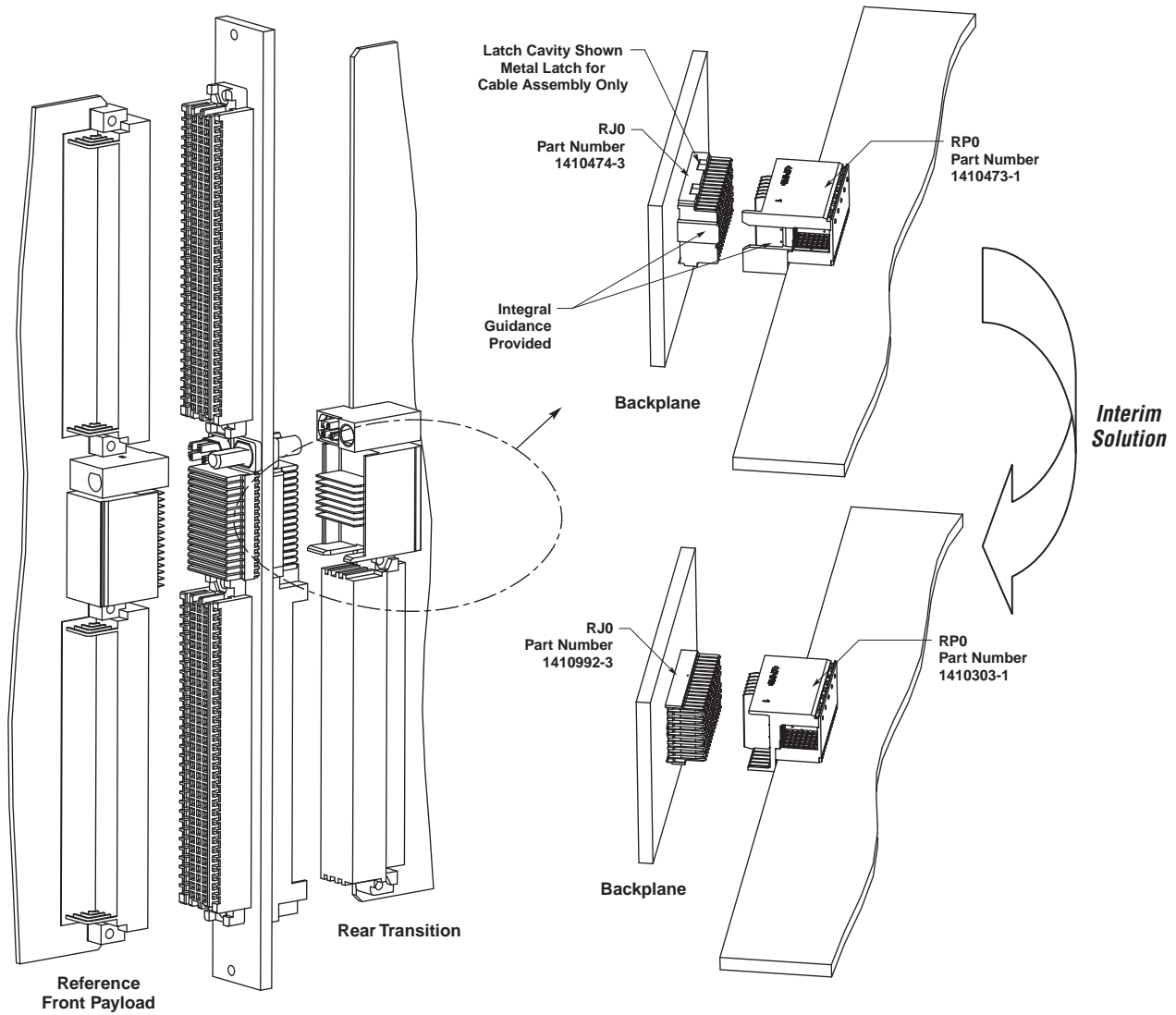

5
MULTIGIG RT Connector

VITA, VMEbus, VPX, and VXS are trademarks of VITA. Check out the website <http://www.vita.com/vso-stds.html>

Note: All part numbers are RoHS compliant.

Connector Selection Grid for VITA 46 VPX Compliant Connectors

Product Facts

- 10+ Gbps performance
- Differential, Single-ended and Power
- Customizable impedance matched printed circuit wafer interface
- Backplane connector system with “pinless” interface
- Superior crosstalk performance
- Optimized footprints for signal integrity and ease of board design
- Utilizes a 0.56 [.022] diameter via for backplane connector for lower cost board fabrication
- Three levels of signal contact sequencing
Modular connector system
- Available for 20.30 [.800] or 25.40 [1.00] card pitch systems
- Provides ESD protection
- Complete connector family includes...
 - Power Modules
 - Guidance Modules

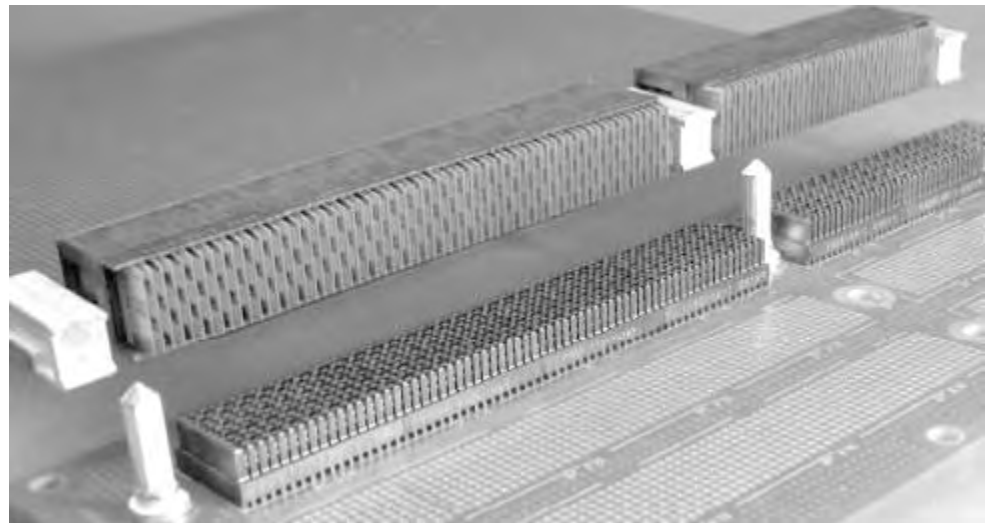

The VITA 46 VPX product line is a backplane interconnect family that offers levels of flexibility and customization never before seen in the industry. VPX provides high-speed data rates that traditional VME is not designed for; by merging the latest packaging and connector technology with the latest bus and serial technology.

This printed circuit based, pinless, interconnect family is comprised of modular components which can be used in a variety of combinations. VPX dramatically increases bandwidth with fewer pin counts and enables heterogeneous architectures to help preserve existing investments in technology and systems. The MULTIGIG RT product offers new 7-row high-speed connector modules that support VPX data rates.

Applications

- Military
- Aerospace and Defense
- Rugged, mission critical applications
- Mass data storage
- High-end and mid-range servers
- Telecommunications equipment

VITA, VMEbus, VPX, and VXS are trademarks of VITA. Check out the website <http://www.vita.com/vso-stds.html>

Connector Selection Grid for VITA 46 VPX Compliant Connectors (Continued)

VITA 46 VPX Compliant Connectors

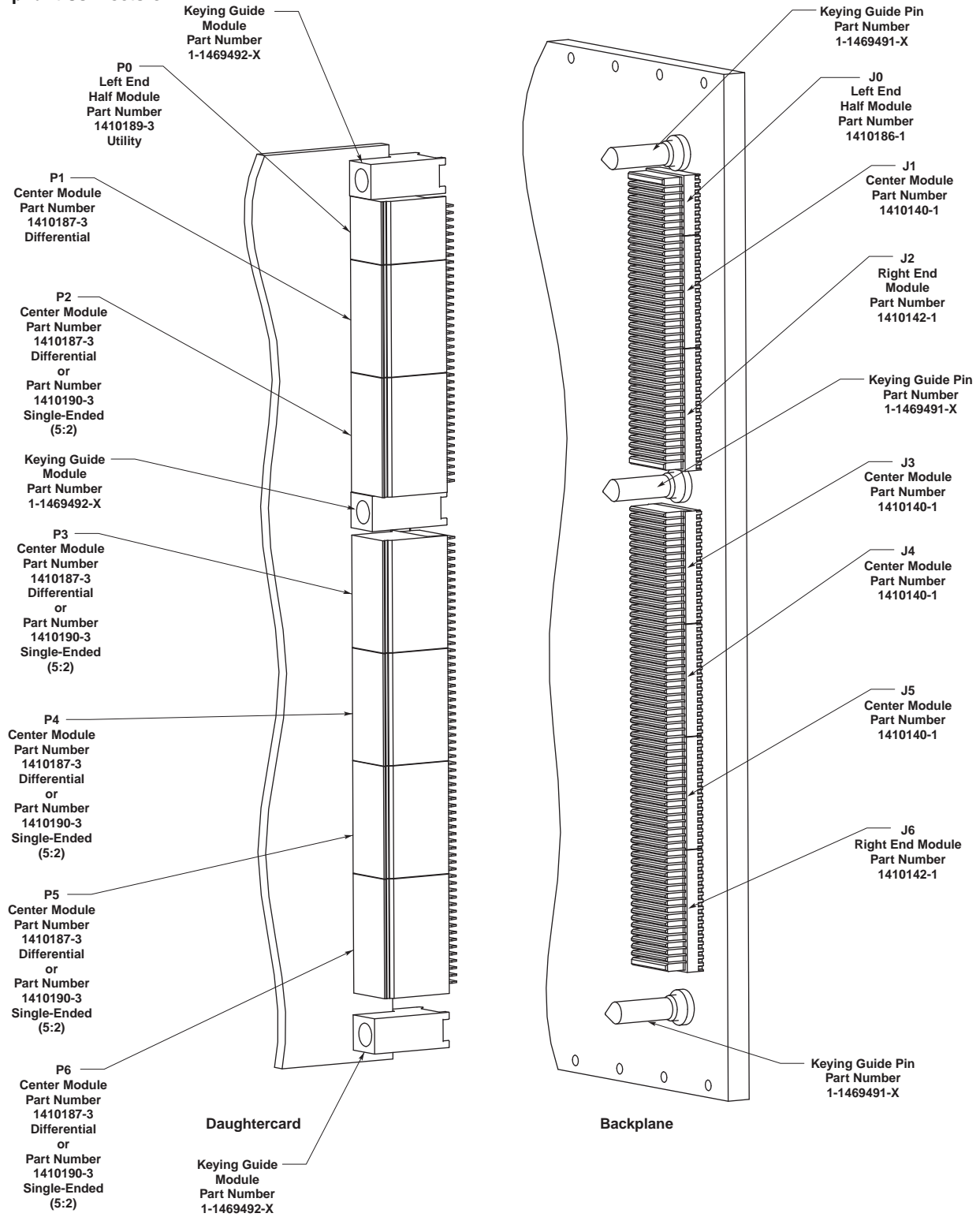

5 MULTIGIG RT Connector

VITA, VMEbus, VPX, and VXS are trademarks of VITA. Check out the website <http://www.vita.com/vso-stds.html>

Note: All part numbers are RoHS compliant.

Connector Selection Grid for VITA 46 VPX Compliant Connectors (Continued)

Rear Transition Module

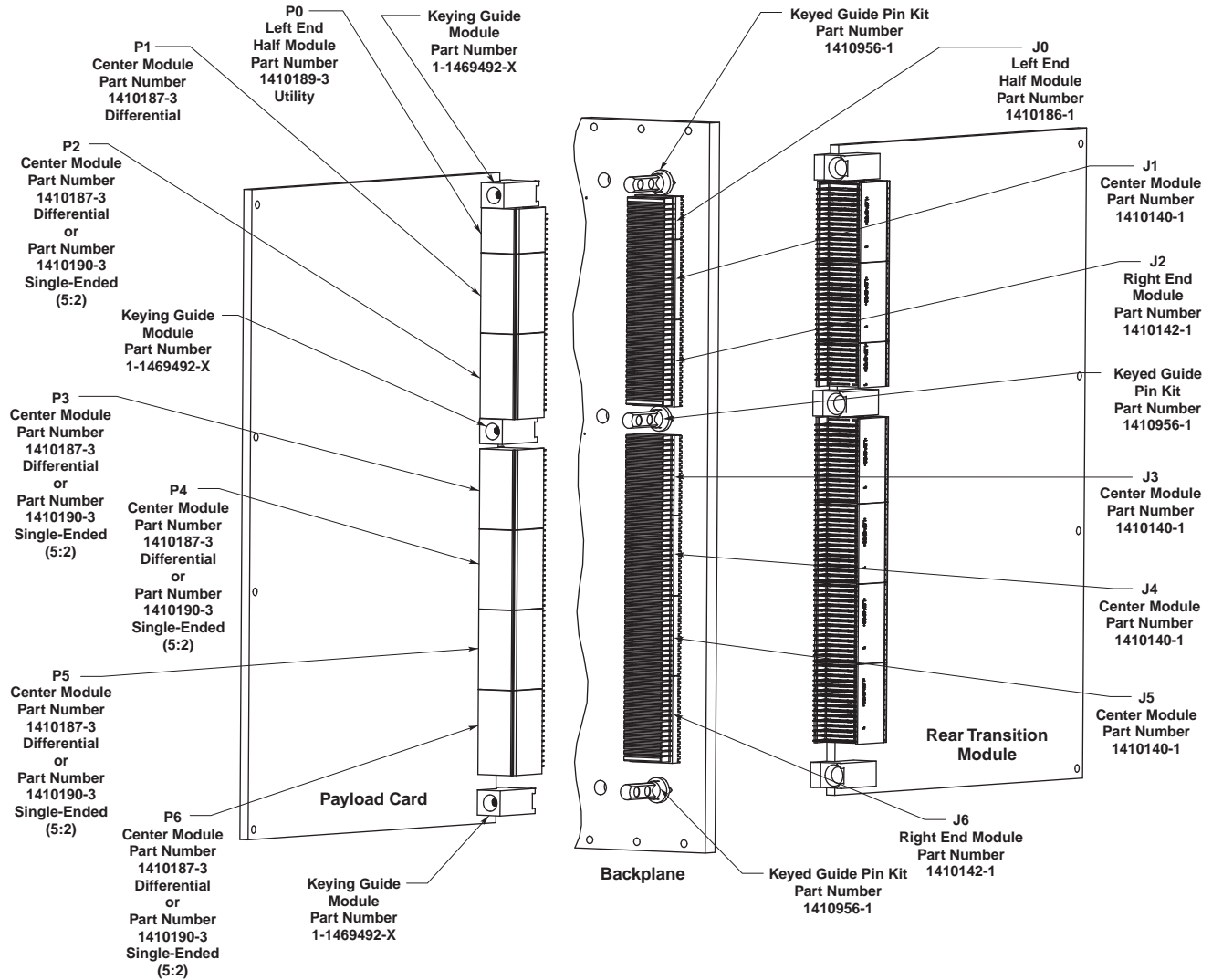

VITA, VMEbus, VPX, and VXS are trademarks of VITA. Check out the website <http://www.vita.com/vso-stds.html>

Note: All part numbers are RoHS compliant.

Connector Selection Grid for VITA 46 VPX Compliant Connectors (Continued)

Rear Transition Module

(Continued)

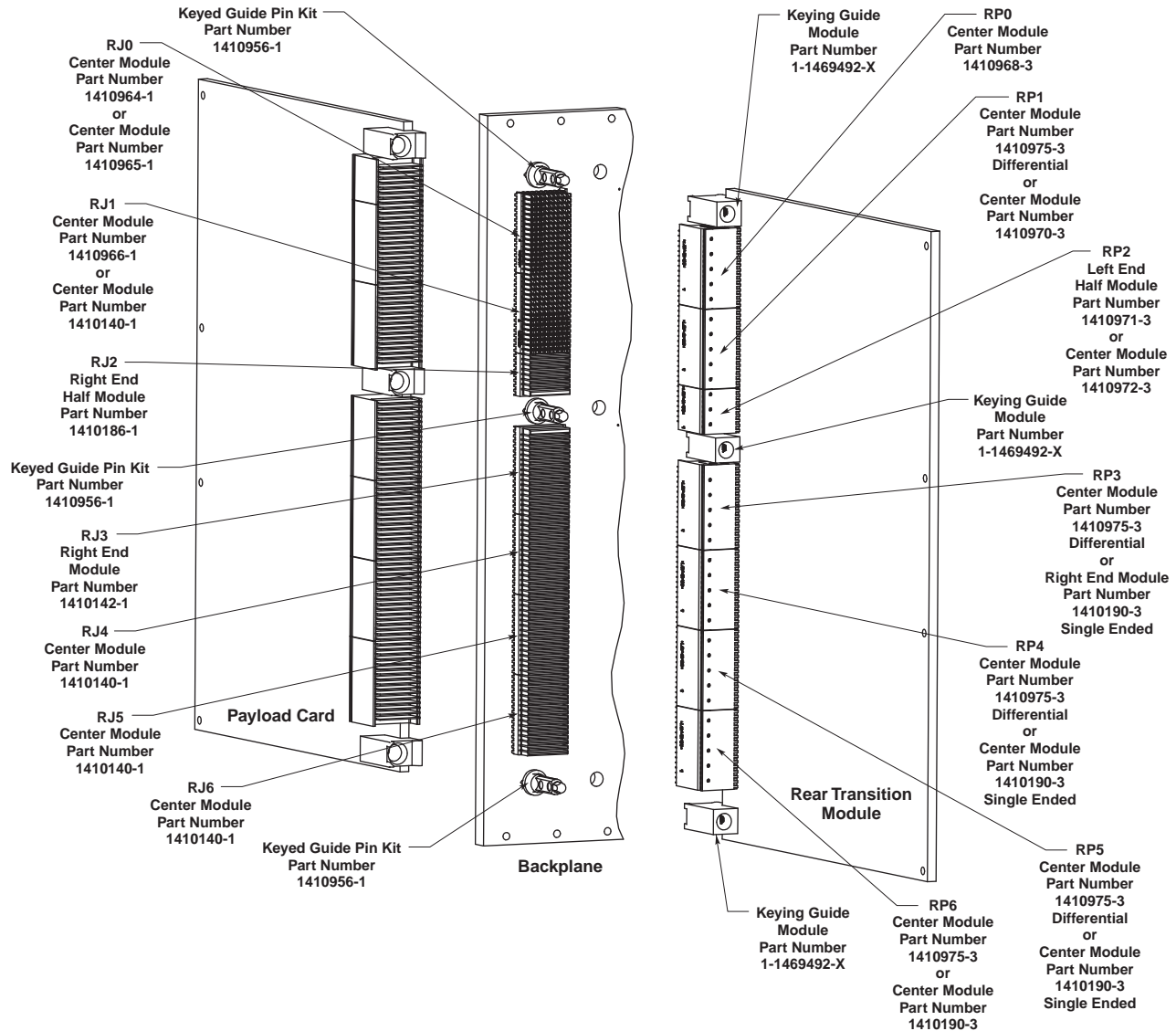

5 MULTIGIG RT Connector

VITA, VMEbus, VPX, and VXS are trademarks of VITA. Check out the website <http://www.vita.com/vso-stds.html>

Note: All part numbers are RoHS compliant.

“NEW” MULTIGIG RT Stacking Connector



Product Facts

- Variable Stack Height
25mm to 45mm+
- Interposer Part Numbers
 - 1410195-1 (Spaced for 30mm stack height)
 - 1410196-1 (Spaced for 30mm stack height)
 - 14101XX-1* (Spaced for any specification needed)
- Modular Construction
 - 0.8 inch (85 single ended lines/inch; 43 differential pairs/inch) (Available today)
 - 1.0 inch (113 single ended lines/inch; 56 differential pairs/inch)
- Wafer Configurations
 - Differential
 - Open Pin Field
 - Power
- Electrical performance based on MULTIGIG RT Tier 2 product construction (10 Gig performance)
- Compliant Pin Technology (Flat Rock Board Assembly)
- Qualified Interface
 - MULTIGIG RT Tier 2 product (Product Specification 108-2072)
 - Qualification Report 501-544

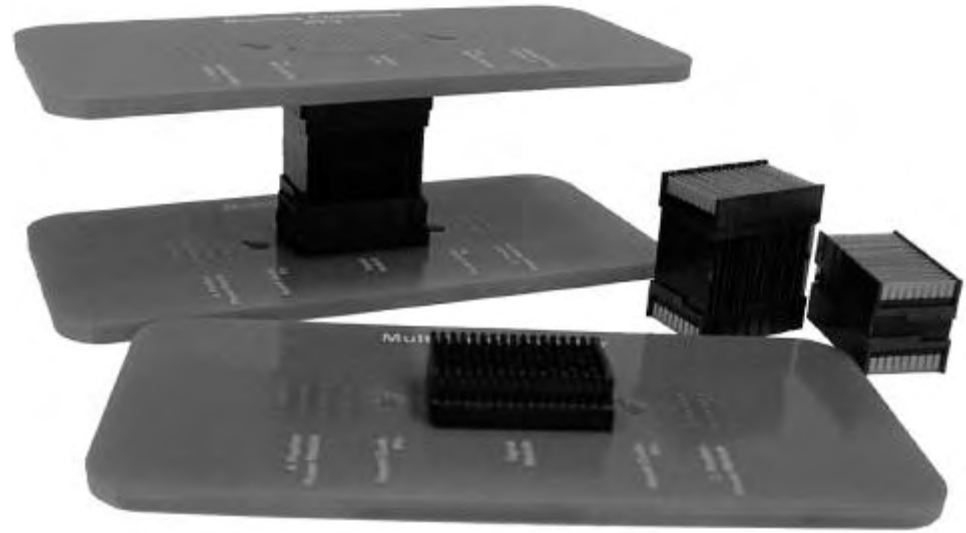

MULTIGIG RT Stacking Connectors are customizable to any stack heights needed.*

.8" Pitch — MULTIGIG RT Stacking Connector

Dimensions		Mated Stack Height	Part Number
A	B		
21.00 .827	20.00 .787	30.00 1.181	1410195-1
33.00 1.299	32.00 1.260	42.00 1.654	1410196-1

Mating 20.30 [.800] Pitch Receptacles found on page 148.

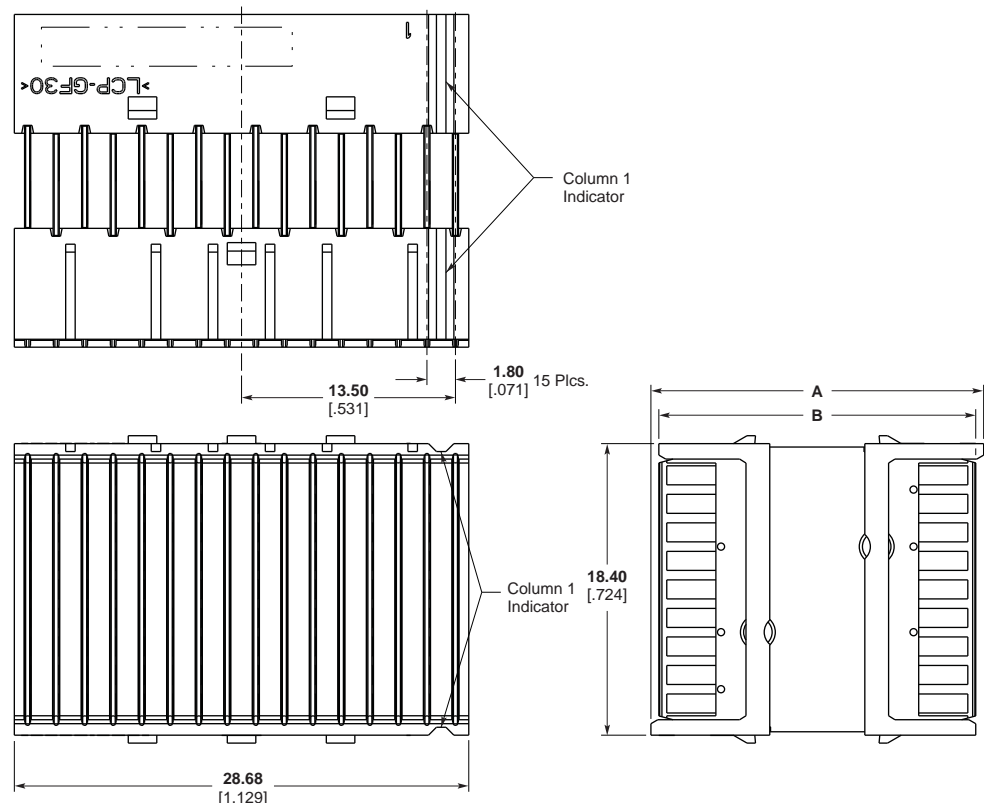

*Typically less than \$10,000 NRE and 6 weeks lead time

Note: All part numbers are RoHS compliant.

Power Modules and Guide Hardware Reference

Part Number 1410278-1

2-Position Vertical Receptacle

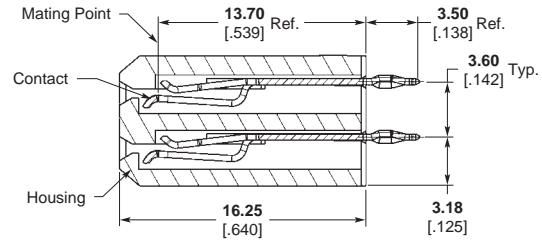
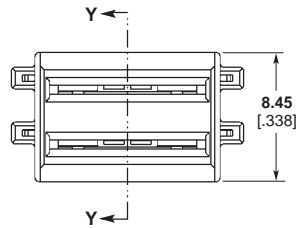

Section Y-Y

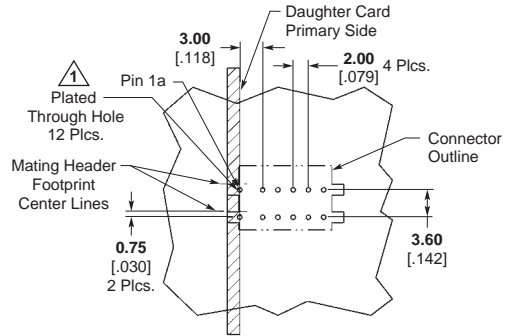
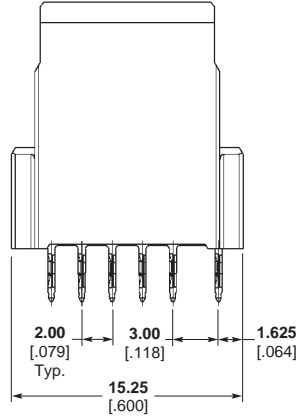

Recommended PCB Hole Layout

⚠ PCB Hole Dim.
 Drilled Hole = 0.70 ± 0.02 [0.28 ± .001]
 Finished Hole = 0.60 ± 0.05 [0.24 ± .002]
 Cu Thickness = $0.025 - 0.50$ [0.010 - .020]
 SnPb Thickness = 0.015 [0.0006] Max.

Part Number 1410270-1

4-Position Vertical Receptacle

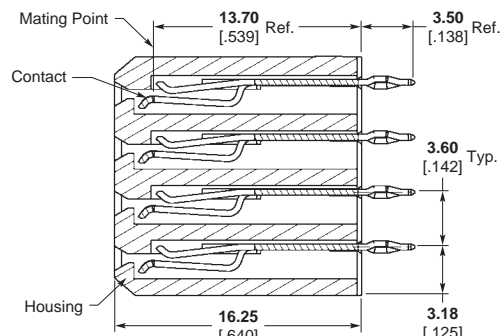
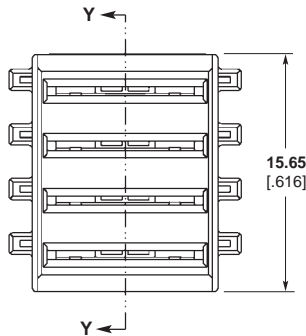

Section Y-Y

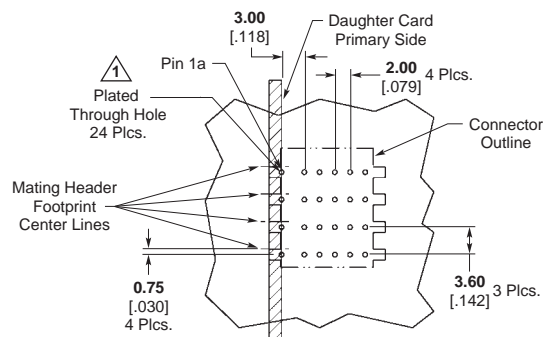
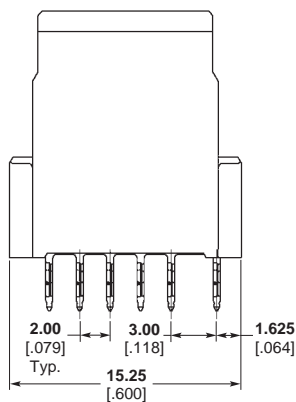

Recommended PCB Hole Layout

⚠ PCB Hole Dim.
 Drilled Hole = 0.70 ± 0.02 [0.28 ± .001]
 Finished Hole = 0.60 ± 0.05 [0.24 ± .002]
 Cu Thickness = $0.025 - 0.50$ [0.010 - .020]
 SnPb Thickness = 0.015 [0.0006] Max.

Note: All part numbers are RoHS compliant. Tin-Lead parts are RoHS compliant through exemption for lead in press-fit connectors.

Power Modules and Guide Hardware Reference (Continued)

Part Number 1410279-X

2-Position Right Angle Plug

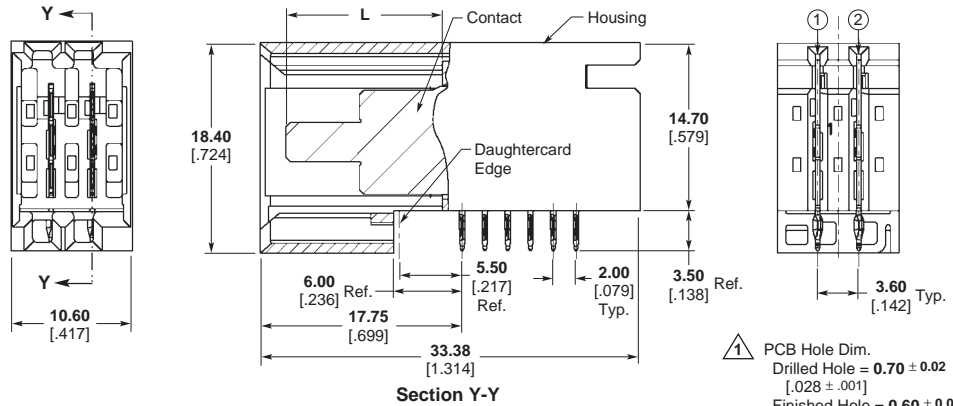

Dim. L		Part Number
Circuit 1	Circuit 2	
13.75 .541	13.75 .541	1410279-1
13.75 .541	12.25 .482	1410279-2
13.75 .541	10.75 .423	1410279-3
10.75 .423	10.75 .423	1410279-4
12.25 .482	10.75 .423	1410279-5
12.25 .482	12.25 .482	1410279-6

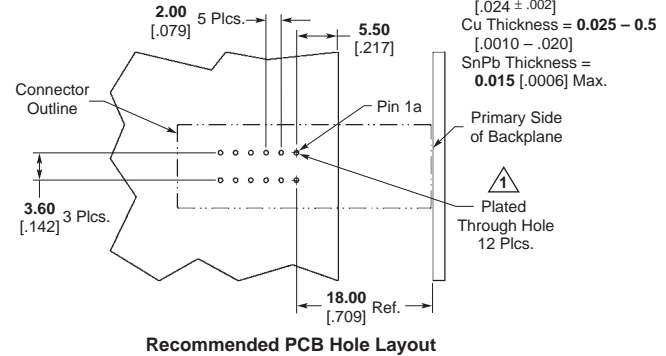

Part Number 1410271-X

4-Position Right Angle Plug

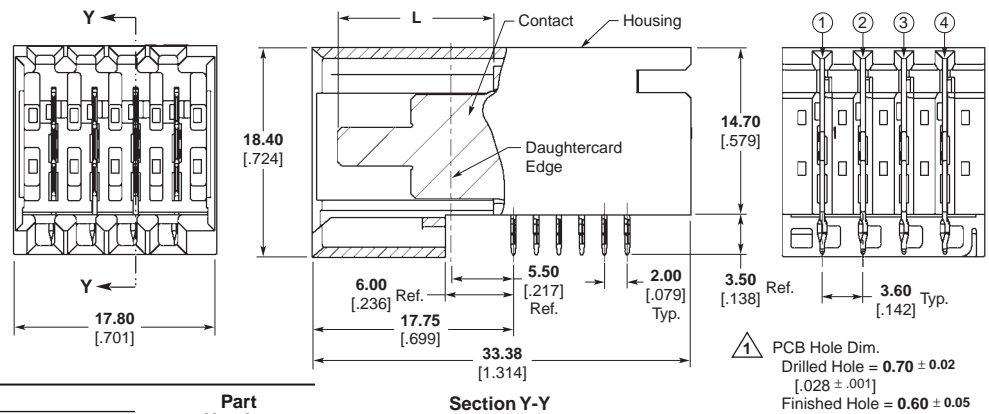

Dim. L				Part Number
Cavity 1	Cavity 2	Cavity 3	Cavity 4	
13.75 .541	13.75 .541	13.75 .541	13.75 .541	1410271-1
12.25 .482	13.75 .541	13.75 .541	12.25 .482	1410271-2
12.25 .482	13.75 .541	13.75 .541	10.75 .423	1410271-3
10.75 .423	13.75 .541	13.75 .541	10.75 .423	1410271-4
12.25 .482	13.75 .541	12.25 .482	10.75 .423	1410271-5
12.25 .482	12.25 .482	12.25 .482	12.25 .482	1410271-6
10.75 .423	12.25 .482	12.25 .482	10.75 .423	1410271-7
10.75 .423	10.75 .423	10.75 .423	10.75 .423	1410271-8
10.75 .423	13.75 .541	12.25 .482	10.75 .423	1410271-9
12.25 .482	10.75 .423	10.75 .541	12.25 .482	1-1410271-0

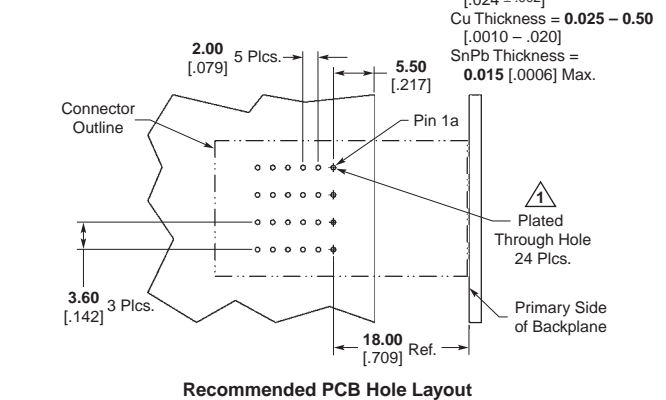

Note: All part numbers are RoHS compliant. Tin-Lead parts are RoHS compliant through exemption for lead in press-fit connectors.

Power Modules and Guide Hardware Reference (Continued)

7.2 mm Wide, No Key

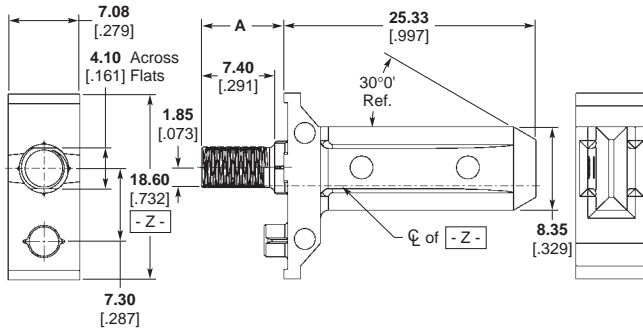

Pin Part Number 1-1410710-X

Dim. A	Part Number
8.72 .343	1-1410710-1
10.00 .394	1-1410710-2
11.60 .457	1-1410710-3
13.10 .516	1-1410710-4

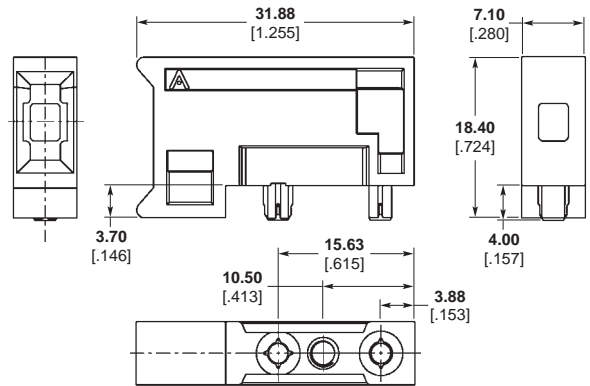

Guide Module Part Number 1410714-2

9.0 mm Wide, with Keying

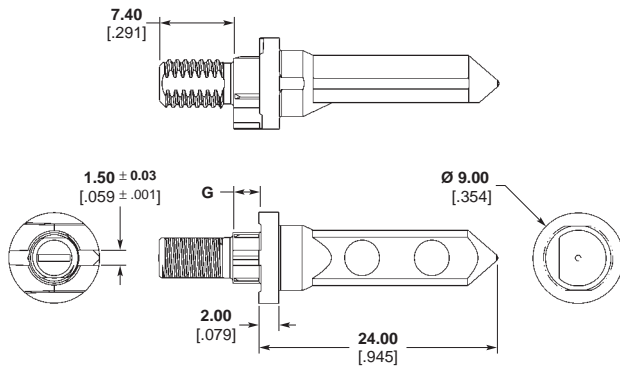

Pin Part Number 1-1469491-X

Dim. G	Part Number
2.60 .102	1-1469491-2
4.20 .165	1-1469491-3
5.70 .224	1-1469491-4

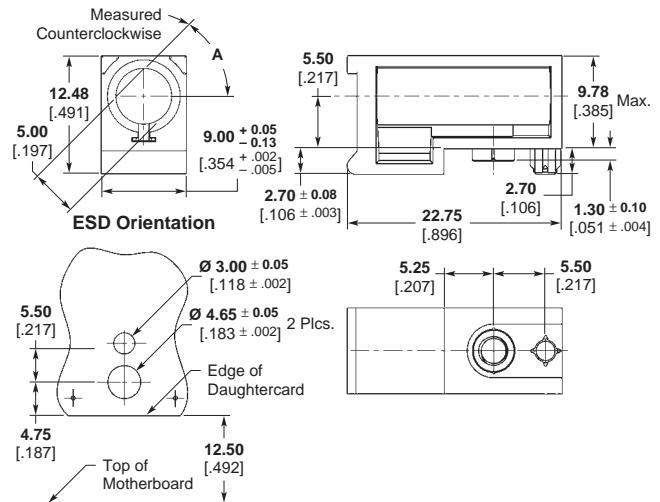

Guide Module Part Number 1-1469492-X

Dim. A	Part Number
0°	1-1469492-1
45°	1-1469492-2
90°	1-1469492-3
270°	1-1469492-7
315°	1-1469492-8
No Key	1-1469492-9

Mounting Screw for 9.0 mm Guide Modules Part Number 1410946-1 and 5.0 mm Guide Modules Part Number 1410946-2

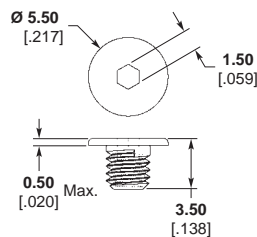

Note: All part numbers are RoHS compliant.

Power Modules and Guide Hardware Reference (Continued)

10.8 mm Wide, Guide Module, with Keying, with ESD Contact

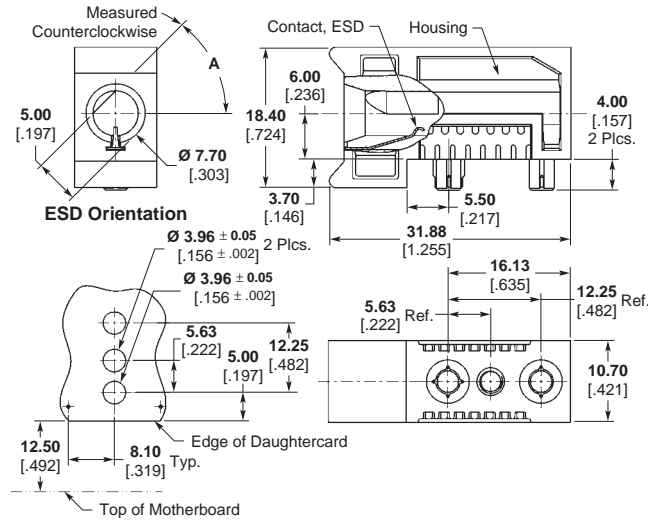

Dim. A	Part Number
0°	1-1410297-1
45°	1-1410297-2
90°	1-1410297-3
135°	1-1410297-4
180°	1-1410297-5
225°	1-1410297-6
270°	1-1410297-7
315°	1-1410297-8
No Key	1-1410297-9

Guide Module Part Number 1-1410297-X

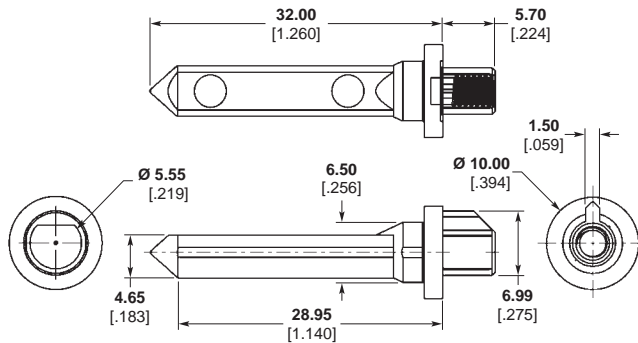

Pin Part Number 1410548-3

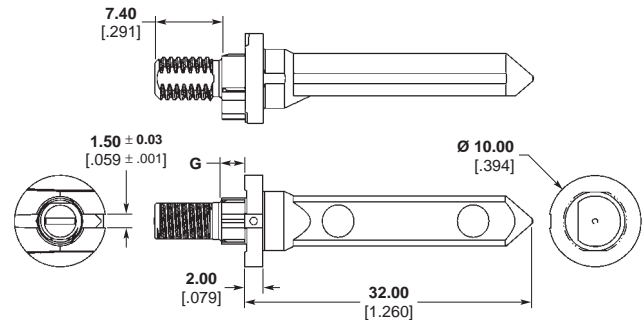

Pin Part Number 1-1410773-X

Dim. G	Part Number
2.60	1-1410773-2
.102	
4.20	1-1410773-3
.165	
5.70	1-1410773-4
.224	

Note: All part numbers are RoHS compliant.

Компания «Океан Электроники» предлагает заключение долгосрочных отношений при поставках импортных электронных компонентов на взаимовыгодных условиях!

Наши преимущества:

- Поставка оригинальных импортных электронных компонентов напрямую с производств Америки, Европы и Азии, а так же с крупнейших складов мира;
- Широкая линейка поставок активных и пассивных импортных электронных компонентов (более 30 млн. наименований);
- Поставка сложных, дефицитных, либо снятых с производства позиций;
- Оперативные сроки поставки под заказ (от 5 рабочих дней);
- Экспресс доставка в любую точку России;
- Помощь Конструкторского Отдела и консультации квалифицированных инженеров;
- Техническая поддержка проекта, помощь в подборе аналогов, поставка прототипов;
- Поставка электронных компонентов под контролем ВП;
- Система менеджмента качества сертифицирована по Международному стандарту ISO 9001;
- При необходимости вся продукция военного и аэрокосмического назначения проходит испытания и сертификацию в лаборатории (по согласованию с заказчиком);
- Поставка специализированных компонентов военного и аэрокосмического уровня качества (Xilinx, Altera, Analog Devices, Intersil, Interpoint, Microsemi, Actel, Aeroflex, Peregrine, VPT, Syfer, Eurofarad, Texas Instruments, MS Kennedy, Miteq, Cobham, E2V, MA-COM, Hittite, Mini-Circuits, General Dynamics и др.);

Компания «Океан Электроники» является официальным дистрибьютором и эксклюзивным представителем в России одного из крупнейших производителей разъемов военного и аэрокосмического назначения «JONHON», а так же официальным дистрибьютором и эксклюзивным представителем в России производителя высокотехнологичных и надежных решений для передачи СВЧ сигналов «FORSTAR».



JONHON

«JONHON» (основан в 1970 г.)

Разъемы специального, военного и аэрокосмического назначения:

(Применяются в военной, авиационной, аэрокосмической, морской, железнодорожной, горно- и нефтедобывающей отраслях промышленности)

«FORSTAR» (основан в 1998 г.)

ВЧ соединители, коаксиальные кабели,
кабельные сборки и микроволновые компоненты:

(Применяются в телекоммуникациях гражданского и специального назначения, в средствах связи, РЛС, а так же военной, авиационной и аэрокосмической отраслях промышленности).



Телефон: 8 (812) 309-75-97 (многоканальный)

Факс: 8 (812) 320-03-32

Электронная почта: ocean@oceanchips.ru

Web: <http://oceanchips.ru/>

Адрес: 198099, г. Санкт-Петербург, ул. Калинина, д. 2, корп. 4, лит. А