

TPSMC Series

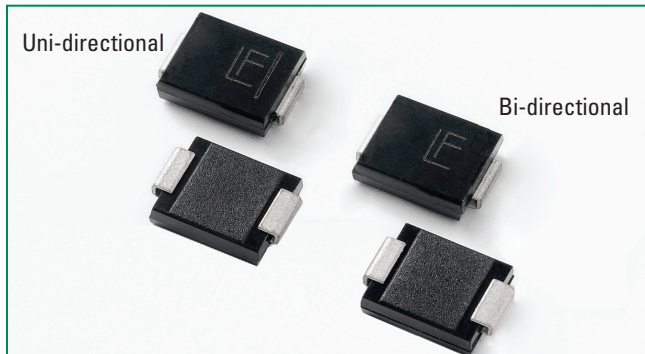

Agency Approvals

| AGENCY | AGENCY FILE NUMBER |
|--------|--------------------|
| | E230531 |

Maximum Ratings and Thermal Characteristics (T_A=25°C unless otherwise noted)

| Parameter | Symbol | Value | Unit |
|--|-----------------------------------|------------|------|
| Peak Pulse Power Dissipation at T _A =25°C by 10/1000µs Waveform (Fig.2)(Note 1), (Note 2) | P _{PPM} | 1500 | W |
| Power Dissipation on Infinite Heat Sink at T _A =50°C | P _{M(AV)} | 6.5 | W |
| Peak Forward Surge Current, 8.3ms Single Half Sine Wave (Note 3) | I _{FSM} | 200 | A |
| Maximum Instantaneous Forward Voltage at 100A for Unidirectional Only (Note 4) | V _F | 3.5/5.0 | V |
| Operating Junction and Storage Temperature Range | T _J , T _{STG} | -55 to 150 | °C |
| Typical Thermal Resistance Junction to Lead | R _{wJL} | 15 | °C/W |
| Typical Thermal Resistance Junction to Ambient | R _{wJA} | 75 | °C/W |

- Notes:**
1. Non-repetitive current pulse, per Fig. 4 and derated above T_A = 25°C per Fig. 3.
 2. Mounted on copper pad area of 0.31x0.31" (8.0 x 8.0mm) to each terminal.
 3. Measured on 8.3ms single half sine wave or equivalent square wave for unidirectional device only, duty cycle=4 per minute maximum.
 4. V_F<3.5V for V_{BR} ≤ 200V and V_F<5.0V for V_{BR} ≥ 201V.

Functional Diagram

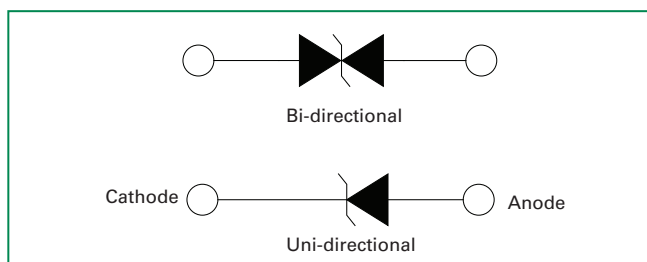

Description

The TPSMC series is designed specifically to protect sensitive electronic equipment from voltage transients induced by lightning and other transient voltage events.

Features

- Hi reliability application and automotive grade AEC Q101 qualified
- For surface mounted applications to optimize board space
- Low profile package.
- Typical failure mode is short from over-specified voltage or current
- Whisker test is conducted based on JEDEC JESD201A per its table 4a and 4c
- IEC-61000-4-2 ESD 15kV(Air), 8kV (Contact)
- ESD protection of data lines in accordance with IEC 61000-4-2 (IEC801-2)
- EFT protection of data lines in accordance with IEC 61000-4-4 (IEC801-4)
- Built-in strain relief
- V_{BR} @T_J = V_{BR} @25°C x (1 + αT x (T_J - 25)) (αT: Temperature Coefficient)
- Glass passivated chip junction
- 1500W peak pulse power capability at 10/1000µs waveform, repetition rate (duty cycles):0.01%
- Fast response time: typically less than 1.0ps from 0V to BV min
- Excellent clamping capability
- Low incremental surge resistance
- Typical I_R less than 1µA above 13V
- High temperature soldering guaranteed: 160°C/10 seconds at terminals
- Plastic package has underwriters laboratory flammability 94V-0
- Meet MSL level1, per J-STD-020, LF maximum peak of 260°C
- Matte tin lead-free plated
- Halogen free and RoHS compliant
- 2nd level interconnect is Pb-free per IPC/JEDEC J-STD-609A.01

Applications

TVS devices are ideal for the protection of I/O Interfaces, V_{CC} bus and other vulnerable circuits used in Telecom, Computer, Industrial and Consumer electronic applications.

Electrical Characteristics

| Part Number (Uni) | Part Number (Bi) | Marking | | Reverse Stand off Voltage V_R (Volts) | Breakdown Voltage V_{BR} (Volts) @ I_T | | Test Current I_T (mA) | Maximum Clamping Voltage V_C @ I_{pp} (V) | Maximum Peak Pulse Current I_{pp} (A) | Maximum Reverse Leakage I_R @ V_R (μ A) | Agency Approval  |
|-------------------|------------------|---------|------|---|--|-------|-------------------------|---|---|--|---|
| | | UNI | BI | | MIN | MAX | | | | | |
| TPSMC12A | TPSMC12CA | 12AA | 12CA | 10.20 | 11.40 | 12.60 | 1 | 16.7 | 91.0 | 5 | X |
| TPSMC13A | TPSMC13CA | 13AA | 13CA | 11.10 | 12.40 | 13.70 | 1 | 18.2 | 83.5 | 1 | X |
| TPSMC15A | TPSMC15CA | 15AA | 15CA | 12.80 | 14.30 | 15.80 | 1 | 21.2 | 71.7 | 1 | X |
| TPSMC16A | TPSMC16CA | 16AA | 16CA | 13.60 | 15.20 | 16.80 | 1 | 22.5 | 67.6 | 1 | X |
| TPSMC18A | TPSMC18CA | 18AA | 18CA | 15.30 | 17.10 | 18.90 | 1 | 25.2 | 60.3 | 1 | X |
| TPSMC20A | TPSMC20CA | 20AA | 20CA | 17.10 | 19.00 | 21.00 | 1 | 27.7 | 54.9 | 1 | X |
| TPSMC22A | TPSMC22CA | 22AA | 22CA | 18.80 | 20.90 | 23.10 | 1 | 30.6 | 49.7 | 1 | X |
| TPSMC24A | TPSMC24CA | 24AA | 24CA | 20.50 | 22.80 | 25.20 | 1 | 33.2 | 45.8 | 1 | X |
| TPSMC27A | TPSMC27CA | 27AA | 27CA | 23.10 | 25.70 | 28.40 | 1 | 37.5 | 40.5 | 1 | X |
| TPSMC30A | TPSMC30CA | 30AA | 30CA | 25.60 | 28.50 | 31.50 | 1 | 41.4 | 36.7 | 1 | X |
| TPSMC33A | TPSMC33CA | 33AA | 33CA | 28.20 | 31.40 | 34.70 | 1 | 45.7 | 33.3 | 1 | X |
| TPSMC36A | TPSMC36CA | 36AA | 36CA | 30.80 | 34.20 | 37.80 | 1 | 49.9 | 30.5 | 1 | X |
| TPSMC39A | TPSMC39CA | 39AA | 39CA | 33.30 | 37.10 | 41.00 | 1 | 53.9 | 28.2 | 1 | X |
| TPSMC43A | TPSMC43CA | 43AA | 43CA | 36.80 | 40.90 | 45.20 | 1 | 59.3 | 25.6 | 1 | X |
| TPSMC47A | TPSMC47CA | 47AA | 47CA | 40.20 | 44.70 | 49.40 | 1 | 64.8 | 23.5 | 1 | X |
| TPSMC51A | TPSMC51CA | 51AA | 51CA | 43.60 | 48.50 | 53.60 | 1 | 70.1 | 21.7 | 1 | X |
| TPSMC56A | TPSMC56CA | 56AA | 56CA | 47.80 | 53.20 | 58.80 | 1 | 77.0 | 19.7 | 1 | X |
| TPSMC62A | TPSMC62CA | 62AA | 62CA | 53.00 | 58.90 | 65.10 | 1 | 85.0 | 17.9 | 1 | X |
| TPSMC68A | TPSMC68CA | 68AA | 68CA | 58.10 | 64.60 | 71.40 | 1 | 92.0 | 16.5 | 1 | X |
| TPSMC75A | TPSMC75CA | 75AA | 75CA | 64.10 | 71.30 | 78.80 | 1 | 103.0 | 14.8 | 1 | X |
| TPSMC82A | TPSMC82CA | 82AA | 82CA | 70.10 | 77.90 | 86.10 | 1 | 113.0 | 13.5 | 1 | X |
| TPSMC91A | TPSMC91CA | 91AA | 91CA | 77.80 | 86.50 | 95.50 | 1 | 125.0 | 12.2 | 1 | X |

For bidirectional type having V_R of 10 volts and less, the I_R limit is double.

For parts without A, the V_{BR} is $\pm 10\%$ and V_C is 5% higher than with A parts.

I-V Curve Characteristics

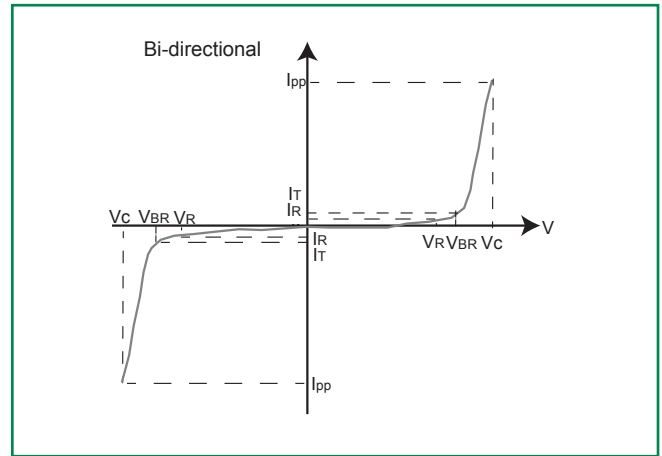
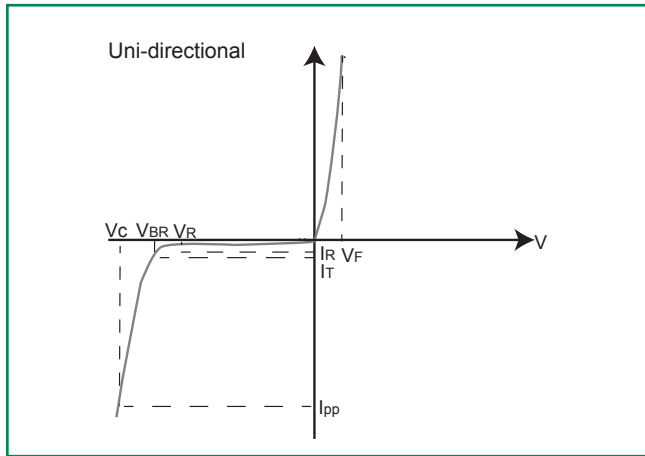

P_{PPM} Peak Pulse Power Dissipation – Max power dissipation

V_R Stand-off Voltage – Maximum voltage that can be applied to the TVS without operation

V_{BR} Breakdown Voltage – Maximum voltage that flows through the TVS at a specified test current (I_T)

V_C Clamping Voltage – Peak voltage measured across the suppressor at a specified I_{ppm} (peak impulse current)

I_R Reverse Leakage Current – Current measured at V_R

V_F Forward Voltage Drop for Uni-directional

Ratings and Characteristic Curves (T_A=25°C unless otherwise noted)

Figure 1 - TVS Transients Clamping Waveform

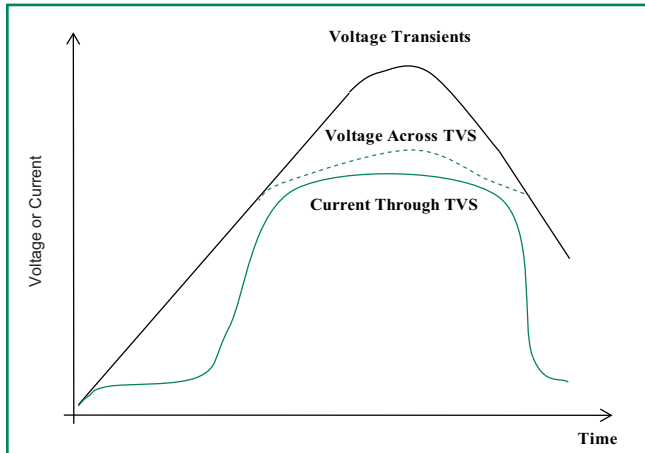
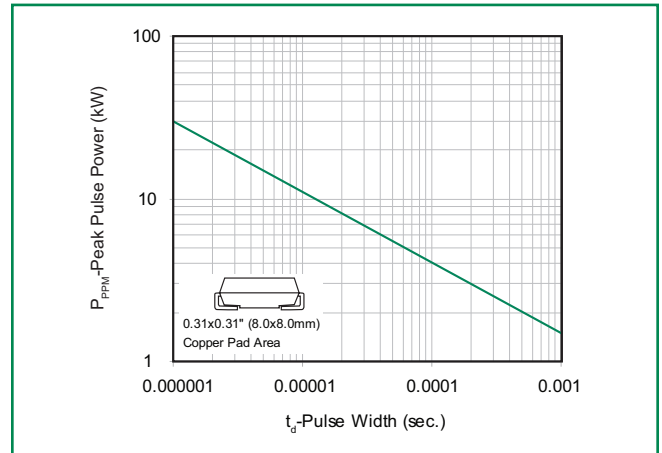

Figure 2 - Peak Pulse Power Rating



continues on next page.

Ratings and Characteristic Curves ($T_A=25^\circ\text{C}$ unless otherwise noted) (Continued)

Figure 3 - Pulse Derating Curve

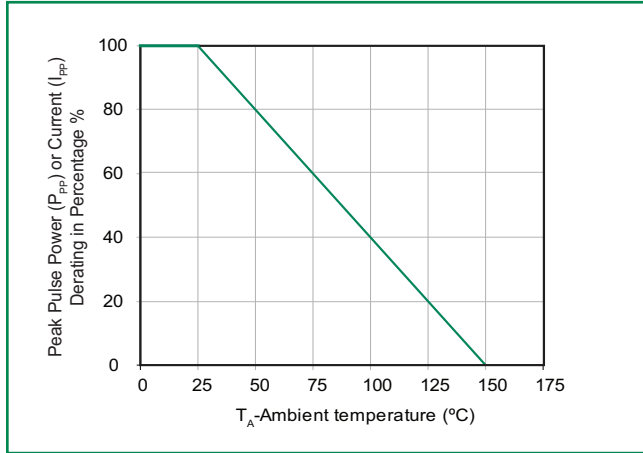

Figure 4 - Pulse Waveform

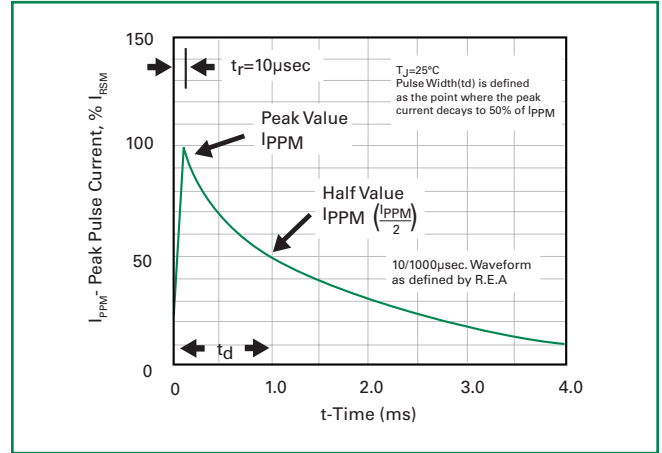

Figure 5 - Typical Junction Capacitance

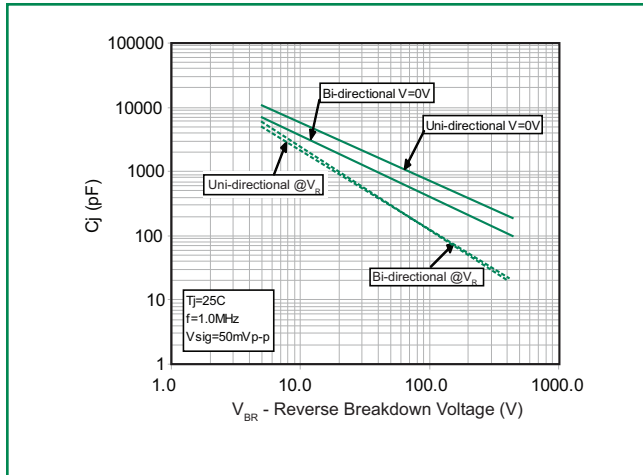

Figure 6 - Steady State Power Dissipation Derating Curve

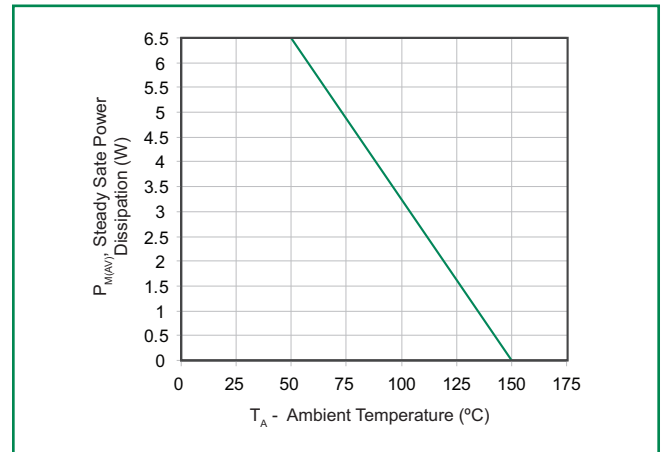
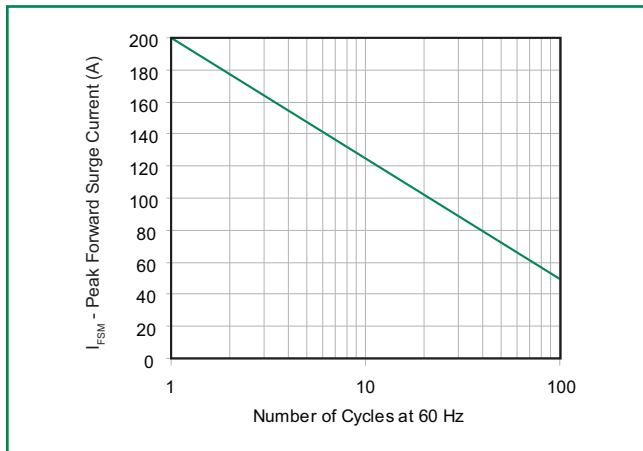
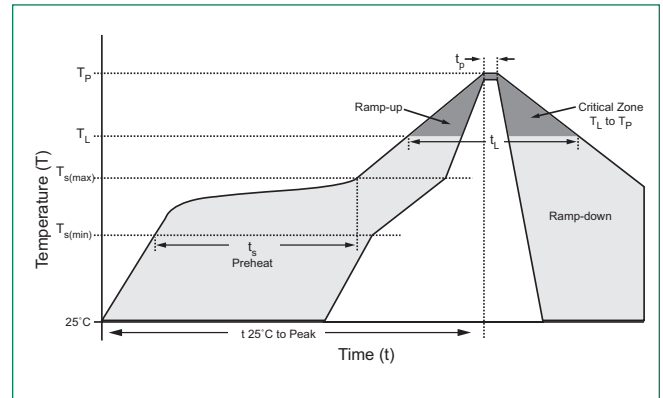

Figure 7 - Maximum Non-Repetitive Peak Forward Surge Current Uni-Directional Only



Soldering Parameters

| | | |
|--|------------------------------------|-------------------------|
| Reflow Condition | | Lead-free assembly |
| Pre Heat | - Temperature Min ($T_{s(min)}$) | 150°C |
| | - Temperature Max ($T_{s(max)}$) | 200°C |
| | - Time (min to max) (t_s) | 60 – 120 secs |
| Average ramp up rate (Liquidus Temp (T_L) to peak) | | 3°C/second max |
| $T_{s(max)}$ to T_L - Ramp-up Rate | | 3°C/second max |
| Reflow | - Temperature (T_L) (Liquidus) | 217°C |
| | - Time (min to max) (t_s) | 60 – 150 seconds |
| Peak Temperature (T_p) | | 260 ^{+0/-5} °C |
| Time within 5°C of actual peak Temperature (t_p) | | 30 seconds max |
| Ramp-down Rate | | 6°C/second max |
| Time 25°C to peak Temperature (T_p) | | 8 minutes max. |
| Do not exceed | | 280°C |



Physical Specifications

| | |
|-----------------|---|
| Weight | 0.007 ounce, 0.21 grams |
| Case | JEDEC DO214AB. Molded plastic body over glass passivated junction |
| Polarity | Color band denotes positive end (cathode) except Bidirectional. |
| Terminal | Matte Tin-plated leads, Solderable per JESD22-B102 |

Environmental Specifications

| | |
|----------------------------|--------------------------|
| High Temp. Storage | JESD22-A103 |
| HTRB | JESD22-A108 |
| Temperature Cycling | JESD22-A104 |
| MSL | JEDEC-J-STD-020, Level 1 |
| H3TRB | JESD22-A101 |
| RSH | JESD22-B106 |

Dimensions

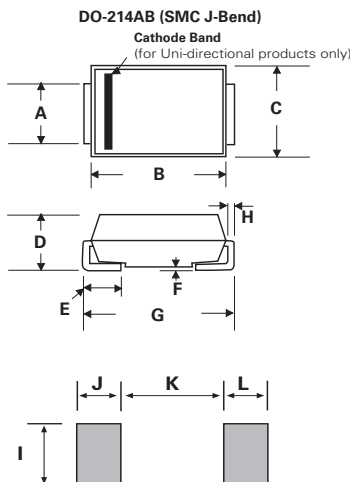

| Dimensions | Inches | | Millimeters | |
|------------|--------|-------|-------------|-------|
| | Min | Max | Min | Max |
| A | 0.114 | 0.126 | 2.900 | 3.200 |
| B | 0.260 | 0.280 | 6.600 | 7.110 |
| C | 0.220 | 0.245 | 5.590 | 6.220 |
| D | 0.079 | 0.103 | 2.060 | 2.620 |
| E | 0.030 | 0.060 | 0.760 | 1.520 |
| F | - | 0.008 | - | 0.203 |
| G | 0.305 | 0.320 | 7.750 | 8.130 |
| H | 0.006 | 0.012 | 0.152 | 0.305 |
| I | 0.129 | - | 3.300 | - |
| J | 0.094 | - | 2.400 | - |
| K | - | 0.165 | - | 4.200 |
| L | 0.094 | - | 2.400 | - |

Part Numbering System

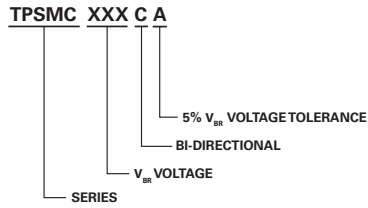

Part Marking System

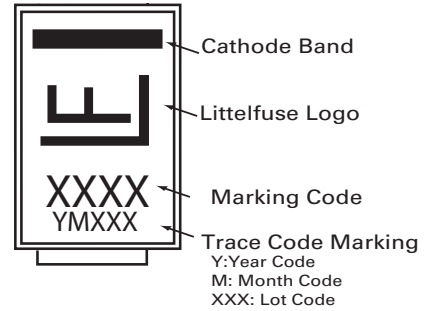

Packaging

| Part number | Component Package | Quantity | Packaging Option | Packaging Specification |
|-------------|-------------------|----------|----------------------------------|-------------------------|
| TPSMCxxxXX | DO-214AB | 3000 | Tape & Reel - 16mm tape/13" reel | EIA STD RS-481 |

Tape and Reel Specification

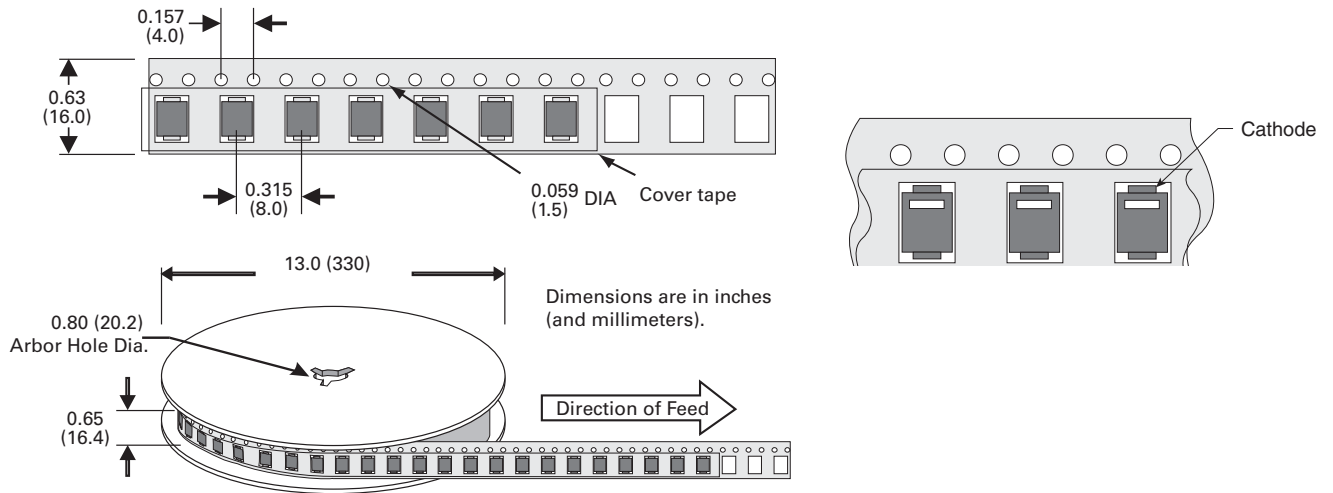

Компания «Океан Электроники» предлагает заключение долгосрочных отношений при поставках импортных электронных компонентов на взаимовыгодных условиях!

Наши преимущества:

- Поставка оригинальных импортных электронных компонентов напрямую с производств Америки, Европы и Азии, а так же с крупнейших складов мира;
- Широкая линейка поставок активных и пассивных импортных электронных компонентов (более 30 млн. наименований);
- Поставка сложных, дефицитных, либо снятых с производства позиций;
- Оперативные сроки поставки под заказ (от 5 рабочих дней);
- Экспресс доставка в любую точку России;
- Помощь Конструкторского Отдела и консультации квалифицированных инженеров;
- Техническая поддержка проекта, помощь в подборе аналогов, поставка прототипов;
- Поставка электронных компонентов под контролем ВП;
- Система менеджмента качества сертифицирована по Международному стандарту ISO 9001;
- При необходимости вся продукция военного и аэрокосмического назначения проходит испытания и сертификацию в лаборатории (по согласованию с заказчиком);
- Поставка специализированных компонентов военного и аэрокосмического уровня качества (Xilinx, Altera, Analog Devices, Intersil, Interpoint, Microsemi, Actel, Aeroflex, Peregrine, VPT, Syfer, Eurofarad, Texas Instruments, MS Kennedy, Miteq, Cobham, E2V, MA-COM, Hittite, Mini-Circuits, General Dynamics и др.);

Компания «Океан Электроники» является официальным дистрибьютором и эксклюзивным представителем в России одного из крупнейших производителей разъемов военного и аэрокосмического назначения «JONHON», а так же официальным дистрибьютором и эксклюзивным представителем в России производителя высокотехнологичных и надежных решений для передачи СВЧ сигналов «FORSTAR».



JONHON

«JONHON» (основан в 1970 г.)

Разъемы специального, военного и аэрокосмического назначения:

(Применяются в военной, авиационной, аэрокосмической, морской, железнодорожной, горно- и нефтедобывающей отраслях промышленности)

«FORSTAR» (основан в 1998 г.)

ВЧ соединители, коаксиальные кабели, кабельные сборки и микроволновые компоненты:

(Применяются в телекоммуникациях гражданского и специального назначения, в средствах связи, РЛС, а так же военной, авиационной и аэрокосмической отраслях промышленности).



Телефон: 8 (812) 309-75-97 (многоканальный)

Факс: 8 (812) 320-03-32

Электронная почта: ocean@oceanchips.ru

Web: <http://oceanchips.ru/>

Адрес: 198099, г. Санкт-Петербург, ул. Калинина, д. 2, корп. 4, лит. А