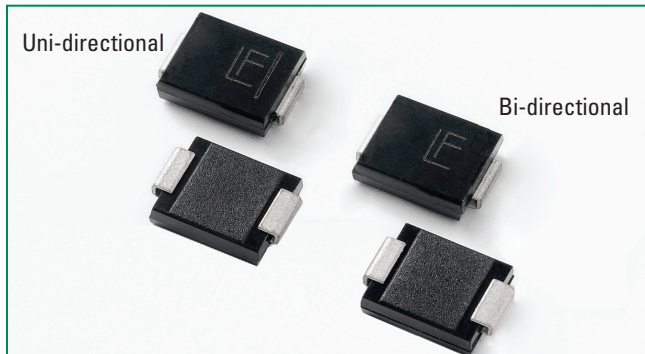


**TPSMC Series**



**Agency Approvals**

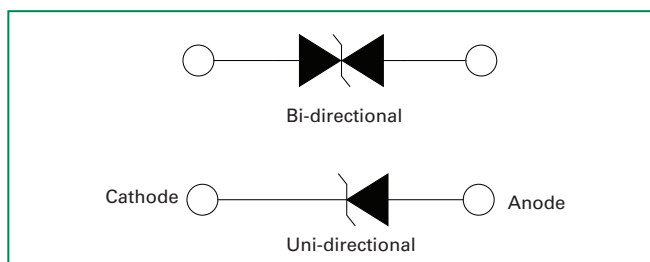
AGENCY	AGENCY FILE NUMBER
	E230531

**Maximum Ratings and Thermal Characteristics (T<sub>A</sub>=25°C unless otherwise noted)**

Parameter	Symbol	Value	Unit
Peak Pulse Power Dissipation at T <sub>A</sub> =25°C by 10/1000µs Waveform (Fig.2)(Note 1), (Note 2)	P <sub>PPM</sub>	1500	W
Power Dissipation on Infinite Heat Sink at T <sub>A</sub> =50°C	P <sub>M(AV)</sub>	6.5	W
Peak Forward Surge Current, 8.3ms Single Half Sine Wave (Note 3)	I <sub>FSM</sub>	200	A
Maximum Instantaneous Forward Voltage at 100A for Unidirectional Only (Note 4)	V <sub>F</sub>	3.5/5.0	V
Operating Junction and Storage Temperature Range	T <sub>J</sub> , T <sub>STG</sub>	-55 to 150	°C
Typical Thermal Resistance Junction to Lead	R <sub>wJL</sub>	15	°C/W
Typical Thermal Resistance Junction to Ambient	R <sub>wJA</sub>	75	°C/W

- Notes:**
1. Non-repetitive current pulse, per Fig. 4 and derated above T<sub>A</sub> = 25°C per Fig. 3.
  2. Mounted on copper pad area of 0.31x0.31" (8.0 x 8.0mm) to each terminal.
  3. Measured on 8.3ms single half sine wave or equivalent square wave for unidirectional device only, duty cycle=4 per minute maximum.
  4. V<sub>F</sub><3.5V for V<sub>BR</sub> ≤ 200V and V<sub>F</sub><5.0V for V<sub>BR</sub> ≥ 201V.

**Functional Diagram**



**Description**

The TPSMC series is designed specifically to protect sensitive electronic equipment from voltage transients induced by lightning and other transient voltage events.


**Features**

- Hi reliability application and automotive grade AEC Q101 qualified
- For surface mounted applications to optimize board space
- Low profile package.
- Typical failure mode is short from over-specified voltage or current
- Whisker test is conducted based on JEDEC JESD201A per its table 4a and 4c
- IEC-61000-4-2 ESD 15kV(Air), 8kV (Contact)
- ESD protection of data lines in accordance with IEC 61000-4-2 (IEC801-2)
- EFT protection of data lines in accordance with IEC 61000-4-4 (IEC801-4)
- Built-in strain relief
- V<sub>BR</sub> @T<sub>J</sub> = V<sub>BR</sub> @25°C x (1 + α T x (T<sub>J</sub> - 25)) (α T: Temperature Coefficient)
- Glass passivated chip junction
- 1500W peak pulse power capability at 10/1000µs waveform, repetition rate (duty cycles):0.01%
- Fast response time: typically less than 1.0ps from 0V to BV min
- Excellent clamping capability
- Low incremental surge resistance
- Typical I<sub>R</sub> less than 1µA above 13V
- High temperature soldering guaranteed: 160°C/10 seconds at terminals
- Plastic package has underwriters laboratory flammability 94V-0
- Meet MSL level1, per J-STD-020, LF maximum peak of 260°C
- Matte tin lead-free plated
- Halogen free and RoHS compliant
- 2nd level interconnect is Pb-free per IPC/JEDEC J-STD-609A.01

**Applications**

TVS devices are ideal for the protection of I/O Interfaces, V<sub>CC</sub> bus and other vulnerable circuits used in Telecom, Computer, Industrial and Consumer electronic applications.

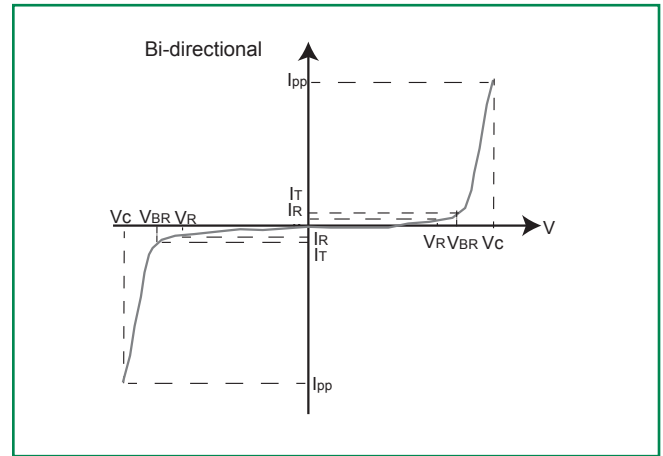
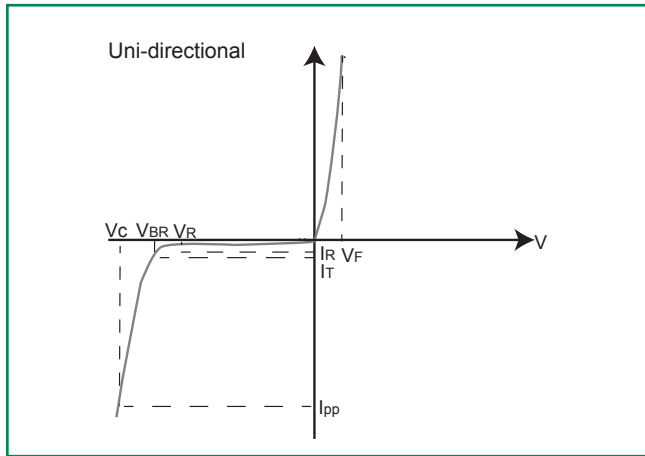
### Electrical Characteristics

Part Number (Uni)	Part Number (Bi)	Marking		Reverse Stand off Voltage $V_R$ (Volts)	Breakdown Voltage $V_{BR}$ (Volts) @ $I_T$		Test Current $I_T$ (mA)	Maximum Clamping Voltage $V_C$ @ $I_{pp}$ (V)	Maximum Peak Pulse Current $I_{pp}$ (A)	Maximum Reverse Leakage $I_R$ @ $V_R$ ( $\mu$ A)	Agency Approval 
		UNI	BI		MIN	MAX					
TPSMC12A	TPSMC12CA	12AA	12CA	10.20	11.40	12.60	1	16.7	91.0	5	X
TPSMC13A	TPSMC13CA	13AA	13CA	11.10	12.40	13.70	1	18.2	83.5	1	X
TPSMC15A	TPSMC15CA	15AA	15CA	12.80	14.30	15.80	1	21.2	71.7	1	X
TPSMC16A	TPSMC16CA	16AA	16CA	13.60	15.20	16.80	1	22.5	67.6	1	X
TPSMC18A	TPSMC18CA	18AA	18CA	15.30	17.10	18.90	1	25.2	60.3	1	X
TPSMC20A	TPSMC20CA	20AA	20CA	17.10	19.00	21.00	1	27.7	54.9	1	X
TPSMC22A	TPSMC22CA	22AA	22CA	18.80	20.90	23.10	1	30.6	49.7	1	X
TPSMC24A	TPSMC24CA	24AA	24CA	20.50	22.80	25.20	1	33.2	45.8	1	X
TPSMC27A	TPSMC27CA	27AA	27CA	23.10	25.70	28.40	1	37.5	40.5	1	X
TPSMC30A	TPSMC30CA	30AA	30CA	25.60	28.50	31.50	1	41.4	36.7	1	X
TPSMC33A	TPSMC33CA	33AA	33CA	28.20	31.40	34.70	1	45.7	33.3	1	X
TPSMC36A	TPSMC36CA	36AA	36CA	30.80	34.20	37.80	1	49.9	30.5	1	X
TPSMC39A	TPSMC39CA	39AA	39CA	33.30	37.10	41.00	1	53.9	28.2	1	X
TPSMC43A	TPSMC43CA	43AA	43CA	36.80	40.90	45.20	1	59.3	25.6	1	X
TPSMC47A	TPSMC47CA	47AA	47CA	40.20	44.70	49.40	1	64.8	23.5	1	X
TPSMC51A	TPSMC51CA	51AA	51CA	43.60	48.50	53.60	1	70.1	21.7	1	X
TPSMC56A	TPSMC56CA	56AA	56CA	47.80	53.20	58.80	1	77.0	19.7	1	X
TPSMC62A	TPSMC62CA	62AA	62CA	53.00	58.90	65.10	1	85.0	17.9	1	X
TPSMC68A	TPSMC68CA	68AA	68CA	58.10	64.60	71.40	1	92.0	16.5	1	X
TPSMC75A	TPSMC75CA	75AA	75CA	64.10	71.30	78.80	1	103.0	14.8	1	X
TPSMC82A	TPSMC82CA	82AA	82CA	70.10	77.90	86.10	1	113.0	13.5	1	X
TPSMC91A	TPSMC91CA	91AA	91CA	77.80	86.50	95.50	1	125.0	12.2	1	X

For bidirectional type having  $V_R$  of 10 volts and less, the  $I_R$  limit is double.

For parts without A, the  $V_{BR}$  is  $\pm 10\%$  and  $V_C$  is 5% higher than with A parts.

**I-V Curve Characteristics**



**P<sub>PPM</sub> Peak Pulse Power Dissipation** – Max power dissipation

**V<sub>R</sub> Stand-off Voltage** – Maximum voltage that can be applied to the TVS without operation

**V<sub>BR</sub> Breakdown Voltage** – Maximum voltage that flows through the TVS at a specified test current (I<sub>T</sub>)

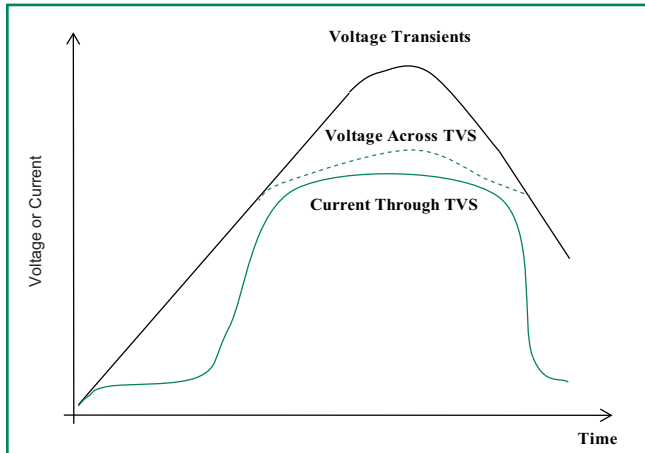
**V<sub>C</sub> Clamping Voltage** – Peak voltage measured across the suppressor at a specified I<sub>ppm</sub> (peak impulse current)

**I<sub>R</sub> Reverse Leakage Current** – Current measured at V<sub>R</sub>

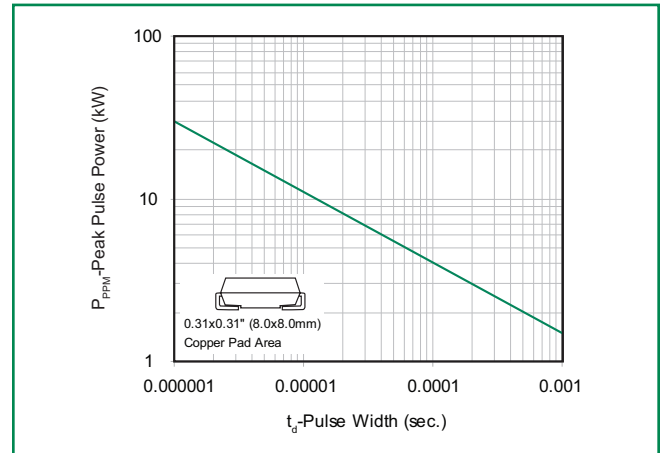
**V<sub>F</sub> Forward Voltage Drop for Uni-directional**

**Ratings and Characteristic Curves (T<sub>A</sub>=25°C unless otherwise noted)**

**Figure 1 - TVS Transients Clamping Waveform**



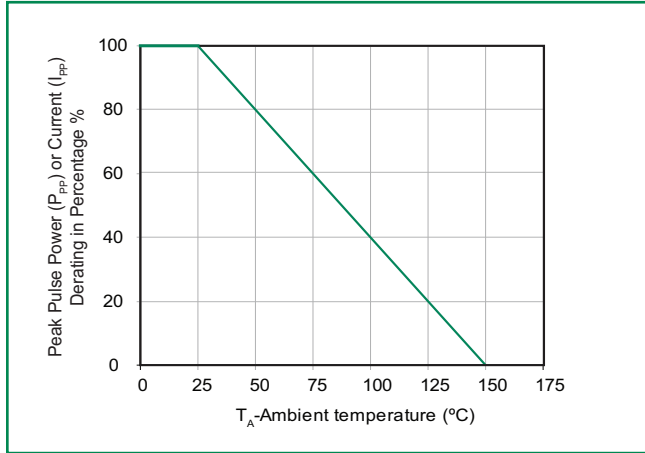
**Figure 2 - Peak Pulse Power Rating**



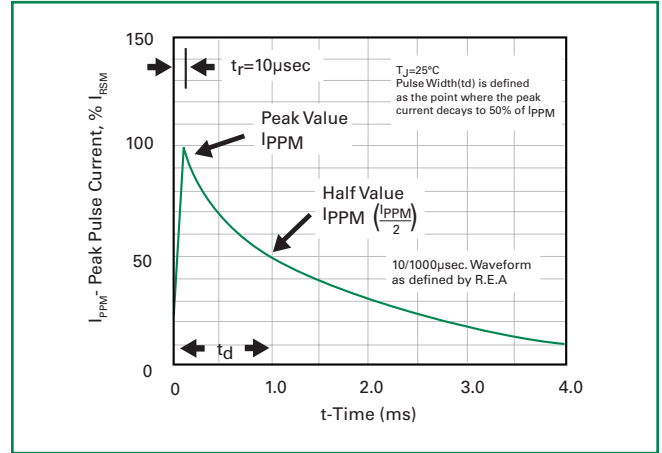
continues on next page.

**Ratings and Characteristic Curves** ( $T_A=25^\circ\text{C}$  unless otherwise noted) (Continued)

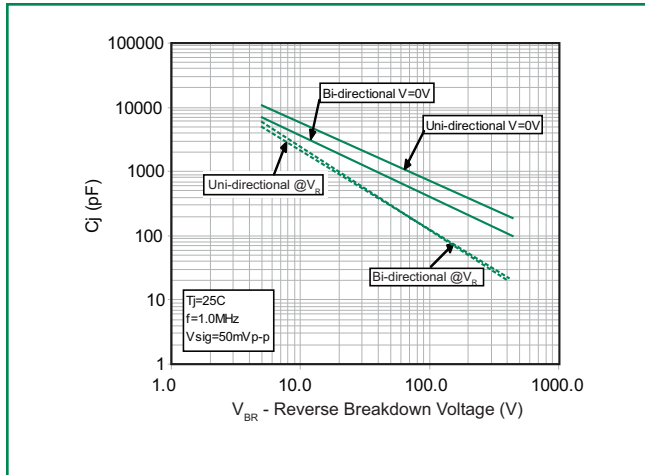
**Figure 3 - Pulse Derating Curve**



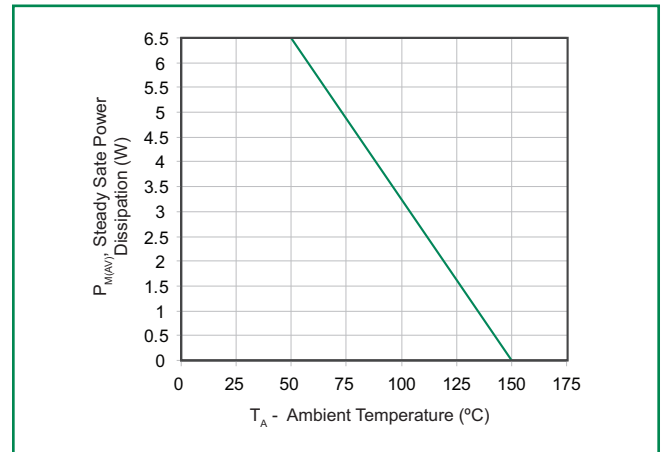
**Figure 4 - Pulse Waveform**



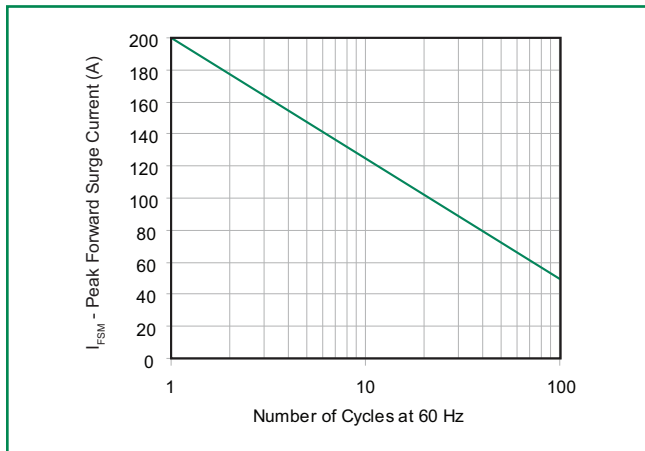
**Figure 5 - Typical Junction Capacitance**



**Figure 6 - Steady State Power Dissipation Derating Curve**

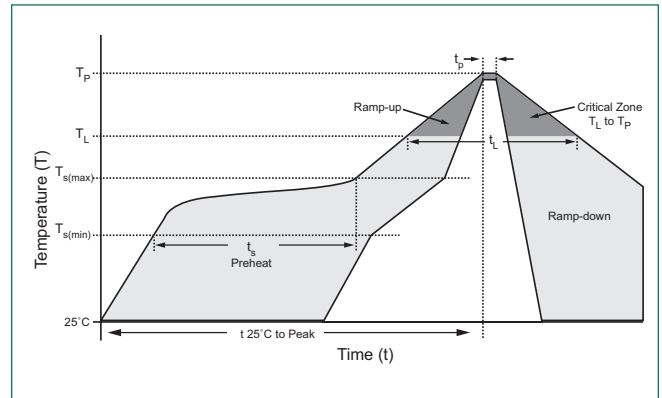


**Figure 7 - Maximum Non-Repetitive Peak Forward Surge Current Uni-Directional Only**



**Soldering Parameters**

Reflow Condition		Lead-free assembly
Pre Heat	- Temperature Min ( $T_{s(min)}$ )	150°C
	- Temperature Max ( $T_{s(max)}$ )	200°C
	- Time (min to max) ( $t_s$ )	60 – 120 secs
Average ramp up rate (Liquidus Temp ( $T_L$ ) to peak)		3°C/second max
$T_{s(max)}$ to $T_L$ - Ramp-up Rate		3°C/second max
Reflow	- Temperature ( $T_L$ ) (Liquidus)	217°C
	- Time (min to max) ( $t_s$ )	60 – 150 seconds
Peak Temperature ( $T_p$ )		260 <sup>+0/-5</sup> °C
Time within 5°C of actual peak Temperature ( $t_p$ )		30 seconds max
Ramp-down Rate		6°C/second max
Time 25°C to peak Temperature ( $T_p$ )		8 minutes max.
Do not exceed		280°C



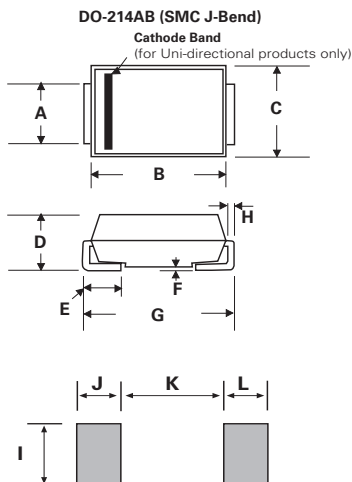
**Physical Specifications**

<b>Weight</b>	0.007 ounce, 0.21 grams
<b>Case</b>	JEDEC DO214AB. Molded plastic body over glass passivated junction
<b>Polarity</b>	Color band denotes positive end (cathode) except Bidirectional.
<b>Terminal</b>	Matte Tin-plated leads, Solderable per JESD22-B102

**Environmental Specifications**

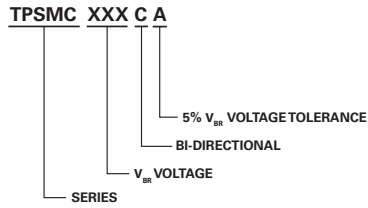
<b>High Temp. Storage</b>	JESD22-A103
<b>HTRB</b>	JESD22-A108
<b>Temperature Cycling</b>	JESD22-A104
<b>MSL</b>	JEDEC-J-STD-020, Level 1
<b>H3TRB</b>	JESD22-A101
<b>RSH</b>	JESD22-B106

**Dimensions**

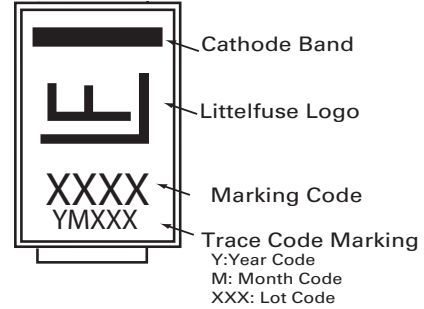


Dimensions	Inches		Millimeters	
	Min	Max	Min	Max
A	0.114	0.126	2.900	3.200
B	0.260	0.280	6.600	7.110
C	0.220	0.245	5.590	6.220
D	0.079	0.103	2.060	2.620
E	0.030	0.060	0.760	1.520
F	-	0.008	-	0.203
G	0.305	0.320	7.750	8.130
H	0.006	0.012	0.152	0.305
I	0.129	-	3.300	-
J	0.094	-	2.400	-
K	-	0.165	-	4.200
L	0.094	-	2.400	-

### Part Numbering System



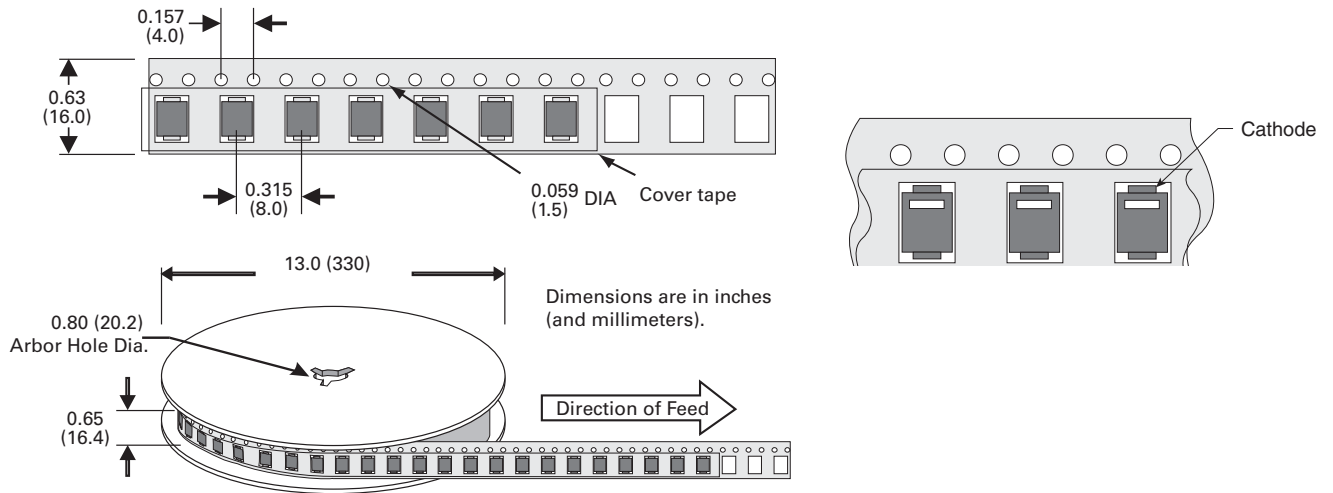
### Part Marking System



### Packaging

Part number	Component Package	Quantity	Packaging Option	Packaging Specification
TPSMCxxxXX	DO-214AB	3000	Tape & Reel - 16mm tape/13" reel	EIA STD RS-481

### Tape and Reel Specification



Компания «Океан Электроники» предлагает заключение долгосрочных отношений при поставках импортных электронных компонентов на взаимовыгодных условиях!

Наши преимущества:

- Поставка оригинальных импортных электронных компонентов напрямую с производств Америки, Европы и Азии, а так же с крупнейших складов мира;
- Широкая линейка поставок активных и пассивных импортных электронных компонентов (более 30 млн. наименований);
- Поставка сложных, дефицитных, либо снятых с производства позиций;
- Оперативные сроки поставки под заказ (от 5 рабочих дней);
- Экспресс доставка в любую точку России;
- Помощь Конструкторского Отдела и консультации квалифицированных инженеров;
- Техническая поддержка проекта, помощь в подборе аналогов, поставка прототипов;
- Поставка электронных компонентов под контролем ВП;
- Система менеджмента качества сертифицирована по Международному стандарту ISO 9001;
- При необходимости вся продукция военного и аэрокосмического назначения проходит испытания и сертификацию в лаборатории (по согласованию с заказчиком);
- Поставка специализированных компонентов военного и аэрокосмического уровня качества (Xilinx, Altera, Analog Devices, Intersil, Interpoint, Microsemi, Actel, Aeroflex, Peregrine, VPT, Syfer, Eurofarad, Texas Instruments, MS Kennedy, Miteq, Cobham, E2V, MA-COM, Hittite, Mini-Circuits, General Dynamics и др.);

Компания «Океан Электроники» является официальным дистрибьютором и эксклюзивным представителем в России одного из крупнейших производителей разъемов военного и аэрокосмического назначения «**JONHON**», а так же официальным дистрибьютором и эксклюзивным представителем в России производителя высокотехнологичных и надежных решений для передачи СВЧ сигналов «**FORSTAR**».



## JONHON

«**JONHON**» (основан в 1970 г.)

Разъемы специального, военного и аэрокосмического назначения:

(Применяются в военной, авиационной, аэрокосмической, морской, железнодорожной, горно- и нефтедобывающей отраслях промышленности)

«**FORSTAR**» (основан в 1998 г.)

ВЧ соединители, коаксиальные кабели,  
кабельные сборки и микроволновые компоненты:

(Применяются в телекоммуникациях гражданского и специального назначения, в средствах связи, РЛС, а так же военной, авиационной и аэрокосмической отраслях промышленности).



Телефон: 8 (812) 309-75-97 (многоканальный)

Факс: 8 (812) 320-03-32

Электронная почта: [ocean@oceanchips.ru](mailto:ocean@oceanchips.ru)

Web: <http://oceanchips.ru/>

Адрес: 198099, г. Санкт-Петербург, ул. Калинина, д. 2, корп. 4, лит. А