

# General Specifications

## Electrical Capacity (Resistive Load)

- For MRA:** 250mA @ 125V AC  
**For MRF or MRK:** 0.4VA maximum @ 28V AC/DC maximum  
 (Applicable Range 0.1mA ~ 0.1A @ 20mV ~ 28V)  
 Note: Find additional explanation of operating range in Supplement section.

## Other Ratings

- Contact Resistance:** 10 milliohms maximum for MRA; 50 milliohms maximum for MRF & MRK  
**Insulation Resistance:** 100 megohms minimum @ 500V DC  
**Dielectric Strength:** 1,000V AC minimum for 1 minute minimum for MRA  
 500V AC minimum for 1 minute minimum for MRF & MRK  
**Mechanical Life:** 30,000 operations minimum  
**Electrical Life:** 10,000 operations minimum  
**Range of Operating Torque:** 0.02 ~ 0.07Nm for MRA; 0.005 ~ 0.02Nm for MRF & MRK  
**Contact Timing:** Nonshorting (break-before-make)  
 MRA – self-cleaning, sliding contact; MRF & MRK – self-cleaning, rotary contactor disk  
**Indexing:** 30°

## Materials & Finishes

- Shaft:** Brass with nickel plating  
**Stopper Plate:** Steel with zinc plating for MRA & MRK; polyamide cover with stopper for MRF  
**Bushing/Housing:** Zinc alloy with zinc plating  
**Movable Contacts:** Copper with silver plating for MRA; phosphor bronze with gold plating for MRF & MRK  
**End Contacts & Terminals:** Brass with silver plating for MRA; phosphor bronze with gold plating for MRF & MRK  
**Common Contacts & Terminals:** Brass with silver plating for MRA; phosphor bronze with gold plating for MRF & MRK  
**Base:** Diallyl phthalate for MRA; fiberglass reinforced polyamide for MRF & MRK

## Environmental Data

- Operating Temperature Range:** -10°C through +70°C (+14°F through +158°F)  
**Humidity:** 90 ~ 95% humidity for 96 hours @ 40°C (104°F)  
**Vibration:** 10 ~ 55Hz with peak-to-peak amplitude of 1.5mm traversing the frequency range & returning in 1 minute; 3 right angled directions for 2 hours  
**Shock:** 50G (490m/s<sup>2</sup>) acceleration (tested in 3 right angled directions, with 3 shocks in each direction)  
**Sealing:** MRK model meets IP67 of IEC60529 standards

## Installation

- Mounting Torque:** .686Nm (6.08 lb•in)  
**Cap Installation Force:** 19.6 ~ 29.4N (4.41 ~ 6.61 lbf) for MRA & MRK

## Processing

- Soldering Time & Temperature:** Wave Soldering for MRA: See Profile A in Supplement section.  
 Wave Soldering for MRF & MRK: See Profile B in Supplement section.  
 Manual Soldering for MRA: See Profile A in Supplement section.  
 Manual Soldering for MRF & MRK: See Profile B in Supplement section.  
**Cleaning:** Automated cleaning recommended. Stopper plate, as well as washers for MRA & MRK, must be in place to maintain automated cleaning. See Cleaning specifications in Supplement section.

## Standards & Certifications

MRA, MRF, & MRK models have not been tested for UL recognition or CSA certification. These switches are designed for use in a low-voltage, low-current, logic-level circuit. When used as intended in a logic-level circuit, the results do not produce hazardous energy.

# Distinctive Characteristics

Low profile body of MRF model accommodates space limitations required for PCB mounting. For the MRA and MRK bushing mount models, the range of behind panel body depths is .323" to .669" (8.2mm to 17.0mm).

Positive detent mechanism for distinct feel and audible feedback.

Metal bushing and housing construction increases durability.

Adjustable stopper plate allows 2–12 position settings.

High contact reliability achieved by the self-cleaning contact mechanism.

Break-before-make contact timing with sliding contacts in MRA and rotary contactor disk in MRF and MRK models.

Interior housing seal and molded-in PC terminals, plus shaft rubber o-ring on MRA and MRK and polyamide cover on MRF model, allow cleaning after automated soldering.

MRK model meets IP67 of IEC60529 specifications (similar to NEMA 4 & 13).



Actual Size



- Toggles
- Rockers
- Pushbuttons
- Illuminated PB
- Programmable
- Keylocks
- Rotaries**
- Slides
- Tactiles
- Tilt
- Touch
- Indicators
- Accessories
- Supplement

### TYPICAL SWITCH ORDERING EXAMPLE

**MR**

**A**

**206**

**A**



#### Actuators & Terminals

<b>A</b>	Shaft Actuated with PC Terminals
<b>F</b>	Low Profile Screwdriver Actuated with PC Terminals
<b>K</b>	Low Profile Shaft Actuated with PC Terminals

#### Poles & Circuits

<b>112</b>	SP with 2-12 Positions
<b>206</b>	DP with 2-6 Positions
<b>403</b>	4P with 2-3 Positions

#### Knobs

<b>A</b>	Plain Black
<b>B</b>	Small Color Tipped
<b>C</b>	Large Color Tipped

#### Colors

For Plain Knob	
<b>No Code</b>	Black
For Color Tipped	
<b>A</b>	Black
<b>B</b>	White
<b>C</b>	Red
<b>E</b>	Yellow
<b>F</b>	Green
<b>G</b>	Blue
<b>H</b>	Gray

### DESCRIPTION FOR TYPICAL ORDERING EXAMPLE

**MRA206-A**

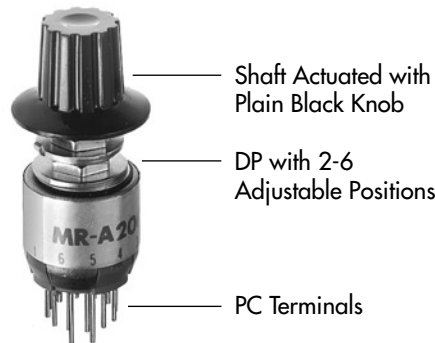

### ACTUATORS & TERMINALS

**A** Shaft Actuated with PC Terminals



Shaft Terminal

**F** Low Profile Screwdriver Actuated with PC Terminals



Slotted for Screwdriver Terminal

**K** Low Profile Shaft Actuated with PC Terminals



Shaft Terminal

Toggles  
 Rockers  
 Pushbuttons  
 Illuminated PB  
 Programmable  
 Keylocks  
 Rotaries  
 Slides  
 Tactiles  
 Tilt  
 Touch  
 Indicators  
 Accessories  
 Supplement

POLES & CIRCUITS					
Pole	Model	Number of Positions	Stopper Settings	Number of Terminals	Schematics
SP	MRA112	2-12	2, 3, 4, . . . 12	1 COM, 12 LOAD	
	MRF112	2-12	2, 3, 4, . . . 12	1 COM, 12 LOAD	
	MRK112	2-12	2, 3, 4, . . . 12	1 COM, 12 LOAD	
DP	MRA206	2-6	2, 3, 4, 5, 6	2 COM, 12 LOAD	
	MRF206	2-6	2, 3, 4, 5, 6	2 COM, 12 LOAD	
	MRK206	2-6	2, 3, 4, 5, 6	2 COM, 12 LOAD	
4P	MRA403	2-3	2, 3	4 COM, 12 LOAD	
	MRF403	2-3	2, 3	4 COM, 12 LOAD	
	MRK403	2-3	2, 3	4 COM, 12 LOAD	

## POSITION SETTING FOR MRA, MRF, & MRK MODELS

Each switch is supplied with the stopper set for the maximum number of positions allowed for that model. Prior to installation, the desired position setting should be made. Contact factory for continuous rotation.

### MRF Models

1. Remove the protective cover from the switch body.
2. Turn the shaft counterclockwise to the extreme left by using a screwdriver.
3. Inside the cover is a magnifying lens which would be positioned over the number which is to be the maximum position used; when the cover is then snapped into the switch, the projection beside the lens fits into the correct hole for setting the stop.



### MRK & MRA Models

1. Using the actuator knob, turn the shaft counterclockwise to the extreme left. If the shaft is not turned counterclockwise to the extreme left, proper setting cannot be achieved. At this extreme position, the white line on the knob points to the number 1 position shown on the side of the switch.
2. Remove the knob from the shaft and loosen the nut far enough to allow raising the stopper plate, plus washer(s), for resetting to the desired position.
3. Note the position numbers on the side of the switch; these correspond to the terminal numbers and stopper holes. Insert the stopper in the hole numbered for the maximum desired number of stop settings. Satisfactory switch functioning cannot be assured if the stopper plate is not properly positioned.
4. Tighten the nut (beveled side up) firmly against the stopper plate.

### Standard Mounting Hardware Packaged Loose with Each Switch:



### Factory Assembled:

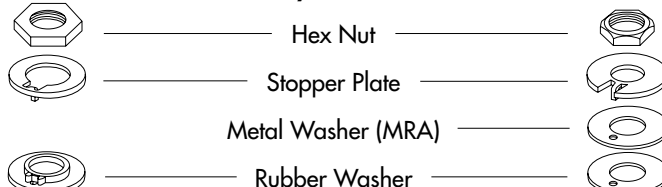

Toggle  
Rockers  
Pushbuttons  
Illuminated PB  
Programmable  
Keylocks  
Rotaries  
Slides  
Tactiles  
Tilt  
Touch  
Indicators  
Accessories  
Supplement

## TYPICAL SWITCH DIMENSIONS

### MRA • PC Terminals



**MRA112**

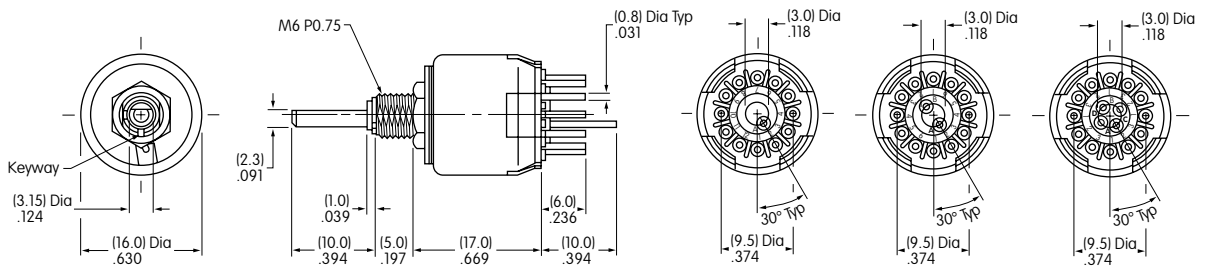

### MRF • PC Terminals



**MRF403**

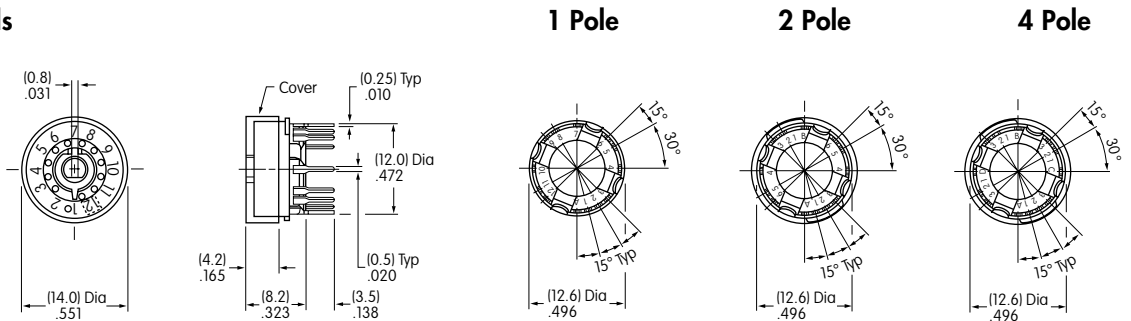

### MRK • PC Terminals



**MRK112**

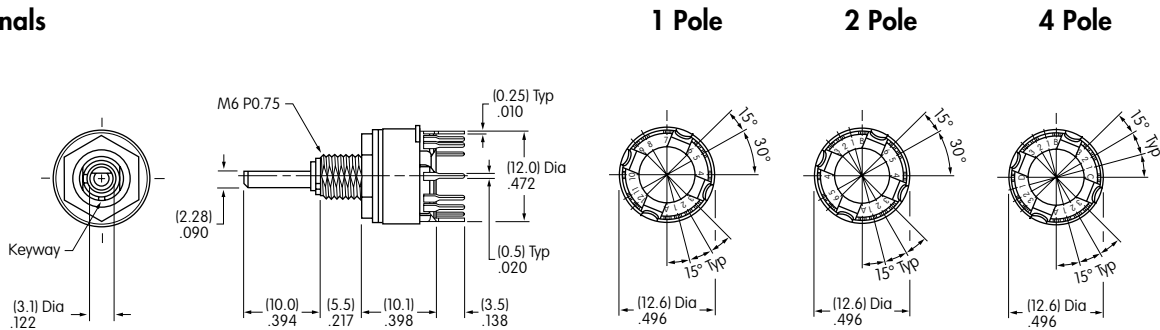

MRK devices are designed to be panel mounted. Installation without panel mounting will affect reliability.

## FOOTPRINTS

Single Pole  
MRA112

Double Pole  
MRA206

Four Pole  
MRA403

Single Pole  
MRF112  
MRK112

Double Pole  
MRF206  
MRK206

Four Pole  
MRF403  
MRK403

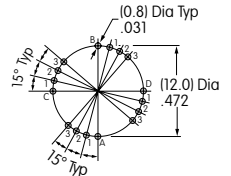
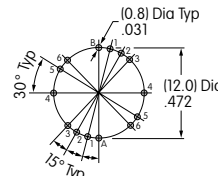
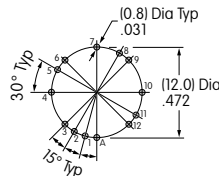
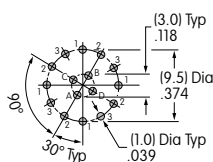
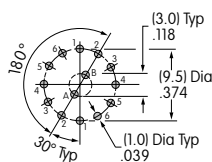
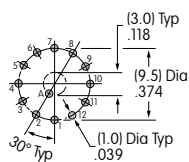

## KNOBS

### A AT433 Plain Black

Material:  
Polyacetal

Color:  
Black  
only



### B AT4103 Small Color Tipped

Base Material:  
Polyester  
Base Color:  
Black

Polyamide Tip  
Colors:  
A, B, C, E, F, G, H



### C AT4104 Large Color Tipped

Base Material:  
Polyester  
Base Color:  
Black

Polyamide Tip  
Colors:  
A, B, C, E, F, G, H



Color Codes: **A** Black **B** White **C** Red **E** Yellow **F** Green **G** Blue **H** Gray

## PANEL CUTOUTS & MAXIMUM EFFECTIVE PANEL THICKNESS

### MRA & MRK

#### Nonsealed Panel

Without  
Keyway

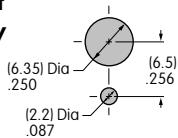

With  
Keyway

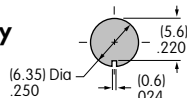

### MRK

#### Sealed Panel

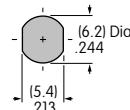

With Standard Hardware on Nonsealed Panel:  
MRA .067" (1.7mm) MRK .087" (2.2mm)

Without Locking Ring on Nonsealed Panel:  
MRA .098" (2.5mm) MRK .118" (3.0mm)

With AT513M & AT535 only on Sealed Panel:  
MRK .106" (2.7mm)

## STANDARD MOUNTING HARDWARE

### AT513M Metric Hexagon Nut

Material:  
Brass, nickel plating  
1 for MRA; 1 for MRK



### AT545 Locking Ring

Material:  
Steel, chromate over zinc plating  
1 for MRA; 1 for MRK

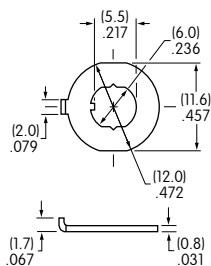

### AT509 Lockwasher

Material:  
Steel, chromate over zinc plating  
1 for MRA; 1 for MRK



### AT535 Rubber Ring

Material:  
Nitrile butadiene rubber  
1 for MRK



## OPTIONAL SUPPORT BRACKET

### AT543 Support Bracket for MRK

Material:  
Steel with tin plating

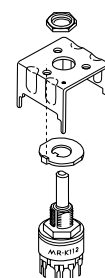
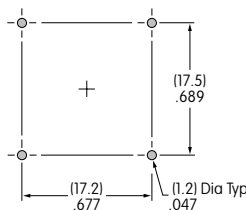

A support bracket is needed when the MRK is mounted only to a PC board and does not have the bushing through a panel.



Компания «Океан Электроники» предлагает заключение долгосрочных отношений при поставках импортных электронных компонентов на взаимовыгодных условиях!

Наши преимущества:

- Поставка оригинальных импортных электронных компонентов напрямую с производств Америки, Европы и Азии, а так же с крупнейших складов мира;
- Широкая линейка поставок активных и пассивных импортных электронных компонентов (более 30 млн. наименований);
- Поставка сложных, дефицитных, либо снятых с производства позиций;
- Оперативные сроки поставки под заказ (от 5 рабочих дней);
- Экспресс доставка в любую точку России;
- Помощь Конструкторского Отдела и консультации квалифицированных инженеров;
- Техническая поддержка проекта, помощь в подборе аналогов, поставка прототипов;
- Поставка электронных компонентов под контролем ВП;
- Система менеджмента качества сертифицирована по Международному стандарту ISO 9001;
- При необходимости вся продукция военного и аэрокосмического назначения проходит испытания и сертификацию в лаборатории (по согласованию с заказчиком);
- Поставка специализированных компонентов военного и аэрокосмического уровня качества (Xilinx, Altera, Analog Devices, Intersil, Interpoint, Microsemi, Actel, Aeroflex, Peregrine, VPT, Syfer, Eurofarad, Texas Instruments, MS Kennedy, Miteq, Cobham, E2V, MA-COM, Hittite, Mini-Circuits, General Dynamics и др.);

Компания «Океан Электроники» является официальным дистрибьютором и эксклюзивным представителем в России одного из крупнейших производителей разъемов военного и аэрокосмического назначения «**JONHON**», а так же официальным дистрибьютором и эксклюзивным представителем в России производителя высокотехнологичных и надежных решений для передачи СВЧ сигналов «**FORSTAR**».



## JONHON

«**JONHON**» (основан в 1970 г.)

Разъемы специального, военного и аэрокосмического назначения:

(Применяются в военной, авиационной, аэрокосмической, морской, железнодорожной, горно- и нефтедобывающей отраслях промышленности)

«**FORSTAR**» (основан в 1998 г.)

ВЧ соединители, коаксиальные кабели,  
кабельные сборки и микроволновые компоненты:

(Применяются в телекоммуникациях гражданского и специального назначения, в средствах связи, РЛС, а так же военной, авиационной и аэрокосмической отраслях промышленности).



Телефон: 8 (812) 309-75-97 (многоканальный)

Факс: 8 (812) 320-03-32

Электронная почта: [ocean@oceanchips.ru](mailto:ocean@oceanchips.ru)

Web: <http://oceanchips.ru/>

Адрес: 198099, г. Санкт-Петербург, ул. Калинина, д. 2, корп. 4, лит. А