

LOC		DIST		REVISIONS			
ES	00	P	LTN	DESCRIPTION	DATE	DMN	APVD
		D7		ADD NEW PART -24	20JAN2015	AY	SZ

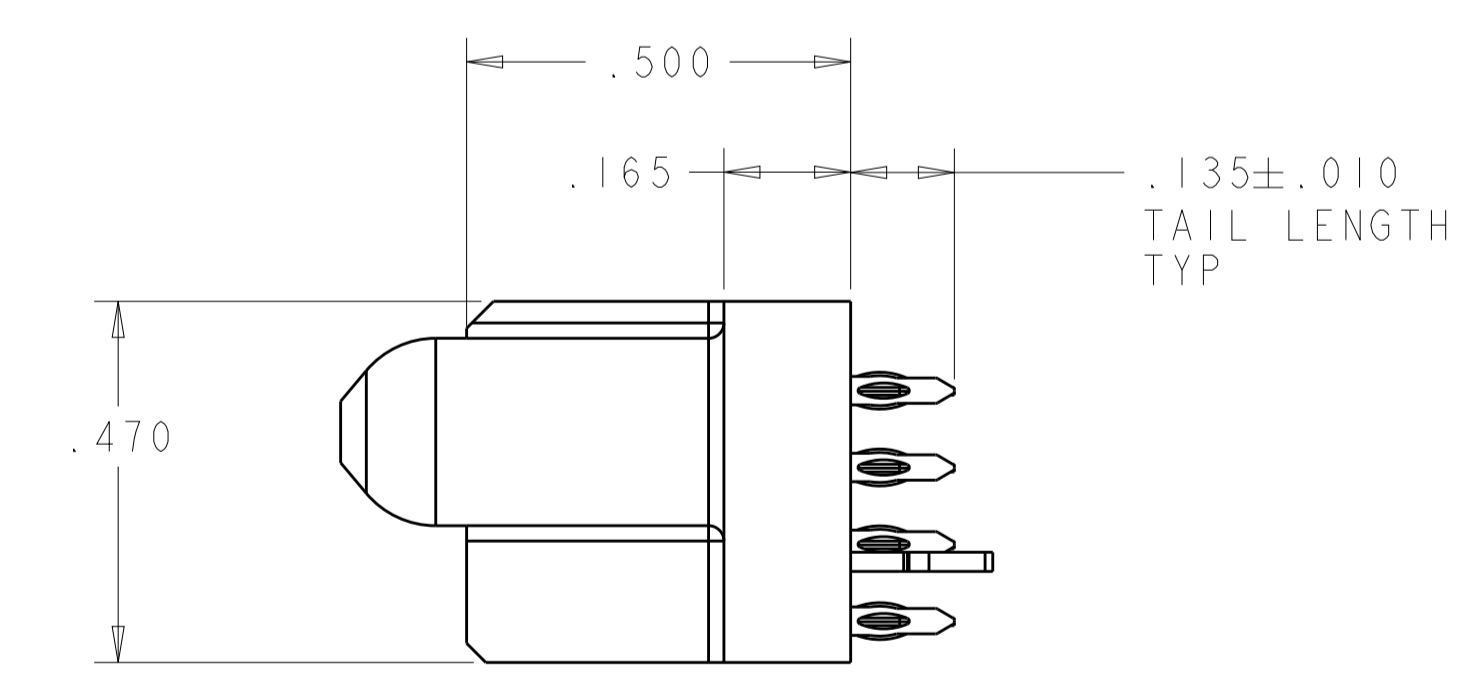
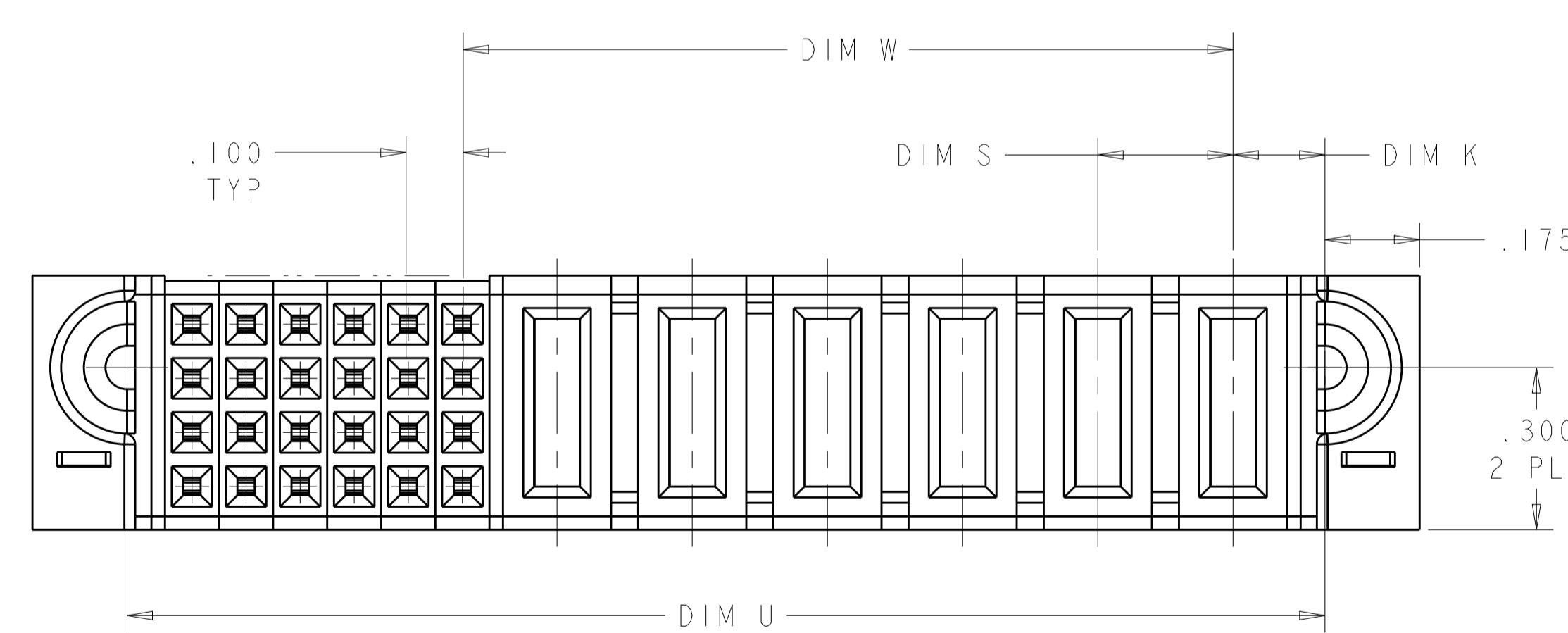
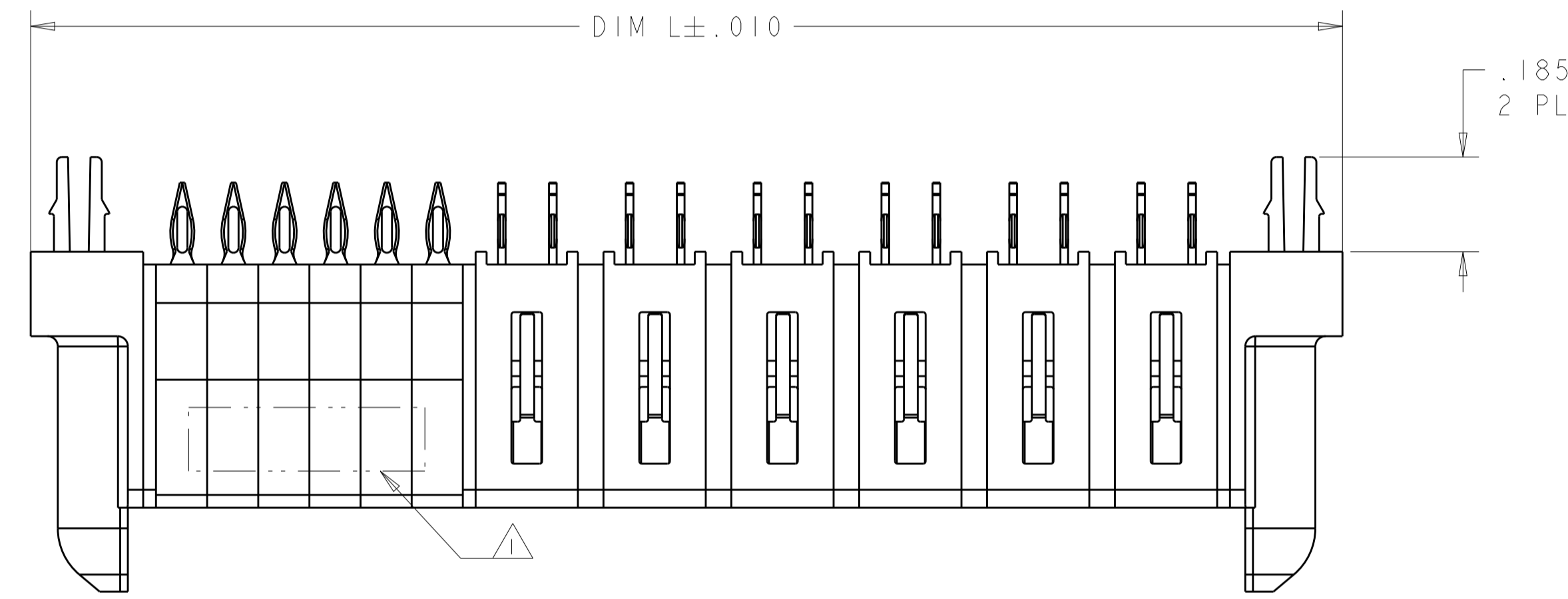
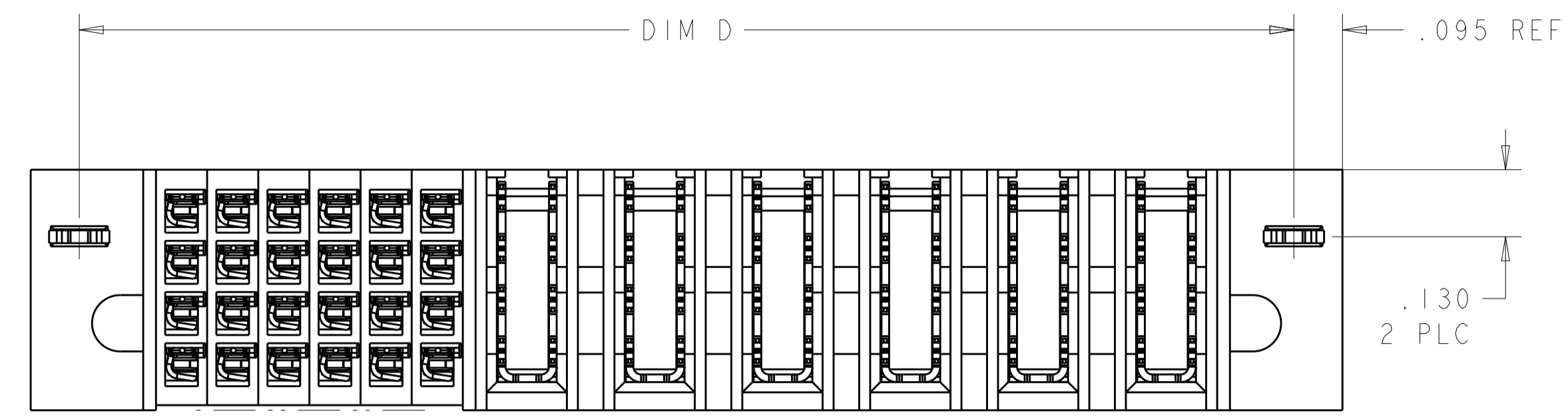

- ① "AMP", PART NUMBER AND DATE CODE TO BE MARKED IN AREA SHOWN PARTS UNDER 2.00 LONG MAY BE MARKED ON BOTH SIDES;
- ② HOUSING - GLASS FILLED HIGH TEMP THERMO PLASTIC, UL94 V-0
 SIGNAL CONTACT - HIGH CONDUCTIVITY COPPER ALLOY
 POWER CONTACT - HIGH CONDUCTIVITY COPPER ALLOY
- ③ CONTACT PLATING:
 NOBLE METAL PLATING ON FUNCTIONAL AREA OF POWER AND SIGNAL CONTACTS.
- ④ MECHANICAL CONNECTOR KEEP OUT ZONE
- ⑤ DATUM AND BASIC DIMENSIONS ESTABLISHED BY CUSTOMER
- ⑥ PCB - ALL HOLE DIAMETERS ARE FINISHED HOLE SIZES
- ⑦ PCB - 0.0453 ±.0010 DRILLED HOLES PLATED WITH .0003 MIN Sn
 OVER .001 TO .003 Cu PLATING TO ACHIEVE A .040 ±.003 HOLE
- ⑧ THIS DIMENSION PLEASE REFER TO TABLE

THIS DRAWING IS A CONTROLLED DOCUMENT.		DMN S.ZHAO 18JUN2008	TE Connectivity NAME VERTICAL RECEPTACLE W/ P+S MULTI-BEAM XLE PRODUCT SPEC 108-2292 APPLICATION SPEC 114-13251 WEIGHT - CUSTOMER DRAWING	SIZE A1	CAGE CODE 00779	DRAWING NO C=6450862	RESTRICTED TO -
DIMENSIONS: INCHES	TOLERANCES UNLESS OTHERWISE SPECIFIED:	CHK S.ZHAO 18JUN2008		SCALE 2:1	SHEET 1	OF 9	REV D7
0 PLC ±. 1 PLC ±.1 2 PLC ±.02 3 PLC ±.005 4 PLC ±.0020 ANGLES ±.7°	FINISH ③	APVD S.ZHAO 18JUN2008					
MATERIAL ②							

THIS DRAWING IS UNPUBLISHED. RELEASED FOR PUBLICATION 20
 © COPYRIGHT 20 BY - TE CONNECTIVITY ALL RIGHTS RESERVED.

LOC	DIST	REVISIONS					
		P	LTN	DESCRIPTION	DATE	DWN	APVD
ES	00	-		SEE SHEET 1	-	-	-

(D7)	.300	2.240	1.890	2.050	1.450	.195	5ACP + 8S	2-6450862-4
(D5)	.250	3.240	2.890	3.050	1.925	.170	8P + 32S	2-6450862-3
	.250	3.240	2.890	3.050	1.925	.170	8P + 32S	2-6450862-2
	.115	.945	.595	.755	.2725	.1025	2LP + 8S	2-6450862-1
	.200	3.265	2.915	3.075	2.175	.145	11HDP + 24S	1-6450862-8
	△	3.740	3.390	3.550	2.625	.170	3ACP + 8P + 24S	1-6450862-7
	.250	2.415	2.065	2.225	1.425	.145	6P + 20S	1-6450862-6
	.200	3.265	2.915	3.075	1.975	.145	10HDP + 32S	1-6450862-5
	△	2.420	2.070	2.230	1.330	.145	5P + 2LP + 24S	1-6450862-4
	.250	3.790	3.440	3.600	2.900	.145	12P + 16S	6450862-6
	△	2.915	2.565	2.725	2.045	.170	6P + 2HDP + 20S	6450862-5
	.115	.970	.620	.780	.2725	.1275	2LP + 8S	6450862-4
	.200	3.065	2.715	2.875	1.975	.145	10HDP + 24S	6450862-3
	.250	2.595	2.215	2.375	1.425	.170	6P + 24S	6450862-1
	DIM S	DIM L	DIM U	DIM D	DIM W	DIM K	DESCRIPTION	PART NUMBER

THIS DRAWING IS A CONTROLLED DOCUMENT.		DWN S. ZHAO 18JUN2008	 TE Connectivity
DIMENSIONS: INCHES		CHK S. ZHAO 18JUN2008	
TOLERANCES UNLESS OTHERWISE SPECIFIED:		APVD S. ZHAO 18JUN2008	
0 PLC ±.1 1 PLC ±.1 2 PLC ±.02 3 PLC ±.005 4 PLC ±.0020 ANGLES ±.0020		PRODUCT SPEC 108-2292 APPLICATION SPEC 114-13251 WEIGHT - CUSTOMER DRAWING	
MATERIAL - FINISH -		SIZE A1 CAGE CODE 00779 DRAWING NO. 6450862 SCALE 2:1 SHEET 2 OF 9 REV D7	NAME VERTICAL RECEPTACLE W/ P+S MULTI-BEAM XLE RESTRICTED TO -

LOC	DIST	REVISIONS			
ES	00	REV	DATE	BY	APPD
		-	SEE SHEET 1	-	-

PART NUMBER	ROWS	SIGNAL						POWER							
		6	5	4	3	2	1	P6	P5	P4	P3	P2	P1		
6450862-1	D C B A	AP	AP	AP	AP	AP	AP	GS	GS	GS	GS	GS	GS		
		AP	AP	AP	AP	AP	AP	GS	GS	GS	GS	GS	GS		
		AP	AP	AP	AP	AP	AP	GS	GS	GS	GS	GS	GS		
		AP	AP	AP	AP	AP	AP	GS	GS	GS	GS	GS	GS		
6P + 24S		HD												HD	

PART NUMBER	ROWS	SIGNAL						POWER									
		6	5	4	3	2	1	P10	P9	P8	P7	P6	P5	P4	P3	P2	P1
6450862-3	D C B A	AP	AP	AP	AP	AP	AP	GS	GS	GS	GS	GS	GS	GS	GS	GS	GS
		AP	AP	AP	AP	AP	AP	GS	GS	GS	GS	GS	GS	GS	GS	GS	GS
		AP	AP	AP	AP	AP	AP	GS	GS	GS	GS	GS	GS	GS	GS	GS	GS
		AP	AP	AP	AP	AP	AP	GS	GS	GS	GS	GS	GS	GS	GS	GS	GS
10HDP + 24S		HD												HD			

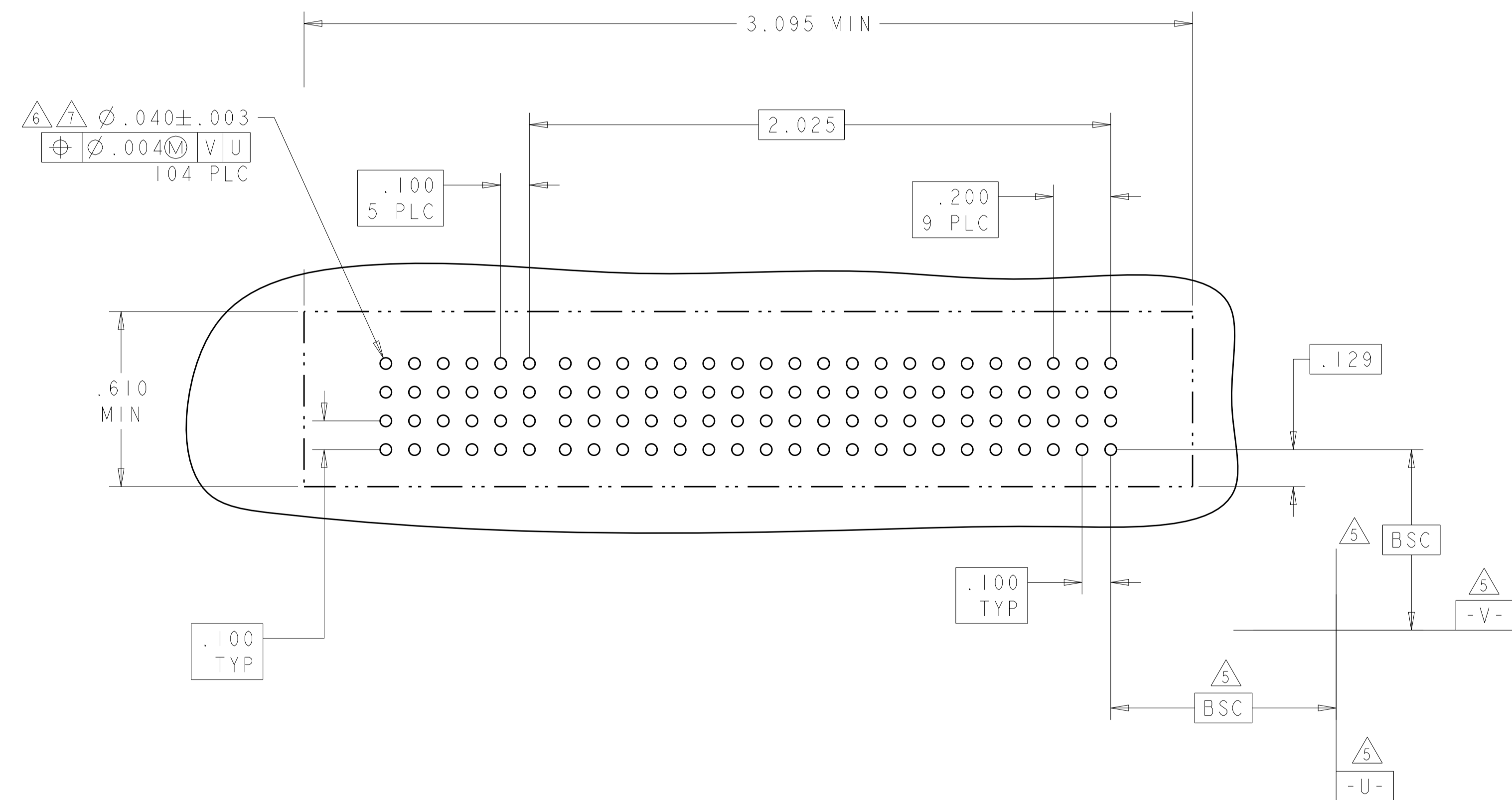
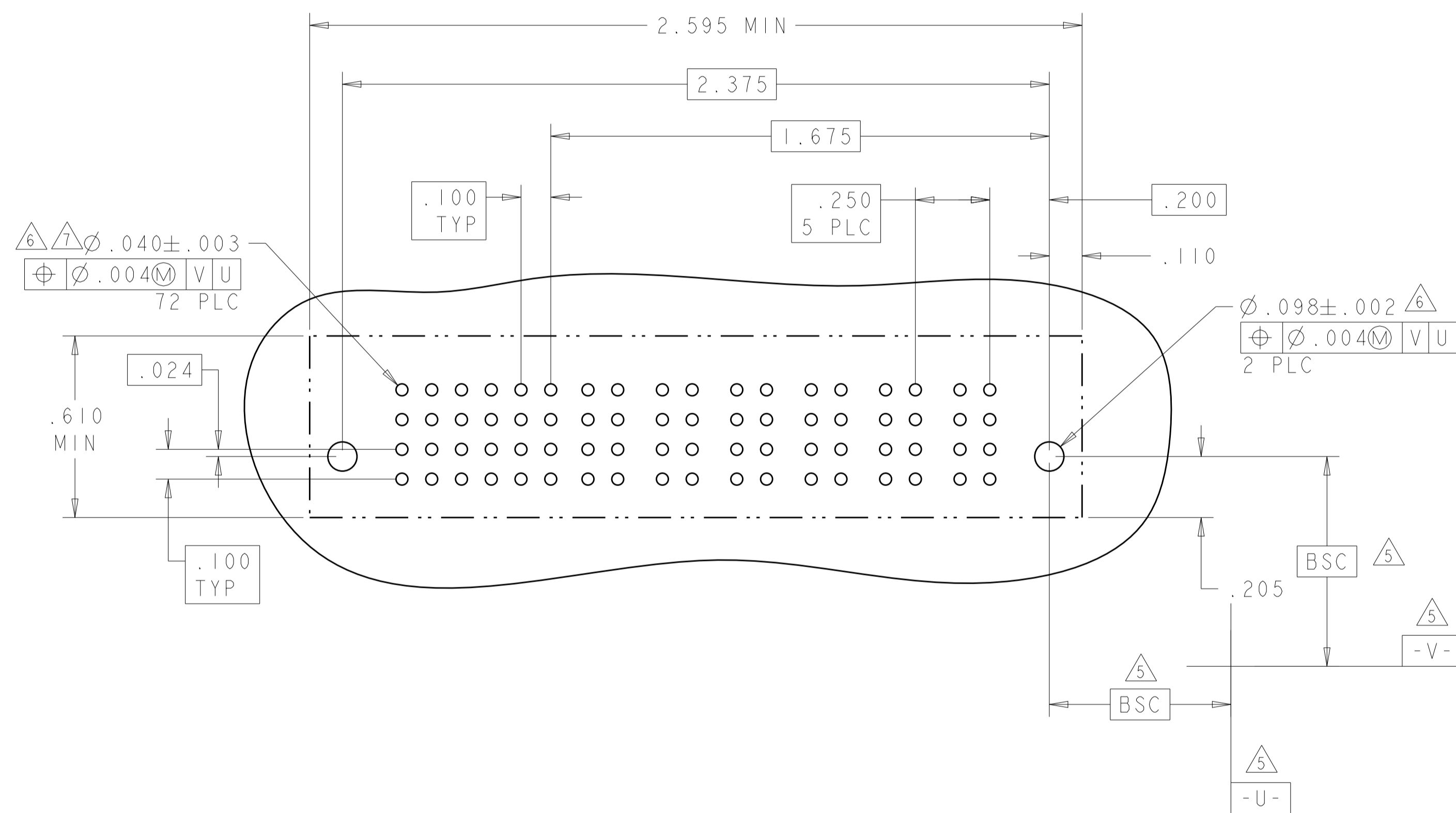

MFBL POWER CONTACT	GP
HOLD DOWN	HD
STD POWER CONTACT	GS
STD LP LOWER POWER CON.	LSI
SIGNAL CONTACT	AP
DESCRIPTION	CODE

THIS DRAWING IS A CONTROLLED DOCUMENT.

DIMENSIONS:	TOLERANCES UNLESS OTHERWISE SPECIFIED:	OWN	S. ZHAO	18JUN2008
INCHES	0 PLC ±.1	CHK	S. ZHAO	18JUN2008
	1 PLC ±.02	APPD	S. ZHAO	18JUN2008
	2 PLC ±.02	PRODUCT SPEC		
	3 PLC ±.005	APPLICATION SPEC		
	4 PLC ±.0020	SIZE	114-13251	
	ANGLES ±.2°	WEIGHT		
MATERIAL	FINISH	CUSTOMER DRAWING		

TE Connectivity
 VERTICAL RECEPTACLE W/ P+S MULTI-BEAM XLE
 A100779 ©=6450862
 SCALE 2:1 SHEET 3 OF 9 REV 07

LOC	DIST	REV	DATE	BY	APPV
ES	00				
		REVISIONS			
		DESCRIPTION	DATE	BY	APPV
		SEE SHEET 1			

PART NUMBER	ROWS	SIGNAL				POWER												
		4	3	2	1	P12	P11	P10	P9	P8	P7	P6	P5	P4	P3	P2	P1	
6450862-6	D C B A	AP	AP	AP	AP													
		AP	AP	AP	AP			GP				GS						
		AP	AP	AP	AP									GS				
		AP	AP	AP	AP										GS			

PART NUMBER	ROWS	SIGNAL					POWER							
		5	4	3	2	1	P6	P5	P4	P3	P2	P1		
I-6450862-6	D C B A	AP	AP	AP	AP	AP								
		AP	AP	AP	AP	AP			GP					
		AP	AP	AP	AP	AP							GS	
		AP	AP	AP	AP	AP								GS

NO CONTACT LOADED

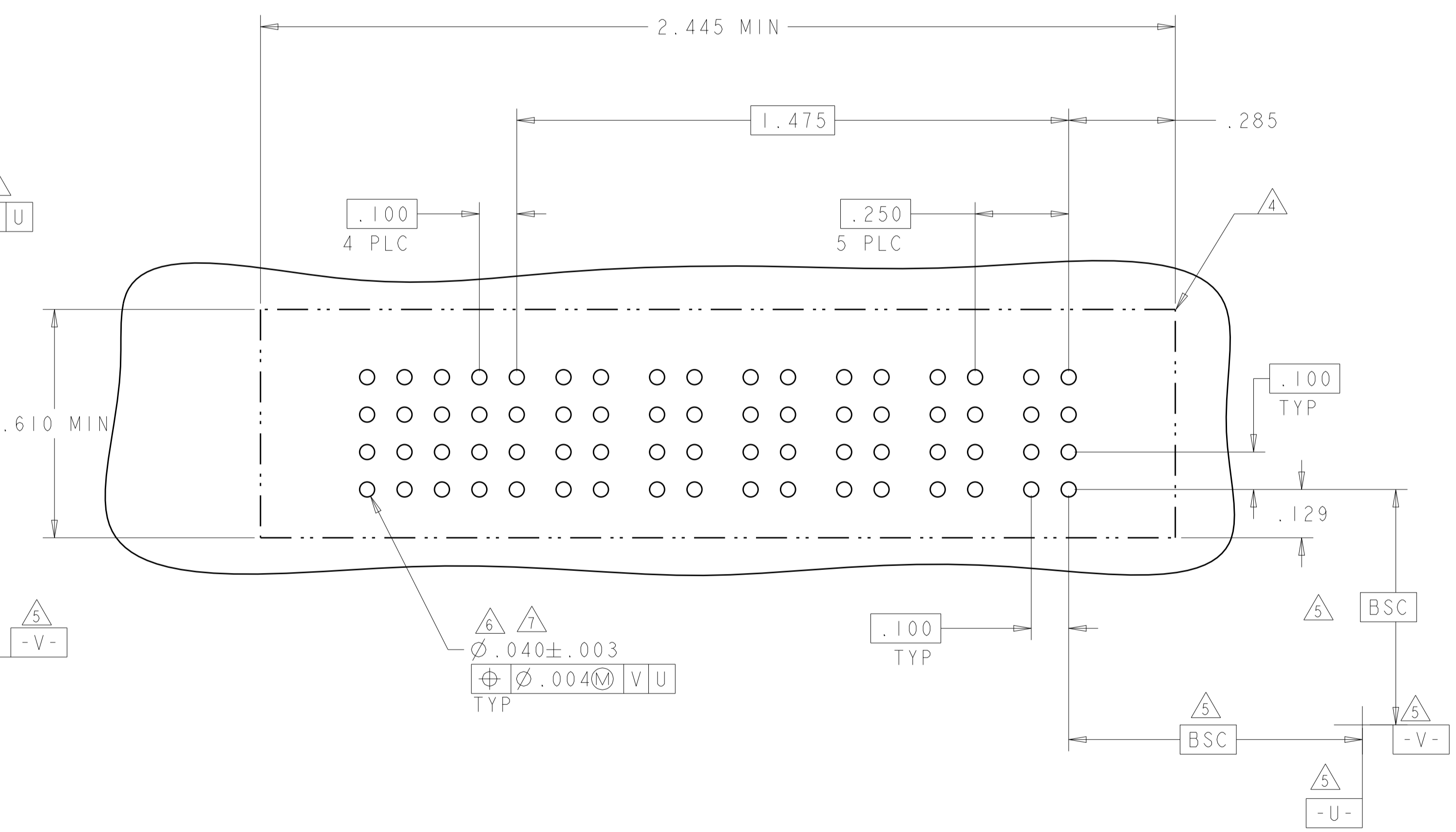
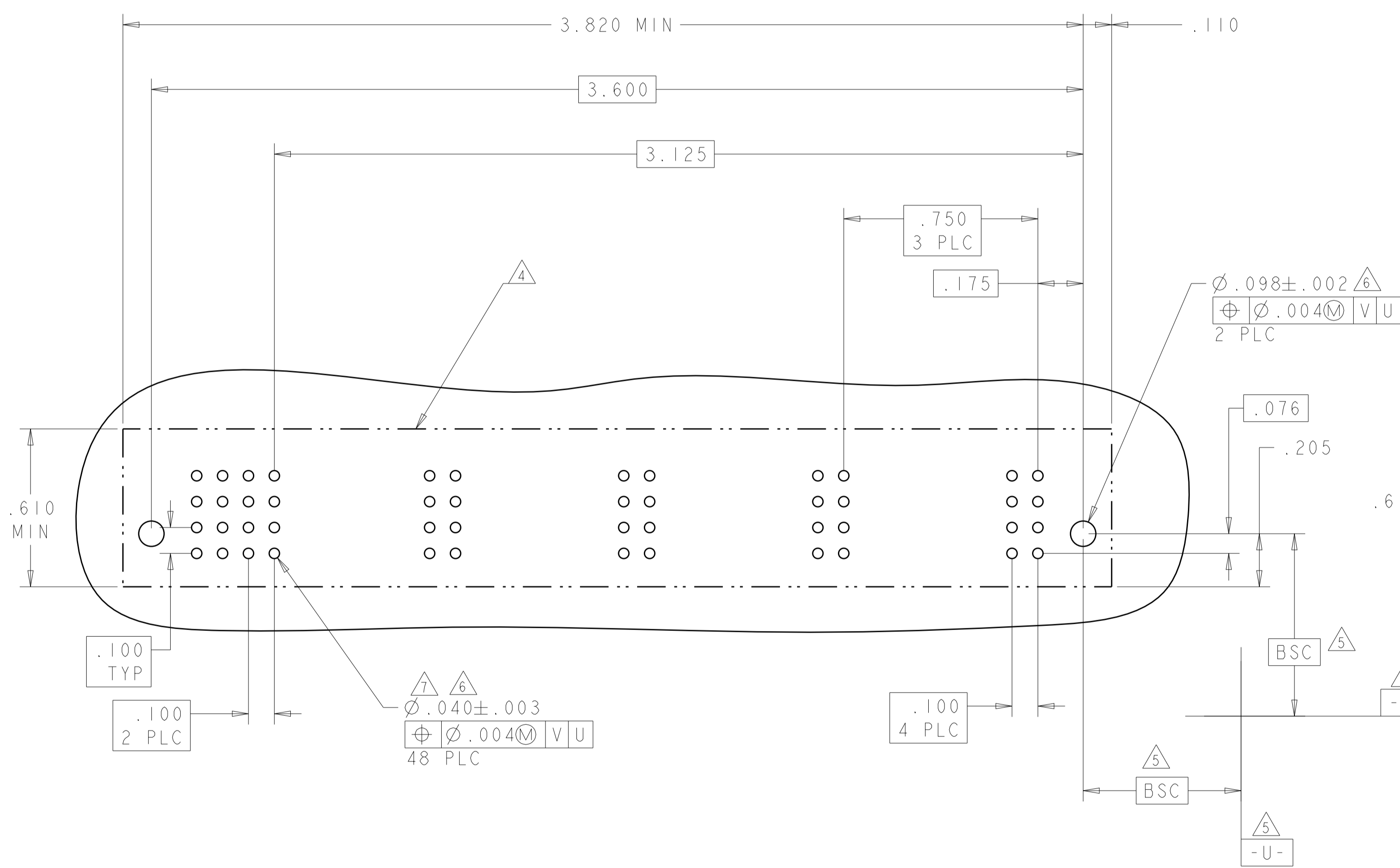

THIS DRAWING IS A CONTROLLED DOCUMENT.		OWN	S. ZHAO	18JUN2008
DIMENSIONS:		CHK	S. ZHAO	18JUN2008
INCHES		APPV	S. ZHAO	18JUN2008
TOLERANCES UNLESS OTHERWISE SPECIFIED:		PRODUCT SPEC		
0 PLC	±	108-2292		
1 PLC	±.1	APPLICATION SPEC		
2 PLC	±.02	114-13251		
3 PLC	±.005	WEIGHT		
4 PLC	±.0020	CUSTOMER DRAWING		
ANGLES	±.0020	SCALE 2:1		
FINISH	±.0020	SHEET 5 OF 9		
MATERIAL		REV D7		



NAME VERTICAL RECEPTACLE W/ P+S MULTI-BEAM XLE

SIZE CAGE CODE DRAWING NO RESTRICTED TO
 A100779 ©=6450862

LOC	DIST	REV	DATE	BY	APPV
ES	00				
REVISIONS			DESCRIPTION	DATE	BY
			SEE SHEET 1		

PART NUMBER	ROWS	SIGNAL						POWER													
		6	5	4	3	2	1	P11	P10	P9	P8	P7	P6	P5	P4	P3	P2	P1			
I-6450862-7	D C B A	AP	AP	AP	AP	AP	AP	GS	GS	GS	GS	GS	GS	GS	GP	GS	GS	GS			
		AP	AP	AP	AP	AP	AP	GS	GS	GS	GS	GS	GS	GS	GS	GS	GS				
		AP	AP	AP	AP	AP	AP	GS	GS	GS	GS	GS	GS	GS	GS	GS	GS				
3ACP + 8P + 24S		HD																		HD	

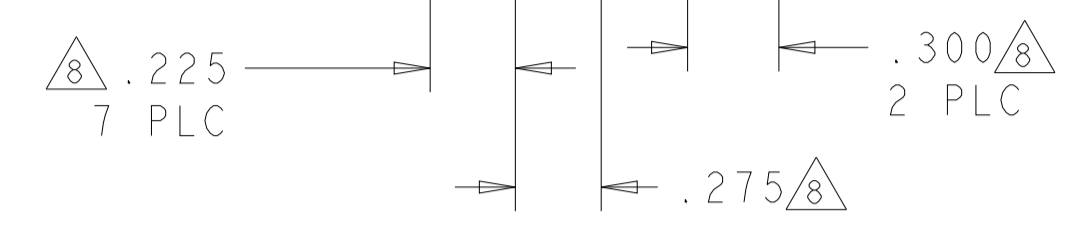

PART NUMBER	ROWS	SIGNAL						POWER													
		6	5	4	3	2	1	P11	P10	P9	P8	P7	P6	P5	P4	P3	P2	P1			
I-6450862-8	D C B A	AP	AP	AP	AP	AP	AP	GS	GS	GS	GS	GS	GS	GS	GS	GS	GS				
		AP	AP	AP	AP	AP	AP	GS	GS	GS	GS	GS	GS	GS	GS	GS	GS				
		AP	AP	AP	AP	AP	AP	GS	GS	GS	GS	GS	GS	GS	GS	GS	GS				
11HDP + 24S		HD																		HD	

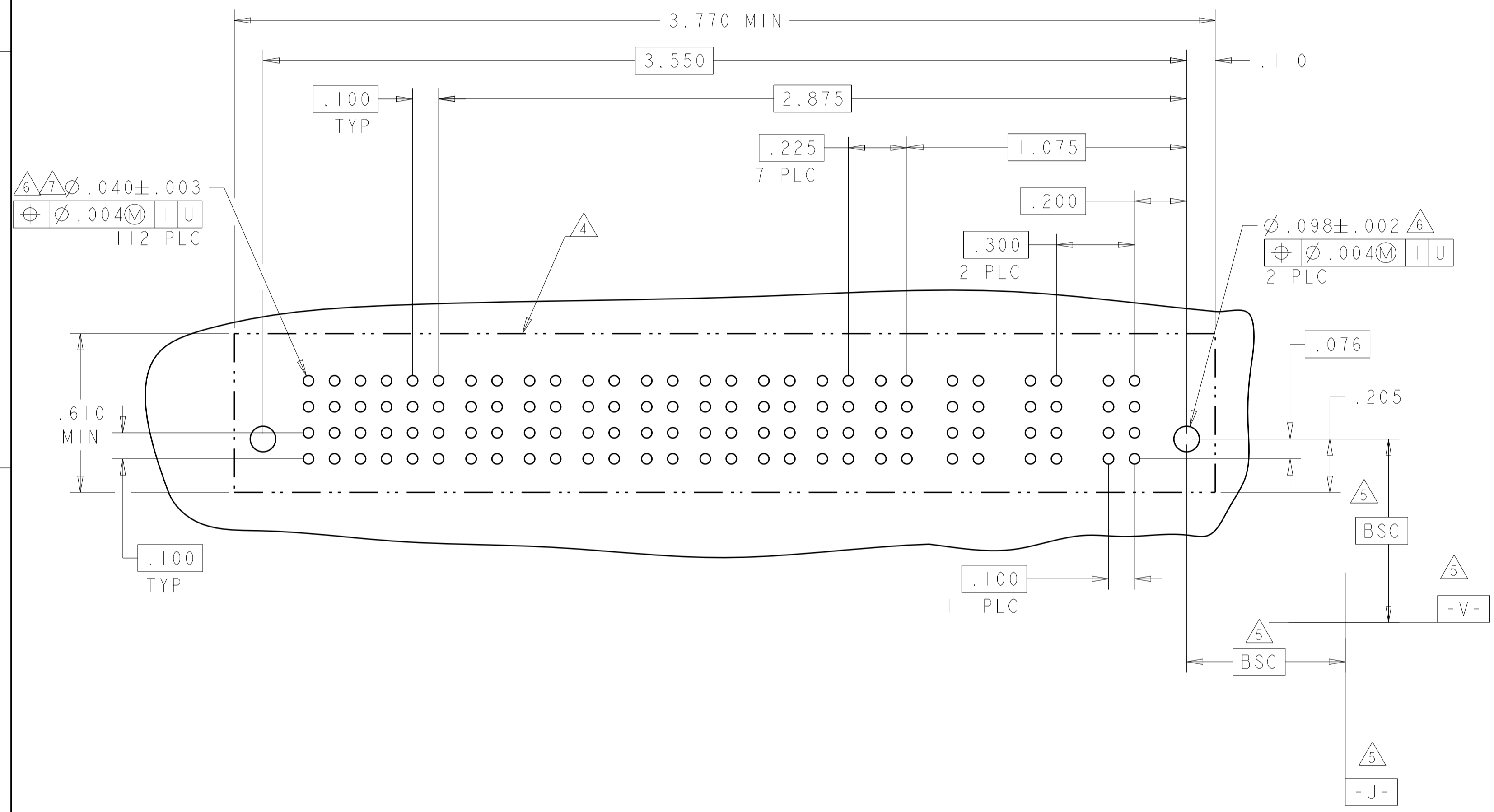
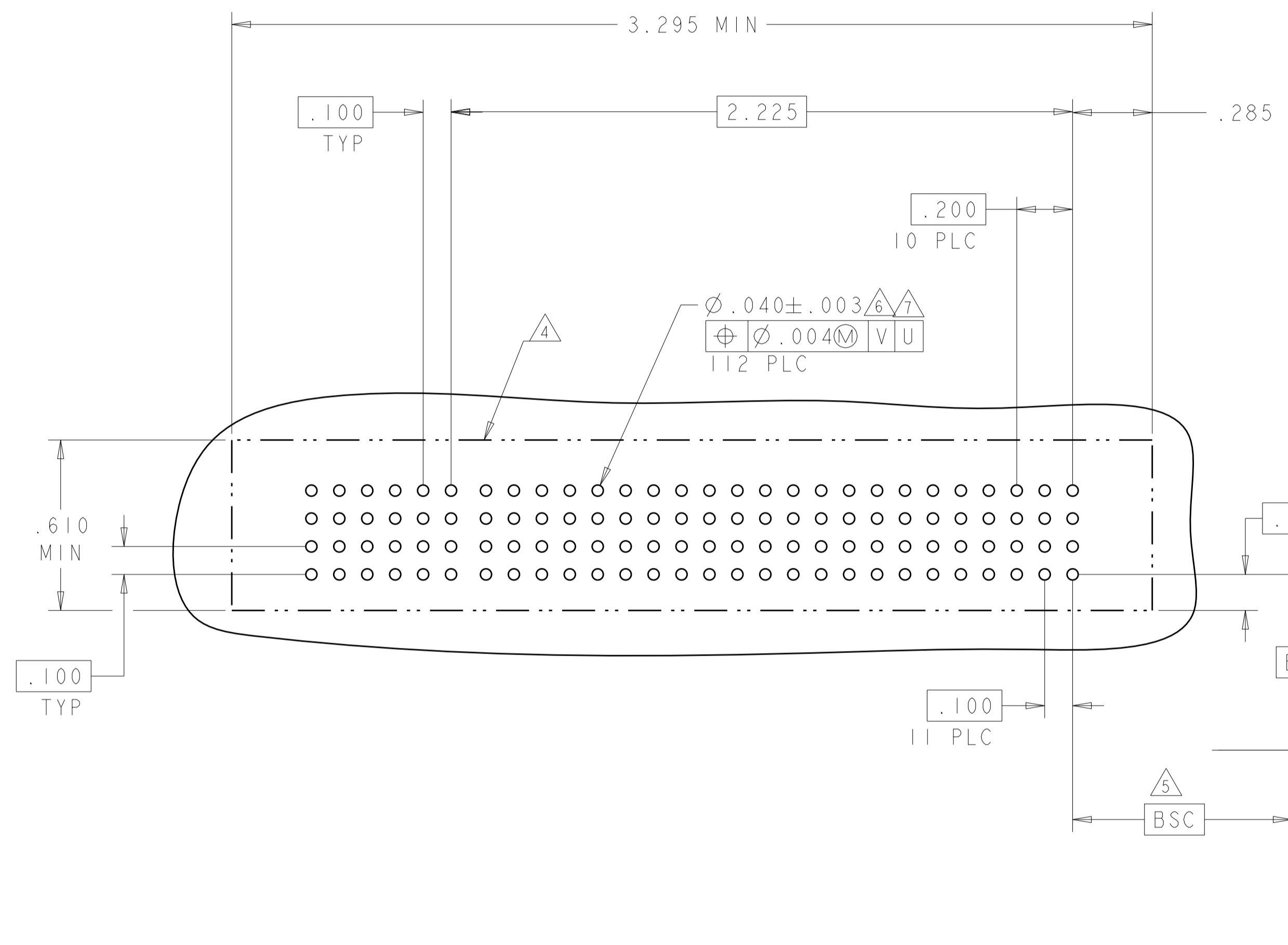

THIS DRAWING IS A CONTROLLED DOCUMENT.

DIMENSIONS:	TOLERANCES UNLESS OTHERWISE SPECIFIED:	OWN	18JUN2008
INCHES	0 PLC ±.1	CHK	18JUN2008
	1 PLC ±.1	APVD	18JUN2008
	2 PLC ±.02	NAME	
	3 PLC ±.02	VERTICAL RECEPTACLE W/ P+S	
	4 PLC ±.005	MULTI-BEAM XLE	
	5 PLC ±.0020	SIZE	CAGE CODE DRAWING NO
	ANGLES ±.2°	114-13251	RESTRICTED TO
MATERIAL	FINISH	WEIGHT	A100779C=6450862
CUSTOMER DRAWING		SCALE	2:1 SHEET 7 OF 9 REV 07

4805 (3/11)

LOC	DIST	REV	DATE	BY	APPV
ES	00				

PART NUMBER	ROWS	SIGNAL		POWER	
		2	1	P2	P1
2-6450862-1	D C B A	AP	AP	LSI	LSI
		AP	AP		
		AP	AP	HD	HD
		AP	AP		
2LP + 8S					

PART NUMBER	ROWS	SIGNAL								POWER							
		8	7	6	5	4	3	2	1	P8	P7	P6	P5	P4	P3	P2	P1
2-6450862-2	D C B A	AP	AP	AP	AP	AP	AP	AP	AP	GS	GS	GS	GS	GS	GS	GS	GS
		AP	AP	AP	AP	AP	AP	AP	AP	GS	GS	GS	GS	GS	GS	GS	GS
		AP	AP	AP	AP	AP	AP	AP	AP								
		AP	AP	AP	AP	AP	AP	AP	AP								
8P + 32S																	

PART NUMBER	ROWS	SIGNAL								POWER							
		8	7	6	5	4	3	2	1	P8	P7	P6	P5	P4	P3	P2	P1
2-6450862-3	D C B A	AP	AP	AP	AP	AP	AP	AP	AP	GP	GS	GS	GS	GS	GS	GS	GS
		AP	AP	AP	AP	AP	AP	AP	AP	GS	GS	GS	GS	GS	GS	GS	GS
		AP	AP	AP	AP	AP	AP	AP	AP								
		AP	AP	AP	AP	AP	AP	AP	AP								
8P + 32S																	

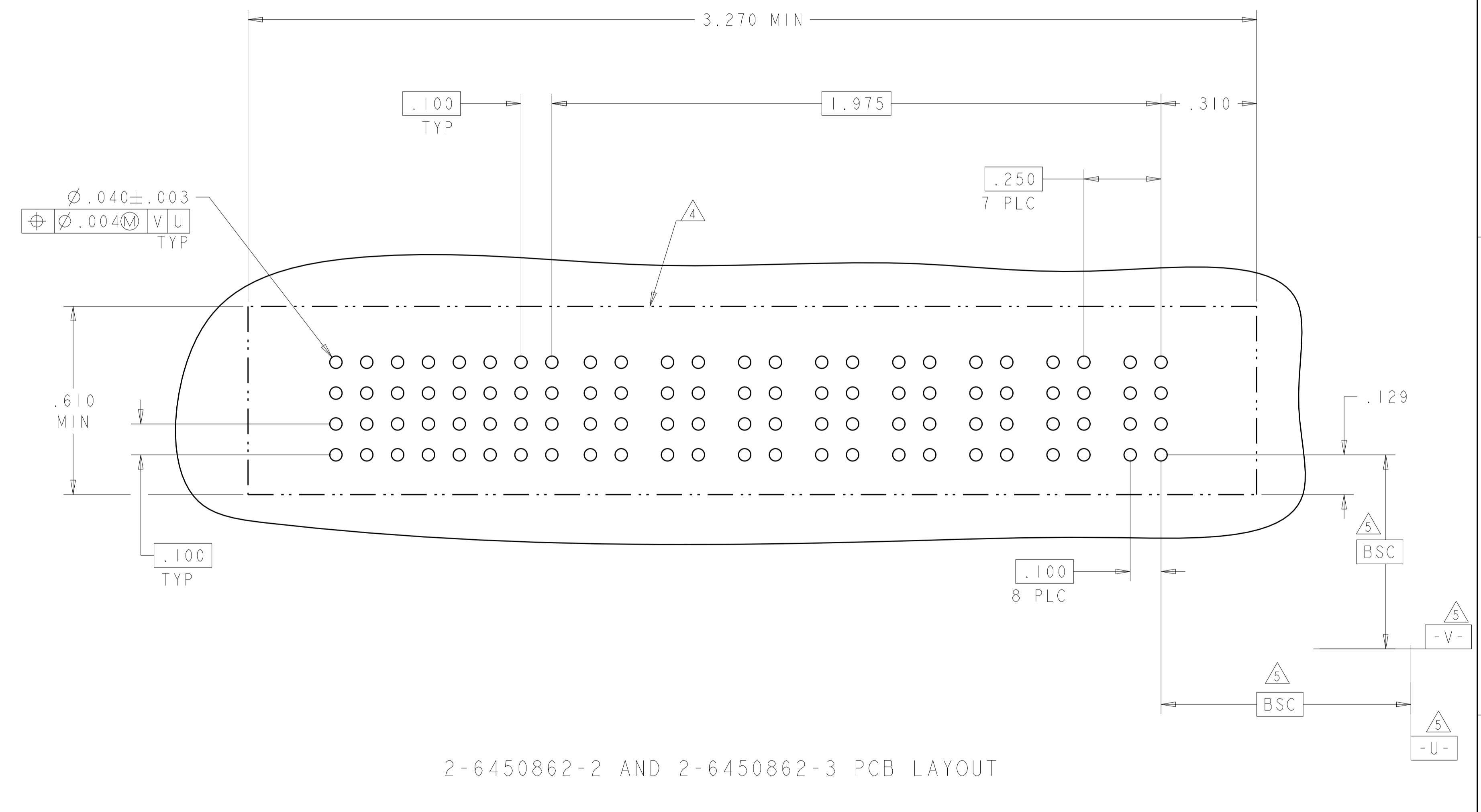
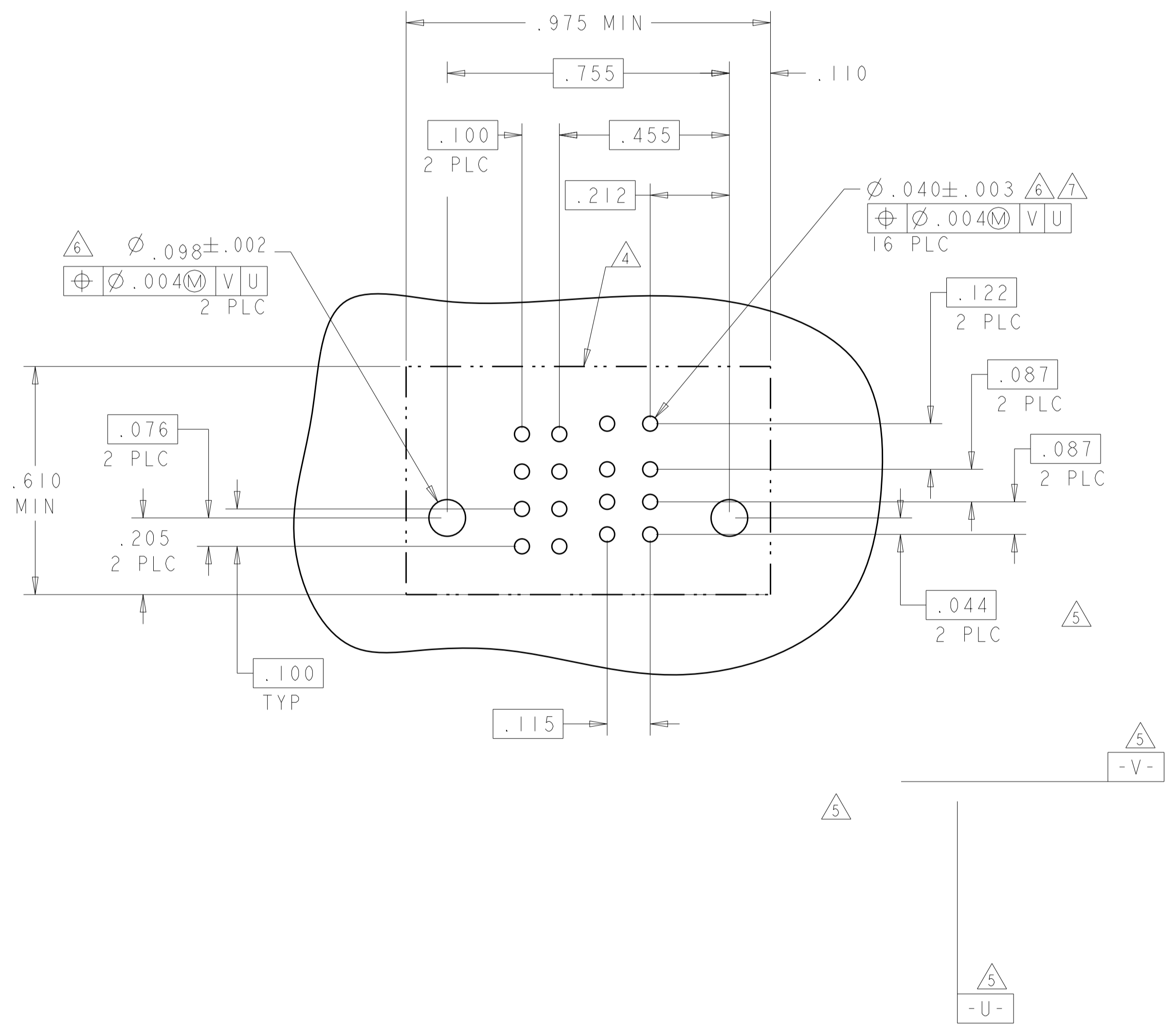

2-6450862-2 AND 2-6450862-3 PCB LAYOUT

THIS DRAWING IS A CONTROLLED DOCUMENT.		OWN: S. ZHAO 18JUN2008	 TE Connectivity
DIMENSIONS: INCHES		CHK: S. ZHAO 18JUN2008	
TOLERANCES UNLESS OTHERWISE SPECIFIED:		APVD: S. ZHAO 18JUN2008	NAME: VERTICAL RECEPTACLE W/ P+S MULTI-BEAM XLE
0 PLC ±.1 1 PLC ±.1 2 PLC ±.02 3 PLC ±.005 4 PLC ±.002 ANGLES ±.0020		PRODUCT SPEC: 108-2292	SIZE: A1
MATERIAL: FINISH:		APPLICATION SPEC: 114-13251	CAGE CODE: 6450862
		WEIGHT:	RESTRICTED TO: -
		CUSTOMER DRAWING	SCALE: 2:1 SHEET: 8 OF 9 REV: 07

LOC	DIST	REVISIONS			
P	LTN	DESCRIPTION	DATE	DWN	APVD
-	-	SEE SHEET 1	-	-	-

PART NUMBER	ROWS	SIGNAL		POWER				
		2	1	P5	P4	P3	P2	P1
2-6450862-4	D	AP	AP	GP	GS	GS	GS	GS
	C	AP	AP					
	B	AP	AP					
	A	AP	AP					
5ACP + 8S								

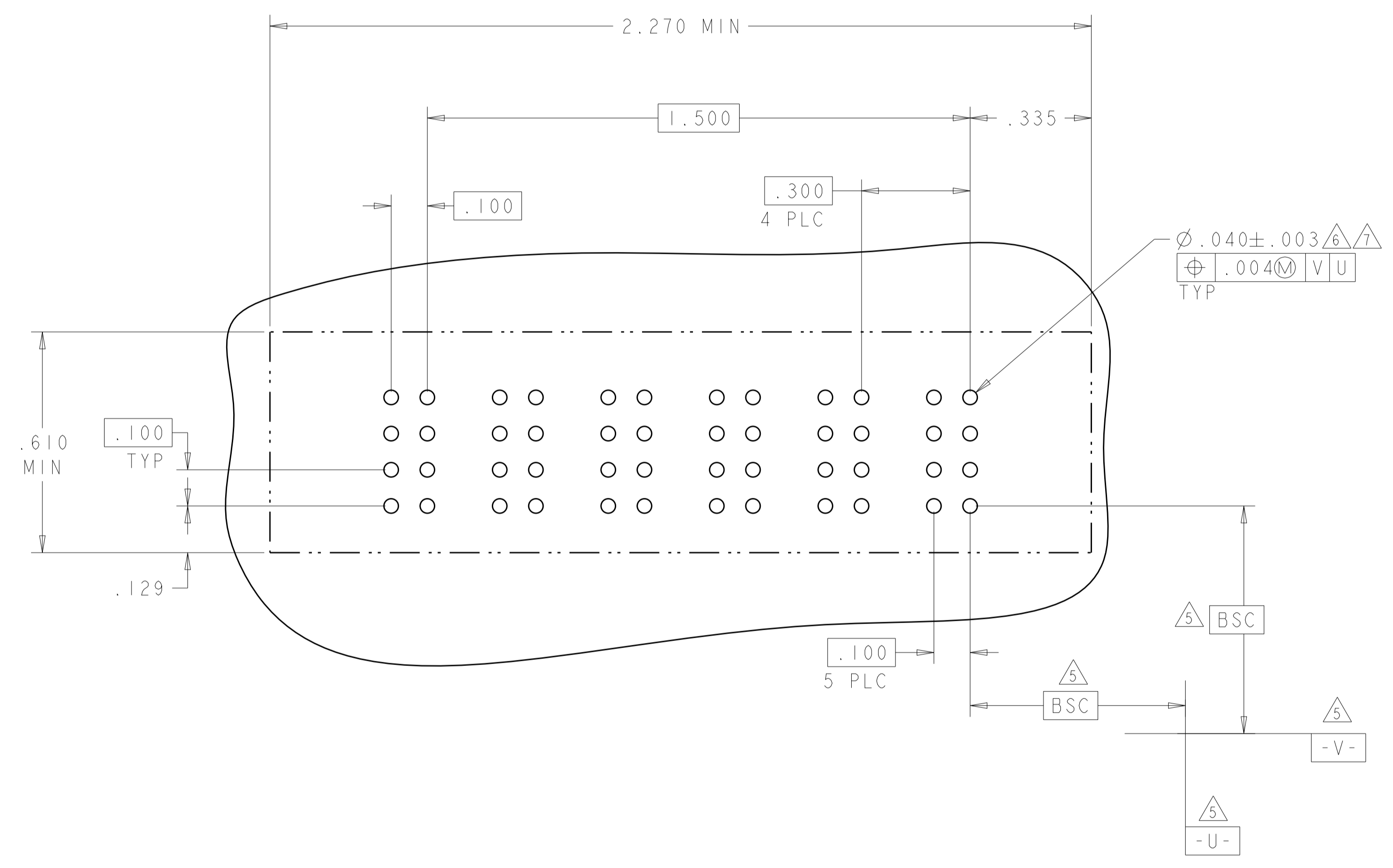

THIS DRAWING IS A CONTROLLED DOCUMENT.		DWN S. ZHAO 18JUN2008	
DIMENSIONS: INCHES		CHK S. ZHAO 18JUN2008	
TOLERANCES UNLESS OTHERWISE SPECIFIED:		APVD S. ZHAO 18JUN2008	
0 PLC ±.1 1 PLC ±.1 2 PLC ±.02 3 PLC ±.005 4 PLC ±.0020 ANGLES ±.2°		PRODUCT SPEC 108-2292 APPLICATION SPEC 114-13251 WEIGHT - CUSTOMER DRAWING	
MATERIAL -		FINISH -	NAME VERTICAL RECEPTACLE W/ P+S MULTI-BEAM XLE SIZE A100779 C=6450862 SCALE 2:1 SHEET 9 OF 9 REV 07

Компания «Океан Электроники» предлагает заключение долгосрочных отношений при поставках импортных электронных компонентов на взаимовыгодных условиях!

Наши преимущества:

- Поставка оригинальных импортных электронных компонентов напрямую с производств Америки, Европы и Азии, а так же с крупнейших складов мира;
- Широкая линейка поставок активных и пассивных импортных электронных компонентов (более 30 млн. наименований);
- Поставка сложных, дефицитных, либо снятых с производства позиций;
- Оперативные сроки поставки под заказ (от 5 рабочих дней);
- Экспресс доставка в любую точку России;
- Помощь Конструкторского Отдела и консультации квалифицированных инженеров;
- Техническая поддержка проекта, помощь в подборе аналогов, поставка прототипов;
- Поставка электронных компонентов под контролем ВП;
- Система менеджмента качества сертифицирована по Международному стандарту ISO 9001;
- При необходимости вся продукция военного и аэрокосмического назначения проходит испытания и сертификацию в лаборатории (по согласованию с заказчиком);
- Поставка специализированных компонентов военного и аэрокосмического уровня качества (Xilinx, Altera, Analog Devices, Intersil, Interpoint, Microsemi, Actel, Aeroflex, Peregrine, VPT, Syfer, Eurofarad, Texas Instruments, MS Kennedy, Miteq, Cobham, E2V, MA-COM, Hittite, Mini-Circuits, General Dynamics и др.);

Компания «Океан Электроники» является официальным дистрибьютором и эксклюзивным представителем в России одного из крупнейших производителей разъемов военного и аэрокосмического назначения «JONHON», а так же официальным дистрибьютором и эксклюзивным представителем в России производителя высокотехнологичных и надежных решений для передачи СВЧ сигналов «FORSTAR».



JONHON

«JONHON» (основан в 1970 г.)

Разъемы специального, военного и аэрокосмического назначения:

(Применяются в военной, авиационной, аэрокосмической, морской, железнодорожной, горно- и нефтедобывающей отраслях промышленности)

«FORSTAR» (основан в 1998 г.)

ВЧ соединители, коаксиальные кабели, кабельные сборки и микроволновые компоненты:

(Применяются в телекоммуникациях гражданского и специального назначения, в средствах связи, РЛС, а так же военной, авиационной и аэрокосмической отраслях промышленности).



Телефон: 8 (812) 309-75-97 (многоканальный)

Факс: 8 (812) 320-03-32

Электронная почта: ocean@oceanchips.ru

Web: <http://oceanchips.ru/>

Адрес: 198099, г. Санкт-Петербург, ул. Калинина, д. 2, корп. 4, лит. А