



Acoustic Interface Design Guide—2010

MEMS MICROPHONES 

SPECIALTY MICROPHONES 

BOOMS AND SENSORS 

ACCELEROMETERS & ACOUSTIC DAMPER SCREENS 

SPECIALTY SPEAKERS 

CUSTOM ASSEMBLIES 

ACOUSTIC SOFTWARE 

MICROPHONE AND SPEAKER BASICS 

Discover your next acoustic interface solution.



Knowles Acoustics offers you a full spectrum of MEMS microphones, specialty microphones, balanced armature speakers, custom assemblies, and sound conditioning software. This application guide will help you select the right acoustic interface solution.

OVER **60** YEARS
acoustic innovation

Knowles reserves the right to change designs and specifications without prior notice. Should a safety concern arise regarding this product, please contact us immediately for technical consultation. Knowles cannot assume responsibility for any problems arising out of the use of this product. This information does not convey any license by any implication under any patents or other right.

We can help you every step of the way.

It all starts with your application. Or it starts with an idea you may have. For support from concept to design to sub-assembly, or any step along the way, just call us. Or visit us at www.knowles.com

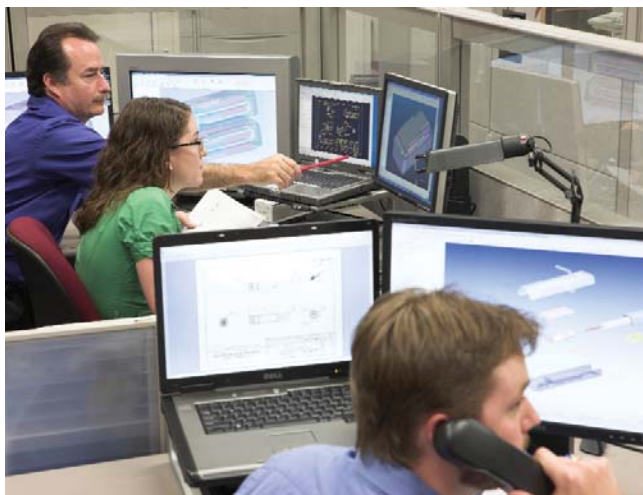

Table of Contents

◎ MICROPHONES - MEMS	4-6
◎ SPECIALTY TRANSDUCERS - MICROPHONES	7-11
◎ SPECIALTY TRANSDUCERS - BOOMS & SENSORS	12-15
◎ ACCELEROMETERS & ACOUSTIC DAMPER SCREENS	16
◎ SPECIALTY TRANSDUCERS - SPEAKERS	17-26
◎ CUSTOM ASSEMBLIES	27
◎ ACOUSTIC SOFTWARE	28
◎ MICROPHONE AND SPEAKER BASICS	29-30

MICROPHONES — MEMS

SiSonic™ MEMS Microphones

Built on our CMOS/MEMS technology platform, the SiSonic™ silicon-based MEMS microphone series is a step ahead of the competition with product shipments exceeding 1 billion units to date. The proven and evolving design series continues to support high-performance, high-density innovation in such applications as cell phones, smart phones, laptop computers, sensors, digital still cameras, portable music players, and other portable electronic devices.

Design variables include ever-smaller sizes, lower profiles and mounting options, increased output capacities, and new digital audio options that eliminate analog noise. For manufacturers, surface mount designs eliminate off-line subassembly production costs. Customized designs are supplied on tape-and-reel and can be run through standard automatic pick-n-place equipment during in-line surface mount manufacturing.

The microphones can also be integrated with our patented IntelliSonic™ software and special porting designs to provide a precisely customized sound.

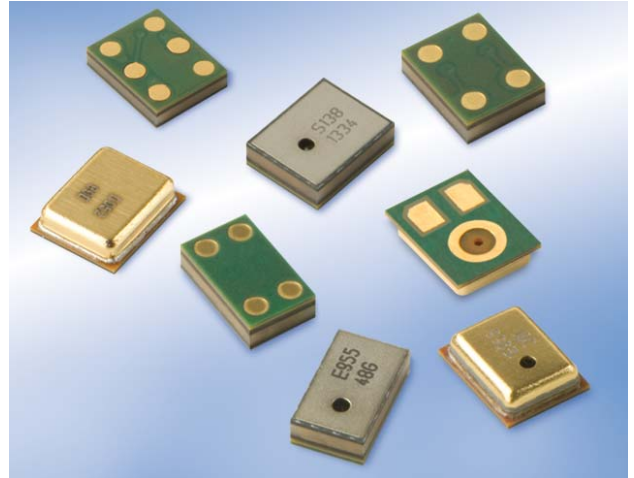

- New MaxRF models eliminate GSM/TDMA burst noise and provide wide-band RF noise suppression
- UltraMini footprint - less than 11.5mm² (SPU Series)
- Slim UltraMini footprint - less than 8.5mm² (SPQ Series)
- Digital mics eliminate analog noise
- Integrated designs with differential or switchable gain
- Zero Height Mic™ for thinnest ever designs

Part Numbering

SPM0404HE5H-PB-6

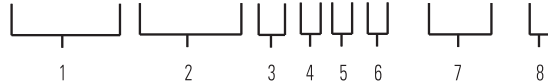

1	2	3	4	5	6	7	8
Product Description	Series	Port Hole Type	RF Filter	Supply Voltage	Halogen Free	Version	Packaging QTY
SPU: Ultra-Mini (3.76 x 2.95)	0404: Unity Gain	H: Top Port	D: Standard	3: 1.5-5.5V		Knowles Internal	Product Specific
SPU: Ultra-Mini (3.76 x 3.00)	0405: Digital	L: Bottom Port	E: Enhanced	4: 1.6-3.6V		(Reference Only)	(Reference Only)
SPM: Mini (4.72 x 3.76)	0406: Differential		R: MAX-RF	5: 1.5-3.6V			
SPQ: Slim Ultra-Mini (3.76 x 2.24)	0407: Switchable Gain						
SPK: (4.00 x 3.00)	0408: Amplified						
	0409: Unity Gain						
	0410: Unity Gain						
	0413: Digital						
	0414: Amplified						

Ultrasonic Acoustic Sensor

Derived from our industry-leading MEMS silicon surface mount microphone technology, our new ultrasonic sensor designs function on a high frequency band. Sensor designs are possible across a wide spectrum of applications requiring highly miniaturized solutions for sensing and actuation/signaling.

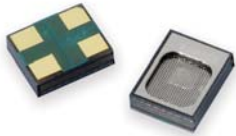

- High frequency functionality
- Wide range of applications
- Micro-sized sensing and actuation

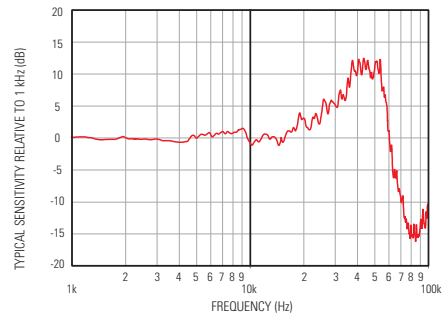

Model	Description	Directivity	Supply Voltage (min-max)	Sensitivity @1kHz (dB re1V/1Pa)	Output Impedance (Ohms)	Maximum Current Drain (mA)
SPM0404UD5	Unity Gain	Omni	1.5 to 3.6v	-42.0	<100	<0.25

Ultra Mini Package

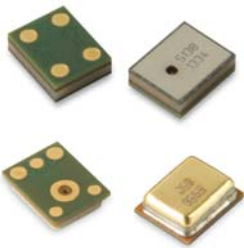

- New Ultra Mini with footprint of 11mm²
- Flexible designs available with/without RF filtering and built in amplifier
- Ideal for miniature consumer electronics

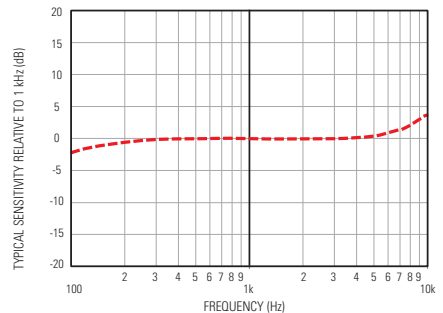

Model	Description	Directivity	Supply Voltage (min-max)	RF Immunity	Sensitivity @1kHz (dB re1V/1Pa)	Output Impedance (Ohms)	Maximum Current Drain (mA)
SPUL409HE5H	Unity Gain	Omni	1.5 to 3.6v	Enhanced	-42.0	<300	<0.25
SPU0409HD5H	Unity Gain	Omni	1.5 to 3.6v	Standard	-42.0	<100	<0.25
SPU0410HR5H	Unity Gain	Omni	1.5 to 3.6v	Max-RF	-42.0	<400	<0.25
SPU0414HR5H	Amplified	Omni	1.5 to 3.6v	Max-RF	-22.0	<400	<0.35

Slim-Ultra Mini Package

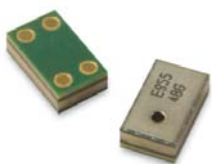

- 24% reduction of footprint (8.4mm²) from the Ultra-Mini Package
- Designs available with/without RF Filtering
- Ideal for miniature consumer electronics

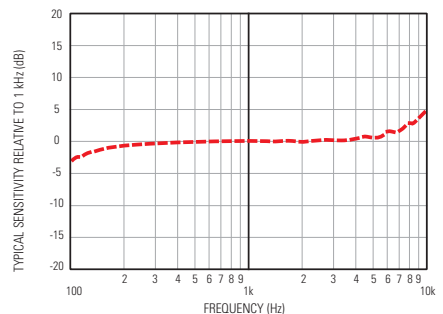

Model	Description	Directivity	Supply Voltage (min-max)	RF Immunity	Sensitivity @1kHz (dB re1V/1Pa)	Output Impedance (Ohms)	Maximum Current Drain (mA)
SPQ0410HE5H	Unity Gain	Omni	1.5 to 3.6v	Enhanced	-42.0	<400	<0.25

MICROPHONES — MEMS

Thin Mini Package

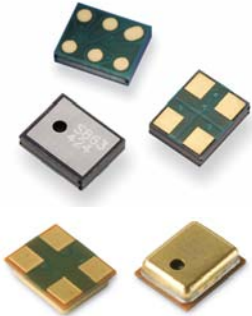

- Thin Mini SiSonic with a footprint less than 18mm² reduces manufacturing costs and brings greater design flexibility
- Rugged, solid-state design process for stable acoustic performance under extreme conditions such as temperature, shock and vibration
- Digital - Pulse Density Modulation (PDM) device available, which has an integrated sleep mode and is compatible with stereo input applications

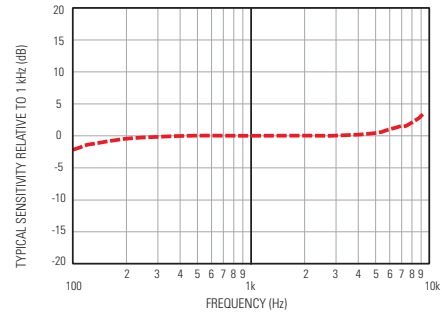

Model	Description	Directivity	Supply Voltage (min-max)	RF Immunity	Sensitivity @1kHz (dB re1V/1Pa)	Output Impedance (Ohms)	Maximum Current Drain (mA)
SPM0404HD5H	Unity Gain	Omni	1.5 to 3.6v	Standard	-42.0	<100	<0.25
SPM0406HE3H	Differential	Omni	1.5 to 5.5v	Enhanced	-22.0	<500	<0.50
SPM0407HE3H	Switchable Gain	Omni	1.5 to 5.5v	Enhanced	-22.0	<300	<0.37
SPM0408HD5H	Amplified	Omni	1.5 to 3.6v	Standard	-22.0	<100	<0.35
SPM0404HE5H	Unity Gain	Omni	1.5 to 3.6v	Enhanced	-42.0	<200	<0.25
SPM0405HD4H	Digital	Omni	1.6 to 3.6v	Digital Standard	-26.0 (dBFS/1Pa)	100pf Maximum Load	<0.60
SPM0408HE5H	Amplified	Omni	1.5 to 3.6v	Enhanced	-22.0	<200	<0.35
SPM0410HR5H	Unity Gain	Omni	1.5 to 3.6v	Max-RF	-42.0	<400	<0.25

Zero Height Mic™ SiSonic

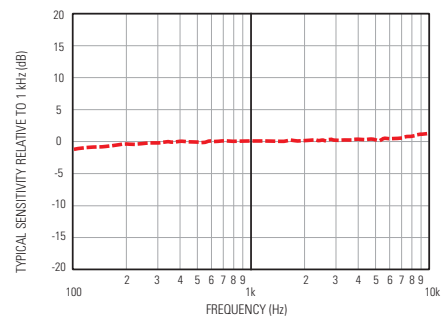
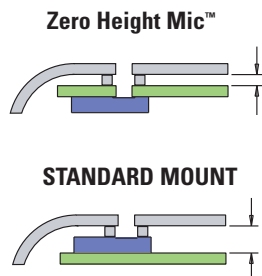
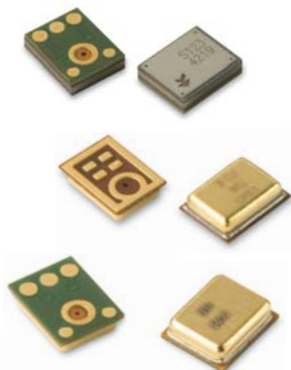

- Zero Height Mic™ SiSonic shrinks product thickness by up to 30%
- Minimizes distance between PCB and mobile device housing
- Ideal for microphone placement on reverse side of PCB, while maintaining acoustic port on top side of mobile device, for clamshell phone designs
- Enables the thinnest, highest density product designs

Model	Description	Directivity	Supply Voltage (min-max)	RF Immunity	Sensitivity @1kHz (dB re1V/1Pa)	Output Impedance (Ohms)	Maximum Current Drain (mA)
SPM0404LE5H	Unity Gain	Omni	1.5 to 3.6v	Enhanced	-38.0	<200	<0.25
SPM0408LE5H	Amplified	Omni	1.5 to 3.6v	Enhanced	-18.0	<200	<0.35
SPM0410LR5H	Unity Gain	Omni	1.5 to 3.6v	Max-RF	-38.0	<400	<0.25
SPU0409LE5H	Unity Gain	Omni	1.5 to 3.6v	Enhanced	-38.0	<200	<0.25
SPU0410LR5H	Unity Gain	Omni	1.5 to 3.6v	Max-RF	-38.0	<400	<0.25
SPK0413LM4H	Digital	Omni	1.6 to 3.6v	Digital Enhanced	-26.0 (dBFS/1Pa)	100pf Maximum Load	<0.65

SPECIALTY TRANSDUCERS — Microphones

Specialty Transducer Microphones

The Specialty Transducer (ST) product line consists of miniature microphones, speakers, and assemblies. Hundreds of design possibilities can be applied to your product challenge with our high-performance microphone designs. Ideal for new product ideas that require premium audio and very small form factors, solutions include noise canceling, omni-directional and unidirectional performance. Other variables include size, shape, amplification, sensitivity, low noise, and resistance to vibration and mechanical shock.

ST components and assemblies are unique in fit, form and function. Our products are designed into high value applications in markets such as the following:

- Communications – headsets, handsets, earpieces, telephony, voice recognition, emergency services, military, surveillance
- Pro audio – in-ear speakers, lapel microphones, boom microphones
- Medical and more – sensors, audiometers, medical implants



GA SERIES – Microphone Omni-Directional 2.00 x 2.00 x 4.00 (mm)

The GA Series Microphone is a brand new microphone design with unique size and shape. Its elongated 2mm x 2mm x 4mm dimensions are ideal for directional applications, allowing you ultimate flexibility in terminal pad area placement. And the GA is using the new '38' circuit providing excellent sensitivity and noise performance for package size. The GA targets space efficiency in BTE and ITE designs; BTE: End-to-end configuration provides 8mm spacing for directionality while ITE: 20% smaller cross sectional area than FG Series.

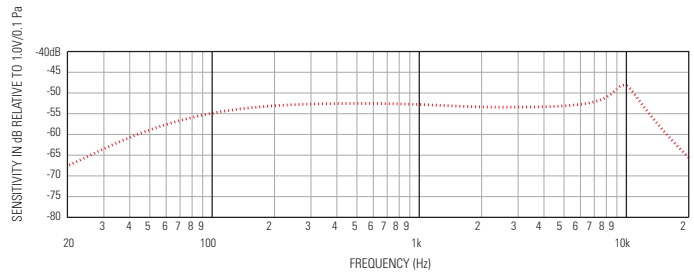

- Compact size providing superior fit rates (2mm x 2mm x 4mm)
- Excellent sensitivity and noise performance for package
- Integral RFI suppression
- Exceptionally low vibration sensitivity
- Multiple acoustic port placement versions

Model	Sensitivity @ 1kHz (dB re1V/0.1Pa)	DC Supply (Vdc)	Max. Amplifier Current Drain (uA)	Max. "A" Weighted Noise (1 kHz Equivalent SPL)	Nominal Output Impedance (Ohms)	Comments
GA38-30774-000	-53.0±3	1.3 nom. 1.6 max	25	24.0 dB	4400	Tubeless, Port on Bottom, Terminal Pads on Cover
GA38-30775-000	-53.0±3	1.3 nom. 1.6 max	25	25.0 dB	4400	Tubeless, Port on End, Terminal Pads on End
GA38-30776-000	-53.0±3	1.3 nom. 1.6 max	25	25.0 dB	4400	Tube Version (0.8mm x 0.74mm ID), Terminal Pads on End

SPECIALTY TRANSDUCERS — Microphones

FG/DFG SERIES – Microphone

Omni-Directional (FG), Directional (DFG) 2.56 DIA x 2.56 (mm)

The FG Series microphone is the world's smallest electret condenser microphone. Its cylindrical shape and compact size facilitate compact designs. The FG can also be used in directional applications as a matched omni-directional pair.



- Smallest microphone option
- High resistance to mechanical shock
- Exceptionally low vibration sensitivity
- Various responses available
- Integral RFI suppression

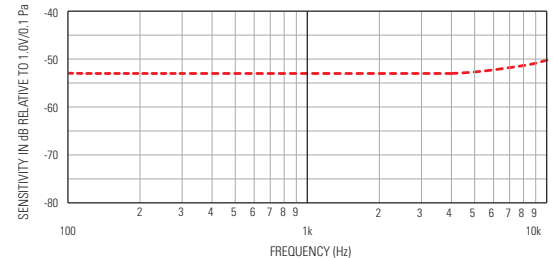

Model	Sensitivity @ 1kHz (dB re1V/0.1Pa)	DC Supply (Vdc)	Max. Amplifier Current Drain (uA)	"A" Weighted Noise * 1kHz Equivalent SPL ** re 1Vrms	Nominal Output Impedance (Ohms)	Comments
FG-23329-D65	-53.0±3	1.3 nom. 3.0 max	50	30.0 dB*	4400	RFI Improved Version
FG-23329-P07	-53.0±3	1.3 nom. 3.0 max	50	30.0 dB*	4400	3-Wire, 1015mm Shielded Cable
FG-23629-P16	-53.0±3	1.3 nom. 3.0 max	50	28.0 dB*	4400	3-Wire, 25.4mm Litz Wires
FG-23629-D65	-53.0±3	1.3 nom. 3.0 max	50	28.0 dB*	4400	RFI Improved Version
FG-23652-D65	-53.0±3	1.3 nom. 3.0 max	50	28.0 dB*	4400	RFI Improved Version
FG-23652-P16	-53.0±3	1.3 nom. 3.0 max	50	28.0 dB*	4400	3-Wire, 25.4mm Litz Wires
FG-23742-D36	-63.0±3	1.3 nom. 3.0 max	50	36.0 dB*	4400	3-Wire, 25.4mm Litz Wires
FG-26163-D65	-58.0±3	1.3 nom. 3.0 max	50	-93.0 dB**	4400	RFI Improved Version 6dB/Octave Ski-Slope
DFG-30344-000	-67.0±3	1.3 nom. 3.0 max	50	-93.0 dB**	700	Directional, Super Cardioid
DFG-30852-000	-69.0±3	1.3 nom. 3.0 max	50	-93.0 dB**	1700	Directional, Cardioid
DFG-30851-000	-73.0±3	1.3 nom. 3.0 max	50	-93.0 dB**	1700	Directional, Noise Canceling

EM SERIES – Microphone

Omni-Directional 3.63 x 3.63 x 2.28 (mm)

The EM is a popular, alternative omni-directional microphone. The EM can also be used in directional applications as a matched omni-directional pair.



- High resistance to mechanical shock
- Improved RFI and EMI
- Undamped, screen damped, and internally damped responses
- Numerous port locations
- Wide range of frequency responses

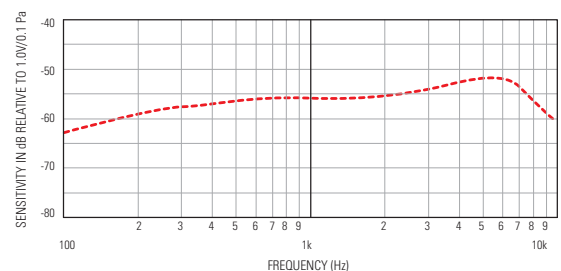

Model	Sensitivity @ 1kHz (dB re1V/0.1Pa)	DC Supply (Vdc)	Max. Amplifier Current Drain (uA)	"A" Weighted Noise * 1kHz Equivalent SPL ** re 1Vrms	Nominal Output Impedance (Ohms)	Comments
EM-23046-P16	-56.0±3	1.3 nom. 3.0 max	50	31.0 dB*	4400	3-Wire, 25.4mm Litz Wire Standard Response
EM-23069-000	-56.0±3	1.3 nom. 1.6 max	50	33.0 dB*	4400	Tubeless Standard Response
EM-30081-D65	-68.0±3	1.3 nom. 3.0 max	50	-98.0 dB**	4400	12dB/Octave Ski-Slope

SPECIALTY TRANSDUCERS — Microphones

EK/EL SERIES – Microphone

Omni-Directional (EK), Unidirectional (EL) 4.00 x 5.59 x 2.28 (mm)

EK omnidirectional microphones provide a unique combination of size, performance and value. Its high electroacoustic sensitivity and low noise make this microphone an excellent choice for applications where space allows. These popular microphones are available in many model varieties.



- High resistance to mechanical shock
- Available with RFI suppression
- Various port locations available
- Wide range of frequency responses
- High S/N performance

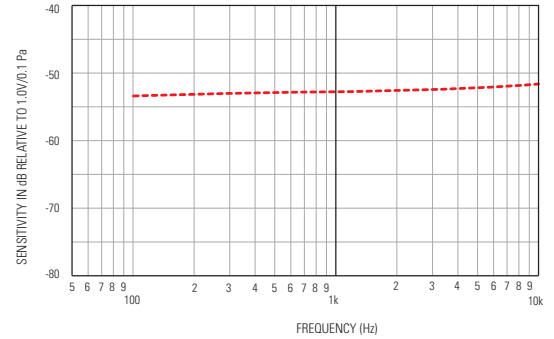

Model	Sensitivity @ 1kHz (dB re1V/0.1Pa)	DC Supply (Vdc)	Max. Amplifier Current Drain (uA)	"A" Weighted Noise * 1kHz Equivalent SPL ** re 1Vrms	Nominal Output Impedance (Ohms)	Comments
EK-23024-C36	-53.0±2	1.3 nom. 10 max	50	26.0 dB*	4400	RFI Improved Version Standard Response
EK-23024-P07	-53.0±2	1.3 nom. 10 max	50	26.0 dB*	4400	3-Wire, 1 m Shielded Cable Standard Response
EK-23027-C36	-53.0±2	1.3 nom. 10 max	50	26.0 dB*	4400	RFI Improved Version Standard Response
EK-23028-C36	-57.0±3	1.3 nom. 10 max	50	-100.0 dB**	4400	RFI Improved Version 6dB/Octave Ski-Slope
EK-23033-C36	-53.0±2	1.3 nom. 10 max	50	26.0 dB*	4400	RFI Improved Version Broadband Response
EK-23132-000	-53.0±2	1.3 nom. 10 max	50	26.0 dB*	4400	Broadband Response
EK-23133-C36	-53.0±2	1.3 nom. 10 max	50	26.0 dB*	4400	RFI Improved Version Broadband Response
EK-23142-C37	-53.0±2	1.3 nom. 10 max	50	26.0 dB*	4400	RFI Improved Version Broadband Response
EL-23078-000	-53.0±2	1.3 nom. 10 max	50	-100.0 dB**	4400	Dual Port Uni-Directional

NR SERIES – Microphone

Noise Canceling 4.00 x 5.59 x 2.28 (mm)

The NR Series close talking microphones deliver state-of-the-art noise canceling performance. NR microphones are used as headset microphones in the most demanding communication and speech recognition environments. The NR Series microphones are available in boom microphone packages. (See the Specialty Transducers - Booms & Sensors section for details.)



- Integral FET amplifier
- Diaphragm responds to pressure differential giving high rejection of background noise
- Withstands severe environmental conditions
- Low vibration sensitivity
- High electroacoustical sensitivity
- Superior noise canceling performance
- Lead attachment available

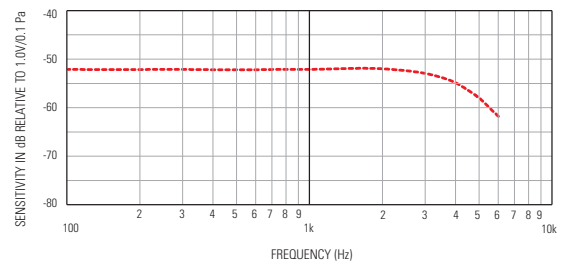

Model	Sensitivity @ 1kHz (dB re1V/0.1Pa)	DC Supply (Vdc)	Max. Amplifier Current Drain (uA)	Max. "A" Weighted Noise (dBV)	Nominal Output Impedance (Ohms)	Comments
NR-23158-000	-49.0±3	1.3 nom. 10 max	50	-100	4400	3-Wire
NR-23159-000	-65.0±3	1.3 nom. 10 max	200	-100	2500	2-Wire
NR-23160-000	-52.0±3	1.3 nom. 10 max	200	-100	2500	2-Wire
NR-25994-000	-49.0±3	1.3 nom. 10 max	50	-100	4400	3-Wire
NR-25994-D63	-55.0±4	1.3 nom. 10 max	300	-100	2000	2-Wire
NR-30610-D63	-59.0±3	3.0 nom. 10 max	550	-100	2000	2-Wire

SPECIALTY TRANSDUCERS — Microphones

BJ SERIES – Microphone

Omni-Directional, Noise Canceling 7.87 x 5.59 x 4.01 (mm)

Knowles' Magnetic Microphones (BJ Series) are based on balanced armature technology and are self-shielded against external magnetic fields. The microphones offer high efficiency, stability, and reliability and are small in size. The diaphragm of the BJ Series responds to pressure differential, giving high rejection of background noise. Both face and edge ports are offered. In addition, there is a short distance between front and back ports resulting in improved noise rejection up to higher frequencies.



- *Balanced armature technology*
- *High efficiency, stability and reliability*
- *Self-shielded against external magnetic fields*
- *Face and edge ports*
- *Diaphragm responds to pressure differential giving high rejection of background noise*
- *Short distance between front and back ports resulting in improved noise rejection up to higher frequencies*

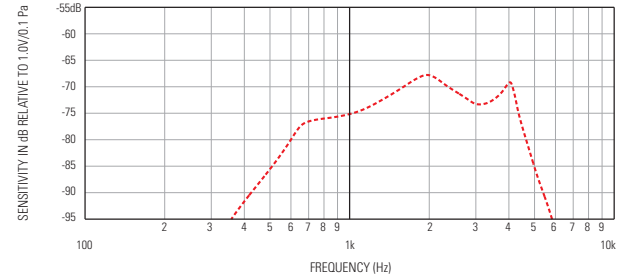

Model	Directivity	Port Location	Nominal Impedance at 1kHz (Ohms)	Nominal DC Resistance at 20° C (Ohms)
BJ-21590-000	Omni-Directional	OJn	3900	900
BJ-28411-000	Noise Canceling	Dual	300	75.5

BL SERIES – Omni-Directional Microphone

Knowles' Piezo Ceramic Microphones (BL Series) are rugged, stable and versatile. BL microphones are available in three different package sizes: standard, thin or 0.5" cylindrical shell and cable assembly. Both communication and broadband frequency response versions are offered. In addition, BL microphones have high vibration sensitivity and may be used as accelerometers.



- *High sensitivity*
- *Wide frequency range*
- *Integral FET amplifier*
- *High resistance to mechanical shock*
- *Various responses*
- *Two case sizes available*

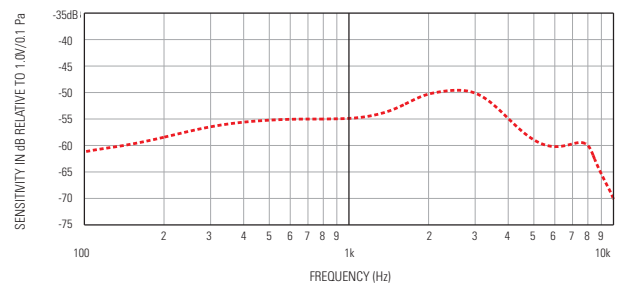

Model	Dimensions (mm)	Sensitivity @ 1kHz (dB re1V/0.1Pa)	DC Supply (Vdc)	Max. Amplifier Current Drain (uA)	"A" Weighted Noise	Nominal Output Impedance (Ohms)	Comments
BL-21671-000	7.87 x 5.54 x 4.06	-54.0±3	1.3	50	32.0 dB	13000	Standard Response
BL-21671-140	7.87 x 5.84 x 4.06	-54.0±4	1.3	50	32.0 dB	13000	Faster Overpressure Recovery Standard Response
BL-21785-000	7.87 x 5.54 x 2.24	-69.0±3	3	160	34.0 dB	4000	Broadband Response
BL-21994-000	25.5	-69.0±3	3	160	34.0 dB	4000	965mm Shielded Cable Broadband Response
BL-23497-000	25.5	-69.0±3	3	160	34.0 dB	4000	34.3mm Leads Broadband Response
BL-27046-000	7.87 x 5.54 x 2.24	-69.0±3	1.3	160	34.0 dB	4000	Broadband Response

SPECIALTY TRANSDUCERS — Microphones

WP SERIES – Waterproof Microphone

Omni-Directional, Noise Canceling 3.99 x 5.56 x 2.21 (mm)

The WP Series' form factor is a very small size with low vibration sensitivity. The excellent noise canceling performance is useful for sensors and instrumentation. The WP Series are available in boom microphone packages. (See the FB Series and PNR/PWP Series for details.)



- Waterproof to submersion in 1m water
- Close-talking (noise-canceling)
- Corrosion resistant
- Withstands explosive decompression
- Excellent environmental performance
- High resistance to mechanical shock

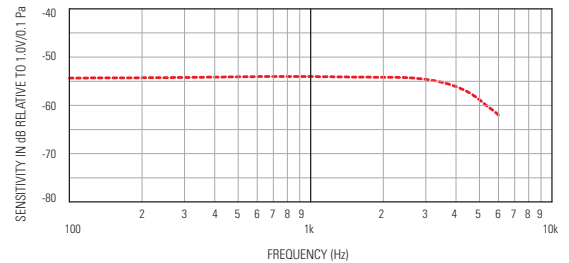

Model	Sensitivity @ 1kHz (dB re1V/0.1Pa)	Directivity	DC Supply (Vdc)	Max. Amplifier Current Drain (uA)	"A" Weighted Noise * 1kHz Equivalent SPL ** re 1Vrms	Nominal Output Impedance (Ohms)	Comments
WP-23501-000	-54.0±3	Noise Canceling	1.3 nom. 10 max	300	-100 dB**	2500	2-Wire
WP-23502-000	-52.0±3	Omni-Directional	1.3 nom. 10 max	50	26.0 dB*	4400	3-Wire
WP-23502-P07	-52.0±3	Omni-Directional	1.3 nom. 10 max	50	26.0 dB*	4400	3-Wire, w/ 1m Shielded Cable
WP-23502-P16	-52.0±3	Omni-Directional	1.3 nom. 10 max	50	26.0 dB*	4400	3-Wire, w/ 25.4mm Litz Wires
WP-23849-C36	-52.0±3	Omni-Directional	1.3 nom. 10 max	50	26.0 dB*	4400	3-Wire, RFI Improved + Extended Response
WP-25993-D63	-55.0±4	Noise Canceling	1.3 nom. 10 max	300	-100 dB**	2000	2-Wire

MR SERIES – Waterproof Microphone

Omni-Directional

The MR Series Assemblies consist of a microphone element attached to a bellows assembly. They may be panel mounted, attached for boom applications, and are suitable for outdoor use or repeated submersion.



- Highly waterproof – no loss of performance after immersion in 15-20 m water
- Corrosion resistant
- Withstands explosive decompression
- Design proven in rugged environments
- Cable wire attached
- High resistance to mechanical shock
- Acoustically transparent bellows
- Resists effects of mud, sand, and salt encrustation

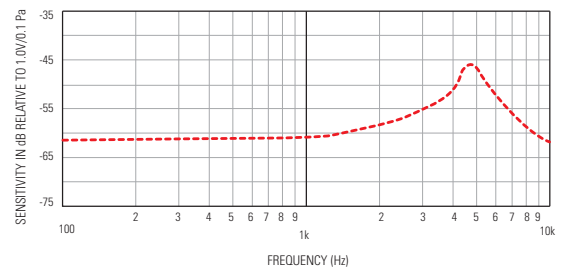

Model	Dimensions (mm)	Sensitivity @ 1kHz (dB re1V/0.1Pa)	DC Supply (Vdc)	Max. Amplifier Current Drain (uA)	"A" Weighted Noise	Nominal Output Impedance (Ohms)	Comments
MR-23151-000	22.12 DIA x 9.3	-87.0±3	N/A	N/A	30.0 dB	300	2-Wire, 193mm Leads
MR-23793-000	22.12 DIA x 11.43	-60.0±4	1.3	100	31.0 dB	2500	3-Wire, 201mm Leads
MR-28406-000	22.12 DIA x 7.6	-60.0±3	1.3	50	30.0 dB	3500	3-Wire, 202mm Leads

SPECIALTY TRANSDUCERS — Booms & Sensors

Booms & Sensors

Knowles' boom microphones are designed for either flexible or rigid configurations and offer such performance options as noise rejection and high-frequency crossover of near and far field responses. Lengths and end terminations are customized to meet your application needs. Marketers of headsets and audio systems often seek Knowles boom designs. Collaboration with commercial, governmental and industrial designers is producing new helmet applications for aircraft, military, first responder and high-noise manufacturing environments.

- Standard and waterproof
- Flexible and rigid styles
- Boom housing available in plastic and metal
- Customized lengths and end terminations



Part Numbering

FB-F I -30026-000



1
Product Description
FB: Flexible Boom

2
Boom Diameter
A: 2.3mm OD Positionable Cable
B: 2.7mm OD Gooseneck (w/shrink tube)
D: 4.2mm OD Gooseneck (w/shrink tube)
E: 5.4mm OD Gooseneck (w/shrink tube)
F: 5.9mm OD Gooseneck (w/shrink tube)
H: 5.0mm OD Gooseneck (w/shrink tube)
M: 1.0mm OD Positionable Tube

3
Head Series
I: BJ Housing
M: NR/WP Waterproof Housing
O: Original Housing
U: FG/DFG Micro Housing
W: Plastic Housing w/ Sinter Disc

4
Model #
Knowles Internal
Reference Only

VWP-F-30109-000



1
Product Description
V: Value Added

2
Element Series
EK, EA, WP

3
Housing Series
B: Over Molded
C: Custom Design
F: Plastic Fixed Housing
H: ESD Shielded Plastic

4
Model #
Knowles Internal
Reference Only

SPECIALTY TRANSDUCERS — Booms & Sensors

I SERIES



- Designed for military customers who are looking for a noise canceling non-power element in robust platform with waterproofing options from 1m down to 10m (based on IP67 rating)
 - Also available in Omni-Directional
 - Meets MIL-STD-810F standards
- Plastic head design with metal flexible boom
 - Available in 5.9mm down to 4.2mm diameter metal flexible boom
- Military forces, Special Operations, Security and Police and other military communication headsets
 - Mounted and un-mounted ground forces, armor units
- Designed for the BJ series elements

Model	*Rating	Microphone Element	Directivity	Boom Length Tip-To-Tip (mm)	Exit Wire Length (mm)	Nominal Boom Diameter (mm)	Microphone Configuration
FB-EI-30026-000	1m	BJ-28471-000 (150Ω Impedance)	Noise Canceling	172	60	5.4	2-Wire
FB-EI-30426-000	1m	BJ-28486-000 (30Ω Impedance)	Noise Canceling	172	60	5.4	2-Wire

*Rating done to IP67 test criteria

M SERIES



- Designed for military customers who are looking for a noise canceling electret element in robust waterproof housing
 - Available in Omni-Directional
 - Waterproof options from 1m down to 20m (per IP67, IP68 and MIL-STD-810F)
- Plastic head design with metal flexible boom
 - Available in 6.0mm down to 2.7mm diameter metal flexible boom
- Military forces, Special Operations, Security, Fire and Police and other high end communication headsets
 - Over the ear, earcup or helmet designs for mounted and non-mounted ground forces
- Designed for EK, NR and WP series elements

Model	*Rating	†Microphone Element	Directivity	Boom Length Tip-To-Tip (mm)	Exit Wire Length (mm)	Nominal Boom Diameter (mm)	Microphone Configuration
FB-EM-30342-000	1m	NR-25994-D63	Noise Canceling	167	60	5.4	2-Wire
FB-EM-30343-000	3m	WP-25993-D63	Noise Canceling	167	60	5.4	2-Wire
FB-EM-30344-000	10m	NR-25994-D63	Noise Canceling	167	60	5.4	2-Wire
FB-EM-30345-000	20m	NR-25994-D63	Noise Canceling	167	60	5.4	2-Wire
FB-EM-30346-000	1m	EK-23132-C36	Omni-Directional	167	60	5.4	2-Wire
FB-EM-30348-000	10m	EK-23132-C36	Omni-Directional	167	60	5.4	2-Wire
FB-EM-30349-000	20m	EK-23132-C36	Omni-Directional	167	60	5.4	2-Wire

*Rating done to IP67 test criteria † WP-Series elements are waterproof

SPECIALTY TRANSDUCERS — Booms & Sensors

U SERIES



- Designed for Pro-Audio and performance customers who are looking for the lightest directional microphone in an ultra slim housing
- Available in Uni-Directional design
- Metal head design with metal position-able boom
- New 1.0mm diameter design available in multiple colors (flesh tones, black, tan, brown, etc...)
- News Anchors, Referees, professional presenters, performance artists and other high-end communication headsets
- In-ear ultra light design
- Designed for the DFG, VFG & FG elements series

Model	Rating	Microphone Element	Directivity	Boom Length Tip-To-Tip (mm)	Exit Wire Length (mm)	Nominal Boom Diameter (mm)	Microphone Configuration
FB-MU-30774-000	IP51	DFG-30445-000	Uni-Directional (Super-Cardioid)	115	18	1.0	2-Wire
FB-MU-31024-000	IP51	DFG-30851-000	Noise Canceling	115	18	1.0	2-Wire
FB-MU-31025-000	IP57	VFG-30747-000	Omni-Directional	115	18	1.0	2-Wire

W SERIES



- Designed for customers who are looking for small footprint and lightweight platform with waterproofing to 1m (based on IP67 rating)
- Plastic head design with metal flexible boom
- Available in 4.2mm down to 2.7mm diameter metal flexible boom
- Security, Police, Fire dispatchers and other lightweight communication headsets
- SWAT, SRT, HRT, Bike Patrol, Motorcycle Patrol, Mounted and Marine Patrol, K9 Officer
- Designed for the NR and WP elements, but can also accommodate EK and EA series

Model	*Rating	†Microphone Element	Directivity	Boom Length Tip-To-Tip (mm)	Exit Wire Length (mm)	Nominal Boom Diameter (mm)	Microphone Configuration
FB-DW-30294-000	3m	WP-25993-D63	Noise Canceling	140	60	4.2	2-Wire
FB-BW-30335-000	3m	WP-25993-D63	Noise Canceling	160	60	2.7	2-Wire
FB-DW-30296-000	3m	WP-25993-000	Noise Canceling	140	60	4.2	3-Wire
FB-DW-30293-000	IP54 ‡	NR-25994-D63	Noise Canceling	140	60	4.2	2-Wire
FB-BW-30330-000	IP54 ‡	NR-25994-D63	Noise Canceling	160	60	2.7	2-Wire
FB-DW-30295-000	IP54 ‡	NR-25994-000	Noise Canceling	140	60	4.2	3-Wire

*Rating done to IP67 test criteria † WP-Series elements are waterproof ‡ Splashproof meeting IP54 test criteria

O SERIES



- Designed for military customers who are looking for a noise canceling electret element in a metal EMI shielded housing
- Available in Omni-Directional
- Waterproof options down to 3m using WP elements
- Metal head design with metal flexible boom
- Available in 8.0mm down to 4.2mm diameter metal flexible boom
- Military forces, Special Operations, Security, Fire and Police and other communication headsets
- Over the ear, earcup or helmet designs for mounted and non-mounted ground forces
- Designed for the EK, NR and WP elements series

Model	*Rating	†Microphone Element	Directivity	Boom Length Tip-To-Tip (mm)	Exit Wire Length (mm)	Nominal Boom Diameter (mm)	Microphone Configuration
FB-DO-23511-000	3m	WP-23501-000	Noise Canceling	142	150	4.2	2-Wire
FB-DO-25946-000	3m	WP-23501-000	Noise Canceling	54	30	4.2	2-Wire
FB-HO-25624-000	3m	WP-23501-000	Noise Canceling	142	160	5.0	2-Wire
FB-FO-25581-000	N/A	EK-23024-000	Omni-Directional	104	140	5.9	2-Wire

*Rating done to IP67 test criteria † WP-Series elements are waterproof

SPECIALTY TRANSDUCERS — Booms & Sensors

F SERIES



- Designed for ruggedized panel mounted applications for outdoor microphone and sensor applications
 - Available in Omni Directional
 - Waterproof options from 1m down to 20m (per IP67, IP68 and MIL-STD-810F)
- Police and Military forces, Special Operations, personalized shot detection systems
 - Sensor arrays for vibration acoustic signatures and triangulation systems
- Designed for the EK, NR and WP elements series

Model	*Rating	Microphone Element	Directivity	Exit Wire Length (mm)	Sensor Diameter (mm)	Microphone Configuration
VEK-F-30350-000	1m	EK-23132-C36	Omni-Directional	200	16	3-Wire
VEK-F-30351-000	10m	EK-23132-C36	Omni-Directional	200	16	3-Wire
VEK-F-30352-000	20m	EK-23132-C36	Omni-Directional	20	16	3-Wire
VEK-F-30460-000	1m	EK-23132-C36	Omni-Directional	10	16	3-Wire
VEK-F-30300-000	20m	EK-23132-C36	Omni-Directional	8	16	3-Wire
VEK-F-30470-000	1m	EK-26899-P58	Omni-Directional	174 (Shielded)	16	3-Wire

*Rating done to IP67 test criteria

H SERIES



- Designed for ruggedized fixed position and mounted applications for outdoor sensor arrays for vibration, acoustic signatures and triangulation systems
 - Available in Omni Directional
 - Waterproof options from 1m down to 20m (per IP67, IP68 and MIL-STD-810F)
- Conductive plastic housing designed to pass MIL-STD-810F EMI shielding housing with shielded cable assembly
 - Available with extra high SPL circuit design
 - Custom PCBA options available within the housing cavity
- Military, homeland security, border patrol, Police and local municipality applications
 - Electronic fence, ground sensor / vibration sensor technology, human, light and heavy armored vehicle, helicopter sensors
- Designed for EK, NR, GH and WP series elements

Model	*Rating	†Microphone Element	Directivity	Sensor Length (mm)	Sensor Diameter (mm)	Exit Wire Length (mm)	Microphone Configuration
VWP-H-30109-000	3m	WP-30113-P03	Omni-Directional	21	12.7	211	3-Wire
VEK-H-30320-000	1m	EK-23169-P03	Omni-Directional	21	12.7	211	3-Wire
VEK-H-30108-000	1m	EK-26899-P03	Omni-Directional	21	12.7	211	3-Wire

*Rating done to IP67 test criteria † WP-Series elements are waterproof

SPECIALTY TRANSDUCERS — Accelerometers & Acoustic Dampers

BU SERIES – Accelerometer 7.87 x 5.54 (mm)

BU Series Accelerometers are frequently used as contact microphones for radio communications in high noise environments such as firefighting or combat. The accelerometers reproduce voice signals from vibrations at the throat or from bony parts of the head, and are compatible with helmet or headset applications.



- Ceramic vibration transducer
- High vibration sensitivity
- Small size
- Wide frequency range
- Integral FET amplifier
- High resistance to mechanical shock
- Withstands severe environmental conditions

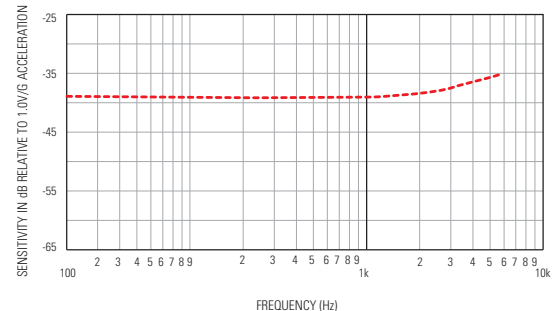

Model	Thickness	Sensitivity @ 1KHz (dB re 1V/g)	DC Supply (V)	Max. Current Drain (uA)	Nominal Output Impedance @1 KHz (Ohms)	"A" Weighted Noise (dBre. 1V)
BU-21771-000	4.06	-45.0±4.5	1.5	50	5200	-103
BU-23173-000	4.06	-39.0±4.5	1.5	50	5200	-103
BU-23842-000	2.24	-40.0±4.0	1.5	50	5200	-103
BU-27135-000	2.24	-45.0±4.5	1.5	300	5200	-103

BF Series – Acoustic Damper Screens

Dampers are acoustic cloth screens for insertion inside acoustic tubing. These damping elements are used between the speaker outlet and the ear canal to smoothen the frequency response.



- Smoothen and shape frequency response
- Various acoustical resistances and sizes

Model	Color	Nominal Acoustic Resistance (Ohms)	PLUG (mm)	SCREEN (mm)
BF-1859-000	White	680	2.08	--
BF-1860-000	Brown	1000	2.08	--
BF-1861-000	Green	1500	2.08	--
BF-1921-000	Red	2200	2.08	--
BF-1922-000	Orange	3300	2.08	--
BF-1923-000	Yellow	4700	2.08	--
BF-1988-000	White	680	--	1.12
BF-1991-000	Green	1500	--	1.12
BF-1995-000	Red	2200	--	1.12
BF-1997-000	White	680	--	1.78
BF-1999-000	Grey	330	2.08	--
BF-3034-000	Grey	330	--	1.78
BF-3035-000	Brown	1000	--	1.78
BF-3036-000	Orange	3300	--	1.78
BF-3037-000	Red	2200	--	1.78
BF-3038-000	Green	1500	--	1.78
BF-3039-000	Green	1500	--	1.37
BF-3163-000	Yellow	4700	--	1.12

SPECIALTY TRANSDUCERS — Speakers

Specialty Transducer Speakers

Knowles sub-miniature speaker designs are based on balanced armature technology (BAX) and are utilized in a variety of high performance audio and communication products. Knowles balanced armature speakers are available in several sizes and efficiencies, which can be finely tuned to meet your specific performance requirements. They are designed for use in in-ear applications, including earphones and communication earpieces, or be sub-assembled by Knowles for premium consumer electronics accessories.

- High efficiency, stability and reliability
- Customizable performance and port locations
- Ideal for premium in-ear designs
- Component and subassembly solutions



TWFK SERIES – Dual Balanced Armature Speaker 5.00 x 2.73 x 3.86 (mm)

The world's smallest dual balanced armature speaker, the TWFK is designed for pro-audio in-ear applications. Enables customized cross-over systems to achieve target frequency response in a package size smaller than the ED Series.



- Single sound port for simplified earphone design
- Extreme wideband frequency response
- Unique woofer/tweeter combination
- Enables leading-edge earphone designs for miniature size and performance

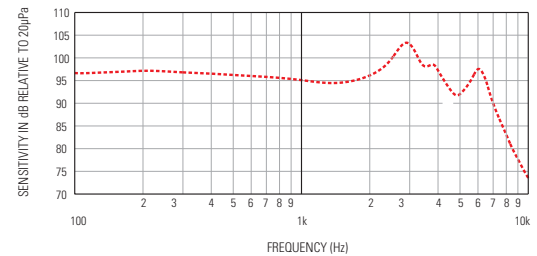

Model	Port Location	Sensitivity @ 1 kHz (dB SPL)	Sensitivity @ 1st Peak (dB SPL)	Max SPL @ 1st Peak (dB SPL)	DC Resistance (Ohms)	Impedance @ 500 Hz (Ohms)
TWFK-30017-000	12S	95	103	113	25	31

FK/DFK SERIES – Balanced Armature Speaker 5.00 x 2.73 x 1.93 (mm) (FK), 5.00 X 2.73 X 3.86 (mm) (DFK)

The world's smallest balanced-armature speaker, the FK Series is designed for applications where size is the most important design concern.



- Two-terminal zero-bias configuration
- Undamped, screen damped, and internally damped responses
- Wide range of coil impedances
- DFK model is a dual FK

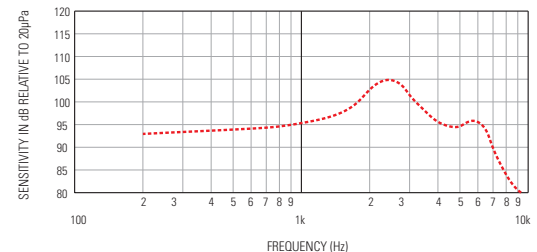

Model	Port Location	Sensitivity @ 1 kHz (dB SPL)	Sensitivity @ 1st Peak (dB SPL)	Max SPL @ 1st Peak (dB SPL)	DC Resistance (Ohms)	Impedance @ 500 Hz (Ohms)
FK-23451-000	12S	95.5	108.5	118.5	360	450
FK-23466-000	12S	95.5	108.5	118.5	360	450
FK-26260-000	12S	96	105	115.5	135	180
DFK-30041-000	12S	99.7	105.5	115.5	100	133

SPECIALTY TRANSDUCERS — Speakers

WBFK SERIES – Wideband Balanced Armature Speaker 5.00 x 2.73 x 1.93 (mm)

Same package size as FK Series, WBFK has extended high frequency response. It is recommended as a high frequency component to be combined with low/midrange speaker for music earphones.



- Lower low/mid-band sensitivity compared to FK Series
- Best high frequency response of any Knowles element
- Combine with low/mid-range speaker for extended frequency response
- TWFK pairs WBFK with low frequency FK

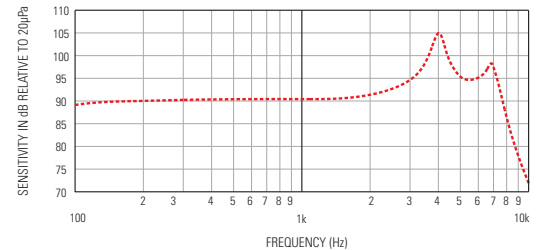

Model	Port Location	Sensitivity @ 1 kHz (dB SPL)	Sensitivity @ 1st Peak (dB SPL)	Max SPL @ 1st Peak (dB SPL)	DC Resistance (Ohms)	Impedance @ 500 Hz (Ohms)
WBFK-30000-000	12S	95	105	114	100	111
WBFK-30095-000	12S	91	105	114	12.5	13.5

FH SERIES – Balanced Armature Speaker 5.09 x 2.80 x 2.59 (mm)

The FH speaker represents an unprecedented combination of ultra-compact size and high SPL output with efficiencies normally found only in much larger speakers. The FH speaker line brings true high-gain, high-output performance to earphone designs.



- Undamped, screen damped, internally damped, and Ferrofluid™ damped responses
- Various port locations, coil impedances, damping options, termination configurations, and frequency responses available
- Maximum SPL output of 123dB at resonance peak, 109dB at midband (500Hz)*

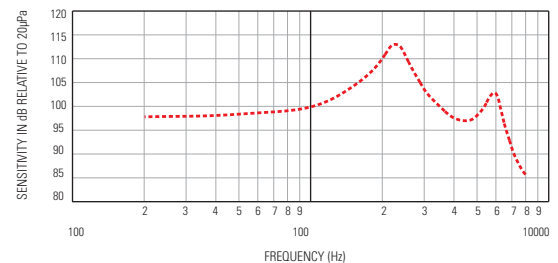

Model	Port Location	Sensitivity @ 1 kHz (dB SPL)	Sensitivity @ 1st Peak (dB SPL)	Max SPL @ 1st Peak (dB SPL)	DC Resistance (Ohms)	Impedance @ 500 Hz (Ohms)
FH-23371-000	12S	100	113	123	60	90
FH-23375-000	12S	100	113	123	240	335
FH-23377-000	12S	100	113	123	515	685
FH-23821-000	12S	100	113	123	125	174
FH-26553-000	12S	100	113	123	60	90

SPECIALTY TRANSDUCERS — Speakers

HC SERIES – Balanced Armature Speaker 5.16 x 3.51 x 3.00 (mm)

Knowles balanced-armature, magnetic technology to give high efficiency, stability and reliability. HC Series provides increased low frequency dynamic range in a package size equal to FC.



- High-output technology provides double (+3dB) the maximum acoustic output of existing Knowles FC Series speakers
- Maximum output comparable to Knowles' ED Series speaker in a package size only 68% as large!
- Same size and dimensions as Knowles' EH Series
- Ideal for applications where small size and high output is required

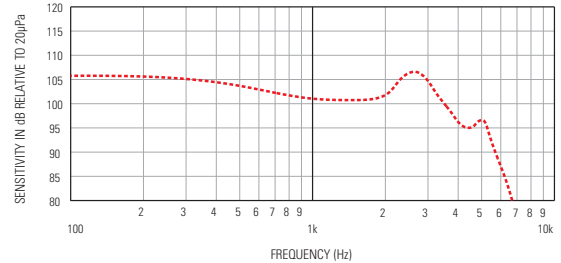

Model	Port Location	Sensitivity @ 1 kHz (dB SPL)	Sensitivity @ 1st Peak (dB SPL)	Max SPL @ 1st Peak (dB SPL)	DC Resistance (Ohms)	Impedance @ 500 Hz (Ohms)
HC-23761-000	12C	101	107	116	4.9	8.4
HC-23763-000	12C	101	107	116	11.5	20
HC-23764-000	12C	101	107	116	15.5	24

WBHC SERIES – Balanced Armature Speaker 5.16 x 3.51 x 3.00 (mm)

The advanced design of the HC Series speaker provides extended acoustic bandwidth for hi-fi in-ear speakers when paired with a low frequency speaker.



- Lower low/mid band sensitivity compared to HC series
- Combine with low/mid-range speaker for extended frequency response

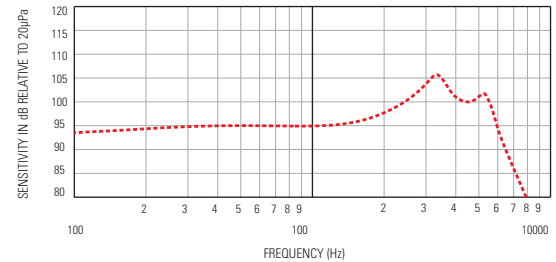

Model	Port Location	Sensitivity @ 1 kHz (dB SPL)	Sensitivity @ 1st Peak (dB SPL)	Max SPL @ 1st Peak (dB SPL)	DC Resistance (Ohms)	Impedance @ 500 Hz (Ohms)
WBHC-23910-000	12C	95	106	115	120	130

FC SERIES – Balanced Armature Speaker 5.18 x 3.55 x 3.00 (mm)

FC Series speakers may be used for small radio communication earphones where ED size does meet package requirements. Rounded corners make it slightly smaller compared to EH Series speakers.



- Available in High-Output HC speaker version
- Two-terminal zero-bias and three-terminal center-tapped configurations
- Undamped, screen damped, internally damped, and Ferrofluid™ damped responses
- Rounded corners for improved fit rates; 10% smaller cross-section compared to EH speaker

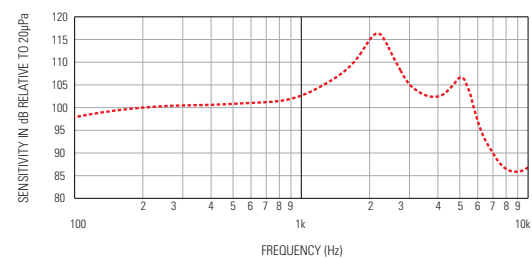

Model	Port Location	Sensitivity @ 1 kHz (dB SPL)	Sensitivity @ 1st Peak (dB SPL)	Max SPL @ 1st Peak (dB SPL)	DC Resistance (Ohms)	Impedance @ 500 Hz (Ohms)
FC-26171-000	12C	104	117	127	135	170
FC-26465-000	12C	104	117	127	42	57
FC-26654-000	12C	104	113	123	40	60
FC-26887-000	12C	100	105	116	354	425

SPECIALTY TRANSDUCERS — Speakers

EH SERIES – Balanced Armature Speaker 5.19 x 3.55 x 3.00 (mm)

EH Series speakers are approximately 2/3 the size of ED speakers and may be used for small radio communication earphones where ED size does not meet package requirements.



- *Balanced-armature, magnetic technology to give high efficiency, stability and reliability*
- *High sensitivity*
- *Various responses, including standard, damped and modified*
- *Low distortion*
- *Self-shielded for low magnetic radiation*

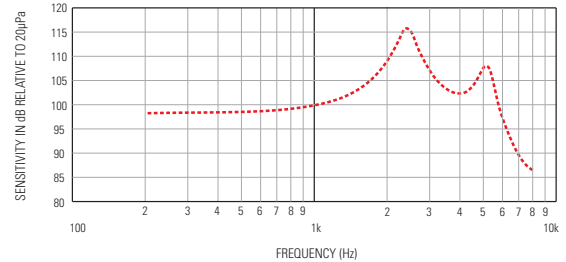

Model	Port Location	Sensitivity @ 1 kHz (dB SPL)	Sensitivity @ 1st Peak (dB SPL)	Max SPL @ 1st Peak (dB SPL)	DC Resistance (Ohms)	Impedance @ 500 Hz (Ohms)
EH-23030-000	12C	100	117	126.5	395	625
EH-23149-000	12C	100	116	126.5	68	101
EH-27479-000	12C	100	112.5	123	118	144

ES SERIES – Balanced Armature Amplified Speaker 5.18 x 3.54 x 3.04 (mm)

EH size speaker with integrated Class D power amplifier.



- *EH micro speaker, but with internal, highly-efficient, class D amplifier*
- *Lower current drain prolongs battery life*
- *Lower distortion*
- *Available in a range of SPL ratings*

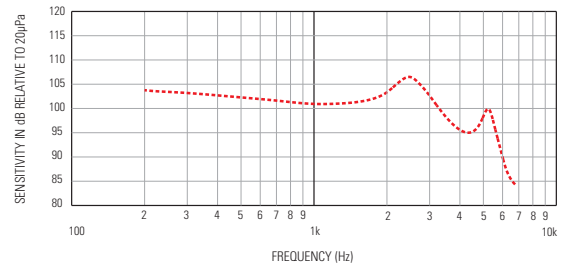

Model	Port Location	Sensitivity @ 1 kHz (dB SPL)	Sensitivity @ 1st Peak (dB SPL)	Max SPL @ 1st Peak (dB SPL)
ES-23127-000	12C	101	107	117.5
ES-23140-000	12C	101	105.5	115.5

GQ SERIES – Two-Way Balanced Armature Speaker 6.30 x 4.29 x 4.92 (mm)

The GQ is a two-way balanced armature system with added low frequency headroom, designed for pro-audio in-ear application. Enables customized cross-over response to achieve target frequency response.



- *Dual element with enhanced bass capabilities and wideband response*
- *Unique, subminiature woofer/tweeter combination for in-ear applications*
- *Single port for simplified earphone design*

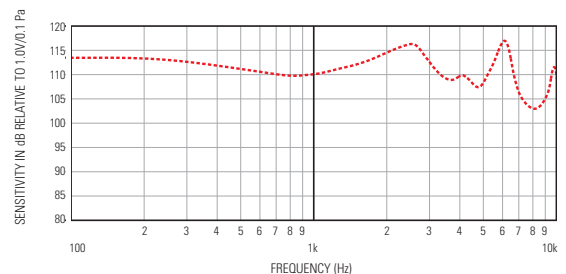

Model	Port Location	Sensitivity @ 1 kHz (dB SPL)	Sensitivity @ 1st Peak (dB SPL)	Max SPL @ 1st Peak (dB SPL)	DCR	Impedance @ 500 Hz (Ohms)
GQ-30783-000	12S	109.5	116	126	12.5	21.5

SPECIALTY TRANSDUCERS — Speakers

ED SERIES – Balanced Armature Speaker 6.32 x 4.31 x 2.97 (mm)

One of Knowles' most versatile and most popular speakers, its compact size and appreciable output power make the ED speaker suitable for a variety of instruments.



- Undamped, screen damped, internally damped, and Ferrofluid™ damped responses
- Numerous port locations and coil impedances
- High efficiency and low distortion

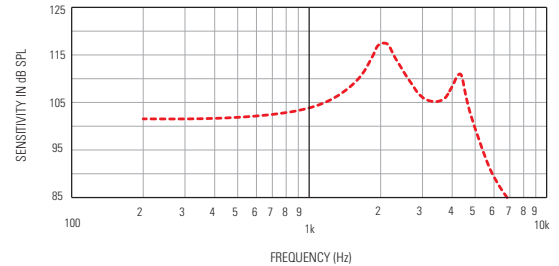

Model	Port Location	Sensitivity @ 1 kHz (dB SPL)	Sensitivity @ 1st Peak (dB SPL)	Max SPL @ 1st Peak (dB SPL)	DC Resistance (Ohms)	Impedance @ 500 Hz (Ohms)
ED-21744-000	12C	104	112.5	123	825	1700
ED-21913-000	12C	104	117.5	127	376	780
ED-23147-000	12C	102.5	110	120.5	25	48
ED-23619-000	12C	104	117.5	127	3.3	7.1
ED-23801-000	12C	104	113	122	155	196
ED-23814-000	12C	104	112.5	128	23	50
ED-26245-000	12C	104	113	122	35	55
ED-26598-000	12C	102.5	106	115.5	196	395
ED-26821-000	12C	102.5	111	120.5	3.3	7.1
ED-27045-000	9C	104	113	127	196	395
ED-27230-000	12C	104	117.5	127	54.5	79
ED-27304-000	12C	104	117	127	201	290
ED-29689-000	12C	104	118	127	3.7	7.1
ED-26805-000	12C	102	110	120	23	26
ED-26876-000	12C	102.5	111	121	25	48

FED SERIES – Balanced Armature Speaker 6.32 x 4.31 x 2.47 (mm)

The addition of *Ferrofluid™* to Knowles ED series speakers improves mechanical shock survival and provides peak damping to smooth frequency response.



- Ferrofluid™ damped with 2dB, 4dB, or 6dB peak amplitude
- Superior shock performance and reduced speaker vibration
- Two-terminal zero-bias and three-terminal center-tapped configurations
- Numerous port locations and coil impedances

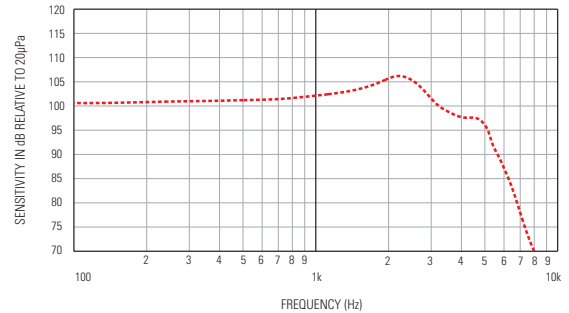

Model	Port Location	Sensitivity @ 1 kHz (dB SPL)	Sensitivity @ 1st Peak (dB SPL)	Max SPL @ 1st Peak (dB SPL)	DC Resistance (Ohms)	Impedance @ 500 Hz (Ohms)
FED-26792-I04	12C	102.5	107	116.5	48	65
FED-30048-I04	12N	102	107	116	23	26

SPECIALTY TRANSDUCERS — Speakers

EP SERIES – Balanced Armature Amplified Speaker 6.32 x 4.29 x 2.99 (mm)

Based on Knowles' versatile and popular ED speaker, the EP series adds the benefits of an internal Class-D amplifier. Its compact size and appreciable output power make the EP speaker suitable for a variety of designs.



- Class D amplified magnetic speaker
- Self-shielded to reduce magnetic radiation
- 125dB SPL maximum output
- Three-terminal electrical connection

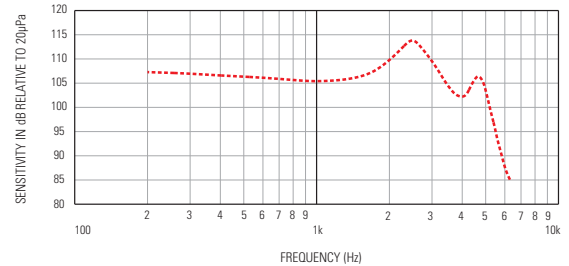

Model	Port Location	Sensitivity @ 1 kHz (dB SPL)	Sensitivity @ 1st Peak (dB SPL)	Max SPL @ 1st Peak (dB SPL)
EP-24075-000	12C	106	114	124

SR SERIES – Balanced Armature Speaker 6.40 DIA x 4.00 (mm)

At 6.4mm diameter, the Mini SR is the smallest round balanced armature speaker in the marketplace. SR offers output equivalent to the FC series and maximizes bass performance.



- Round package facilitates earphone designs
- Drop-in upgrade for moving coil dynamic speakers
- Designed for high volume production
- Balanced armature technology

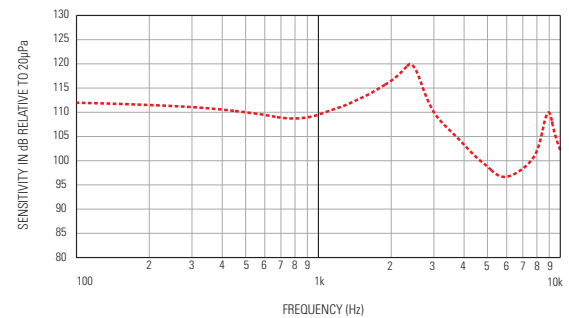

Model	Port Location	Sensitivity @ 1 kHz (dB SPL)	Sensitivity @ 1st Peak (dB SPL)	Max SPL @ 1st Peak (dB SPL)	DC Resistance (Ohms)	Impedance @ 500 Hz (Ohms)
SR-6438NWS-000	Face	109.5	120	130	25	36.5
SR-6438NWS-158	Face	109.5	120	130	25	32.8

EC SERIES – Balanced Armature Speaker 7.57 x 4.31 x 3.67 (mm)

EC Series speakers are commonly used in isolating earphones for radio communication.



- Similar SPL output to the BK Series
- Rounded corners on the face opposite the terminal pad
- 34% smaller volume than the BK Series

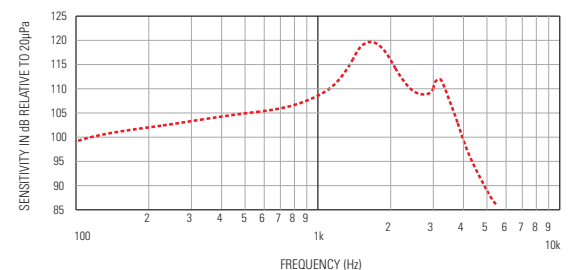

Model	Port Location	Sensitivity @ 1 kHz (dB SPL)	Sensitivity @ 1st Peak (dB SPL)	Max SPL @ 1st Peak (dB SPL)	DC Resistance (Ohms)	Impedance @ 500 Hz (Ohms)
EC-23097-000	12S	108	120	130	92	200
EC-23098-000	12S	108	120	130	196	425
EC-26368-000	12S	108	120	129	26.3	54

SPECIALTY TRANSDUCERS — Speakers

TEC SERIES – Balanced Armature Speaker 7.87 x 4.09 x 2.79 (mm)

The TEC combines output comparable to the larger BK speaker in an ultra-thin package. The TEC is suitable for multi-element earphone designs.



- Ultra-thin
- Wideband output
- DTEC combines two TEC elements
- Enables small multi-element designs

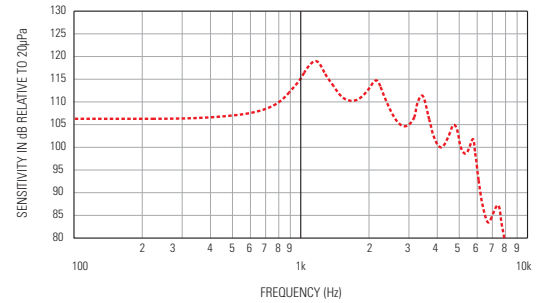

Model	Port Location	Sensitivity @ 1 kHz (dB SPL)	Sensitivity @ 1st Peak (dB SPL)	Max SPL @ 1st Peak (dB SPL)	DC Resistance (Ohms)	Impedance @ 500 Hz (Ohms)
TEC-30033-000	12C	115	119	129	22	31
TEC-30087-000	12C	115	119	129	46	62

DTEC SERIES – Balanced Armature Speaker 7.87 x 4.09 x 5.59 (mm)

The DTEC Series combines two TEC speaker elements with a single round port. Case size is equivalent to BK/EF. DTEC provides increased output and reduced vibration compared to a single speaker.



- Dual elements with single sound port
- More output than BK in equal package size
- Reduced vibration compared to BK
- Improved frequency response compared to BK

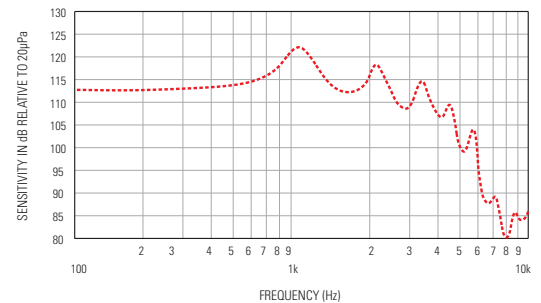

Model	Port Location	Sensitivity @ 1 kHz (dB SPL)	Sensitivity @ 1st Peak (dB SPL)	Max SPL @ 1st Peak (dB SPL)	DC Resistance (Ohms)	Impedance @ 500 Hz (Ohms)
DTEC-30008-000	12S	123	122.5	132.5	23	31.5

SPECIALTY TRANSDUCERS — Speakers

BK SERIES – Balanced Armature Speaker 7.87 x 5.59 x 4.01 (mm)

BK Series speakers provide broadband performance at value pricing. They are commonly used for full range in-ear speakers and communications utilizing an earplug design.



- High efficiency and low distortion
- Various port locations, coil impedances, damping options, terminal configurations, and frequency responses available

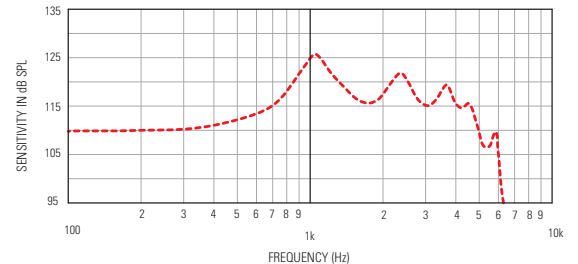

Model	Port Location	Sensitivity @ 1 kHz (dB SPL)	Sensitivity @ 1st Peak (dB SPL)	Max SPL @ 1st Peak (dB SPL)	DC Resistance (Ohms)	Impedance @ 500 Hz (Ohms)
BK-21600-000	12S	123	125	133	100	285
BK-21604-000	12S	123	125	133	895	2320
BK-21610-000	12S	121	126	136	21	60
BK-21613-000	1S	118	125	134	160	450
BK-21615-000	12S	118	125	134	160	450
BK-21669-000	12C	123.5	125	134	9	22
BK-23134-000	12S	118	125	134	100	285
BK-26824-000	12S	119	120	129	10.7	16
BK-28507-000	12S	126	126	136	10.7	13.3
BK-28510-000	12S	123	127	135	111	320
BK-28562-000	12S	123	124	131	18.5	23
BK-29725-000	12S	118	119	128	100	285

GP SERIES – Two-Way Balanced Armature Speaker 7.90 x 4.29 x 5.76 (mm)

The GP is a two-way balanced armature system with high output capabilities for professional in-ear applications. Enables customized cross-over response to achieve target frequency response.



- High performance, low-profile two-way system
- Customizable cross-over capabilities
- Dual ported to mechanically tune each driver

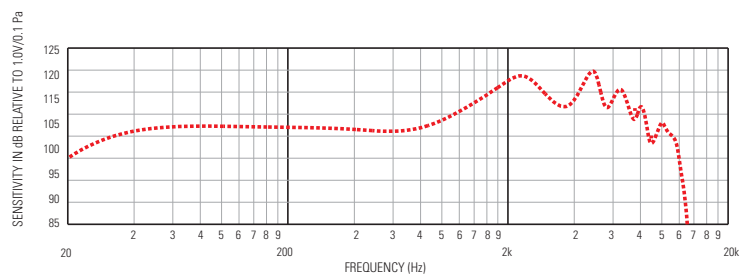

Model	Port Location	Sensitivity @ 1 kHz (dB SPL)	Sensitivity @ 1st Peak (dB SPL)	Max SPL @ 1st Peak (dB SPL)	DC Resistance (Ohms)	Impedance @ 500 Hz (Ohms)
GP-30711-000	12S (Dual)	108.5	118	128	58	67

SPECIALTY TRANSDUCERS — Speakers

CI SERIES – Balanced Armature Speaker 9.47 x 7.18 x 4.10 (mm)

Knowles' largest and most powerful speaker, the CI series is the speaker of choice. With its high efficiency and a 143dB SPL maximum output, the CI speaker provides optimal low frequency performance.



- Two-terminal zero-bias and three-terminal center-tapped configurations
- Various port locations, coil impedances, termination configurations, and frequency responses available

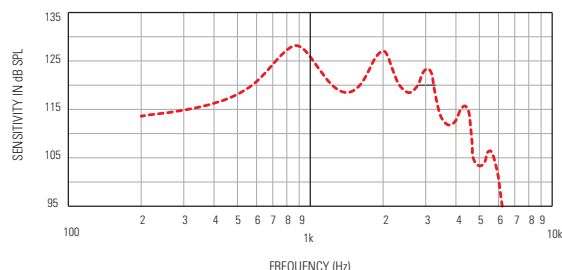

Model	Port Location	Sensitivity @ 1 kHz (dB SPL)	Sensitivity @ 1st Peak (dB SPL)	Max SPL @ 1st Peak (dB SPL)	DC Resistance (Ohms)	Impedance @ 500 Hz (Ohms)
CI-22748-000	12C	125	128	138.5	75	250
CI-22762-000	1S	125	128	138.5	51	175
CI-22955-000	12C	125	128	138.5	20	68 @ 1kHz
CI-22960-000	12C	125	128	138.5	100	400
CI-28487-000	1S	125	128	138.5	24	100 @ 1kHz
CI-28597-000	11S	125	128	138.5	20	68 @ 1kHz

CM SERIES – Balanced Armature Speaker 8.38 x 16.64 DIA (mm)

The CM Series delivers the benefits of balanced armature technology in a compact finished package. The CM is ideal for use in situations where a non-contacting headset is required, but signal voltage is limited – as is common for radios and wireless telephones. The CM also conserves battery power, and provides static shock protection for the user.



- Balanced-armature, magnetic technology to give high efficiency, stability and reliability
- High acoustic efficiency enables sufficient sound output even when limited power is available
- In-built static protection
- Lightweight, matt-black, plastic housing
- Ergonomically designed with rounded edge to fit the concha
- High-quality sound output
- Tailored bandwidth for superb speech intelligibility

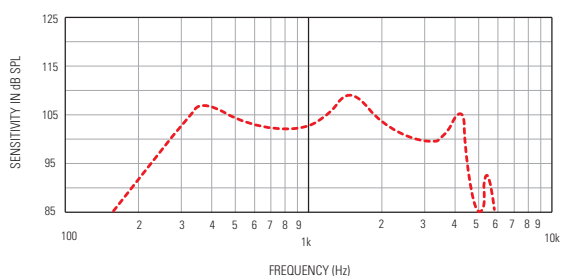

Model	Port Location	Sensitivity @ 1 kHz (dB SPL)	Sensitivity @ 1st Peak (dB SPL)	Max SPL @ 1st Peak (dB SPL)	DC Resistance (Ohms)	Impedance @ 500 Hz (Ohms)
CM-23152-000	Face	103	109	119	69	150
CM-23299-000	Face	103	109	119	69	150
CM-28421-000	Face	103	109	119	100	360
CM-28431-000	Face	103	109	119	10.5	30
CM-28452-000	Face	103	109	119	100	360

SPECIALTY TRANSDUCERS — Speakers

MR SERIES – Waterproof Speaker 22.12 DIA x 9.3 (mm)

The MR Series Assemblies consist of a speaker element attached to a waterproof bellows assembly. They may be panel mounted, and are suitable for outdoor use or repeated submersion.



- Highly waterproof – no loss of performance after immersion in 15m water
- Corrosion resistant
- Withstands explosive decompression
- Design proven in rugged environments
- Leads attached
- High resistance to mechanical shock
- Acoustically transparent bellows
- Resists effects of mud, sand, and salt encrustation

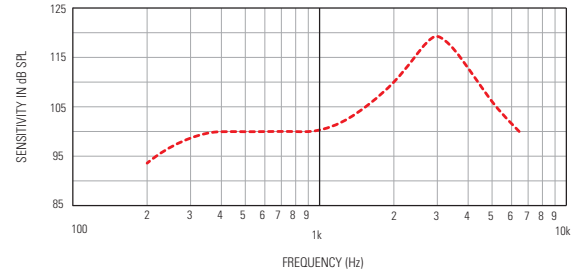

Model	Port Location	Sensitivity @ 1 kHz (dB SPL)	Sensitivity @ 1st Peak (dB SPL)	Max SPL @ 1st Peak (dB SPL)	DC Resistance (Ohms)	Impedance @ 500 Hz (Ohms)
MR-23333-000	Face	100	119.5	129	10	21

CB SERIES – Balanced Armature Speaker 25.15 x 25.15 x 9.65 (mm)

The CB Series Transceiver offers high electro-acoustic efficiency to conserve power in push-to-talk radio handsets and other battery operated equipment. The CB is available with mounting pins to facilitate assembly to a PC board. Model CB-23817-000 is designed to survive submersion in water.



- Excellent sound quality
- High speech intelligibility, stability, and reliability
- Suitable for PCB mounting
- Can function as a microphone or beeper
- Various impedances
- Face and edge port locations available

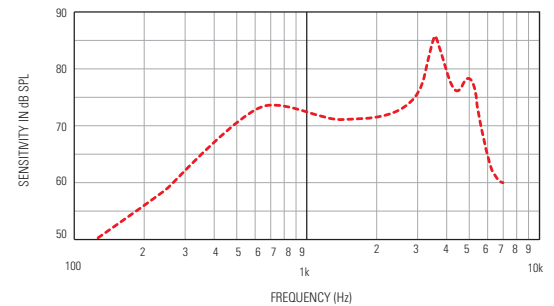

Model	Port Location	Sensitivity @ 1 kHz (dB SPL)	Sensitivity @ 1st Peak (dB SPL)	Max SPL @ 1st Peak (dB SPL)	DC Resistance (Ohms)	Impedance @ 500 Hz (Ohms)
CB-22849-000	Edge	73	86	96.5	11.5	24
CB-22850-000	Edge	73	86	96.5	21.5	48
CB-23817-000	Edge	83	97	107	21.5	48

CUSTOM ASSEMBLIES

FINISHED GOODS

Wherever your design ideas take you, Knowles Acoustics can support your need for customized audio assemblies. Our custom Finished Goods offer a turnkey solution utilizing the acoustic expertise and components of Knowles Acoustics.



COMPLETE SOLUTION

Knowles Acoustics Finished Goods program offers reduced time to market at an ultimately reduced total manufacturing cost of acoustic product ownership. Support in design, application, assembly and testing are all elements included in our services. Off-the-shelf designs are also available.

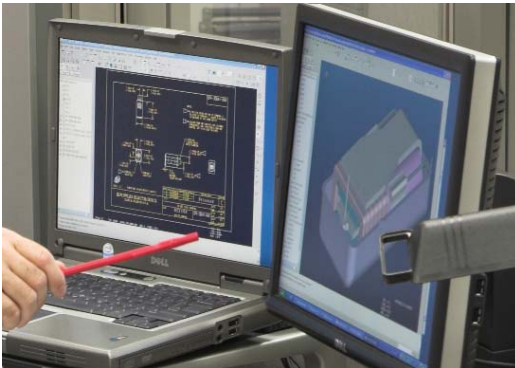

- Design Support
- Industrial
 - Mechanical
 - Application Tuning



- Manufacturing Services
- Assembly
 - Cabling
 - Testing
 - Utilization of Knowles Acoustic components

MARKET APPLICATIONS

Ultimately, our mission is to improve the acoustic interface and simplify the manufacturing process for customers. Our long term acoustic history provides the expertise for markets and customers of:

- Mobile media products
- Industrial communications
- Consumer electronics applications

MARKET MATRIX

Assembly Designs	MP3	Mobile Phone	Smart Phone/PDA	Notebook	Industrial Comm.
Single Ear		✓	✓		✓
Stereo	✓	✓	✓	✓	✓
Microphone		✓	✓	✓	✓

Collaborate in-depth with Knowles Acoustics to arrive at an integrated component and assembly design to manufacture for you.

ACOUSTIC SOFTWARE

INTELLISONIC™

The intelligibility and use of mobile communications are often impeded by the impact of noise from the immediate environment. IntelliSonic is a software-based speech enhancement technology that when coupled with Knowles' microphones, reduces the effects of reverberation, directionally interfering speech, background noise and annoying acoustic echo.

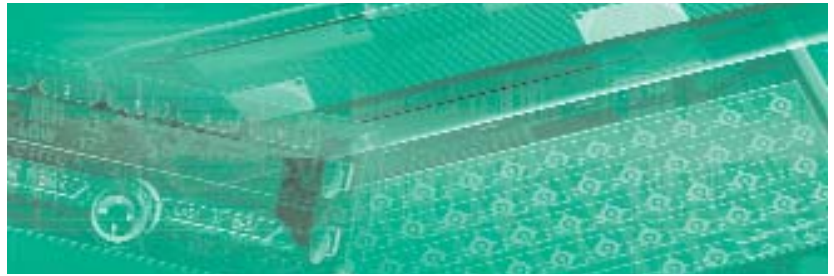

COMPLETE SOLUTION – Integrated Systems

When you consider the interdependency of microphone design, acoustic porting, and sound signal conditioning, it's easy to see why Knowles Acoustics has taken an integrated approach to your acoustic system needs.

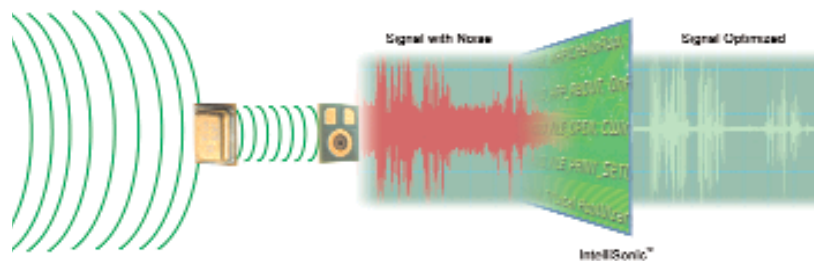

FEATURES

- Noise suppression 12dB-16dB
- Interference cancellation via beam-forming array 25dB
- Acoustic echo cancellation 25dB
- Speech bandwidth 8kHz
- Adjustable acceptance and look angles
- Fully adaptive system adapts to changing acoustic environment
- Rich application programming interface (API) set
- Real-time processing
- Low speech distortion

APPLICATIONS

Platforms such as tablets, laptops, ultra-mobile personal computers (UPCs), and other mobile computing devices have a number of applications that would benefit from IntelliSonic to enhance the user experience and final product perception.

- VoIP Telephony
- Command and Control
- Voice recognition
- Dictation
- Language Translation
- Voice Annotation
- Audio Note Taking

PRODUCT MATRIX

Product Code	# of Microphones	Noise Reduction	Array Processing	Echo Cancellation
DXEC01	1	✓	–	✓
DXEC02	2	✓	✓	✓



(Visual output of recordings using same microphone)

SUPPORTED PLATFORMS (OS Support)

OS	Model	Codec
Microsoft Windows XP/2000	WDM Upper Filter	AC'97 and HDAudio
Microsoft Windows 7/Vista	WaveRT APO	AC'97, HDAudio and USBAudio
Microsoft Windows Mobile and its Derivatives	Static library or integrated into codec driver binary (requires customization)	

LICENSING

Evaluation licenses are available upon signing an NDA and Software Evaluation Agreement. Volume Licensing is available for OEM products. Please contact Knowles Sales Representatives for terms.

MICROPHONE AND SPEAKER BASICS

MICROPHONES

Microphones measure sound pressure. Inside a Knowles microphone is a thin flexible diaphragm, an electrically charged plate, and an amplifier (Fig. 1). The output voltage is proportional to changes in the small separation between the diaphragm and the charged plate (Fig. 2).

As sound pressure inside the front cavity increases, the diaphragm is pushed closer to the plate. As the pressure decreases, it moves further away. The motion of the diaphragm produces a small electrical signal that is amplified by a miniature circuit inside the microphone.

The sensitivity of a typical Knowles' microphone is measured in units of dB relative to 1 Volt per 0.1 Pascal.

Fig 1: Cross section of a Knowles EM microphone

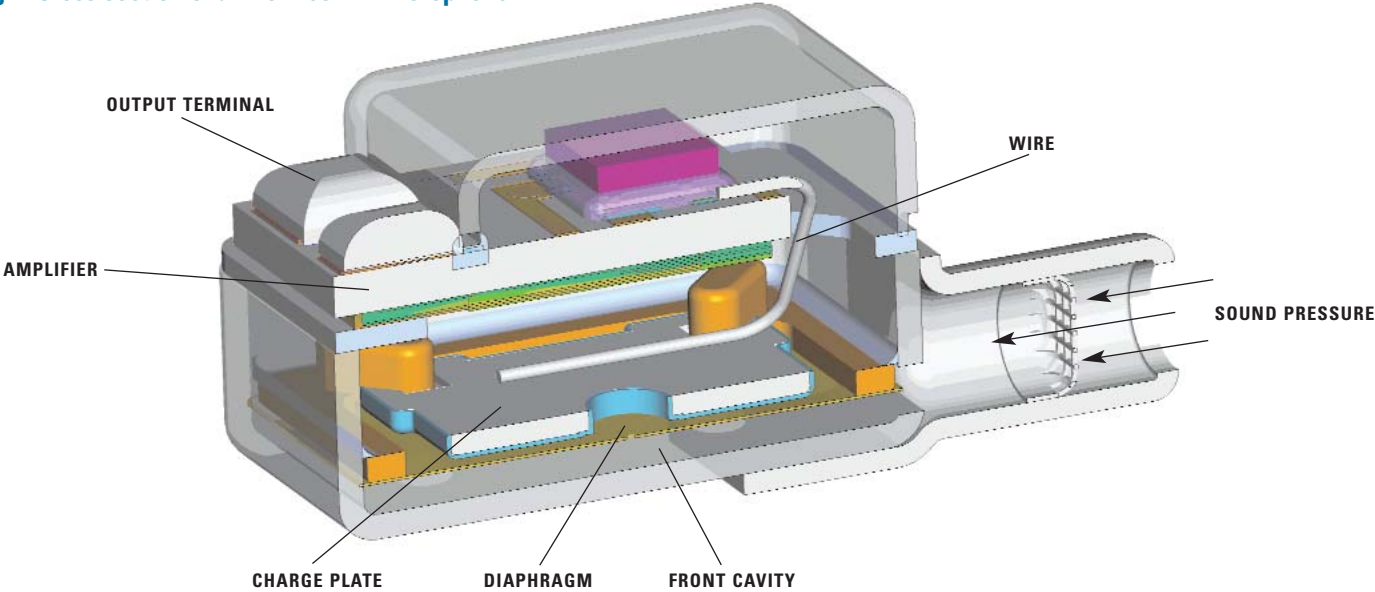
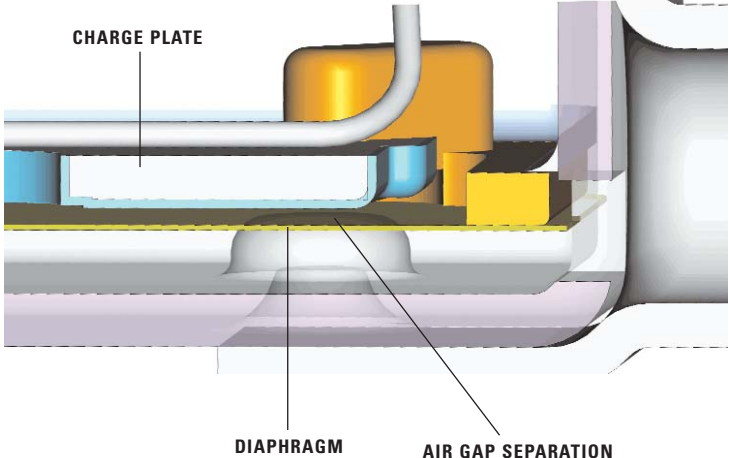

FIG. 2: EM diaphragm and electret



MICROPHONE AND SPEAKER BASICS

SPEAKERS

The speaker converts an electrical signal into sound. A cross section of a typical Knowles speaker is shown in Fig. 3. The basic components of the speaker are: a coil of wire, a metal U-shaped reed called the armature, a pair of permanent magnets, a drive rod, and a diaphragm.

The coil and armature act as an electromagnet. An alternating current in the coil causes the polarity of the armature to switch back and forth from north to south. The free end of the armature bends slightly up and down as it is attracted alternately to the top and bottom magnets (Fig. 4). The diaphragm, pulled along by the drive rod, pumps air in and out of the speaker. The mechanical motion of the armature is thus converted into sound.

The sound output of a typical Knowles' speaker is measured in units of dB SPL (sound pressure level) relative to 20 μ Pa.

Fig. 3: Cross section of a Knowles EH speaker

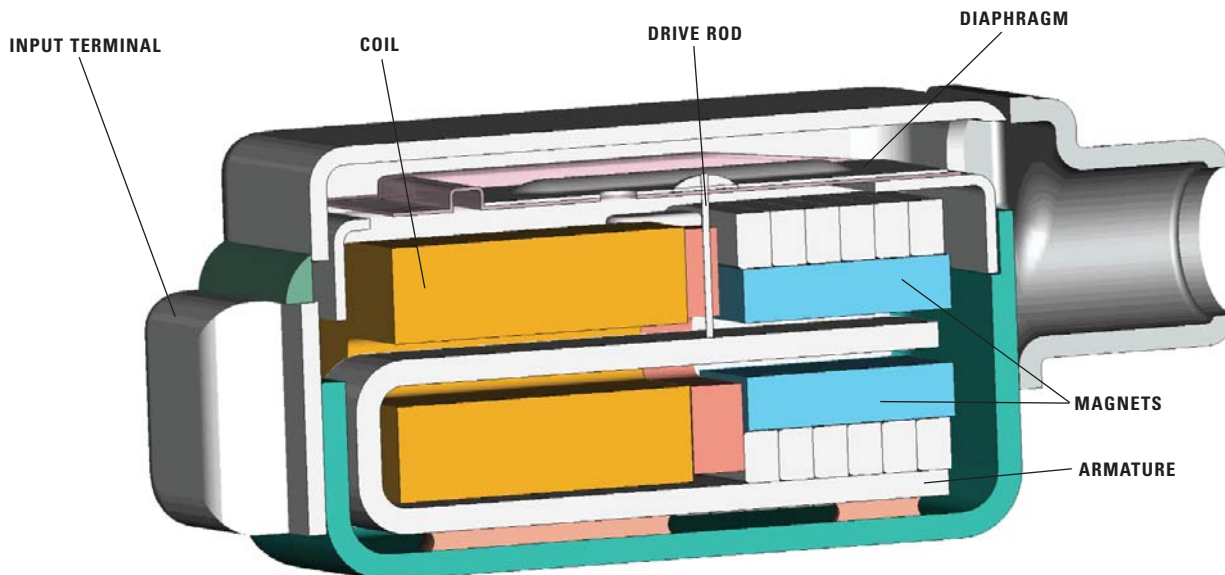
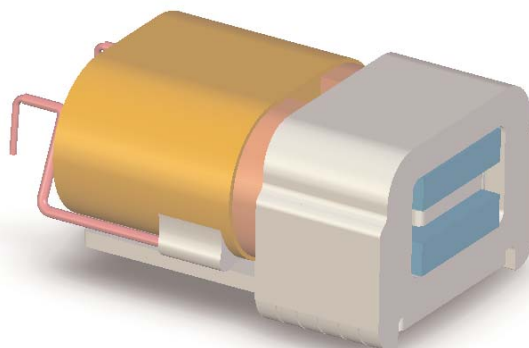

Fig. 4: The motor of the speaker has a coil, an armature, and a pair of permanent magnets.



Globally Positioned

AMERICAS

EMEA / ASIA PACIFIC



- World Headquarters
- Manufacturing
- Sales & Application Engineering

*Knowles Acoustics maintains sales, marketing, engineering and manufacturing globally.
For immediate assistance on your specific requirements, please call the nearest facility listed below.*

www.knowles.com

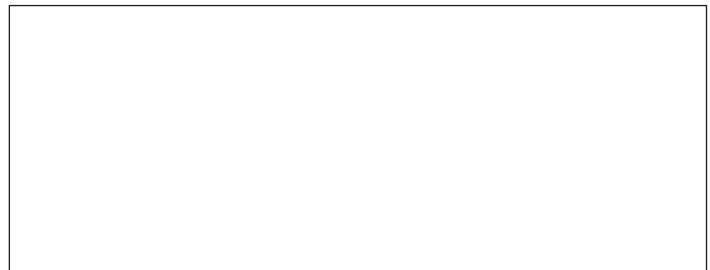

AMERICAS:

Knowles Acoustics
1151 Maplewood Drive
Itasca, IL 60143 U.S.A.
Phone: 630-250-5930
Fax: 630-250-5932

EUROPE:

Knowles Acoustics
Havnevej 7
DK-4000 Roskilde
Denmark
Phone: +45 70 25 35 70
Fax: +45 70 25 35 71

JAPAN:

Knowles Acoustics
2-2-16 Sanganjaya
Setagaya-Ku, Tokyo
154-0024 Japan
Phone: 81-3-5779-8503
Fax: 81-3-5779-8523

KOREA:

Knowles Acoustics
#1107, Parkview Tower,
Jeongja-dong 6,
Bundang-gu, Seongnam-si,
Kyeonggi-do, Korea
Phone: 82-31-712-2223
Fax: 82-31-712-3314

ASIA:

Knowles Acoustics
5F, No. 129, Lane 235, Bauchiau Rd.
Shindian City, Taipei 23145, Taiwan
Phone: 886-2-8919-1799
Fax: 886-2-8919-1798

Компания «Океан Электроники» предлагает заключение долгосрочных отношений при поставках импортных электронных компонентов на взаимовыгодных условиях!

Наши преимущества:

- Поставка оригинальных импортных электронных компонентов напрямую с производств Америки, Европы и Азии, а так же с крупнейших складов мира;
- Широкая линейка поставок активных и пассивных импортных электронных компонентов (более 30 млн. наименований);
- Поставка сложных, дефицитных, либо снятых с производства позиций;
- Оперативные сроки поставки под заказ (от 5 рабочих дней);
- Экспресс доставка в любую точку России;
- Помощь Конструкторского Отдела и консультации квалифицированных инженеров;
- Техническая поддержка проекта, помощь в подборе аналогов, поставка прототипов;
- Поставка электронных компонентов под контролем ВП;
- Система менеджмента качества сертифицирована по Международному стандарту ISO 9001;
- При необходимости вся продукция военного и аэрокосмического назначения проходит испытания и сертификацию в лаборатории (по согласованию с заказчиком);
- Поставка специализированных компонентов военного и аэрокосмического уровня качества (Xilinx, Altera, Analog Devices, Intersil, Interpoint, Microsemi, Actel, Aeroflex, Peregrine, VPT, Syfer, Eurofarad, Texas Instruments, MS Kennedy, Miteq, Cobham, E2V, MA-COM, Hittite, Mini-Circuits, General Dynamics и др.);

Компания «Океан Электроники» является официальным дистрибьютором и эксклюзивным представителем в России одного из крупнейших производителей разъемов военного и аэрокосмического назначения «**JONHON**», а так же официальным дистрибьютором и эксклюзивным представителем в России производителя высокотехнологичных и надежных решений для передачи СВЧ сигналов «**FORSTAR**».



JONHON

«**JONHON**» (основан в 1970 г.)

Разъемы специального, военного и аэрокосмического назначения:

(Применяются в военной, авиационной, аэрокосмической, морской, железнодорожной, горно- и нефтедобывающей отраслях промышленности)

«**FORSTAR**» (основан в 1998 г.)

ВЧ соединители, коаксиальные кабели, кабельные сборки и микроволновые компоненты:

(Применяются в телекоммуникациях гражданского и специального назначения, в средствах связи, РЛС, а так же военной, авиационной и аэрокосмической отраслях промышленности).



Телефон: 8 (812) 309-75-97 (многоканальный)

Факс: 8 (812) 320-03-32

Электронная почта: ocean@oceanchips.ru

Web: <http://oceanchips.ru/>

Адрес: 198099, г. Санкт-Петербург, ул. Калинина, д. 2, корп. 4, лит. А