



ERU chokes

ERU 19, helically wound

Series/Type: **B82559*A019**

Date: June 2016

© EPCOS AG 2016. Reproduction, publication and dissemination of this publication, enclosures hereto and the information contained therein without EPCOS' prior express consent is prohibited.

EPCOS AG is a TDK Group Company.

SMD

Rated inductance 1.0 30 μ H
Saturation current 10.1 ... 43 A

Construction

- High temperature ferrite core
- Magnetically shielded
- Helical winding
- Self-leaded construction
- Under body termination
- 3 pins for improved reliability

Features

- High rated current
- Extremely low DC resistance
- Very low profile and extremely small footprint
- Suitable for pick-and-place processes
- RoHS-compatible
- Easily customized
- AEC-Q200 qualified

Applications

Energy storage chokes for

- DC-DC converters
- VRM modules
- POL converters
- Solar converters

Terminals

Lead-free tinned

Marking

Manufacturer, ordering code, date of manufacture and production place (YYWWD/X),

Delivery mode and packing units

- Blister tape

SMD

Dimensional drawing and layout recommendation

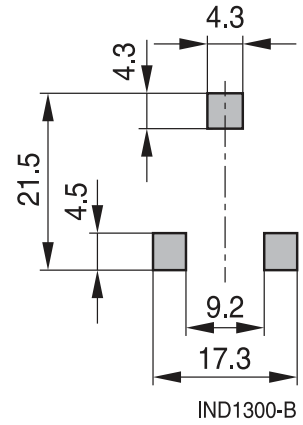
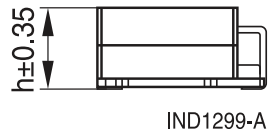
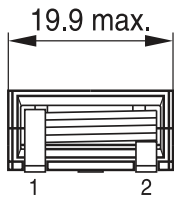
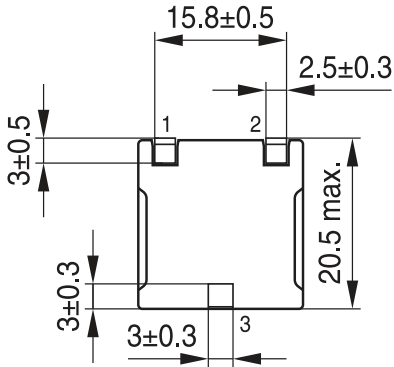

Dimensions in mm

Circuit diagram

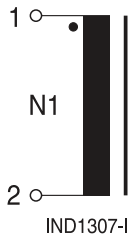

SMD

Taping and packing

Tape:

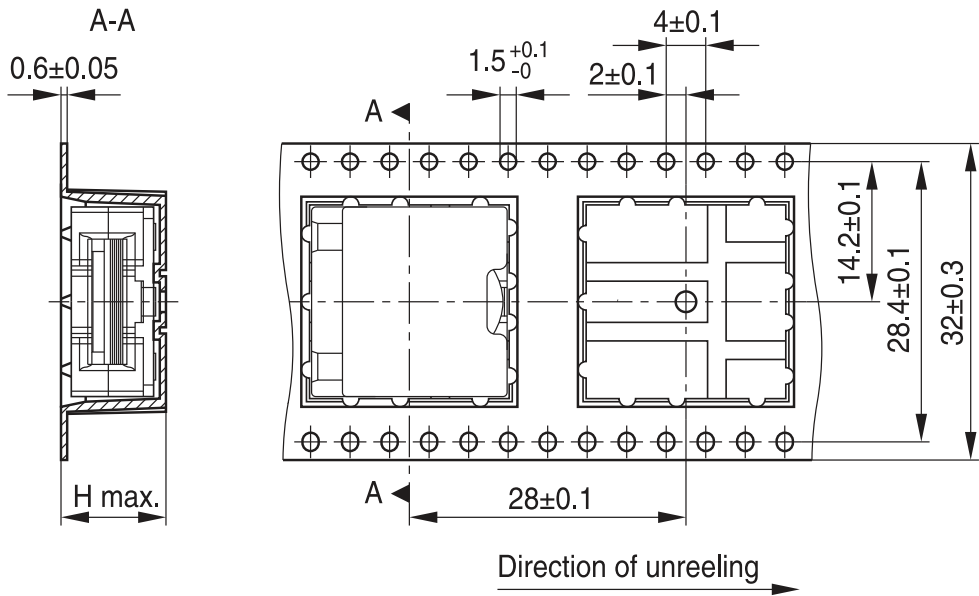

IND1301-C-E

Dimensions in mm

Reel:

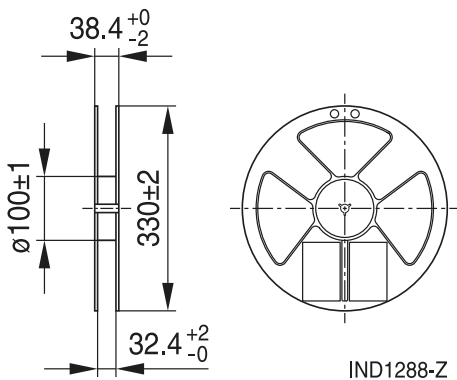

IND1288-Z

Dimensions in mm

| Height (mm) | | Packing unit per reel |
|-------------|----------|--------------------------|
| component h | cavity H | |
| 8.35 | 10.2 | 240 |
| 9.15 | 11.0 | 200 |
| 9.75 | 11.6 | 190 |
| 10.85 | 12.7 | 160 |

SMD
Technical data and measuring conditions

| | |
|--|---|
| Rated inductance L_R | Measured at 100 kHz, 0.1 V, +25 °C |
| Inductance tolerance | ±10% |
| Saturation current I_{Sat} | Current that will result in an approximately 20% drop in the inductance values at the specified temperature |
| DC resistance R_{DC} | Measured at +25 °C |
| Self-resonant frequency | > 2 MHz |
| High voltage: N1 - core | 200 V DC, 1 s |
| Solderability (test of wettability of the pins) | (245 ±5) °C, (3 ±0.3) s, wetting of soldering area ≥95% (based on IEC 60068-2-58, solder bath method) |
| Resistance to soldering heat | To JEDEC J-STD 020D (Tc: +245 °C on pin) |
| Operating temperature | -40 °C ... +150 °C (component) |
| Storage conditions (packaged) | -25 °C ... +40 °C, ≤ 75% RH |

Characteristics and ordering codes

| L_R | $I_{sat, 25°C}$ | $I_{sat, 100°C}$ | R_{DC} (max) | R_{DC} (typ) | Height h (nom.) | Approx. weight | Ordering code |
|-------|-----------------|------------------|----------------|----------------|--------------------|-------------------|-----------------|
| μH | A | A | mΩ | mΩ | mm | g | |
| 1.0 | 43.0 | 37.5 | 1.20 | 0.95 | 8.35 | 9.8 | B82559A2102A019 |
| 1.5 | 42.5 | 36.3 | 1.70 | 1.45 | 9.15 | 10.3 | B82559A3152A019 |
| 2.2 | 37.8 | 32.2 | 2.20 | 1.80 | 9.75 | 11.1 | B82559A4222A019 |
| 3.3 | 31.5 | 27.0 | 2.70 | 2.30 | 10.85 | 12.7 | B82559A5332A019 |
| 4.7 | 23.0 | 20.2 | 2.70 | 2.30 | 10.85 | 12.7 | B82559A5472A019 |
| 6.8 | 18.6 | 16.4 | 8.25 | 7.70 | 8.35 | 9.3 | B82559A6682A019 |
| 10.0 | 14.4 | 12.7 | 9.55 | 8.90 | 8.35 | 9.6 | B82559A7103A019 |
| 15.0 | 13.0 | 11.4 | 12.15 | 11.35 | 9.15 | 10.7 | B82559A9153A019 |
| 20.0 | 12.0 | 10.6 | 14.75 | 13.75 | 9.75 | 11.8 | B82559A0203A019 |
| 30.0 | 10.1 | 8.7 | 18.65 | 17.35 | 10.85 | 13.0 | B82559A0303A019 |

SMD

Inductance L versus DC load current I_{DC}

The temperature rise ΔT is measured at an ambient temperature of +25 °C. A current is applied for 30 minutes and the temperature is measured via a thermocouple placed on top of the device. No forced air cooling is applied.

The inductance vs current curves are generated by measuring the inductors at +25 °C and +100 °C.

B82559A2102A019

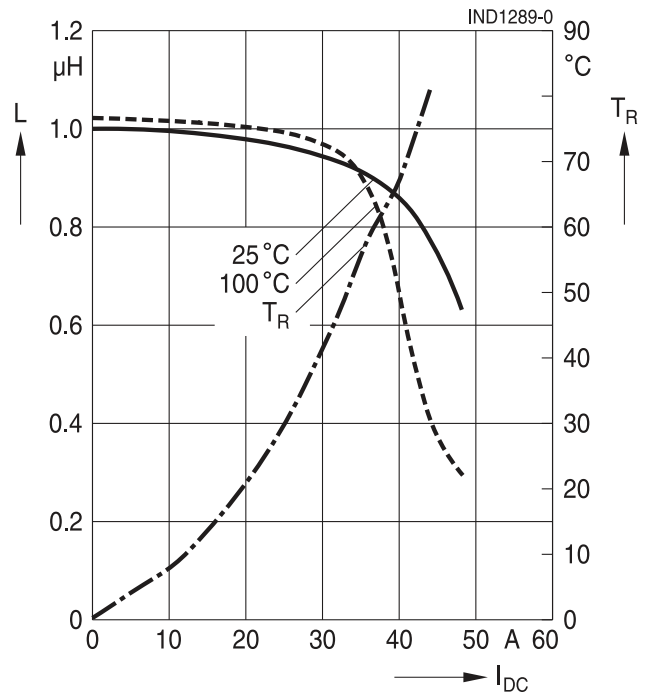

B82559A3152A019

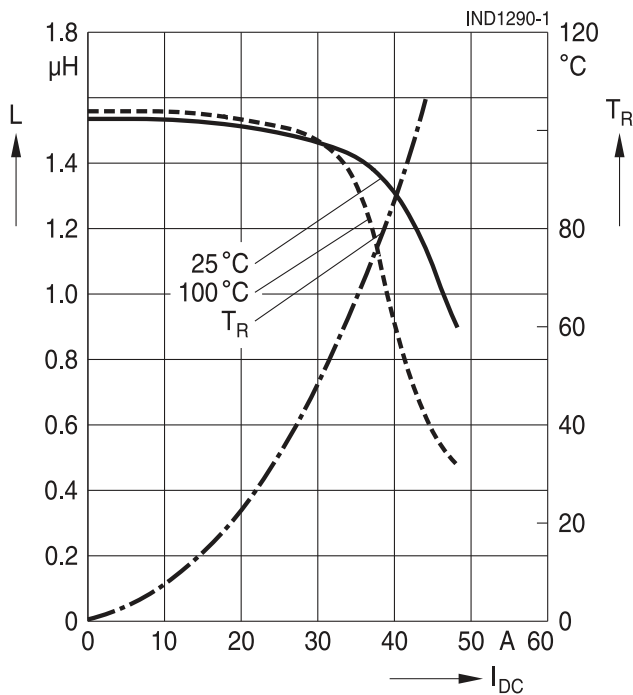

B82559A4222A019

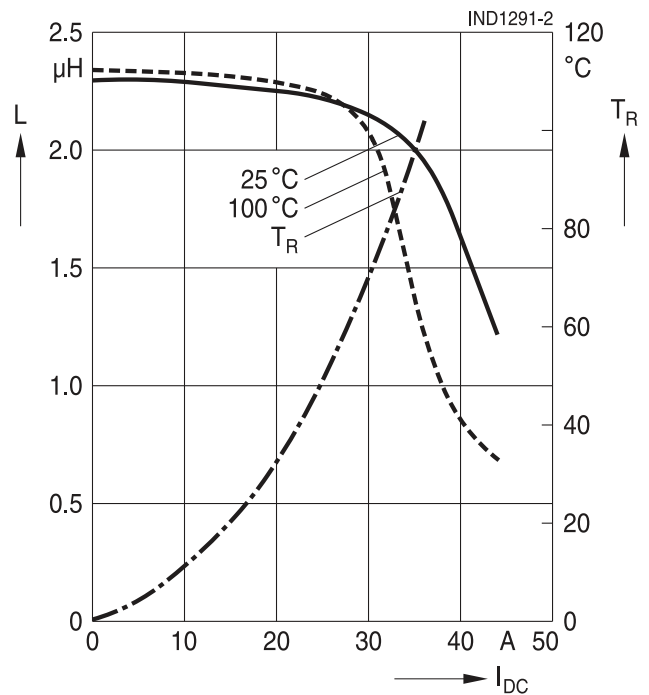

SMD

B82559A5332A019

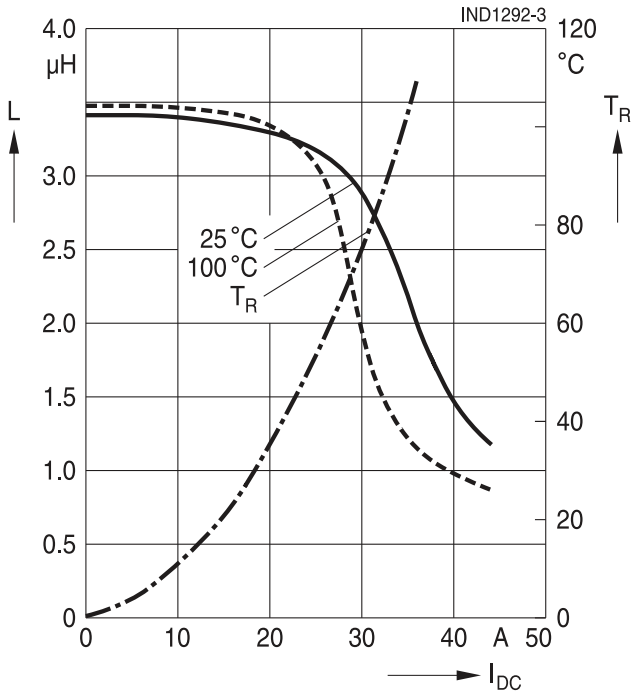

B82559A5472A019

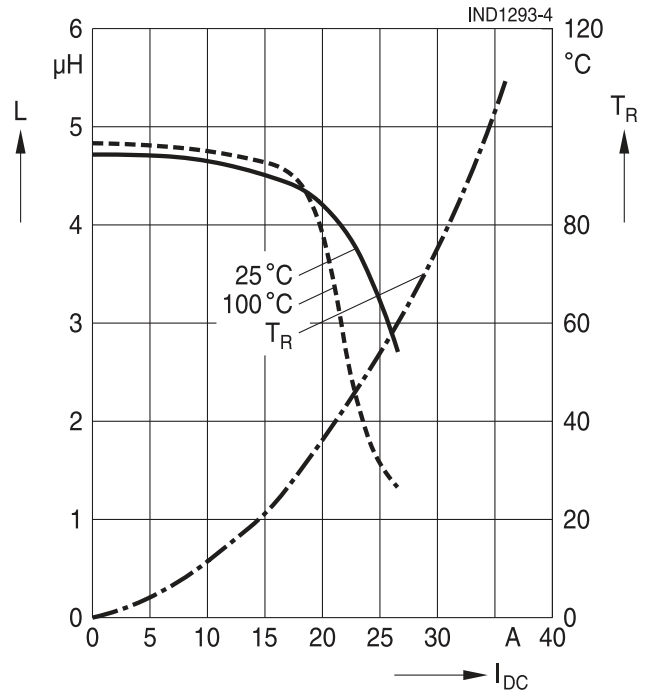

B82559A6682A019

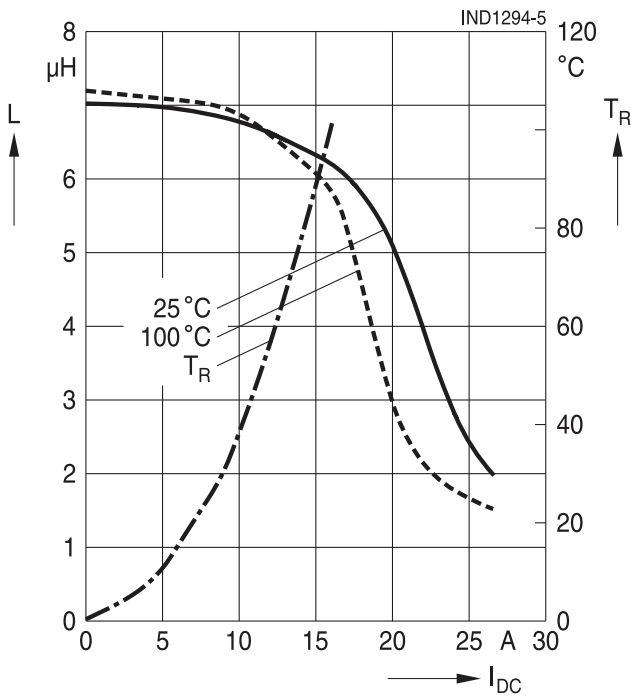

B82559A7103A019

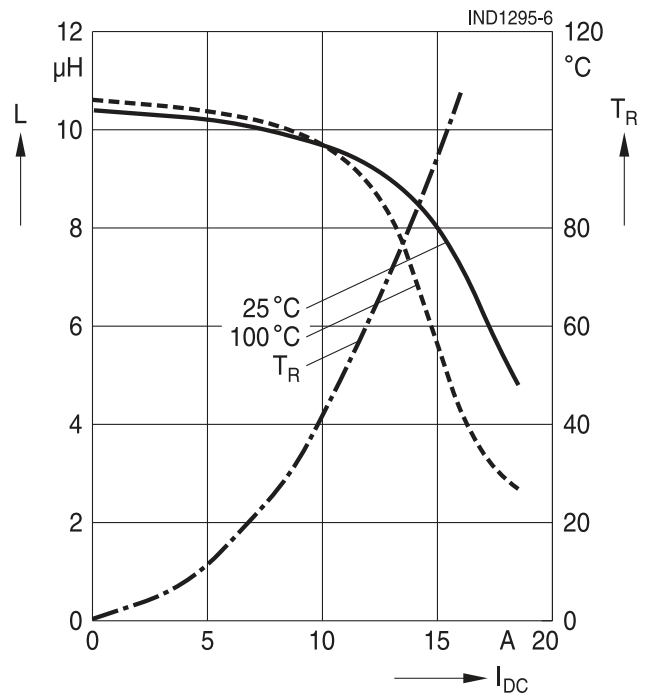

B82559A9153A019

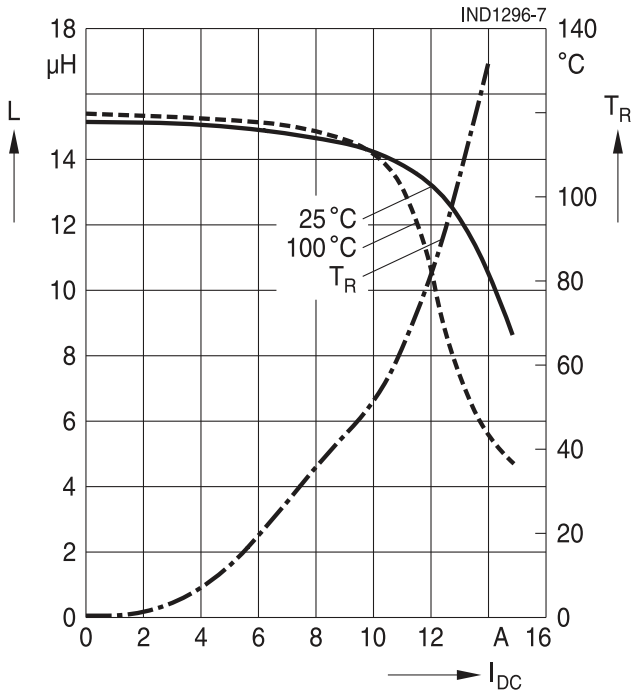

B82559A0203A019

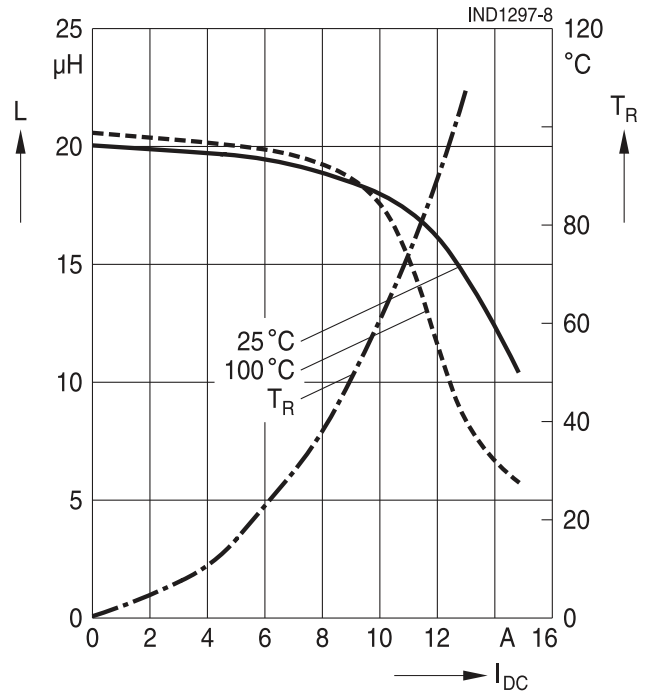

B82559A0303A019

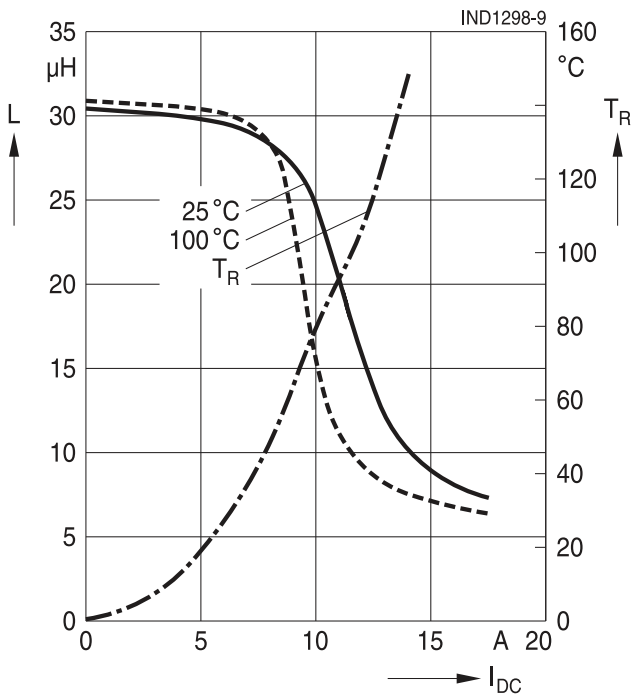

Cautions and warnings

- Please note the recommendations in our Inductors data book (latest edition) and in the data sheets.
 - Particular attention should be paid to the derating curves given there.
 - The soldering conditions should also be observed. Temperatures quoted in relation to wave soldering refer to the pin, not the housing.
- If the components are to be washed varnished it is necessary to check whether the washing varnish agent that is used has a negative effect on the wire insulation, any plastics that are used, or on glued joints. In particular, it is possible for washing varnish agent residues to have a negative effect in the long-term on wire insulation.
Washing processes may damage the product due to the possible static or cyclic mechanical loads (e.g. ultrasonic cleaning). They may cause cracks to develop on the product and its parts, which might lead to reduced reliability or lifetime.
- The following points must be observed if the components are potted in customer applications:
 - Many potting materials shrink as they harden. They therefore exert a pressure on the plastic housing or core. This pressure can have a deleterious effect on electrical properties, and in extreme cases can damage the core or plastic housing mechanically.
 - It is necessary to check whether the potting material used attacks or destroys the wire insulation, plastics or glue.
 - The effect of the potting material can change the high-frequency behaviour of the components.
- Ferrites are sensitive to direct impact. This can cause the core material to flake, or lead to breakage of the core.
- Even for customer-specific products, conclusive validation of the component in the circuit can only be carried out by the customer.

Display of ordering codes for EPCOS products

The ordering code for one and the same product can be represented differently in data sheets, data books, other publications and the website of EPCOS, or in order-related documents such as shipping notes, order confirmations and product labels. **The varying representations of the ordering codes are due to different processes employed and do not affect the specifications of the respective products.** Detailed information can be found on the Internet under www.epcos.com/orderingcodes.

Important notes

The following applies to all products named in this publication:

1. Some parts of this publication contain **statements about the suitability of our products for certain areas of application**. These statements are based on our knowledge of typical requirements that are often placed on our products in the areas of application concerned. We nevertheless expressly point out **that such statements cannot be regarded as binding statements about the suitability of our products for a particular customer application**. As a rule we are either unfamiliar with individual customer applications or less familiar with them than the customers themselves. For these reasons, it is always ultimately incumbent on the customer to check and decide whether a product with the properties described in the product specification is suitable for use in a particular customer application.
2. We also point out that **in individual cases, a malfunction of electronic components or failure before the end of their usual service life cannot be completely ruled out in the current state of the art, even if they are operated as specified**. In customer applications requiring a very high level of operational safety and especially in customer applications in which the malfunction or failure of an electronic component could endanger human life or health (e.g. in accident prevention or life-saving systems), it must therefore be ensured by means of suitable design of the customer application or other action taken by the customer (e.g. installation of protective circuitry or redundancy) that no injury or damage is sustained by third parties in the event of malfunction or failure of an electronic component.
3. **The warnings, cautions and product-specific notes must be observed.**
4. In order to satisfy certain technical requirements, **some of the products described in this publication may contain substances subject to restrictions in certain jurisdictions (e.g. because they are classed as hazardous)**. Useful information on this will be found in our Material Data Sheets on the Internet (www.tdk-electronics.tdk.com/material). Should you have any more detailed questions, please contact our sales offices.
5. We constantly strive to improve our products. Consequently, **the products described in this publication may change from time to time**. The same is true of the corresponding product specifications. Please check therefore to what extent product descriptions and specifications contained in this publication are still applicable before or when you place an order.

We also **reserve the right to discontinue production and delivery of products**. Consequently, we cannot guarantee that all products named in this publication will always be available. The aforementioned does not apply in the case of individual agreements deviating from the foregoing for customer-specific products.
6. Unless otherwise agreed in individual contracts, **all orders are subject to our General Terms and Conditions of Supply**.
7. **Our manufacturing sites serving the automotive business apply the IATF 16949 standard**. The IATF certifications confirm our compliance with requirements regarding the quality management system in the automotive industry. Referring to customer requirements and customer specific requirements ("CSR") TDK always has and will continue to have the policy of respecting individual agreements. Even if IATF 16949 may appear to support the acceptance of unilateral requirements, we hereby like to emphasize that **only requirements mutually agreed upon can and will be implemented in our Quality Management System**. For clarification purposes we like to point out that obligations from IATF 16949 shall only become legally binding if individually agreed upon.
8. The trade names EPCOS, CeraCharge, CeraDiode, CeraLink, CeraPad, CeraPlas, CSMP, CTVS, DeltaCap, DigiSiMic, ExoCore, FilterCap, FormFit, LeaXield, MiniBlue, MiniCell, MKD, MKK, MotorCap, PCC, PhaseCap, PhaseCube, PhaseMod, PhiCap, PowerHap, PQSine, PQvar, SIFERRIT, SIFI, SIKOREL, SilverCap, SIMDAD, SiMic, SIMID, SineFormer, SIOV, ThermoFuse, WindCap are **trademarks registered or pending** in Europe and in other countries. Further information will be found on the Internet at www.tdk-electronics.tdk.com/trademarks.

Release 2018-10

Mouser Electronics

Authorized Distributor

Click to View Pricing, Inventory, Delivery & Lifecycle Information:

EPCOS / TDK:

[B82559A3152A019](#) [B82559A5472A019](#) [B82559A6682A019](#) [B82559A7103A019](#) [B82559A5332A019](#)
[B82559A0303A019](#) [B82559A2102A019](#) [B82559A4222A019](#) [B82559A0203A019](#) [B82559A9153A019](#)

Компания «Океан Электроники» предлагает заключение долгосрочных отношений при поставках импортных электронных компонентов на взаимовыгодных условиях!

Наши преимущества:

- Поставка оригинальных импортных электронных компонентов напрямую с производств Америки, Европы и Азии, а так же с крупнейших складов мира;
- Широкая линейка поставок активных и пассивных импортных электронных компонентов (более 30 млн. наименований);
- Поставка сложных, дефицитных, либо снятых с производства позиций;
- Оперативные сроки поставки под заказ (от 5 рабочих дней);
- Экспресс доставка в любую точку России;
- Помощь Конструкторского Отдела и консультации квалифицированных инженеров;
- Техническая поддержка проекта, помощь в подборе аналогов, поставка прототипов;
- Поставка электронных компонентов под контролем ВП;
- Система менеджмента качества сертифицирована по Международному стандарту ISO 9001;
- При необходимости вся продукция военного и аэрокосмического назначения проходит испытания и сертификацию в лаборатории (по согласованию с заказчиком);
- Поставка специализированных компонентов военного и аэрокосмического уровня качества (Xilinx, Altera, Analog Devices, Intersil, Interpoint, Microsemi, Actel, Aeroflex, Peregrine, VPT, Syfer, Eurofarad, Texas Instruments, MS Kennedy, Miteq, Cobham, E2V, MA-COM, Hittite, Mini-Circuits, General Dynamics и др.);

Компания «Океан Электроники» является официальным дистрибьютором и эксклюзивным представителем в России одного из крупнейших производителей разъемов военного и аэрокосмического назначения «JONHON», а так же официальным дистрибьютором и эксклюзивным представителем в России производителя высокотехнологичных и надежных решений для передачи СВЧ сигналов «FORSTAR».



JONHON

«JONHON» (основан в 1970 г.)

Разъемы специального, военного и аэрокосмического назначения:

(Применяются в военной, авиационной, аэрокосмической, морской, железнодорожной, горно- и нефтедобывающей отраслях промышленности)

«FORSTAR» (основан в 1998 г.)

ВЧ соединители, коаксиальные кабели, кабельные сборки и микроволновые компоненты:

(Применяются в телекоммуникациях гражданского и специального назначения, в средствах связи, РЛС, а так же военной, авиационной и аэрокосмической отраслях промышленности).



Телефон: 8 (812) 309-75-97 (многоканальный)

Факс: 8 (812) 320-03-32

Электронная почта: ocean@oceanchips.ru

Web: <http://oceanchips.ru/>

Адрес: 198099, г. Санкт-Петербург, ул. Калинина, д. 2, корп. 4, лит. А