

Section 3: Introduction



Foreword

AVX offers a broad line of solid Tantalum capacitors in a wide range of sizes, styles, and ratings to meet any design needs. This catalog combines into one source AVX's leaded tantalum capacitor information from its worldwide tantalum operations.

The TAP/TEP is rated for use from -55°C to +85°C at rated voltage and up to +125°C with voltage derating. There are three preferred wire forms to choose from which are available on tape and reel, and in bulk for hand insertion.

AVX has a complete tantalum applications service available for use by all our customers. With the capability to prototype and mass produce solid tantalum capacitors in special configurations, almost any design need can be fulfilled.

And if the customer requirements are outside our standard testing, AVX will work with you to define and implement a test or screening plan.

AVX is determined to become the world leader in tantalum capacitor technology and has made, and is continuing to make, significant investments in equipment and research to reach that end. We believe that the investment has paid off with the devices shown on the following pages.

Dipped Radial Capacitors

SOLID TANTALUM RESIN DIPPED SERIES TAP/TEP

The TAP/TEP resin dipped series of miniature tantalum capacitors is available for individual needs in both commercial and professional applications. From computers to automotive to industrial, AVX has a dipped radial for almost any application.



Dipped Radial Capacitors



Wire Form Outline

SOLID TANTALUM RESIN DIPPED TAP/TEP

Preferred Wire Forms

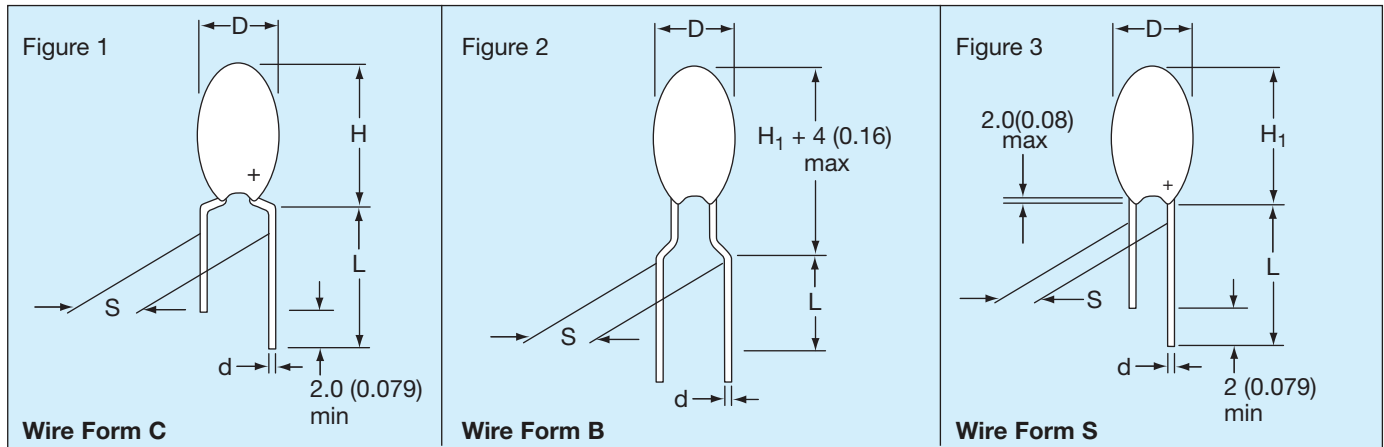

Non-Preferred Wire Forms (Not recommended for new designs)

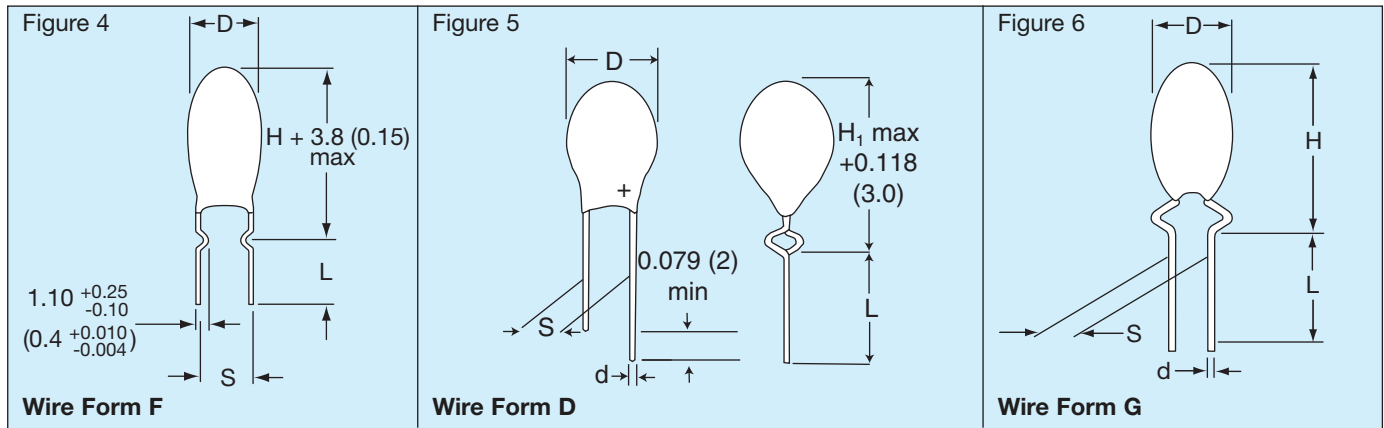

DIMENSIONS

millimeters (inches)

| Wire Form | Figure | Case Size | L (see note 1) | S | d | Packaging Suffixes Available* |
|-----------|--------|-----------|----------------|---|---|-------------------------------|
|-----------|--------|-----------|----------------|---|---|-------------------------------|

Preferred Wire Forms

| | | | | | | |
|---|----------|--------|----------------------------|----------------------------|----------------------------|--|
| C | Figure 1 | A - R* | 16.0±4.00 (0.630±0.160) | 5.00±1.00 (0.200±0.040) | 0.50±0.05 (0.020±0.002) | CCS Bulk CRW Tape/Reel CRS Tape/Ammo |
| B | Figure 2 | A - J* | 16.0±4.00 (0.630±0.160) | 5.00±1.00 (0.200±0.040) | 0.50±0.05 (0.020±0.002) | BRW Tape/Reel BRS Tape/Ammo |
| S | Figure 3 | A - J* | 16.0±4.00 (0.630±0.160) | 2.50±0.50 (0.100±0.020) | 0.50±0.05 (0.020±0.002) | SCS Bulk SRW Tape/Reel SRS Tape/Ammo |

Non-Preferred Wire Forms (Not recommended for new designs)

| | | | | | | |
|---|---------------------|--------|----------------------------|----------------------------|----------------------------|--|
| F | Figure 4 | A - R | 3.90±0.75 (0.155±0.030) | 5.00±0.50 (0.200±0.020) | 0.50±0.05 (0.020±0.002) | FCS Bulk |
| D | Figure 5 | A - H* | 16.0±4.00 (0.630±0.160) | 2.50±0.75 (0.100±0.020) | 0.50±0.05 (0.020±0.002) | DCS Bulk DTW Tape/Reel DTS Tape/Ammo |
| G | Figure 6 | A - J | 16.0±4.00 (0.630±0.160) | 3.18±0.50 (0.125±0.020) | 0.50±0.05 (0.020±0.002) | GSB Bulk |
| H | Similar to Figure 1 | A - R | 16.0±4.00 (0.630±0.160) | 6.35±1.00 (0.250±0.040) | 0.50±0.05 (0.020±0.002) | HSB Bulk |

Notes: (1) Lead lengths can be supplied to tolerances other than those above and should be specified in the ordering information.

(2) For D, H, and H₁ dimensions, refer to individual product on following pages.

* For case size availability in tape and reel, please refer to pages 101-102.

Dipped Radial Capacitors



TAP Series

SOLID TANTALUM RESIN DIPPED CAPACITORS



TAP is a professional grade device manufactured with a flame retardant coating and featuring low leakage current and impedance, very small physical sizes and exceptional temperature stability. It is designed and conditioned to operate to +125°C (see page 132 for voltage derating above 85°C) and is available loose or taped and reeled for auto insertion. The 15 case sizes with wide capacitance and working voltage ranges means the TAP can accommodate almost any application.



MAXIMUM CASE DIMENSIONS: millimeters (inches)

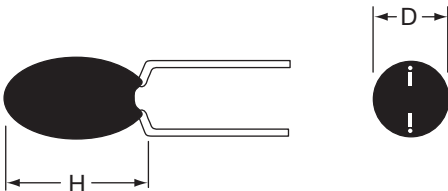

| Wire Case | C, F, G, H H | B, S, D *H ₁ | D |
|-----------|-----------------|----------------------------|--------------|
| A | 8.50 (0.330) | 7.00 (0.280) | 4.50 (0.180) |
| B | 9.00 (0.350) | 7.50 (0.300) | 4.50 (0.180) |
| C | 10.0 (0.390) | 8.50 (0.330) | 5.00 (0.200) |
| D | 10.5 (0.410) | 9.00 (0.350) | 5.00 (0.200) |
| E | 10.5 (0.410) | 9.00 (0.350) | 5.50 (0.220) |
| F | 11.5 (0.450) | 10.0 (0.390) | 6.00 (0.240) |
| G | 11.5 (0.450) | 10.0 (0.390) | 6.50 (0.260) |
| H | 12.0 (0.470) | 10.5 (0.410) | 7.00 (0.280) |
| J | 13.0 (0.510) | 11.5 (0.450) | 8.00 (0.310) |
| K | 14.0 (0.550) | 12.5 (0.490) | 8.50 (0.330) |
| L | 14.0 (0.550) | 12.5 (0.490) | 9.00 (0.350) |
| M | 14.5 (0.570) | 13.0 (0.510) | 9.00 (0.350) |
| N | 16.0 (0.630) | | 9.00 (0.350) |
| P | 17.0 (0.670) | | 10.0 (0.390) |
| R | 18.5 (0.730) | | 10.0 (0.390) |

HOW TO ORDER

TAP

Type

475

Capacitance Code
pF code: 1st two digits represent significant figures, 3rd digit represents multiplier (number of zeros to follow)

M

Capacitance Tolerance
K = ±10%
M = ±20%
(For J = ±5% tolerance, please consult factory)

035

Rated DC Voltage

SCS

Suffix indicating wire form and packaging
(see page 94)



Dipped Radial Capacitors



TAP Series

TECHNICAL SPECIFICATIONS

| | | | | | | | | |
|-------------------------------|---|-----|-----|----|----|----|----|----|
| Technical Data: | All technical data relate to an ambient temperature of +25°C | | | | | | | |
| Capacitance Range: | 0.10 μ F to 330 μ F | | | | | | | |
| Capacitance Tolerance: | \pm 20%; \pm 10% (\pm 5% consult your AVX representative for details) | | | | | | | |
| Rated Voltage DC (V_R) | $\leq +85^\circ\text{C}$: | 6.3 | 10 | 16 | 20 | 25 | 35 | 50 |
| Category Voltage (V_C) | $\leq +125^\circ\text{C}$: | 4 | 6.3 | 10 | 13 | 16 | 23 | 33 |
| Surge Voltage (V_S) | $\leq +85^\circ\text{C}$: | 8 | 13 | 20 | 26 | 33 | 46 | 65 |
| Surge Voltage (V_S) | $\leq +125^\circ\text{C}$: | 5 | 9 | 12 | 16 | 21 | 28 | 40 |
| Temperature Range: | -55°C to +125°C | | | | | | | |
| Environmental Classification: | 55/125/56 (IEC 68-2) | | | | | | | |
| Dissipation Factor: | \leq 0.04 for C_R 0.1-1.5 μ F | | | | | | | |
| | \leq 0.06 for C_R 2.2-6.8 μ F | | | | | | | |
| | \leq 0.08 for C_R 10-68 μ F | | | | | | | |
| | \leq 0.10 for C_R 100-330 μ F | | | | | | | |
| Reliability: | 1% per 1000 hrs. at 85°C with 0.1 Ω /V series impedance, 60% confidence level. | | | | | | | |
| Qualification: | CECC 30201 - 032 | | | | | | | |

| Capacitance Range (letter denotes case size) | | | | | | | | |
|--|------|----------------------------|-----|-----|-----|-----|-----|-----|
| Capacitance | | Rated voltage DC (V_R) | | | | | | |
| μ F | Code | 6.3V | 10V | 16V | 20V | 25V | 35V | 50V |
| 0.10 | 104 | | | | | | A | A |
| 0.15 | 154 | | | | | | A | A |
| 0.22 | 224 | | | | | | A | A |
| 0.33 | 334 | | | | | | A | A |
| 0.47 | 474 | | | | | | A | A |
| 0.68 | 684 | | | | | | A | B |
| 1.0 | 105 | | | | A | A | A | C |
| 1.5 | 155 | | | A | A | A | A | D |
| 2.2 | 225 | | A | A | A | A | B | E |
| 3.3 | 335 | A | A | A | B | B | C | F |
| 4.7 | 475 | A | A | B | C | C | E | G |
| 6.8 | 685 | A | B | C | D | D | F | H |
| 10 | 106 | B | C | D | E | E | F | J |
| 15 | 156 | C | D | E | F | F | H | K |
| 22 | 226 | D | E | F | H | H | K | L |
| 33 | 336 | E | F | F | J | J | M | |
| 47 | 476 | F | G | J | K | M | N | |
| 68 | 686 | G | H | L | N | N | | |
| 100 | 107 | H | K | N | N | | | |
| 150 | 157 | K | N | N | | | | |
| 220 | 227 | M | P | R | | | | |
| 330 | 337 | P | R | | | | | |

Values outside this standard range may be available on request.
 AVX reserves the right to supply capacitors to a higher voltage rating, in the same case size, than that ordered.

MARKING

Polarity, capacitance, rated DC voltage, and an "A" (AVX logo) are laser marked on the capacitor body which is made of flame retardant gold epoxy resin with a limiting oxygen index in excess of 30 (ASTM-D-2863).

- Polarity
- Capacitance
- Voltage
- AVX logo
- Tolerance code:
 - \pm 20% = Standard (no marking)
 - \pm 10% = "K" on reverse side of unit
 - \pm 5% = "J" on reverse side of unit

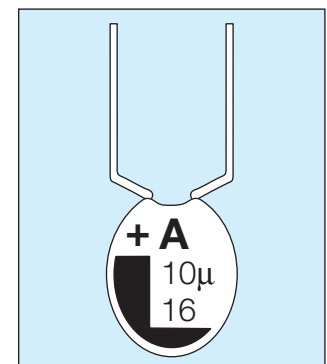

Dipped Radial Capacitors



TAP Series

RATINGS AND PART NUMBER REFERENCE

| AVX Part No. | Case Size | Capacitance μF | DCL (μA) Max. | DF % Max. | ESR Max. (Ω) @ 100 kHz |
|--|-----------|---------------------------|----------------------------|-----------|---------------------------------|
| 6.3 volt @ 85°C (4 volt @ 125°C) | | | | | |
| TAP 335(+006 | A | 3.3 | 0.5 | 6 | 13.0 |
| TAP 475(+006 | A | 4.7 | 0.5 | 6 | 10.0 |
| TAP 685(+006 | A | 6.8 | 0.5 | 6 | 8.0 |
| TAP 106(+006 | B | 10 | 0.5 | 8 | 6.0 |
| TAP 156(+006 | C | 15 | 0.8 | 8 | 5.0 |
| TAP 226(+006 | D | 22 | 1.1 | 8 | 3.7 |
| TAP 336(+006 | E | 33 | 1.7 | 8 | 3.0 |
| TAP 476(+006 | F | 47 | 2.4 | 8 | 2.0 |
| TAP 686(+006 | G | 68 | 3.4 | 8 | 1.8 |
| TAP 107(+006 | H | 100 | 5.0 | 10 | 1.6 |
| TAP 157(+006 | K | 150 | 7.6 | 10 | 0.9 |
| TAP 227(+006 | M | 220 | 11.0 | 10 | 0.9 |
| TAP 337(+006 | P | 330 | 16.6 | 10 | 0.7 |
| 10 volt @ 85°C (6.3 volt @ 125°C) | | | | | |
| TAP 225(+010 | A | 2.2 | 0.5 | 6 | 13.0 |
| TAP 335(+010 | A | 3.3 | 0.5 | 6 | 10.0 |
| TAP 475(+010 | A | 4.7 | 0.5 | 6 | 8.0 |
| TAP 685(+010 | B | 6.8 | 0.5 | 6 | 6.0 |
| TAP 106(+010 | C | 10 | 0.8 | 8 | 5.0 |
| TAP 156(+010 | D | 15 | 1.2 | 8 | 3.7 |
| TAP 226(+010 | E | 22 | 1.7 | 8 | 2.7 |
| TAP 336(+010 | F | 33 | 2.6 | 8 | 2.1 |
| TAP 476(+010 | G | 47 | 3.7 | 8 | 1.7 |
| TAP 686(+010 | H | 68 | 5.4 | 8 | 1.3 |
| TAP 107(+010 | K | 100 | 8.0 | 10 | 1.0 |
| TAP 157(+010 | N | 150 | 12.0 | 10 | 0.8 |
| TAP 227(+010 | P | 220 | 17.6 | 10 | 0.6 |
| TAP 337(+010 | R | 330 | 20.0 | 10 | 0.5 |
| 16 volt @ 85°C (10 volt @ 125°C) | | | | | |
| TAP 155(+016 | A | 1.5 | 0.5 | 4 | 10.0 |
| TAP 225(+016 | A | 2.2 | 0.5 | 6 | 8.0 |
| TAP 335(+016 | A | 3.3 | 0.5 | 6 | 6.0 |
| TAP 475(+016 | B | 4.7 | 0.6 | 6 | 5.0 |
| TAP 685(+016 | C | 6.8 | 0.8 | 6 | 4.0 |
| TAP 106(+016 | D | 10 | 1.2 | 8 | 3.2 |
| TAP 156(+016 | E | 15 | 1.9 | 8 | 2.5 |
| TAP 226(+016 | F | 22 | 2.8 | 8 | 2.0 |
| TAP 336(+016 | F | 33 | 4.2 | 8 | 1.6 |
| TAP 476(+016 | J | 47 | 6.0 | 8 | 1.3 |
| TAP 686(+016 | L | 68 | 8.7 | 8 | 1.0 |
| TAP 107(+016 | N | 100 | 12.8 | 10 | 0.8 |
| TAP 157(+016 | N | 150 | 19.2 | 10 | 0.6 |
| TAP 227(+016 | R | 220 | 20.0 | 10 | 0.5 |
| 20 volt @ 85°C (13 volt @ 125°C) | | | | | |
| TAP 105(+020 | A | 1.0 | 0.5 | 4 | 10.0 |
| TAP 155(+020 | A | 1.5 | 0.5 | 4 | 9.0 |
| TAP 225(+020 | A | 2.2 | 0.5 | 6 | 7.0 |
| TAP 335(+020 | B | 3.3 | 0.5 | 6 | 5.5 |
| TAP 475(+020 | C | 4.7 | 0.7 | 6 | 4.5 |
| TAP 685(+020 | D | 6.8 | 1.0 | 6 | 3.6 |
| TAP 106(+020 | E | 10 | 1.6 | 8 | 2.9 |
| TAP 156(+020 | F | 15 | 2.4 | 8 | 2.3 |
| TAP 226(+020 | H | 22 | 3.5 | 8 | 1.8 |

| AVX Part No. | Case Size | Capacitance μF | DCL (μA) Max. | DF % Max. | ESR Max. (Ω) @ 100 kHz |
|---|-----------|---------------------------|----------------------------|-----------|---------------------------------|
| 20 volt @ 85°C (13 volt @ 125°C) continued | | | | | |
| TAP 336(+020 | J | 33 | 5.2 | 8 | 1.4 |
| TAP 476(+020 | K | 47 | 7.5 | 8 | 1.2 |
| TAP 686(+020 | N | 68 | 10.8 | 8 | 0.9 |
| TAP 107(+020 | N | 100 | 16.0 | 10 | 0.6 |
| 25 volt @ 85°C (16 volt @ 125°C) | | | | | |
| TAP 105(+025 | A | 1.0 | 0.5 | 4 | 10.0 |
| TAP 155(+025 | A | 1.5 | 0.5 | 4 | 8.0 |
| TAP 225(+025 | A | 2.2 | 0.5 | 6 | 6.0 |
| TAP 335(+025 | B | 3.3 | 0.6 | 6 | 5.0 |
| TAP 475(+025 | C | 4.7 | 0.9 | 6 | 4.0 |
| TAP 685(+025 | D | 6.8 | 1.3 | 6 | 3.1 |
| TAP 106(+025 | E | 10 | 2.0 | 8 | 2.5 |
| TAP 156(+025 | F | 15 | 3.0 | 8 | 2.0 |
| TAP 226(+025 | H | 22 | 4.4 | 8 | 1.5 |
| TAP 336(+025 | J | 33 | 6.6 | 8 | 1.2 |
| TAP 476(+025 | M | 47 | 9.4 | 8 | 1.0 |
| TAP 686(+025 | N | 68 | 13.6 | 8 | 0.8 |
| 35 volt @ 85°C (23 volt @ 125°C) | | | | | |
| TAP 104(+035 | A | 0.1 | 0.5 | 4 | 26.0 |
| TAP 154(+035 | A | 0.15 | 0.5 | 4 | 21.0 |
| TAP 224(+035 | A | 0.22 | 0.5 | 4 | 17.0 |
| TAP 334(+035 | A | 0.33 | 0.5 | 4 | 15.0 |
| TAP 474(+035 | A | 0.47 | 0.5 | 4 | 13.0 |
| TAP 684(+035 | A | 0.68 | 0.5 | 4 | 10.0 |
| TAP 105(+035 | A | 1.0 | 0.5 | 4 | 8.0 |
| TAP 155(+035 | A | 1.5 | 0.5 | 4 | 6.0 |
| TAP 225(+035 | B | 2.2 | 0.6 | 6 | 5.0 |
| TAP 335(+035 | C | 3.3 | 0.9 | 6 | 4.0 |
| TAP 475(+035 | E | 4.7 | 1.3 | 6 | 3.0 |
| TAP 685(+035 | F | 6.8 | 1.9 | 6 | 2.5 |
| TAP 106(+035 | F | 10 | 2.8 | 8 | 2.0 |
| TAP 156(+035 | H | 15 | 4.2 | 8 | 1.6 |
| TAP 226(+035 | K | 22 | 6.1 | 8 | 1.3 |
| TAP 336(+035 | M | 33 | 9.2 | 8 | 1.0 |
| TAP 476(+035 | N | 47 | 10.0 | 8 | 0.8 |
| 50 volt @ 85°C (33 volt @ 125°C) | | | | | |
| TAP 104(+050 | A | 0.1 | 0.5 | 4 | 26.0 |
| TAP 154(+050 | A | 0.15 | 0.5 | 4 | 21.0 |
| TAP 224(+050 | A | 0.22 | 0.5 | 4 | 17.0 |
| TAP 334(+050 | A | 0.33 | 0.5 | 4 | 15.0 |
| TAP 474(+050 | A | 0.47 | 0.5 | 4 | 13.0 |
| TAP 684(+050 | B | 0.68 | 0.5 | 4 | 10.0 |
| TAP 105(+050 | C | 1.0 | 0.5 | 4 | 8.0 |
| TAP 155(+050 | D | 1.5 | 0.6 | 4 | 6.0 |
| TAP 225(+050 | E | 2.2 | 0.8 | 6 | 3.5 |
| TAP 335(+050 | F | 3.3 | 1.3 | 6 | 3.0 |
| TAP 475(+050 | G | 4.7 | 1.8 | 6 | 2.5 |
| TAP 685(+050 | H | 6.8 | 2.7 | 6 | 2.0 |
| TAP 106(+050 | J | 10 | 4.0 | 8 | 1.6 |
| TAP 156(+050 | K | 15 | 6.0 | 8 | 1.2 |
| TAP 226(+050 | L | 22 | 8.8 | 8 | 1.0 |

(*) Insert capacitance tolerance code; M for $\pm 20\%$, K for $\pm 10\%$ and J for $\pm 5\%$

NOTE: Voltage ratings are minimum values. AVX reserves the right to supply higher voltage ratings in the same case size.

Dipped Radial Capacitors



Tape and Reel Packaging

SOLID TANTALUM RESIN DIPPED TAP/TEP

TAPE AND REEL PACKAGING FOR AUTOMATIC COMPONENT INSERTION

TAP/TEP types are all offered on radial tape, in reel or 'ammo' pack format for use on high speed radial automatic insertion equipment, or preforming machines.

The tape format is compatible with EIA 468A standard for component taping set out by major manufacturers of radial automatic insertion equipment.

TAP/TEP – available in three formats. See page 101 for dimensions.



'B' wires for normal automatic insertion on 5mm pitch.

BRW suffix for reel
BRS suffix for 'ammo' pack
Available in case sizes A - J



'C' wires for preforming.

CRW suffix for reel
CRS suffix for 'ammo' pack
Available in case sizes A - R



'S' and 'D' wire for special applications, automatic insertion on 2.5mm pitch.

SRW, DTW suffix for reel
SRS, DTS suffix for 'ammo' pack
Available in case sizes A - J

Dipped Radial Capacitors



Tape and Reel Packaging

SOLID TANTALUM RESIN DIPPED TAP/TEP

CASE DIMENSIONS: millimeters (inches)

| Description | Code | Dimension |
|---------------------------------|----------------|--|
| Feed hole pitch | P | 12.7 ± 0.30 (0.500 ± 0.010) |
| Hole center to lead | P ₁ | 3.85 ± 0.70 (0.150 ± 0.030) to be measured at bottom of clench |
| | | 5.05 ± 1.00 (0.200 ± 0.040) for S wire |
| Hole center to component center | P ₂ | 6.35 ± 0.40 (0.250 ± 0.020) |
| Change in pitch | Δp | ± 1.00 (± 0.040) |
| Lead diameter | d | 0.50 ± 0.05 (0.020 ± 0.003) |
| Lead spacing | S | See wire form table |
| Component alignment | Δh | 0 ± 2.00 (0 ± 0.080) |
| Feed hole diameter | D | 4.00 ± 0.20 (0.150 ± 0.008) |
| Tape width | W | 18.0 + 1.00 (0.700 + 0.040) - 0.50 - 0.020) |
| Hold down tape width | W ₁ | 6.00 (0.240) min. |
| Hold down tape position | W ₂ | 1.00 (0.040) max. |
| Lead wire clench height | H | 16.0 ± 0.50 (0.630 ± 0.020) |
| | | 19.0 ± 1.00 (0.750 ± 0.040) on request |
| Hole position | H ₁ | 9.00 ± 0.50 (0.350 ± 0.020) |
| Base of component height | H ₂ | 18.0 (0.700) min. (S wire only) |
| Component height | H ₃ | 32.25 (1.300) max. |
| Length of snipped lead | L | 11.0 (0.430) max. |
| Total tape thickness | T | 0.70 ± 0.20 (0.030 ± 0.001) |
| | | Carrying card 0.50 ± 0.10 (0.020 ± 0.005) |

REEL CONFIGURATION AND DIMENSIONS: millimeters (inches)

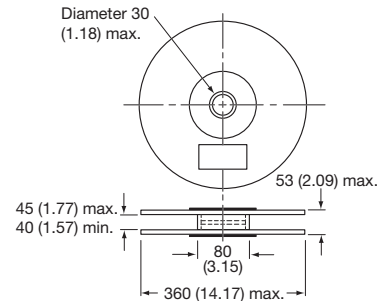

Manufactured from cardboard with plastic hub.

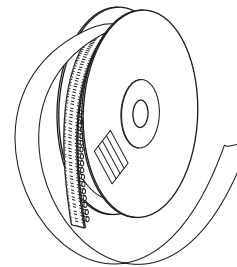

Holding tape outside. Positive terminal leading.

PACKAGING QUANTITIES

For Reels

| Style | Case size | No. of pieces |
|------------|------------------|---------------|
| TAP TEP | A | 1500 |
| | B, C, D | 1250 |
| | E, F | 1000 |
| | G, H, J | 750 |
| | K, L, M, N, P, R | 500 |

For 'Ammo' pack

| Style | Case size | No. of pieces |
|------------|------------------|---------------|
| TAP TEP | A, B, C, D | 3000 |
| | E, F, G | 2500 |
| | H, J | 2000 |
| | K, L, M, N, P, R | 1000 |

For bulk products

| Style | Case size | No. of pieces |
|------------|-----------|---------------|
| TAP TEP | A to H | 1000 |
| | J to L | 500 |
| | M to R | 100 |

AMMO PACK DIMENSIONS

millimeters (inches) max.

Height 360 (14.17), width 360 (14.17), thickness 60 (2.36)

GENERAL NOTES

Resin dipped tantalum capacitors are only available taped in the range of case sizes and in the modular quantities by case size as indicated.

Packaging quantities on tape may vary by ±1%.

TAP/TEP Technical Summary and Application Guidelines



SECTION 1: ELECTRICAL CHARACTERISTICS AND EXPLANATION OF TERMS

1.1 CAPACITANCE

1.1.1 Rated capacitance (C_R)

This is the nominal rated capacitance. For tantalum capacitors it is measured as the capacitance of the equivalent series circuit at 20°C in a measuring bridge supplied by a 120 Hz source free of harmonics with 2.2V DC bias max.

1.1.2 Temperature dependence on the capacitance

The capacitance of a tantalum capacitor varies with temperature. This variation itself is dependent to a small extent on the rated voltage and capacitor size. See graph below for typical capacitance changes with temperature.

Typical Capacitance vs. Temperature

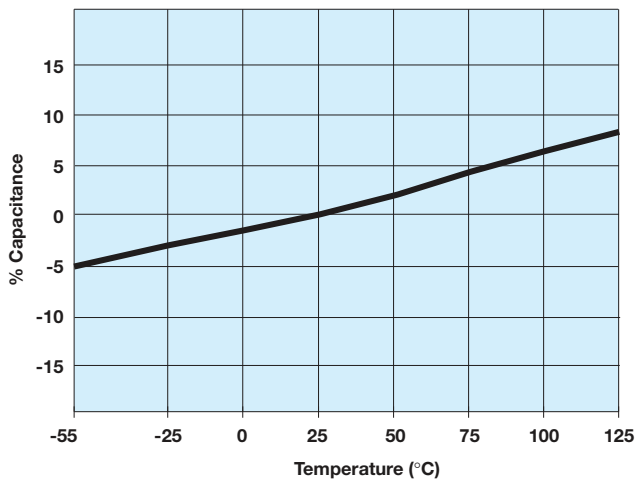

1.1.3 Capacitance tolerance

This is the permissible variation of the actual value of the capacitance from the rated value.

1.1.4 Frequency dependence of the capacitance

The effective capacitance decreases as frequency increases. Beyond 100 kHz the capacitance continues to drop until resonance is reached (typically between 0.5-5 MHz depending on the rating). Beyond this the device becomes inductive.

Typical Curve Capacitance vs. Frequency

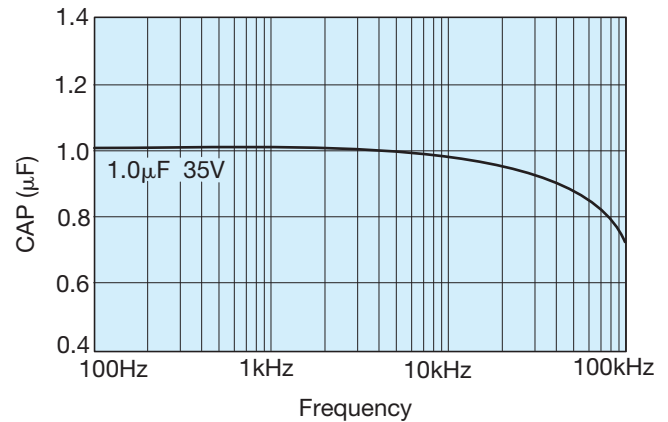

1.2 VOLTAGE

1.2.1 Rated DC voltage (V_R)

This is the rated DC voltage for continuous operation up to +85°C.

1.2.2 Category voltage (V_C)

This is the maximum voltage that may be applied continuously to a capacitor. It is equal to the rated voltage up to +85°C, beyond which it is subject to a linear derating, to 2/3 V_R at 125°C.

1.2.3 Surge voltage (V_S)

This is the highest voltage that may be applied to a capacitor for short periods of time. The surge voltage may be applied up to 10 times in an hour for periods of up to 30 seconds at a time. The surge voltage must not be used as a parameter in the design of circuits in which, in the normal course of operation, the capacitor is periodically charged and discharged.

Category Voltage vs. Temperature

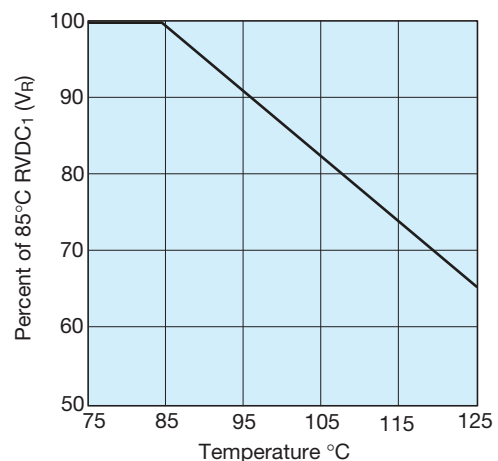

TAP/TEP Technical Summary and Application Guidelines



| 85°C | | 125°C | |
|----------------------|----------------------|-------------------------|----------------------|
| Rated Voltage (V DC) | Surge Voltage (V DC) | Category Voltage (V DC) | Surge Voltage (V DC) |
| 2 | 2.6 | 1.3 | 1.7 |
| 3 | 4 | 2 | 2.6 |
| 4 | 5.2 | 2.6 | 3.4 |
| 6.3 | 8 | 4 | 5 |
| 10 | 13 | 6.3 | 9 |
| 16 | 20 | 10 | 12 |
| 20 | 26 | 13 | 16 |
| 25 | 33 | 16 | 21 |
| 35 | 46 | 23 | 28 |
| 50 | 65 | 33 | 40 |

1.2.4 Effect of surges

The solid Tantalum capacitor has a limited ability to withstand surges (15% to 30% of rated voltage). This is in common with all other electrolytic capacitors and is due to the fact that they operate under very high electrical stress within the oxide layer. In the case of 'solid' electrolytic capacitors this is further complicated by the limited self healing ability of the manganese dioxide semiconductor.

It is important to ensure that the voltage across the terminals of the capacitor does not exceed the surge voltage rating at any time. This is particularly so in low impedance circuits where the capacitor is likely to be subjected to the full impact of surges, especially in low inductance applications. Even an extremely short duration spike is likely to cause damage. In such situations it will be necessary to use a higher voltage rating.

1.3 DISSIPATION FACTOR AND TANGENT OF LOSS ANGLE (TAN D)

1.3.1 Dissipation factor (DF)

Dissipation factor is the measurement of the tangent of the loss angle ($\tan \delta$) expressed as a percentage.

The measurement of DF is carried out at +25°C and 120 Hz with 2.2V DC bias max. with an AC voltage free of harmonics. The value of DF is temperature and frequency dependent.

1.3.2 Tangent of loss angle ($\tan \delta$)

This is a measure of the energy loss in the capacitor. It is expressed as $\tan \delta$ and is the power loss of the capacitor divided by its reactive power at a sinusoidal voltage of specified frequency. (Terms also used are power factor, loss factor and dielectric loss, $\cos(90 - \delta)$ is the true power factor.) The measurement of $\tan \delta$ is carried out at +20°C and 120 Hz with 2.2V DC bias max. with an AC voltage free of harmonics.

1.2.5 Reverse voltage and non-polar operation

The reverse voltage ratings are designed to cover exceptional conditions of small level excursions into incorrect polarity. The values quoted are not intended to cover continuous reverse operation.

The peak reverse voltage applied to the capacitor must not exceed:

- 10% of rated DC working voltage to a maximum of 1V at 25°C

- 3% of rated DC working voltage to a maximum of 0.5V at 85°C

- 1% of category DC working voltage to a maximum of 0.1V at 125°C

1.2.6 Non-polar operation

If the higher reverse voltages are essential, then two capacitors, each of twice the required capacitance and of equal tolerance and rated voltage, should be connected in a back-to-back configuration, i.e., both anodes or both cathodes joined together. This is necessary in order to avoid a reduction in life expectancy.

1.2.7 Superimposed AC voltage (V_{rms}) - Ripple Voltage

This is the maximum RMS alternating voltage, superimposed on a DC voltage, that may be applied to a capacitor. The sum of the DC voltage and the surge value of the superimposed AC voltage must not exceed the category voltage, V_C . Full details are given in Section 2.

1.2.8 Voltage derating

Refer to section 3.2 (pages 136-138) for the effect of voltage derating on reliability.

1.3.3 Frequency dependence of dissipation factor

Dissipation Factor increases with frequency as shown in the typical curves below.

Typical Curve-Dissipation Factor vs. Frequency

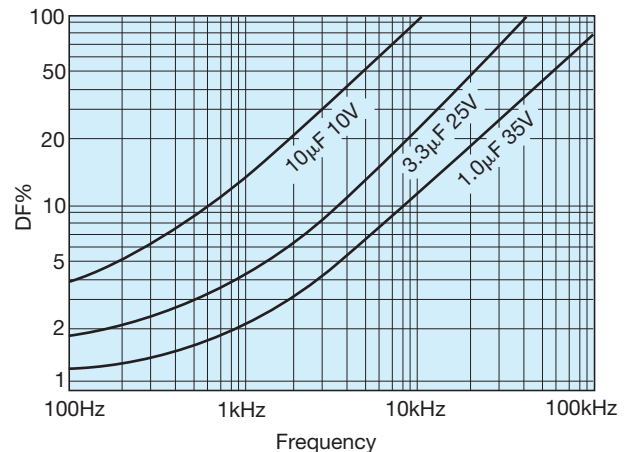

TAP/TEP Technical Summary and Application Guidelines



1.3.4 Temperature dependence of dissipation factor

Dissipation factor varies with temperature as the typical curves show to the right. For maximum limits please refer to ratings tables.

Typical Curves-Dissipation Factor vs. Temperature

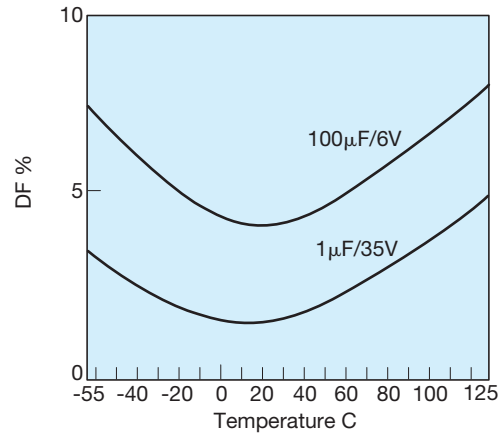

1.4 IMPEDANCE, (Z) AND EQUIVALENT SERIES RESISTANCE (ESR)

1.4.1 Impedance, Z

This is the ratio of voltage to current at a specified frequency. Three factors contribute to the impedance of a tantalum capacitor; the resistance of the semiconducting layer, the capacitance, and the inductance of the electrodes and leads.

At high frequencies the inductance of the leads becomes a limiting factor. The temperature and frequency behavior of these three factors of impedance determine the behavior of the impedance Z. The impedance is measured at 25°C and 100 kHz.

1.4.2 Equivalent series resistance, ESR

Resistance losses occur in all practical forms of capacitors. These are made up from several different mechanisms, including resistance in components and contacts, viscous forces within the dielectric, and defects producing bypass current paths. To express the effect of these losses they are considered as the ESR of the capacitor. The ESR is frequency dependent. The ESR can be found by using the relationship:

$$ESR = \frac{\tan \delta}{2\pi f C}$$

where f is the frequency in Hz, and C is the capacitance in farads. The ESR is measured at 25°C and 100 kHz.

ESR is one of the contributing factors to impedance, and at high frequencies (100 kHz and above) is the dominant factor, so that ESR and impedance become almost identical, impedance being marginally higher.

1.4.3 Frequency dependence of impedance and ESR

ESR and impedance both increase with decreasing frequency. At lower frequencies the values diverge as the extra contributions to impedance (resistance of the semiconducting layer, etc.) become more significant. Beyond 1 MHz (and beyond the resonant point of the capacitor) impedance again increases due to induction.

Frequency Dependence of Impedance and ESR

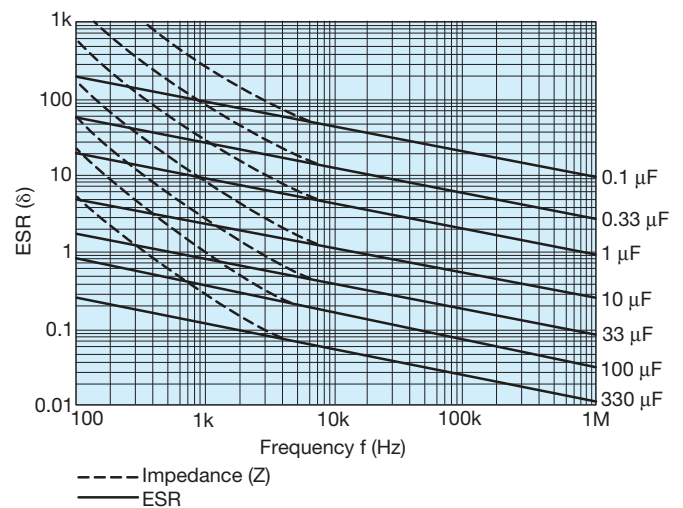

TAP/TEP Technical Summary and Application Guidelines



1.4.4 Temperature dependence of the impedance and ESR

At 100 kHz, impedance and ESR behave identically and decrease with increasing temperature as the typical curves show. For maximum limits at high and low temperatures, please refer to graph opposite.



1.5 DC LEAKAGE CURRENT (DCL)

1.5.1 Leakage current (DCL)

The leakage current is dependent on the voltage applied, the time, and the capacitor temperature. It is measured at +25°C with the rated voltage applied. A protective resistance of 1000Ω is connected in series with the capacitor in the measuring circuit.

Three minutes after application of the rated voltage the leakage current must not exceed the maximum values indicated in the ratings table. Reforming is unnecessary even after prolonged periods without the application of voltage.

1.5.2 Temperature dependence of the leakage current

The leakage current increases with higher temperatures, typical values are shown in the graph.

For operation between 85°C and 125°C, the maximum working voltage must be derated and can be found from the following formula.

$$V_{\max} = \left(1 - \frac{T-85}{120}\right) \times V_R \text{ volts}$$

where T is the required operating temperature. Maximum limits are given in rating tables.

1.5.3 Voltage dependence of the leakage current

The leakage current drops rapidly below the value corresponding to the rated voltage V_R when reduced voltages are applied. The effect of voltage derating on the leakage current is shown in the graph.

This will also give a significant increase in reliability for any application. See Section 3 (pages 137-138) for details.

1.5.4 Ripple current

The maximum ripple current allowance can be calculated from the power dissipation limits for a given temperature rise above ambient. Please refer to Section 2 (page 135) for details.

Temperature Dependence of the Leakage Current for a Typical Component

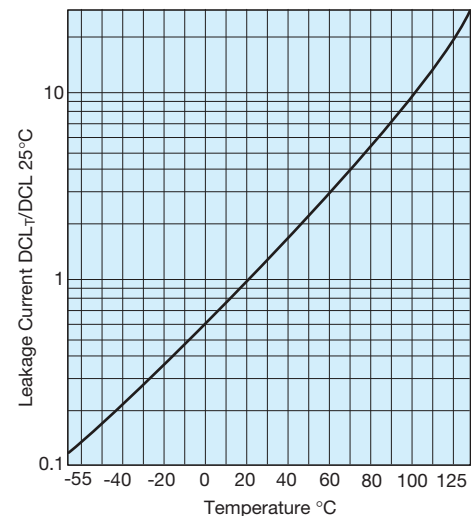

Effect of Voltage Derating on Leakage Current

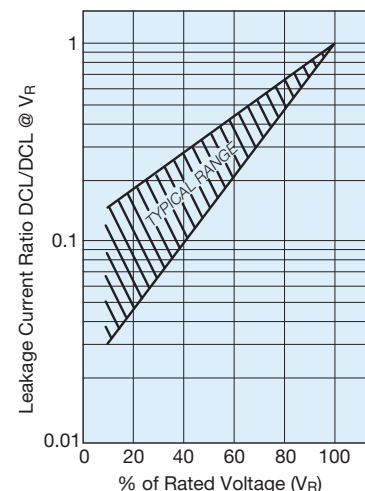

TAP/TEP Technical Summary and Application Guidelines



SECTION 2: AC OPERATION — RIPPLE VOLTAGE AND RIPPLE CURRENT

2.1 RIPPLE RATINGS (AC)

In an AC application heat is generated within the capacitor by both the AC component of the signal (which will depend upon signal form, amplitude and frequency), and by the DC leakage. For practical purposes the second factor is insignificant. The actual power dissipated in the capacitor is calculated using the formula:

$$P = I^2 R = \frac{E^2 R}{Z^2}$$

- I = rms ripple current, amperes
- R = equivalent series resistance, ohms
- E = rms ripple voltage, volts
- P = power dissipated, watts
- Z = impedance, ohms, at frequency under consideration

Using this formula it is possible to calculate the maximum AC ripple current and voltage permissible for a particular application.

2.2 MAXIMUM AC RIPPLE VOLTAGE (E_{MAX})

From the previous equation:

$$E_{(max)} = Z \sqrt{\frac{P_{max}}{R}}$$

where P_{max} is the maximum permissible ripple voltage as listed for the product under consideration (see table).

However, care must be taken to ensure that:

1. The DC working voltage of the capacitor must not be exceeded by the sum of the positive peak of the applied AC voltage and the DC bias voltage.
2. The sum of the applied DC bias voltage and the negative peak of the AC voltage must not allow a voltage reversal in excess of that defined in the sector, 'Reverse Voltage'.

2.3 MAXIMUM PERMISSIBLE POWER DISSIPATION (WATTS) @ 25°C

The maximum power dissipation at 25°C has been calculated for the various series and are shown in Section 2.4, together with temperature derating factors up to 125°C.

For leaded components the values are calculated for parts supported in air by their leads (free space dissipation).

The ripple ratings are set by defining the maximum temperature rise to be allowed under worst case conditions, i.e., with resistive losses at their maximum limit. This differential is normally 10°C at room temperature dropping to 2°C at 125°C. In application circuit layout, thermal management, available ventilation, and signal waveform may significantly

affect the values quoted below. It is recommended that temperature measurements are made on devices during operating conditions to ensure that the temperature differential between the device and the ambient temperature is less than 10°C up to 85°C and less than 2°C between 85°C and 125°C. Derating factors for temperatures above 25°C are also shown below. The maximum permissible proven dissipation should be multiplied by the appropriate derating factor.

For certain applications, e.g., power supply filtering, it may be desirable to obtain a screened level of ESR to enable higher ripple currents to be handled. Please contact our applications desk for information.

2.4 POWER DISSIPATION RATINGS (IN FREE AIR)

TAR – Molded Axial

| Case size | Max. power dissipation (W) | Temperature derating factors | |
|-----------|----------------------------|------------------------------|--------|
| | | Temp. °C | Factor |
| Q | 0.065 | +25 | 1.0 |
| R | 0.075 | +85 | 0.6 |
| S | 0.09 | +125 | 0.4 |
| W | 0.105 | | |

TAA – Hermetically Sealed Axial

| Case size | Max. power dissipation (W) | Temperature derating factors | |
|-----------|----------------------------|------------------------------|--------|
| | | Temp. °C | Factor |
| A | 0.09 | +20 | 1.0 |
| B | 0.10 | +85 | 0.9 |
| C | 0.125 | +125 | 0.4 |
| D | 0.18 | | |

TAP/TEP – Resin Dipped Radial

| Case size | Max. power dissipation (W) | Temperature derating factors | |
|-----------|----------------------------|------------------------------|--------|
| | | Temp. °C | Factor |
| A | 0.045 | +25 | 1.0 |
| B | 0.05 | +85 | 0.4 |
| C | 0.055 | +125 | 0.09 |
| D | 0.06 | | |
| E | 0.065 | | |
| F | 0.075 | | |
| G | 0.08 | | |
| H | 0.085 | | |
| J | 0.09 | | |
| K | 0.1 | | |
| L | 0.11 | | |
| M/N | 0.12 | | |
| P | 0.13 | | |
| R | 0.14 | | |



TAP/TEP Technical Summary and Application Guidelines



SECTION 3: RELIABILITY AND CALCULATION OF FAILURE RATE

3.1 STEADY-STATE

Tantalum Dielectric has essentially no wear out mechanism and in certain circumstances is capable of limited self healing, random failures can occur in operation. The failure rate of Tantalum capacitors will decrease with time and not increase as with other electrolytic capacitors and other electronic components.

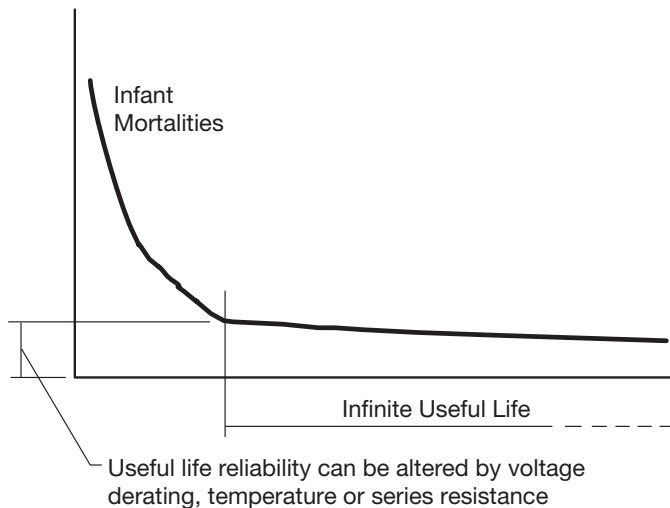

Figure 1. Tantalum reliability curve.

The useful life reliability of the Tantalum capacitor is affected by three factors. The equation from which the failure rate can be calculated is:

$$F = F_U \times F_T \times F_R \times F_B$$

where F_U is a correction factor due to operating voltage/voltage derating

F_T is a correction factor due to operating temperature

F_R is a correction factor due to circuit series resistance

F_B is the basic failure rate level. For standard leaded Tantalum product this is 1%/1000hours

Operating voltage/voltage derating

If a capacitor with a higher voltage rating than the maximum line voltage is used, then the operating reliability will be improved. This is known as voltage derating. The graph, Figure 2, shows the relationship between voltage derating (the ratio between applied and rated voltage) and the failure rate. The graph gives the correction factor F_U for any operating voltage.

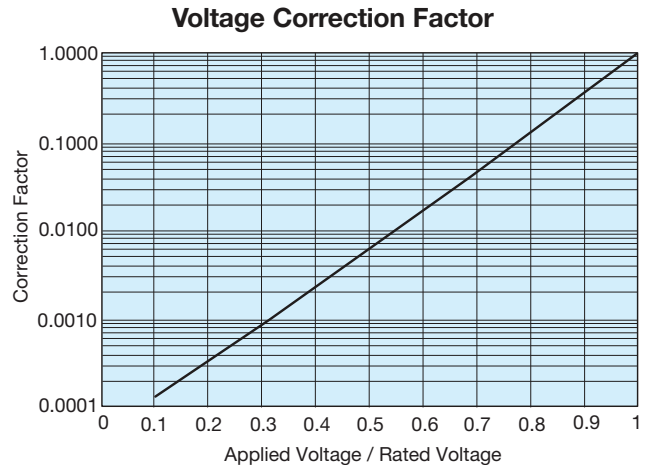

Figure 2. Correction factor to failure rate F for voltage derating of a typical component (60% con. level).

Operating temperature

If the operating temperature is below the rated temperature for the capacitor then the operating reliability will be improved as shown in Figure 3. This graph gives a correction factor F_T for any temperature of operation.



Figure 3. Correction factor to failure rate F for ambient temperature T for typical component (60% con. level).

TAP/TEP Technical Summary and Application Guidelines



Circuit Impedance

All solid tantalum capacitors require current limiting resistance to protect the dielectric from surges. A series resistor is recommended for this purpose. A lower circuit impedance may cause an increase in failure rate, especially at temperatures higher than 20°C. An inductive low impedance circuit may apply voltage surges to the capacitor and similarly a non-inductive circuit may apply current surges to the capacitor, causing localized over-heating and failure. The recommended impedance is 1Ω per volt. Where this is not feasible, equivalent voltage derating should be used (See MIL HANDBOOK 217E). Table I shows the correction factor, F_R , for increasing series resistance.

Table I: Circuit Impedance

Correction factor to failure rate F for series resistance R on basic failure rate F_B for a typical component (60% con. level).

| Circuit Resistance ohms/volt | FR |
|------------------------------|------|
| 3.0 | 0.07 |
| 2.0 | 0.1 |
| 1.0 | 0.2 |
| 0.8 | 0.3 |
| 0.6 | 0.4 |
| 0.4 | 0.6 |
| 0.2 | 0.8 |
| 0.1 | 1.0 |

Example calculation

Consider a 12 volt power line. The designer needs about 10μF of capacitance to act as a decoupling capacitor near a video bandwidth amplifier. Thus the circuit impedance will be limited only by the output impedance of the boards power unit and the track resistance. Let us assume it to be about 2 Ohms minimum, i.e., 0.167 Ohms/Volt. The operating temperature range is -25°C to +85°C. If a 10μF 16 Volt capacitor was designed-in, the operating failure rate would be as follows:

- a) $F_T = 0.8 @ 85^\circ\text{C}$
- b) $F_R = 0.7 @ 0.167 \text{ Ohms/Volt}$
- c) $F_U = 0.17 @ \text{applied voltage/rated voltage} = 75\%$

Thus $F_B = 0.8 \times 0.7 \times 0.17 \times 1 = 0.0952\%/1000 \text{ Hours}$

If the capacitor was changed for a 20 volt capacitor, the operating failure rate will change as shown.

$F_U = 0.05 @ \text{applied voltage/rated voltage} = 60\%$

$F_B = 0.8 \times 0.7 \times 0.05 \times 1 = 0.028\%/1000 \text{ Hours}$

3.2 DYNAMIC

As stated in Section 1.2.4 (page 132), the solid Tantalum capacitor has a limited ability to withstand voltage and current surges. Such current surges can cause a capacitor to fail. The expected failure rate cannot be calculated by a simple formula as in the case of steady-state reliability. The two parameters under the control of the circuit design engineer known to reduce the incidence of failures are derating and series resistance. The table below summarizes the results of trials carried out at AVX with a piece of equipment which has very low series resistance and applied no derating. So that the capacitor was tested at its rated voltage.

Results of production scale derating experiment

| Capacitance and Voltage | Number of units tested | 50% derating applied | No derating applied |
|-------------------------|------------------------|----------------------|---------------------|
| 47μF 16V | 1,547,587 | 0.03% | 1.1% |
| 100μF 10V | 632,876 | 0.01% | 0.5% |
| 22μF 25V | 2,256,258 | 0.05% | 0.3% |

As can clearly be seen from the results of this experiment, the more derating applied by the user, the less likely the probability of a surge failure occurring.

It must be remembered that these results were derived from a highly accelerated surge test machine, and failure rates in the low ppm are more likely with the end customer.

TAP/TEP Technical Summary and Application Guidelines



A commonly held misconception is that the leakage current of a Tantalum capacitor can predict the number of failures which will be seen on a surge screen. This can be disproved by the results of an experiment carried out at AVX on 47µF 10V surface mount capacitors with different leakage currents. The results are summarized in the table below.

Leakage Current vs Number of Surge Failures

| | Number tested | Number failed surge |
|---|---------------|---------------------|
| Standard leakage range 0.1 µA to 1µA | 10,000 | 25 |
| Over Catalog limit 5µA to 50µA | 10,000 | 26 |
| Classified Short Circuit 50µA to 500µA | 10,000 | 25 |

Again, it must be remembered that these results were derived from a highly accelerated surge test machine, and failure rates in the low ppm are more likely with the end customer.

AVX recommended derating table

| Voltage Rail | Working Cap Voltage |
|--------------|--------------------------|
| 3.3 | 6.3 |
| 5 | 10 |
| 10 | 20 |
| 12 | 25 |
| 15 | 35 |
| ≥24 | Series Combinations (11) |

For further details on surge in Tantalum capacitors refer to J.A. Gill's paper "Surge in Solid Tantalum Capacitors", available from AVX offices worldwide.

An added bonus of increasing the derating applied in a circuit, to improve the ability of the capacitor to withstand surge conditions, is that the steady-state reliability is improved by up to an order. Consider the example of a 6.3 volt capacitor being used on a 5 volt rail. The steady-state reliability of a Tantalum capacitor is affected by three parameters; temperature, series resistance and voltage derating. Assuming 40°C operation and 0.1Ω/volt of series resistance, the scaling factors for temperature and series resistance will both be 0.05 [see Section 3.1 (page 136)]. The derating factor will be 0.15. The capacitors reliability will therefore be

$$\begin{aligned} \text{Failure rate} &= F_U \times F_T \times F_R \times 1\%/1000 \text{ hours} \\ &= 0.15 \times 0.05 \times 1 \times 1\%/1000 \text{ hours} \\ &= 7.5\% \times 10^{-3}/\text{hours} \end{aligned}$$

If a 10 volt capacitor was used instead, the new scaling factor would be 0.017, thus the steady-state reliability would be

$$\begin{aligned} \text{Failure rate} &= F_U \times F_T \times F_R \times 1\%/1000 \text{ hours} \\ &= 0.017 \times 0.05 \times 1 \times 1\%/1000 \text{ hours} \\ &= 8.5\% \times 10^{-4}/1000 \text{ hours} \end{aligned}$$

So there is an order improvement in the capacitors steady-state reliability.

3.3 RELIABILITY TESTING

AVX performs extensive life testing on tantalum capacitors.

- 2,000 hour tests as part of our regular Quality Assurance Program.

Test conditions:

- 85°C/rated voltage/circuit impedance of 3Ω max.
- 125°C/0.67 x rated voltage/circuit impedance of 3Ω max.

3.4 Mode of Failure

This is normally an increase in leakage current which ultimately becomes a short circuit.

TAP/TEP Technical Summary and Application Guidelines



SECTION 4: APPLICATION GUIDELINES FOR TANTALUM CAPACITORS

4.1 SOLDERING CONDITIONS AND BOARD ATTACHMENT

The soldering temperature and time should be the minimum for a good connection.

A suitable combination for wavesoldering is 230°C - 250°C for 3 - 5 seconds.

Small parametric shifts may be noted immediately after wave solder, components should be allowed to stabilize at room temperature prior to electrical testing.

AVX leaded tantalum capacitors are designed for wave soldering operations.

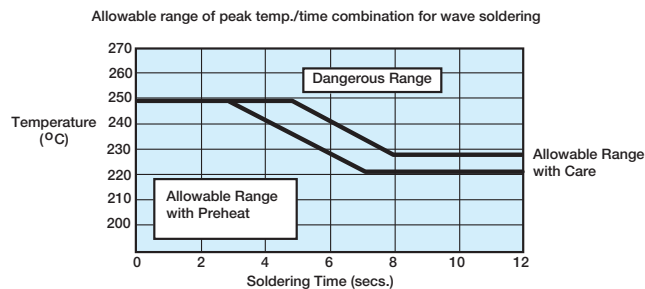

4.2 RECOMMENDED SOLDERING PROFILES

Recommended wave soldering profile for mounting of tantalum capacitors is shown below.

After soldering the assembly should preferably be allowed to cool naturally. In the event that assisted cooling is used, the rate of change in temperature should not exceed that used in reflow.

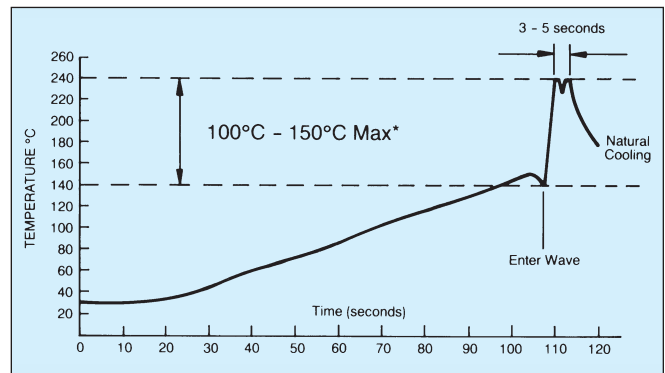

*See appropriate product specification

SECTION 5: MECHANICAL AND THERMAL PROPERTIES, LEADED CAPACITORS

5.1 ACCELERATION

10 g (981 m/s)

5.2 VIBRATION SEVERITY

10 to 2000 Hz, 0.75 mm or 98 m/s²

5.3 SHOCK

Trapezoidal Pulse 10 g (981 m/s) for 6 ms

5.4 TENSILE STRENGTH OF CONNECTION

10 N for type TAR, 5 N for type TAP/TEP.

5.5 BENDING STRENGTH OF CONNECTIONS

2 bends at 90°C with 50% of the tensile strength test loading.

5.6 SOLDERING CONDITIONS

Dip soldering permissible provided solder bath temperature $\leq 270^\circ\text{C}$; solder time < 3 sec.; circuit board thickness ≤ 1.0 mm.

5.7 INSTALLATION INSTRUCTIONS

The upper temperature limit (maximum capacitor surface temperature) must not be exceeded even under the most unfavorable conditions when the capacitor is installed. This must be considered particularly when it is positioned near components which radiate heat strongly (e.g., valves and power transistors). Furthermore, care must be taken, when bending the wires, that the bending forces do not strain the capacitor housing.

5.8 INSTALLATION POSITION

No restriction.

5.9 SOLDERING INSTRUCTIONS

Fluxes containing acids must not be used.



Компания «Океан Электроники» предлагает заключение долгосрочных отношений при поставках импортных электронных компонентов на взаимовыгодных условиях!

Наши преимущества:

- Поставка оригинальных импортных электронных компонентов напрямую с производств Америки, Европы и Азии, а так же с крупнейших складов мира;
- Широкая линейка поставок активных и пассивных импортных электронных компонентов (более 30 млн. наименований);
- Поставка сложных, дефицитных, либо снятых с производства позиций;
- Оперативные сроки поставки под заказ (от 5 рабочих дней);
- Экспресс доставка в любую точку России;
- Помощь Конструкторского Отдела и консультации квалифицированных инженеров;
- Техническая поддержка проекта, помощь в подборе аналогов, поставка прототипов;
- Поставка электронных компонентов под контролем ВП;
- Система менеджмента качества сертифицирована по Международному стандарту ISO 9001;
- При необходимости вся продукция военного и аэрокосмического назначения проходит испытания и сертификацию в лаборатории (по согласованию с заказчиком);
- Поставка специализированных компонентов военного и аэрокосмического уровня качества (Xilinx, Altera, Analog Devices, Intersil, Interpoint, Microsemi, Actel, Aeroflex, Peregrine, VPT, Syfer, Eurofarad, Texas Instruments, MS Kennedy, Miteq, Cobham, E2V, MA-COM, Hittite, Mini-Circuits, General Dynamics и др.);

Компания «Океан Электроники» является официальным дистрибьютором и эксклюзивным представителем в России одного из крупнейших производителей разъемов военного и аэрокосмического назначения «JONHON», а так же официальным дистрибьютором и эксклюзивным представителем в России производителя высокотехнологичных и надежных решений для передачи СВЧ сигналов «FORSTAR».



JONHON

«JONHON» (основан в 1970 г.)

Разъемы специального, военного и аэрокосмического назначения:

(Применяются в военной, авиационной, аэрокосмической, морской, железнодорожной, горно- и нефтедобывающей отраслях промышленности)

«FORSTAR» (основан в 1998 г.)

ВЧ соединители, коаксиальные кабели, кабельные сборки и микроволновые компоненты:

(Применяются в телекоммуникациях гражданского и специального назначения, в средствах связи, РЛС, а так же военной, авиационной и аэрокосмической отраслях промышленности).



Телефон: 8 (812) 309-75-97 (многоканальный)

Факс: 8 (812) 320-03-32

Электронная почта: ocean@oceanchips.ru

Web: <http://oceanchips.ru/>

Адрес: 198099, г. Санкт-Петербург, ул. Калинина, д. 2, корп. 4, лит. А