

**PKU 4000 series DC/DC Converters**  
 Input 36 - 75 V, Output up to 25 A / 50 W

EN/LZT 146 308 R5A      November 2017

© Flex

### Key Features

- Industry standard Sixteenth-brick  
33.02 x 22.86 x 9.90 mm (1.3 x 0.9 x 0.39 in.)
- Wide output adjust, e.g. 3.3V +10/-40%
- 1500 Vdc input to output isolation
- Meets isolation requirements equivalent to basic insulation according to IEC/EN/UL 60950-1
- More than 3.5 million hours MTBF

### General Characteristics

- Pre-biased start-up capability
- Output over voltage protection
- Input under voltage shut-down
- Over temperature protection
- Monotonic start-up
- Output short-circuit protection
- Remote sense
- Remote control
- Output voltage adjust function
- Highly automated manufacturing ensures quality
- ISO 9001/14001 certified supplier



### Safety Approvals



### Design for Environment



Meets requirements in high-temperature lead-free soldering processes.

### Contents

Ordering Information	2
General Information	2
Safety Specification	3
Absolute Maximum Ratings	4
Product Program	Ordering No.
1.2V, 25A / 30W	PKU 4318L ..... 5
1.5V, 25A / 37.5W	PKU 4318H..... 9
1.8V, 25A / 45W	PKU 4418G ..... 13
2.5V, 15A / 37.5W	PKU 4319 ..... 17
3.3V, 15A / 50W	PKU 4510 ..... 21
5.0V, 10A / 50W	PKU 4511 ..... 25
12.0V, 4.2A / 50W	PKU 4513 ..... 29
15.0V, 3.3A / 50W	PKU 4515 ..... 33
EMC Specification	37
Operating Information	38
Thermal Consideration	40
Connections	41
Mechanical Information	43
Soldering Information	45
Delivery Information	45
Product Qualification Specification	46

**PKU 4000 series DC/DC Converters**  
Input 36 - 75 V, Output up to 25 A / 50 W

EN/LZT 146 308 R5A November 2017

© Flex

### Ordering Information

Product program	Output
PKU 4318L	1.2 V, 25 A / 30 W
PKU 4318H	1.5 V, 25 A / 38 W
PKU 4418G	1.8 V, 25 A / 45 W
PKU 4319	2.5 V, 15 A / 38 W
PKU 4510	3.3 V, 15 A / 50 W
PKU 4511	5.0 V, 10 A / 50 W
PKU 4513	12 V, 4.2 A / 50 W
PKU 4515	15 V, 3.3 A / 50 W

### Product number and Packaging

PKU 4XXXX n <sub>1</sub> n <sub>2</sub> n <sub>3</sub> n <sub>4</sub>				
Options	n <sub>1</sub>	n <sub>2</sub>	n <sub>3</sub>	n <sub>4</sub>
Mounting	o			
Remote Control logic		o		
Lead length			o	
Delivery package information				o

Options	Description
n <sub>1</sub>	PI Through hole SI Surface mount
n <sub>2</sub>	Negative * P Positive
n <sub>3</sub>	5.30 mm * LA 3.69 mm LB 4.57 mm
n <sub>4</sub>	/B Tray /C Tape and Reel (only for surface mount products)

Example a through-hole mounted, negative logic, short pin product with tray packaging would be PKU 4510 PILA/B.

\* Standard variant (i.e. no option selected).

### General Information

#### Reliability

The failure rate ( $\lambda$ ) and mean time between failures (MTBF =  $1/\lambda$ ) is calculated at max output power and an operating ambient temperature ( $T_A$ ) of +40°C. Flex uses Telcordia SR-332 Issue 2 Method 1 to calculate the mean steady-state failure rate and standard deviation ( $\sigma$ ).

Telcordia SR-332 Issue 2 also provides techniques to estimate the upper confidence levels of failure rates based on the mean and standard deviation.

Mean steady-state failure rate, $\lambda$	Std. deviation, $\sigma$
283 nFailures/h	37.7 nFailures/h

MTBF (mean value) for the PKU series = 3.5 Mh.  
MTBF at 90% confidence level = 3.0 Mh

### Compatibility with RoHS requirements

The products are compatible with the relevant clauses and requirements of the RoHS directive 2002/95/EC and have a maximum concentration value of 0.1% by weight in homogeneous materials for lead, mercury, hexavalent chromium, PBB and PBDE and of 0.01% by weight in homogeneous materials for cadmium.

Exemptions in the RoHS directive utilized in Flex products include:

- Lead in high melting temperature type solder (used to solder the die in semiconductor packages)
- Lead in glass of electronics components and in electronic ceramic parts (e.g. fill material in chip resistors)
- Lead as an alloying element in copper alloy containing up to 4% lead by weight (used in connection pins made of Brass)

### Quality Statement

The products are designed and manufactured in an industrial environment where quality systems and methods like ISO 9000, 6 $\sigma$  (sigma), and SPC are intensively in use to boost the continuous improvements strategy. Infant mortality or early failures in the products are screened out and they are subjected to an ATE-based final test. Conservative design rules, design reviews and product qualifications, plus the high competence of an engaged work force, contribute to the high quality of our products.

### Warranty

Warranty period and conditions are defined in Flex General Terms and Conditions of Sale.

### Limitation of Liability

Flex does not make any other warranties, expressed or implied including any warranty of merchantability or fitness for a particular purpose (including, but not limited to, use in life support applications, where malfunctions of product can cause injury to a person's health or life).

### © Flex 2017

The information and specifications in this technical specification is believed to be correct at the time of publication. However, no liability is accepted for inaccuracies, printing errors or for any consequences thereof. Flex reserves the right to change the contents of this technical specification at any time without prior notice.

**PKU 4000 series DC/DC Converters**  
Input 36 - 75 V, Output up to 25 A / 50 W

EN/LZT 146 308 R5A November 2017

© Flex

## Safety Specification

### General information

Flex DC/DC converters and DC/DC regulators are designed in accordance with safety standards IEC/EN/UL 60950-1 *Safety of Information Technology Equipment*.

IEC/EN/UL 60950-1 contains requirements to prevent injury or damage due to the following hazards:

- Electrical shock
- Energy hazards
- Fire
- Mechanical and heat hazards
- Radiation hazards
- Chemical hazards

On-board DC/DC converters and DC/DC regulators are defined as component power supplies. As components they cannot fully comply with the provisions of any safety requirements without "Conditions of Acceptability". Clearance between conductors and between conductive parts of the component power supply and conductors on the board in the final product must meet the applicable safety requirements. Certain conditions of acceptability apply for component power supplies with limited stand-off (see Mechanical Information for further information). It is the responsibility of the installer to ensure that the final product housing these components complies with the requirements of all applicable safety standards and regulations for the final product.

Component power supplies for general use should comply with the requirements in IEC 60950-1, EN 60950-1 and UL 60950-1 *Safety of Information Technology Equipment*. There are other more product related standards, e.g. IEEE 802.3 *CSMA/CD (Ethernet) Access Method*, and ETS-300132-2 *Power supply interface at the input to telecommunications equipment, operated by direct current (dc)*, but all of these standards are based on IEC/EN/UL 60950-1 with regards to safety.

Flex DC/DC converters and DC/DC regulators are UL 60950-1 recognized and certified in accordance with EN 60950-1.

The flammability rating for all construction parts of the products meet requirements for V-0 class material according to IEC 60695-11-10, *Fire hazard testing, test flames* – 50 W horizontal and vertical flame test methods.

The products should be installed in the end-use equipment, in accordance with the requirements of the ultimate application. Normally the output of the DC/DC converter is considered as SELV (Safety Extra Low Voltage) and the input source must be isolated by minimum Double or Reinforced Insulation from the primary circuit (AC mains) in accordance with IEC/EN/UL 60950-1.

### Isolated DC/DC converters

It is recommended that a slow blow fuse is to be used at the input of each DC/DC converter. If an input filter is used in the circuit the fuse should be placed in front of the input filter.

In the rare event of a component problem that imposes a short circuit on the input source, this fuse will provide the following functions:

- Isolate the fault from the input power source so as not to affect the operation of other parts of the system.
- Protect the distribution wiring from excessive current and power loss thus preventing hazardous overheating.

The galvanic isolation is verified in an electric strength test. The test voltage ( $V_{iso}$ ) between input and output is 1500 Vdc or 2250 Vdc (refer to product specification).

### 24 V DC systems

The input voltage to the DC/DC converter is SELV (Safety Extra Low Voltage) and the output remains SELV under normal and abnormal operating conditions.

### 48 and 60 V DC systems

If the input voltage to the DC/DC converter is 75 Vdc or less, then the output remains SELV (Safety Extra Low Voltage) under normal and abnormal operating conditions.

Single fault testing in the input power supply circuit should be performed with the DC/DC converter connected to demonstrate that the input voltage does not exceed 75 Vdc.

If the input power source circuit is a DC power system, the source may be treated as a TNV-2 circuit and testing has demonstrated compliance with SELV limits in accordance with IEC/EN/UL60950-1.

### Non-isolated DC/DC regulators

The input voltage to the DC/DC regulator is SELV (Safety Extra Low Voltage) and the output remains SELV under normal and abnormal operating conditions.

**PKU 4000 series DC/DC Converters**  
 Input 36 - 75 V, Output up to 25 A / 50 W

EN/LZT 146 308 R5A November 2017  
 © Flex

**Absolute Maximum Ratings**

Characteristics		min	typ	max	Unit
$T_{P1}$	Operating Temperature (see Thermal Consideration section)	-45		+120	°C
$T_S$	Storage temperature	-55		+125	°C
$V_I$	Input voltage	-0.5		+80	V
$V_{iso}$	Isolation voltage (input to output test voltage)			1500	Vdc
$V_{tr}$	Input voltage transient ( $t_p$ 100 ms)			100	V
$V_{RC}$	Remote Control pin voltage (see Operating Information section)	Positive logic option		25	V
		Negative logic option	-0.5	25	V
$V_{adj}$	Adjust pin voltage (see Operating Information section)	-0.5		6	V

Stress in excess of Absolute Maximum Ratings may cause permanent damage. Absolute Maximum Ratings, sometimes referred to as no destruction limits, are normally tested with one parameter at a time exceeding the limits in the Electrical Specification. If exposed to stress above these limits, function and performance may degrade in an unspecified manner.

**Fundamental Circuit Diagram**

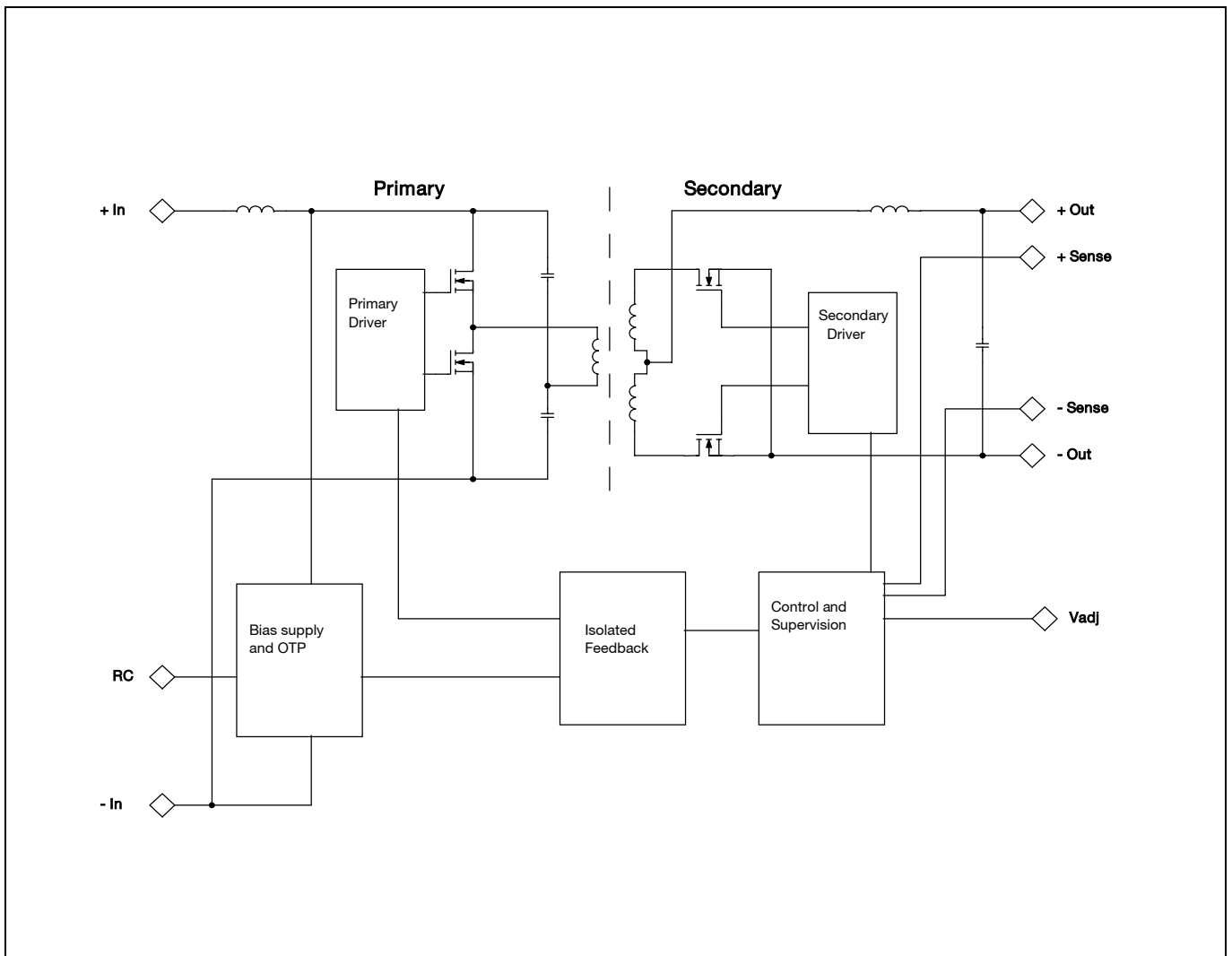

**PKU 4000 series DC/DC Converters**  
 Input 36 - 75 V, Output up to 25 A / 50 W

EN/LZT 146 308 R5A November 2017

© Flex

**Electrical Specification**  
**1.2 V, 25 A / 30 W**
**PKU 4318L PI**
 $T_{P1} = -30$  to  $+110^{\circ}\text{C}$ ,  $V_I = 36$  to  $75$  V, sense pins connected to output pins unless otherwise specified under Conditions.

 Typical values given at:  $T_{P1} = +25^{\circ}\text{C}$ ,  $V_I = 53$  V,  $I_O$  max, unless otherwise specified under Conditions.

 Additional  $C_{in} = 1 \mu\text{F}$ . See Operating Information section for selection of capacitor types.

Characteristics		Conditions	min	typ	max	Unit
$V_I$	Input voltage range		36		75	V
$V_{loff}$	Turn-off input voltage	Decreasing input voltage See Note 1	29	31	33	V
$V_{lon}$	Turn-on input voltage	Increasing input voltage See Note 1	32	33	34.5	V
$C_I$	Internal input capacitance			0.5		$\mu\text{F}$
$P_O$	Output power		0		30	W
$\eta$	Efficiency	50% of max $I_O$		83.5		%
		max $I_O$		82.5		
		50% of max $I_O$ , $V_I = 48$ V		84		
		max $I_O$ , $V_I = 48$ V		83		
$P_d$	Power Dissipation	max $I_O$		6.3	10	W
$P_{li}$	Input idling power	$I_O = 0$ A, $V_I = 53$ V		1.8		W
$P_{RC}$	Input standby power	$V_I = 53$ V (turned off with RC)		0.13		W
$f_s$	Switching frequency	0-100 % of max $I_O$	290	320	350	kHz

$V_{Oi}$	Output voltage initial setting and accuracy	$T_{P1} = +25^{\circ}\text{C}$ , $V_I = 53$ V, $I_O = 25$ A	1.176	1.20	1.224	V
$V_O$	Output adjust range	See operating information	1.00		1.32	V
	Output voltage tolerance band	0-100% of max $I_O$	1.16		1.24	V
	Idling voltage	$I_O = 0$ A	1.18		1.22	V
	Line regulation	max $I_O$		5	12	mV
	Load regulation	$V_I = 53$ V, 0-100% of max $I_O$		5	10	mV
$V_{tr}$	Load transient voltage deviation	$V_I = 53$ V, Load step 25-75-25% of max $I_O$ , $di/dt = 7$ A/ $\mu\text{s}$		$\pm 160$	$\pm 250$	mV
$t_{tr}$	Load transient recovery time			25	50	$\mu\text{s}$
$t_r$	Ramp-up time (from 10-90% of $V_{Oi}$ )	0-100% of max $I_O$	5	6	7	ms
$t_s$	Start-up time (from $V_I$ connection to 90% of $V_{Oi}$ )		9	10	11	ms
$t_f$	$V_I$ shut-down fall time (from $V_I$ off to 10% of $V_O$ )	max $I_O$	0.05	0.1	0.2	ms
		$I_O = 2.5$ A	0.0003	0.0007	0.001	s
$t_{RC}$	RC start-up time	max $I_O$		5		ms
	RC shut-down fall time (from RC off to 10% of $V_O$ )	max $I_O$		0.5		ms
		$I_O = 2.5$ A		0.0005		s
$I_O$	Output current		0		25	A
$I_{lim}$	Current limit threshold	$T_{P1} < \max T_{P1}$	26	31	35	A
$I_{sc}$	Short circuit current	$T_{P1} = 25^{\circ}\text{C}$ , see Note 2		20		A
$V_{Oac}$	Output ripple & noise	See ripple & noise section, $V_{Oi}$		70	130	mVp-p
OVP	Over voltage protection	$T_{P1} = +25^{\circ}\text{C}$ , $V_I = 53$ V, 0-100% of max $I_O$		1.55		V

Note 1: See Operation information section Turn-off Input Voltage.

 Note 2: RMS current in hiccup mode,  $V_O$  lower than approx 0.5V.

**PKU 4000 series DC/DC Converters**  
 Input 36 - 75 V, Output up to 25 A / 50 W

EN/LZT 146 308 R5A      November 2017  
 © Flex

### Typical Characteristics 1.2 V, 25 A / 30 W

**PKU 4318L PI**

#### Efficiency

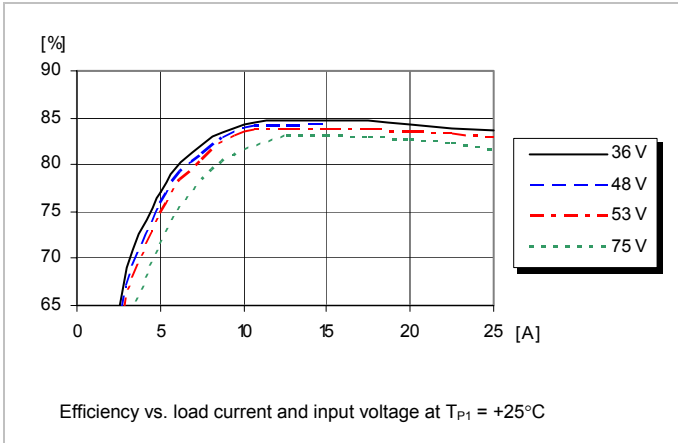

#### Power Dissipation

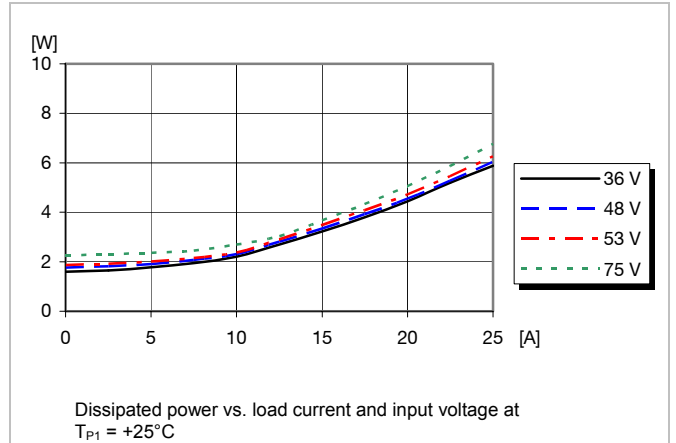

#### Output Characteristics

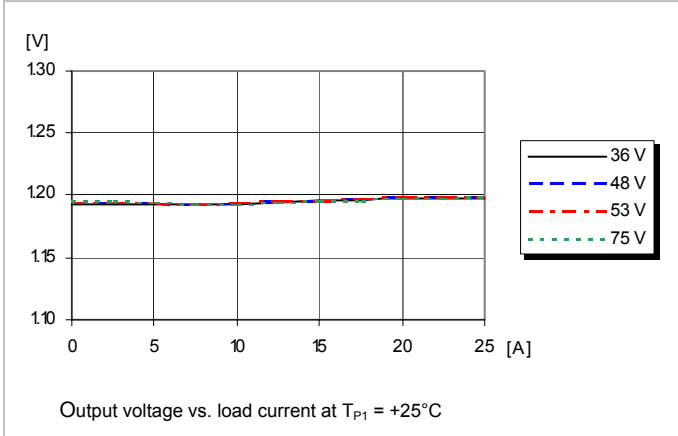

#### Current Limit Characteristics

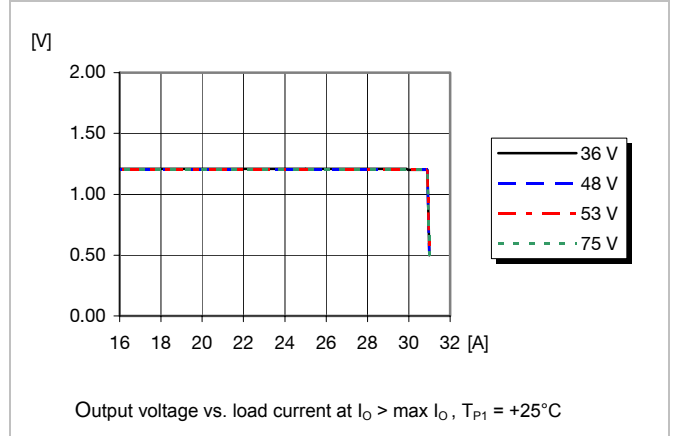

**PKU 4000 series DC/DC Converters**  
 Input 36 - 75 V, Output up to 25 A / 50 W

EN/LZT 146 308 R5A November 2017  
 © Flex

### Typical Characteristics 1.2 V, 25 A / 30 W

**PKU 4318L PI**

#### Start-up

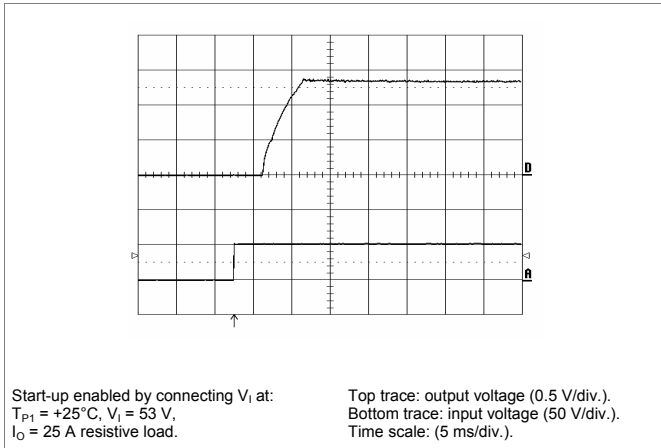

#### Shut-down

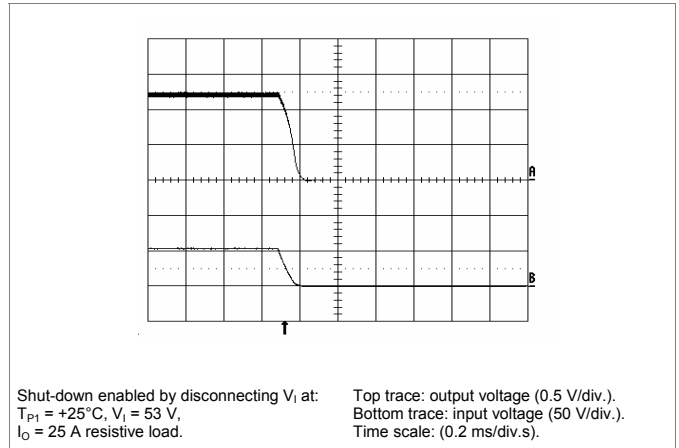

#### Output Ripple & Noise

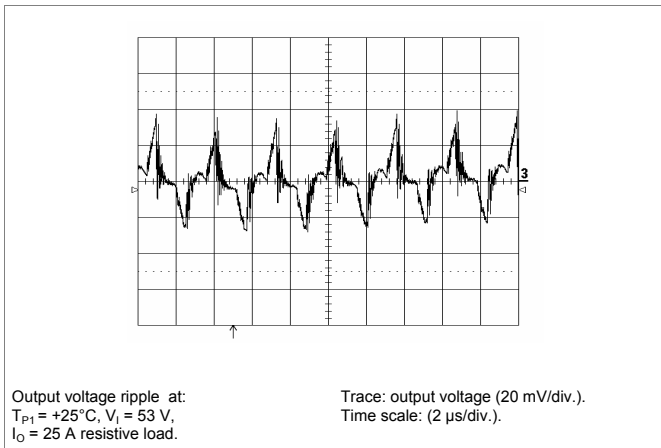

#### Output Load Transient Response

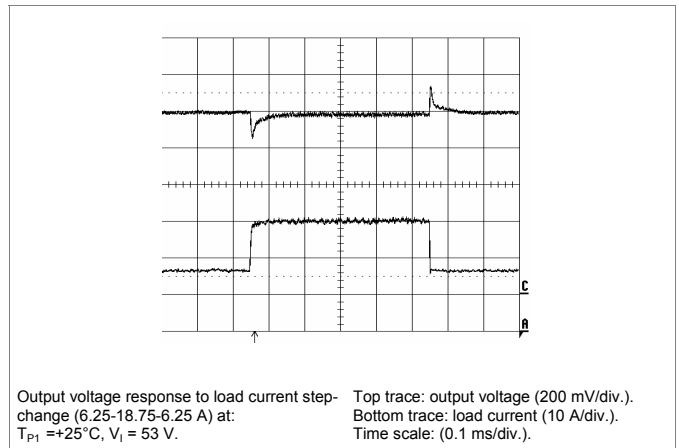

### Output Voltage Adjust (see operating information)

#### Passive adjust

The resistor value for an adjusted output voltage is calculated by using the following equations:

Output Voltage Adjust Upwards, Increase:

$$R_{adj} = \left( \frac{5.11 \times 1.20(100 + \Delta\%) }{0.6 \times \Delta\%} - \frac{511}{\Delta\%} - 10.22 \right) \text{ k}\Omega$$

Example: Increase 4% =>  $V_{out} = 1.248\text{ Vdc}$

$$\left( \frac{5.11 \times 1.20(100 + 4)}{0.6 \times 4} - \frac{511}{4} - 10.22 \right) \text{ k}\Omega = 128 \text{ k}\Omega$$

Output Voltage Adjust Downwards, Decrease:

$$R_{adj} = \left( \frac{511}{\Delta\%} \right) - 10.22 \text{ k}\Omega$$

Example: Decrease 2% =>  $V_{out} = 1.176\text{ Vdc}$

$$\left( \frac{511}{2} \right) - 10.22 \text{ k}\Omega = 245 \text{ k}\Omega$$

#### Active adjust

The output voltage may be adjusted using a voltage applied to the  $V_{adj}$  pin. This voltage is calculated by using the following equation:

$$V_{adj} = 5.11 \times \left( 0.118 + 0.235 \times \frac{V_{desired} - 1.20}{1.20} \right) \text{ V}$$

Example: Upwards => 1.30 V

$$5.11 \times \left( 0.118 + 0.235 \times \frac{1.30 - 1.20}{1.20} \right) \text{ V} = 0.70 \text{ V}$$

Example: Downwards => 1.0 V

$$5.11 \times \left( 0.118 + 0.235 \times \frac{1.0 - 1.20}{1.20} \right) \text{ V} = 0.40 \text{ V}$$

**PKU 4000 series DC/DC Converters**  
 Input 36 - 75 V, Output up to 25 A / 50 W

EN/LZT 146 308 R5A November 2017

© Flex

**Typical Characteristics**  
**1.2 V, 25 A / 30 W**

**PKU 4318L PI**

**Output Current Derating – Open frame**

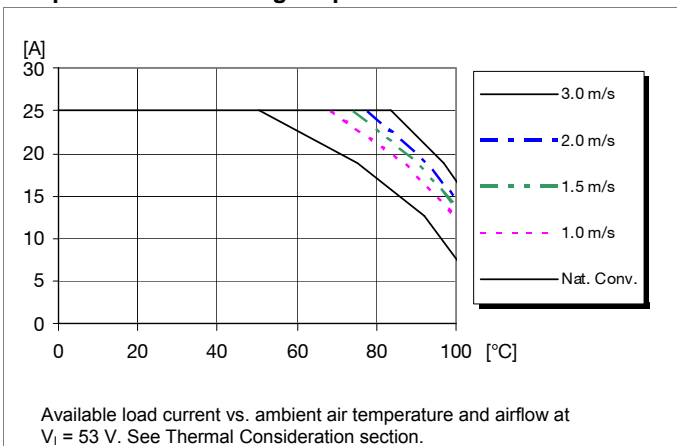



**PKU 4000 series DC/DC Converters**  
 Input 36 - 75 V, Output up to 25 A / 50 W

 EN/LZT 146 308 R5A November 2017  
 © Flex

**Electrical Specification**  
**1.5 V, 25 A / 37.5 W**
**PKU 4318H PI**

$T_{P1} = -30$  to  $+110^{\circ}\text{C}$ ,  $V_I = 36$  to  $75$  V, sense pins connected to output pins unless otherwise specified under Conditions.  
 Typical values given at:  $T_{P1} = +25^{\circ}\text{C}$ ,  $V_I = 53$  V,  $I_O$  max, unless otherwise specified under Conditions.  
 Additional  $C_{in} = 1 \mu\text{F}$ . See Operating Information section for selection of capacitor types.

Characteristics		Conditions	min	typ	max	Unit
$V_I$	Input voltage range		36		75	V
$V_{loff}$	Turn-off input voltage	Decreasing input voltage See Note 1	29	31	33	V
$V_{lon}$	Turn-on input voltage	Increasing input voltage See Note 1	32	33	34.5	V
$C_I$	Internal input capacitance			0.5		$\mu\text{F}$
$P_O$	Output power		0		37.5	W
$\eta$	Efficiency	50% of max $I_O$		86		%
		max $I_O$		85		
		50% of max $I_O$ , $V_I = 48$ V		86		
		max $I_O$ , $V_I = 48$ V		85		
$P_d$	Power Dissipation	max $I_O$		6.7	10	W
$P_{li}$	Input idling power	$I_O = 0$ A, $V_I = 53$ V		2		W
$P_{RC}$	Input standby power	$V_I = 53$ V (turned off with RC)		0.15		W
$f_s$	Switching frequency	0-100 % of max $I_O$	290	320	350	kHz

$V_{Oi}$	Output voltage initial setting and accuracy	$T_{P1} = +25^{\circ}\text{C}$ , $V_I = 53$ V, $I_O = 25$ A	1.47	1.50	1.53	V
$V_O$	Output adjust range	See operating information	1.00		1.65	V
	Output voltage tolerance band	0-100% of max $I_O$	1.455		1.545	V
	Idling voltage	$I_O = 0$ A	1.48		1.52	V
	Line regulation	max $I_O$		5	12	mV
	Load regulation	$V_I = 53$ V, 0-100% of max $I_O$		5	10	mV
$V_{tr}$	Load transient voltage deviation	$V_I = 53$ V, Load step 25-75-25% of max $I_O$ , $di/dt = 7$ A/ $\mu\text{s}$		$\pm 120$	$\pm 250$	mV
$t_{tr}$	Load transient recovery time			15	50	$\mu\text{s}$
$t_r$	Ramp-up time (from 10-90% of $V_{Oi}$ )	0-100% of max $I_O$	3.5	5	6	ms
$t_s$	Start-up time (from $V_I$ connection to 90% of $V_{Oi}$ )		7	9	10	ms
$t_f$	$V_I$ shut-down fall time (from $V_I$ off to 10% of $V_O$ )	max $I_O$	0.05	0.1	0.2	ms
		$I_O = 2.5$ A		0.0007		s
$t_{RC}$	RC start-up time	max $I_O$		5		ms
	RC shut-down fall time (from RC off to 10% of $V_O$ )	max $I_O$		0.6		ms
		$I_O = 2.5$ A		0.00065		s
$I_O$	Output current		0		25	A
$I_{lim}$	Current limit threshold	$T_{P1} < \max T_{P1}$	26	31	35	A
$I_{sc}$	Short circuit current	$T_{P1} = 25^{\circ}\text{C}$ , see Note 2		20		A
$V_{Oac}$	Output ripple & noise	See ripple & noise section, $V_{Oi}$		80	150	mVp-p
OVP	Over voltage protection	$T_{P1} = +25^{\circ}\text{C}$ , $V_I = 53$ V, 0-100% of max $I_O$		1.9		V

Note 1: See Operation information section Turn-off Input Voltage.

 Note 2: RMS current in hiccup mode,  $V_O$  lower than approx 0.5V.

**PKU 4000 series DC/DC Converters**  
 Input 36 - 75 V, Output up to 25 A / 50 W

EN/LZT 146 308 R5A November 2017  
 © Flex

### Typical Characteristics 1.5 V, 25 A / 37.5 W

**PKU 4318H PI**

#### Efficiency

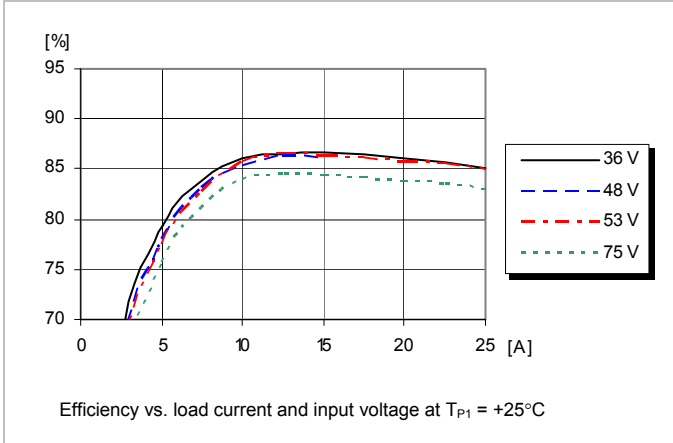

#### Power Dissipation

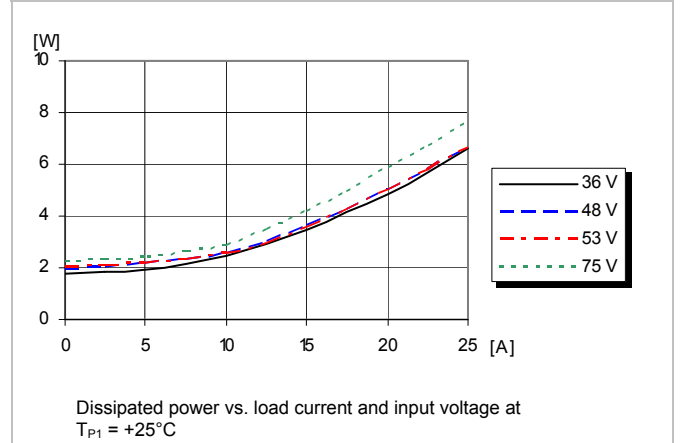

#### Output Characteristics

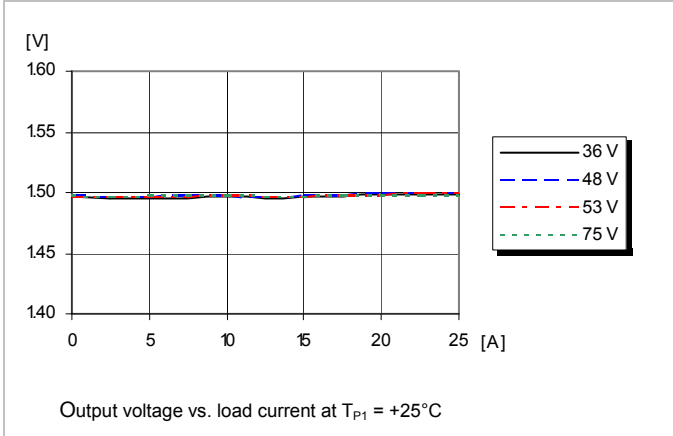

#### Current Limit Characteristics

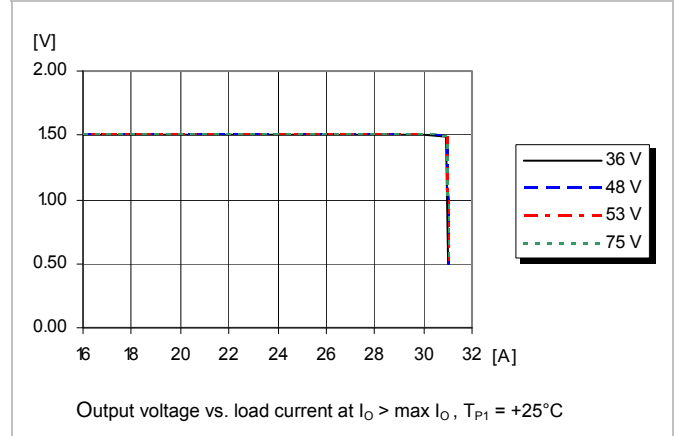

**PKU 4000 series DC/DC Converters**  
 Input 36 - 75 V, Output up to 25 A / 50 W

EN/LZT 146 308 R5A      November 2017  
 © Flex

### Typical Characteristics 1.5 V, 25 A / 37.5 W

**PKU 4318H PI**

#### Start-up

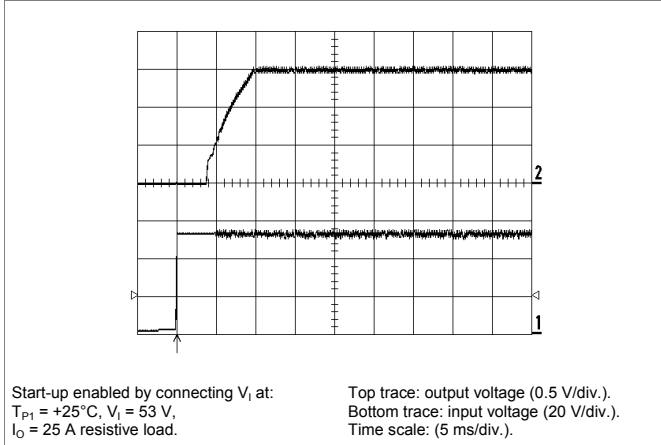

#### Shut-down

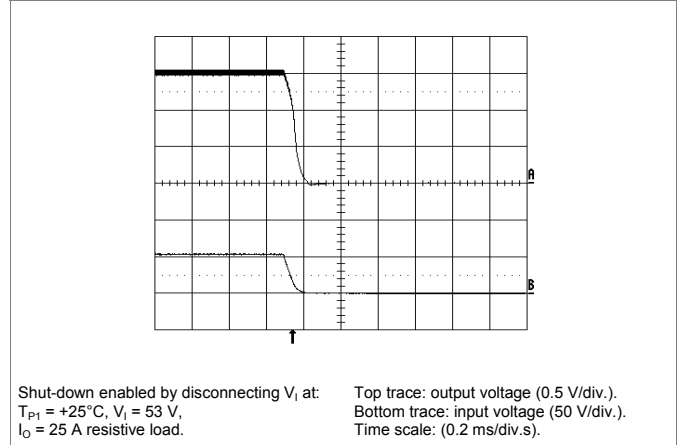

#### Output Ripple & Noise

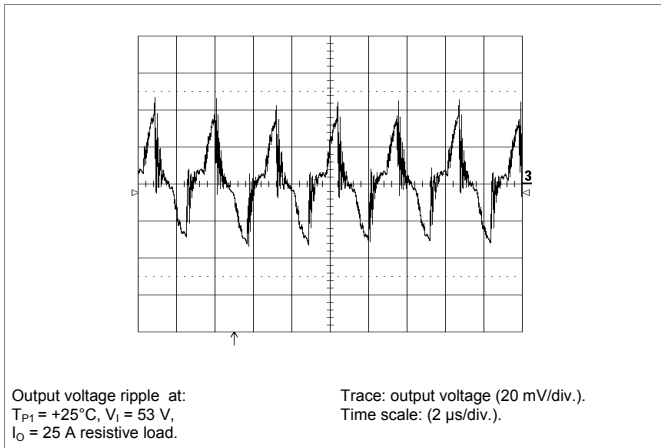

#### Output Load Transient Response

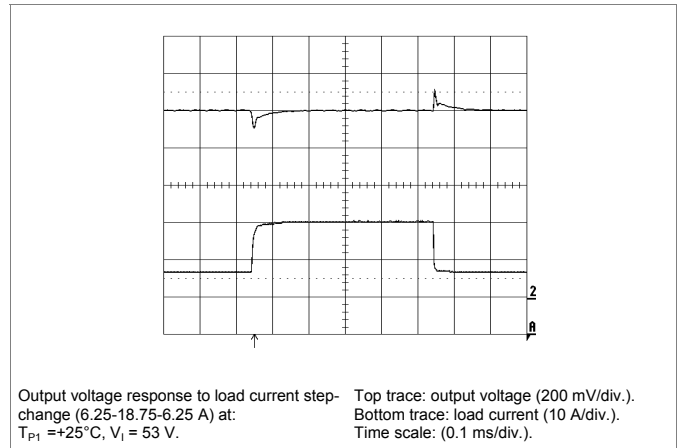

### Output Voltage Adjust (see operating information)

#### Passive adjust

The resistor value for an adjusted output voltage is calculated by using the following equations:

Output Voltage Adjust Upwards, Increase:

$$R_{adj} = \left( \frac{5.11 \times 1.50(100 + \Delta\%)}{1.225 \times \Delta\%} - \frac{511}{\Delta\%} - 10.22 \right) \text{ k}\Omega$$

Example: Increase 4% =>  $V_{out} = 1.56\text{ Vdc}$

$$\left( \frac{5.11 \times 1.50(100 + 4)}{1.225 \times 4} - \frac{511}{4} - 10.22 \right) \text{ k}\Omega = 24.7 \text{ k}\Omega$$

Output Voltage Adjust Downwards, Decrease:

$$R_{adj} = \left( \frac{511}{\Delta\%} \right) - 10.22 \text{ k}\Omega$$

Example: Decrease 2% =>  $V_{out} = 1.47\text{ Vdc}$

$$\left( \frac{511}{2} \right) - 10.22 \text{ k}\Omega = 245 \text{ k}\Omega$$

#### Active adjust

The output voltage may be adjusted using a voltage applied to the  $V_{adj}$  pin. This voltage is calculated by using the following equation:

$$V_{adj} = \left( 1.225 + 2.45 \times \frac{V_{desired} - 1.50}{1.50} \right) \text{ V}$$

Example: Upwards => 1.60 V

$$\left( 1.225 + 2.45 \times \frac{1.60 - 1.50}{1.50} \right) \text{ V} = 1.39 \text{ V}$$

Example: Downwards => 1.0 V

$$\left( 1.225 + 2.45 \times \frac{1.00 - 1.50}{1.50} \right) \text{ V} = 0.41 \text{ V}$$

**PKU 4000 series DC/DC Converters**  
 Input 36 - 75 V, Output up to 25 A / 50 W

EN/LZT 146 308 R5A

November 2017

© Flex

**Typical Characteristics**  
**1.5 V, 25 A / 37.5 W**

**PKU 4318H PI**

**Output Current Derating – Open frame**

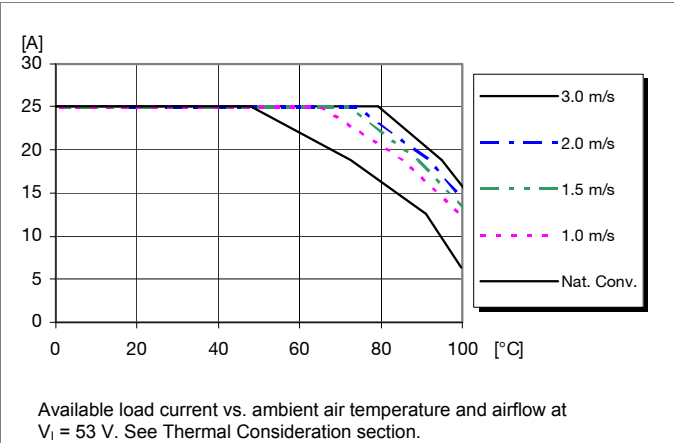

**PKU 4000 series DC/DC Converters**  
 Input 36 - 75 V, Output up to 25 A / 50 W

EN/LZT 146 308 R5A November 2017

© Flex

**Electrical Specification**  
**1.8 V, 25 A / 45 W**
**PKU 4418G PI**
 $T_{P1} = -30$  to  $+110^{\circ}\text{C}$ ,  $V_I = 36$  to  $75$  V, sense pins connected to output pins unless otherwise specified under Conditions.

 Typical values given at:  $T_{P1} = +25^{\circ}\text{C}$ ,  $V_I = 53$  V,  $I_O$  max, unless otherwise specified under Conditions.

 Additional  $C_{in} = 1 \mu\text{F}$ . See Operating Information section for selection of capacitor types.

Characteristics		Conditions	min	typ	max	Unit
$V_I$	Input voltage range		36		75	V
$V_{loff}$	Turn-off input voltage	Decreasing input voltage See Note 1	29	31	33	V
$V_{lon}$	Turn-on input voltage	Increasing input voltage See Note 1	32	33	34.5	V
$C_I$	Internal input capacitance			0.5		$\mu\text{F}$
$P_O$	Output power		0		45	W
$\eta$	Efficiency	50% of max $I_O$		86.4		%
		max $I_O$		86.0		
		50% of max $I_O$ , $V_I = 48$ V		86.8		
		max $I_O$ , $V_I = 48$ V		86.3		
$P_d$	Power Dissipation	max $I_O$		7.3	11.5	W
$P_{li}$	Input idling power	$I_O = 0$ A, $V_I = 53$ V		2.4		W
$P_{RC}$	Input standby power	$V_I = 53$ V (turned off with RC)		0.15		W
$f_s$	Switching frequency	0-100 % of max $I_O$	290	320	350	kHz

$V_{Oi}$	Output voltage initial setting and accuracy	$T_{P1} = +25^{\circ}\text{C}$ , $V_I = 53$ V, $I_O = 25$ A	1.764	1.800	1.836	V
$V_O$	Output adjust range	See operating information	1.00		1.98	V
	Output voltage tolerance band	0-100% of max $I_O$	1.75		1.85	V
	Idling voltage	$I_O = 0$ A	1.77		1.82	V
	Line regulation	max $I_O$		5	12	mV
	Load regulation	$V_I = 53$ V, 0-100% of max $I_O$		4	10	mV
$V_{tr}$	Load transient voltage deviation	$V_I = 53$ V, Load step 25-75-25% of max $I_O$ , $di/dt = 7$ A/ $\mu\text{s}$		$\pm 120$	$\pm 250$	mV
$t_{tr}$	Load transient recovery time			20	50	$\mu\text{s}$
$t_r$	Ramp-up time (from 10-90% of $V_{Oi}$ )	0-100% of max $I_O$	3.5	5	6	ms
$t_s$	Start-up time (from $V_I$ connection to 90% of $V_{Oi}$ )		7	9	10	ms
$t_f$	$V_I$ shut-down fall time (from $V_I$ off to 10% of $V_O$ )	max $I_O$	0.05	0.1	0.2	ms
		$I_O = 2.5$ A	0.0003	0.0007	0.001	s
$t_{RC}$	RC start-up time	max $I_O$		7		ms
	RC shut-down fall time (from RC off to 10% of $V_O$ )	max $I_O$		0.2		ms
		$I_O = 2.5$ A		0.0007		s
$I_O$	Output current		0		25	A
$I_{lim}$	Current limit threshold	$T_{P1} < \max T_{P1}$	26	31	35	A
$I_{sc}$	Short circuit current	$T_{P1} = 25^{\circ}\text{C}$ , see Note 2		20		A
$V_{Oac}$	Output ripple & noise	See ripple & noise section, $V_{Oi}$		85	150	mVp-p
OVP	Over voltage protection	$T_{P1} = +25^{\circ}\text{C}$ , $V_I = 53$ V, 0-100% of max $I_O$		2.2		V

Note 1: See Operation information section Turn-off Input Voltage.

 Note 2: RMS current in hiccup mode,  $V_O$  lower than approx 0.5V.

**PKU 4000 series DC/DC Converters**  
 Input 36 - 75 V, Output up to 25 A / 50 W

EN/LZT 146 308 R5A November 2017

© Flex

### Typical Characteristics 1.8 V, 25 A / 45 W

**PKU 4418G PI**

#### Efficiency

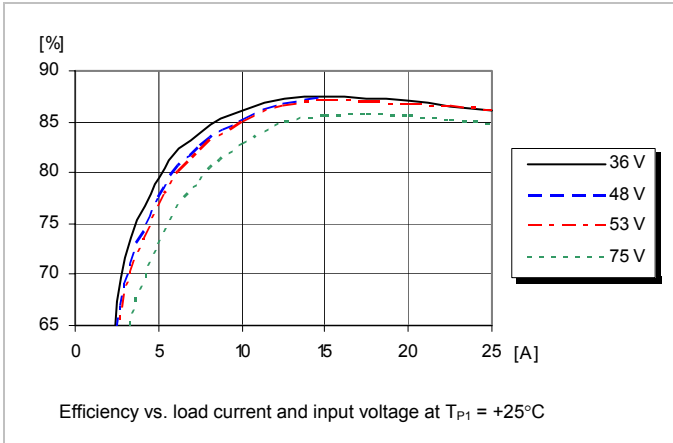

#### Power Dissipation

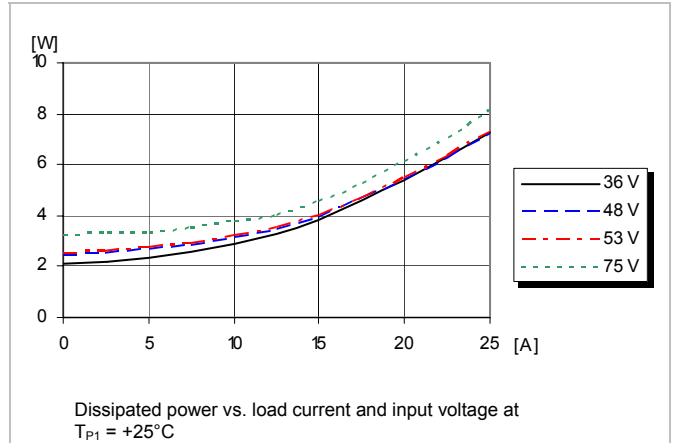

#### Output Characteristics

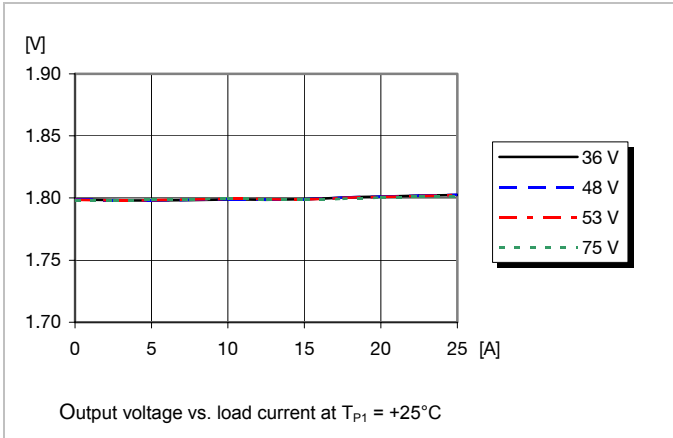

#### Current Limit Characteristics

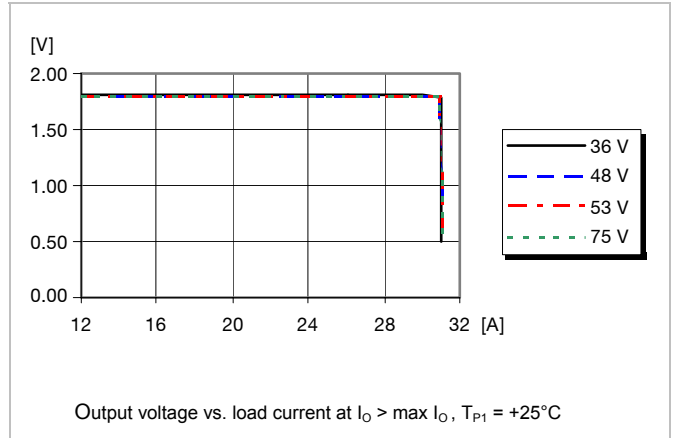

**PKU 4000 series DC/DC Converters**  
 Input 36 - 75 V, Output up to 25 A / 50 W

EN/LZT 146 308 R5A November 2017  
 © Flex

### Typical Characteristics 1.8 V, 25 A / 45 W

**PKU 4418G PI**

#### Start-up

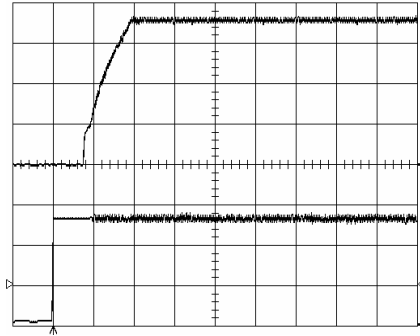

Start-up enabled by connecting  $V_1$  at:  
 $T_{P1} = +25^\circ\text{C}$ ,  $V_1 = 53\text{ V}$ ,  
 $I_O = 25\text{ A}$  resistive load.

Top trace: output voltage (0.5 V/div.).  
 Bottom trace: input voltage (20 V/div.).  
 Time scale: (5 ms/div.).

#### Shut-down

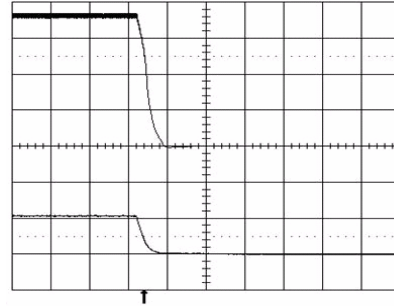

Shut-down enabled by disconnecting  $V_1$  at:  
 $T_{P1} = +25^\circ\text{C}$ ,  $V_1 = 53\text{ V}$ ,  
 $I_O = 25\text{ A}$  resistive load.

Top trace: output voltage (0.5 V/div.).  
 Bottom trace: input voltage (50 V/div.).  
 Time scale: (0.2 ms/div.s).

#### Output Ripple & Noise

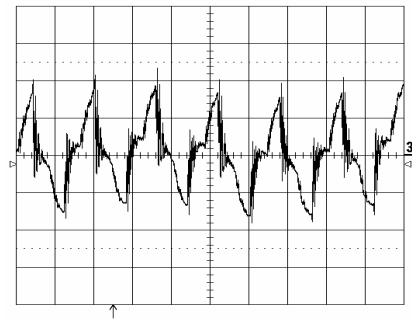

Output voltage ripple at:  
 $T_{P1} = +25^\circ\text{C}$ ,  $V_1 = 53\text{ V}$ ,  
 $I_O = 25\text{ A}$  resistive load.

Trace: output voltage (20 mV/div.).  
 Time scale: (2 μs/div.).

#### Output Load Transient Response

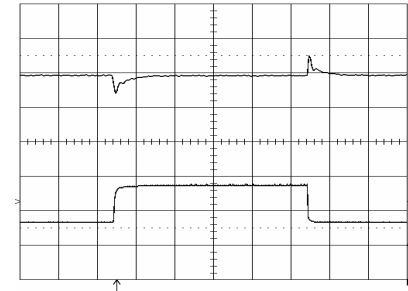

Output voltage response to load current step-change (6.25-18.75-6.25 A) at:  
 $T_{P1} = +25^\circ\text{C}$ ,  $V_1 = 53\text{ V}$ .

Top trace: output voltage (200 mV/div.).  
 Bottom trace: load current (10 A/div.).  
 Time scale: (0.1 ms/div.).

### Output Voltage Adjust (see operating information)

#### Passive adjust

The resistor value for an adjusted output voltage is calculated by using the following equations:

Output Voltage Adjust Upwards, Increase:

$$R_{adj} = \left( \frac{5.11 \times 1.80(100 + \Delta\%)}{1.225 \times \Delta\%} - \frac{511}{\Delta\%} - 10.22 \right) \text{ k}\Omega$$

Example: Increase 4% =>  $V_{out} = 1.872\text{ V}$

$$\left( \frac{5.11 \times 1.80(100 + 4)}{1.225 \times 4} - \frac{511}{4} - 10.22 \right) \text{ k}\Omega = 57\text{ k}\Omega$$

Output Voltage Adjust Downwards, Decrease:

$$R_{adj} = \left( \frac{511}{\Delta\%} \right) - 10.22\text{ k}\Omega$$

Example: Decrease 2% =>  $V_{out} = 1.764\text{ V}$

$$\left( \frac{511}{2} \right) - 10.22\text{ k}\Omega = 245\text{ k}\Omega$$

#### Active adjust

The output voltage may be adjusted using a voltage applied to the  $V_{adj}$  pin. This voltage is calculated by using the following equation:

$$V_{adj} = \left( 1.225 + 2.45 \times \frac{V_{desired} - 1.80}{1.80} \right) \text{ V}$$

Example: Upwards => 1.90 V

$$\left( 1.225 + 2.45 \times \frac{1.90 - 1.80}{1.80} \right) \text{ V} = 1.36\text{ V}$$

Example: Downwards => 1.0 V

$$\left( 1.225 + 2.45 \times \frac{1.00 - 1.80}{1.80} \right) \text{ V} = 0.14\text{ V}$$

**PKU 4000 series DC/DC Converters**  
 Input 36 - 75 V, Output up to 25 A / 50 W

EN/LZT 146 308 R5A      November 2017

© Flex

### Typical Characteristics 1.8 V, 25 A / 45 W

**PKU 4418G PI**

#### Output Current Derating – Open frame

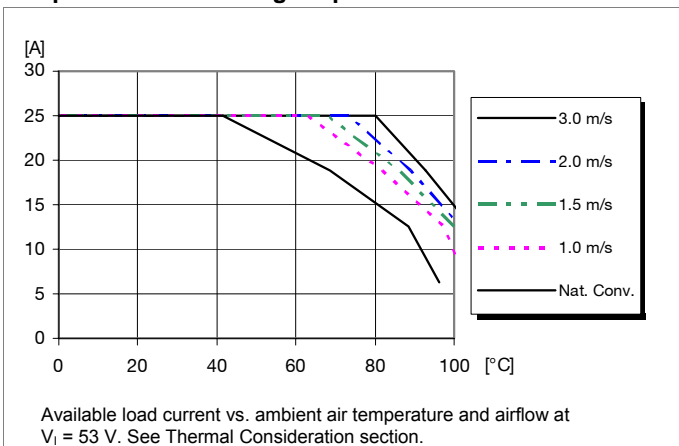



**PKU 4000 series DC/DC Converters**  
 Input 36 - 75 V, Output up to 25 A / 50 W

EN/LZT 146 308 R5A November 2017

© Flex

**Electrical Specification**  
**2.5 V, 15 A / 37.5 W**
**PKU 4319 PI**
 $T_{P1} = -30$  to  $+110^{\circ}\text{C}$ ,  $V_I = 36$  to  $75$  V, sense pins connected to output pins unless otherwise specified under Conditions.

 Typical values given at:  $T_{P1} = +25^{\circ}\text{C}$ ,  $V_I = 53$  V,  $I_O$  max, unless otherwise specified under Conditions.

 Additional  $C_{in} = 1 \mu\text{F}$ . See Operating Information section for selection of capacitor types.

Characteristics		Conditions	min	typ	max	Unit
$V_I$	Input voltage range		36		75	V
$V_{loff}$	Turn-off input voltage	Decreasing input voltage See Note 1	29	31	33	V
$V_{lon}$	Turn-on input voltage	Increasing input voltage See Note 1	32	33	34.5	V
$C_I$	Internal input capacitance			0.5		$\mu\text{F}$
$P_O$	Output power		0		37.5	W
$\eta$	Efficiency	50% of max $I_O$		88.0		%
		max $I_O$		87.3		
		50% of max $I_O$ , $V_I = 48$ V		88.7		
		max $I_O$ , $V_I = 48$ V		87.6		
$P_d$	Power Dissipation	max $I_O$		5.5	8.5	W
$P_{li}$	Input idling power	$I_O = 0$ A, $V_I = 53$ V		1.5		W
$P_{RC}$	Input standby power	$V_I = 53$ V (turned off with RC)		0.15		W
$f_s$	Switching frequency	0-100 % of max $I_O$	290	320	350	kHz

$V_{Oi}$	Output voltage initial setting and accuracy	$T_{P1} = +25^{\circ}\text{C}$ , $V_I = 53$ V, $I_O = 15$ A	2.45	2.50	2.55	V
$V_O$	Output adjust range	See operating information	1.90		3.00	V
	Output voltage tolerance band	0-100% of max $I_O$	2.42		2.58	V
	Idling voltage	$I_O = 0$ A	2.45		2.55	V
	Line regulation	max $I_O$		1	10	mV
	Load regulation	$V_I = 53$ V, 0-100% of max $I_O$		8	15	mV
$V_{tr}$	Load transient voltage deviation	$V_I = 53$ V, Load step 25-75-25% of max $I_O$ , $di/dt = 1$ A/ $\mu\text{s}$		$\pm 125$	$\pm 250$	mV
$t_{tr}$	Load transient recovery time			20	40	$\mu\text{s}$
$t_r$	Ramp-up time (from 10-90% of $V_{Oi}$ )	0-100% of max $I_O$	3.5	4.0	4.5	ms
$t_s$	Start-up time (from $V_I$ connection to 90% of $V_{Oi}$ )		7	8	9	ms
$t_f$	$V_I$ shut-down fall time (from $V_I$ off to 10% of $V_O$ )	max $I_O$	0.1	0.2	0.4	ms
		$I_O = 1.5$ A	0.0009	0.0013	0.0015	s
$t_{RC}$	RC start-up time	max $I_O$		6		ms
	RC shut-down fall time (from RC off to 10% of $V_O$ )	max $I_O$		1		ms
		$I_O = 1.5$ A		0.0015		s
$I_O$	Output current		0		15	A
$I_{lim}$	Current limit threshold	$T_{P1} < \text{max } T_{P1}$	16	18	22	A
$I_{sc}$	Short circuit current	$T_{P1} = 25^{\circ}\text{C}$ , see Note 2		13		A
$V_{Oac}$	Output ripple & noise	See ripple & noise section, $V_{Oi}$		55	100	mVp-p
OVP	Over voltage protection	$T_{P1} = +25^{\circ}\text{C}$ , $V_I = 53$ V, 0-100% of max $I_O$		3.35		V

Note 1: See Operation information section Turn-off Input Voltage.

 Note 2: RMS current in hiccup mode,  $V_O$  lower than approx 0.5V.

**PKU 4000 series DC/DC Converters**  
 Input 36 - 75 V, Output up to 25 A / 50 W

EN/LZT 146 308 R5A      November 2017  
 © Flex

**Typical Characteristics**  
**2.5 V, 15 A / 37.5 W**

**PKU 4319 PI**

**Efficiency**

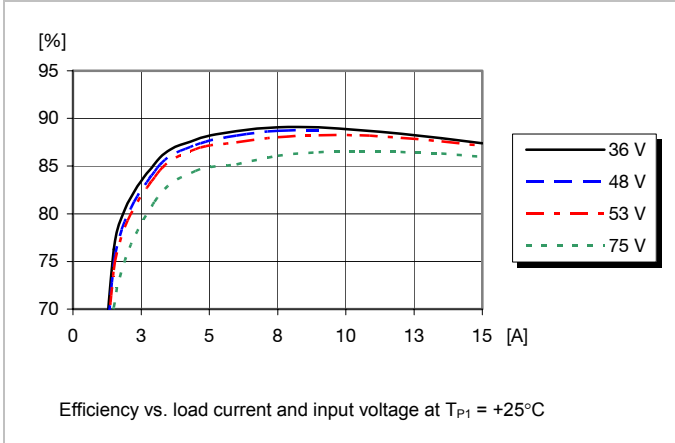

**Power Dissipation**

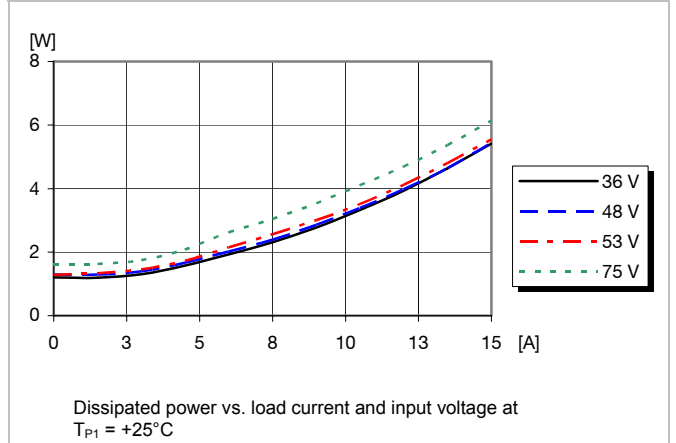

**Output Characteristics**

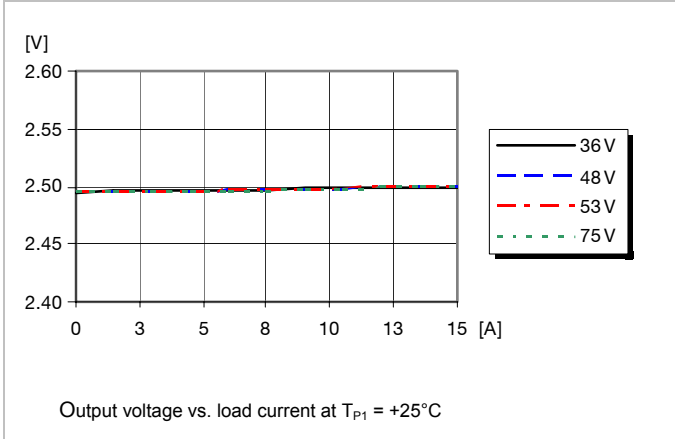

**Current Limit Characteristics**

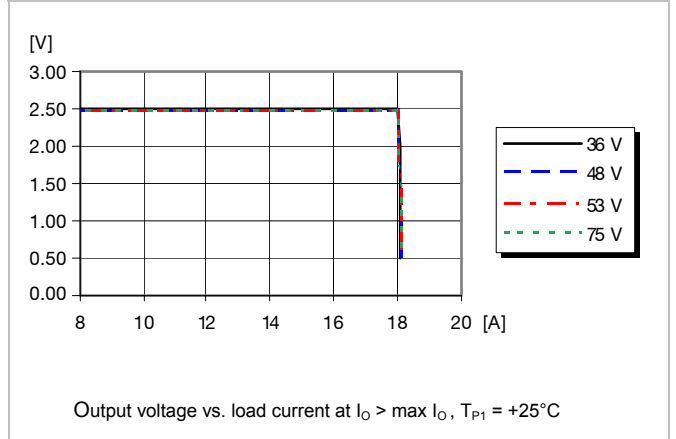

**PKU 4000 series DC/DC Converters**  
 Input 36 - 75 V, Output up to 25 A / 50 W

EN/LZT 146 308 R5A

November 2017

© Flex

### Typical Characteristics 2.5 V, 15 A / 37.5 W

**PKU 4319 PI**

#### Start-up

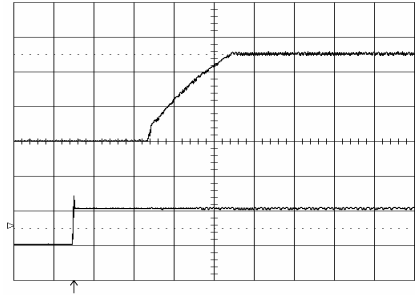

Start-up enabled by connecting  $V_1$  at:  
 $T_{P1} = +25^\circ\text{C}$ ,  $V_1 = 53\text{ V}$ ,  
 $I_O = 15\text{ A}$  resistive load.

Top trace: output voltage (1 V/div.).  
 Bottom trace: input voltage (50 V/div.).  
 Time scale: (2 ms/div.).

#### Shut-down

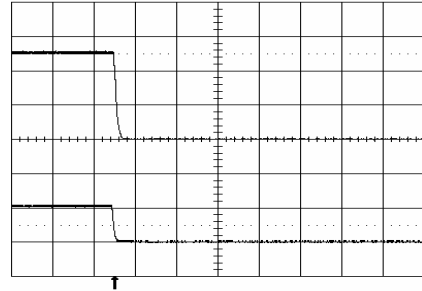

Shut-down enabled by disconnecting  $V_1$  at:  
 $T_{P1} = +25^\circ\text{C}$ ,  $V_1 = 53\text{ V}$ ,  
 $I_O = 15\text{ A}$  resistive load.

Top trace: output voltage (1 V/div.).  
 Bottom trace: input voltage (50 V/div.).  
 Time scale: (1 ms/div.).

#### Output Ripple & Noise

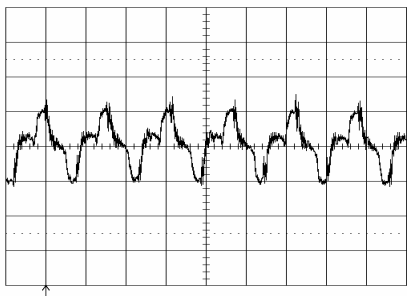

Output voltage ripple at:  
 $T_{P1} = +25^\circ\text{C}$ ,  $V_1 = 53\text{ V}$ ,  
 $I_O = 15\text{ A}$  resistive load.

Trace: output voltage (20 mV/div.).  
 Time scale: (2  $\mu\text{s}$ /div.).

#### Output Load Transient Response

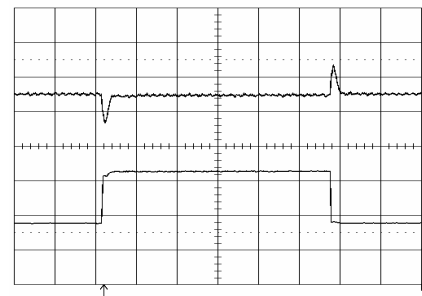

Output voltage response to load current step-change (3.75-11.25-3.75 A) at:  
 $T_{P1} = +25^\circ\text{C}$ ,  $V_1 = 53\text{ V}$ .

Top trace: output voltage (200 mV/div.).  
 Bottom trace: load current (5 A/div.).  
 Time scale: (0.1 ms/div.).

### Output Voltage Adjust (see operating information)

#### Passive adjust

The resistor value for an adjusted output voltage is calculated by using the following equations:

Output Voltage Adjust Upwards, Increase:

$$R_{adj} = \left( \frac{5.11 \times 2.50(100 + \Delta\%)}{1.225 \times \Delta\%} - \frac{511}{\Delta\%} - 10.22 \right) \text{ k}\Omega$$

Example: Increase 4% =>  $V_{out} = 2.60\text{ Vdc}$

$$\left( \frac{5.11 \times 2.50(100 + 4)}{1.225 \times 4} - \frac{511}{4} - 10.22 \right) \text{ k}\Omega = 133 \text{ k}\Omega$$

Output Voltage Adjust Downwards, Decrease:

$$R_{adj} = \left( \frac{511}{\Delta\%} \right) - 10.22 \text{ k}\Omega$$

Example: Decrease 2% =>  $V_{out} = 2.45\text{ Vdc}$

$$\left( \frac{511}{2} \right) - 10.22 \text{ k}\Omega = 245 \text{ k}\Omega$$

#### Active adjust

The output voltage may be adjusted using a voltage applied to the  $V_{adj}$  pin. This voltage is calculated by using the following equation:

$$V_{adj} = \left( 1.225 + 2.45 \times \frac{V_{desired} - 2.50}{2.50} \right) \text{ V}$$

Example: Upwards => 2.75 V

$$\left( 1.225 + 2.45 \times \frac{2.75 - 2.50}{2.50} \right) \text{ V} = 1.47 \text{ V}$$

Example: Downwards => 2.25 V

$$\left( 1.225 + 2.45 \times \frac{2.25 - 2.50}{2.50} \right) \text{ V} = 0.98 \text{ V}$$

**PKU 4000 series DC/DC Converters**  
 Input 36 - 75 V, Output up to 25 A / 50 W

EN/LZT 146 308 R5A

November 2017

© Flex

### Typical Characteristics

**PKU 4319 PI**

**2.5 V, 15 A / 37.5 W**

#### Output Current Derating – Open frame

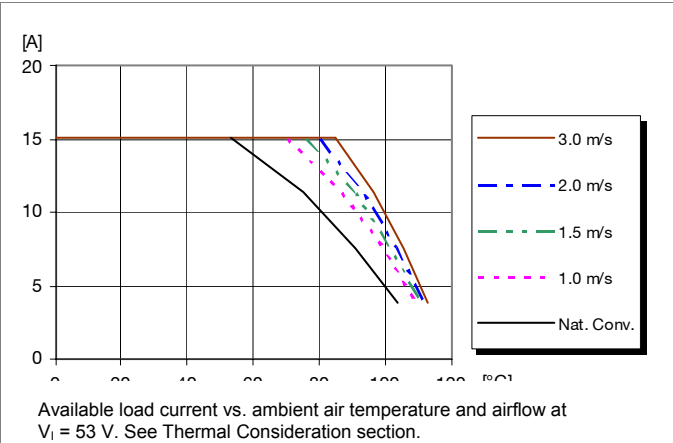

**PKU 4000 series DC/DC Converters**  
 Input 36 - 75 V, Output up to 25 A / 50 W

EN/LZT 146 308 R5A November 2017

© Flex

**Electrical Specification**  
**3.3 V, 15 A / 50 W**
**PKU 4510 PI**
 $T_{P1} = -30$  to  $+110^{\circ}\text{C}$ ,  $V_I = 36$  to  $75$  V, sense pins connected to output pins unless otherwise specified under Conditions.

 Typical values given at:  $T_{P1} = +25^{\circ}\text{C}$ ,  $V_I = 53$  V,  $I_O = \text{max}$ , unless otherwise specified under Conditions.

 Additional  $C_{in} = 1 \mu\text{F}$ . See Operating Information section for selection of capacitor types.

Characteristics		Conditions	min	typ	max	Unit
$V_I$	Input voltage range		36		75	V
$V_{loff}$	Turn-off input voltage	Decreasing input voltage See Note 1	29	31	33	V
$V_{lon}$	Turn-on input voltage	Increasing input voltage See Note 1	32	33	34.5	V
$C_I$	Internal input capacitance			0.5		$\mu\text{F}$
$P_O$	Output power		0		49.5	W
$\eta$	Efficiency	50% of max $I_O$		89.7		%
		max $I_O$		89.2		
		50% of max $I_O$ , $V_I = 48$ V		89.9		
		max $I_O$ , $V_I = 48$ V		89.3		
$P_d$	Power Dissipation	max $I_O$		6.0	9.5	W
$P_{li}$	Input idling power	$I_O = 0$ A, $V_I = 53$ V		1.8		W
$P_{RC}$	Input standby power	$V_I = 53$ V (turned off with RC)		0.15		W
$f_s$	Switching frequency	0-100 % of max $I_O$	290	320	350	kHz

$V_{Oi}$	Output voltage initial setting and accuracy	$T_{P1} = +25^{\circ}\text{C}$ , $V_I = 53$ V, $I_O = 15$ A	3.24	3.30	3.36	V
$V_O$	Output adjust range	See operating information and note 2	1.90		3.63	V
	Output voltage tolerance band	0-100% of max $I_O$	3.20		3.40	V
	Idling voltage	$I_O = 0$ A	3.24		3.36	V
	Line regulation	max $I_O$		1	10	mV
	Load regulation	$V_I = 53$ V, 0-100% of max $I_O$		8	18	mV
$V_{tr}$	Load transient voltage deviation	$V_I = 53$ V, Load step 25-75-25% of max $I_O$ , $di/dt = 1$ A/ $\mu\text{s}$		-165/+150	-330/+250	mV
$t_{tr}$	Load transient recovery time			20	40	$\mu\text{s}$
$t_r$	Ramp-up time (from 10-90% of $V_{Oi}$ )	0-100% of max $I_O$	2.5	4	4.6	ms
$t_s$	Start-up time (from $V_I$ connection to 90% of $V_{Oi}$ )		6	8	9	ms
$t_f$	$V_I$ shut-down fall time (from $V_I$ off to 10% of $V_O$ )	max $I_O$	0.1	0.2	0.3	ms
		$I_O = 1.5$ A	0.001	0.0014	0.0016	s
$t_{RC}$	RC start-up time	max $I_O$		6		ms
	RC shut-down fall time (from RC off to 10% of $V_O$ )	max $I_O$		1		ms
		$I_O = 1.5$ A		0.0015		s
$I_O$	Output current		0		15	A
$I_{lim}$	Current limit threshold	$T_{P1} < \text{max } T_{P1}$	16	18	22	A
$I_{sc}$	Short circuit current	$T_{P1} = 25^{\circ}\text{C}$ , see Note 3		14		A
$V_{Oac}$	Output ripple & noise	See ripple & noise section, $V_{Oi}$		60	100	mVp-p
OVP	Over voltage protection	$T_{P1} = +25^{\circ}\text{C}$ , $V_I = 53$ V, 0-100% of max $I_O$		4.35		V

Note 1: See Operation information section Turn-off Input Voltage.

 Note 2:  $V_I$  min 38 V to obtain 3.63 V at 49.5 W output power.

 Note 3: RMS current in hiccup mode,  $V_O$  lower than approx 0.5V.

**PKU 4000 series DC/DC Converters**  
 Input 36 - 75 V, Output up to 25 A / 50 W

EN/LZT 146 308 R5A November 2017

© Flex

### Typical Characteristics

**3.3 V, 15 A / 50 W**

**PKU 4510 PI**

#### Efficiency

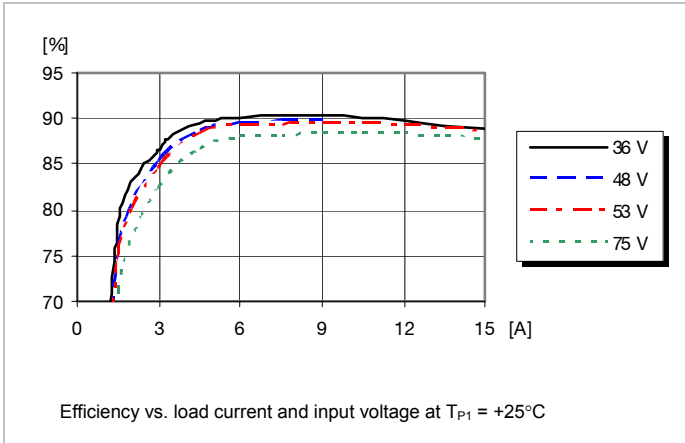

#### Power Dissipation

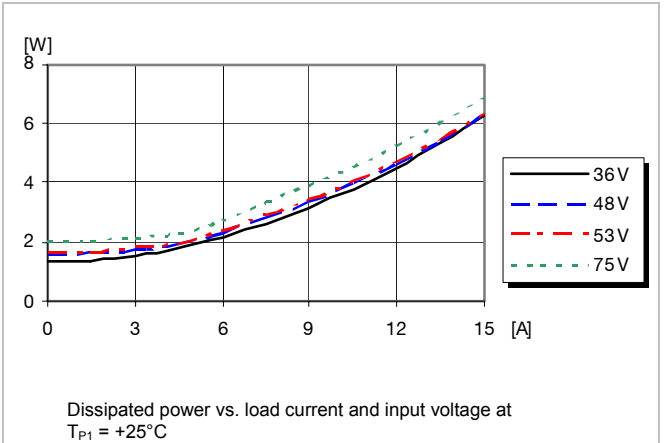

#### Output Characteristics

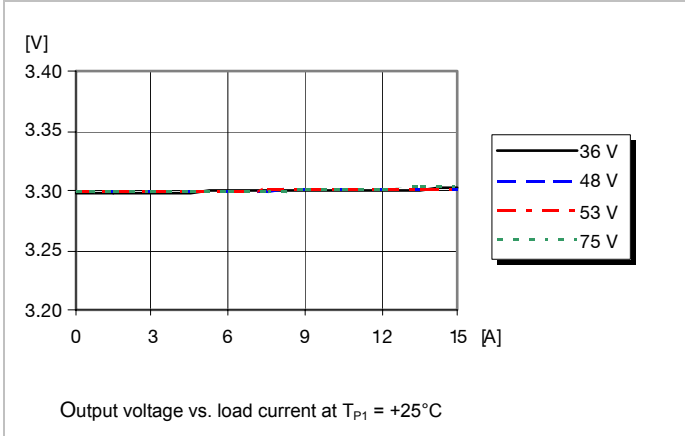

#### Current Limit Characteristics

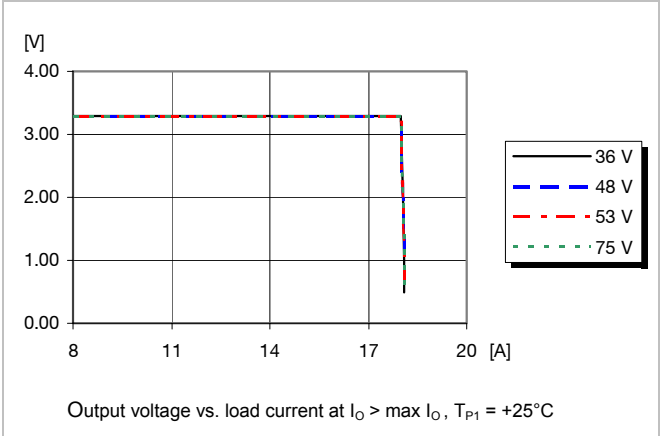

**PKU 4000 series DC/DC Converters**  
 Input 36 - 75 V, Output up to 25 A / 50 W

EN/LZT 146 308 R5A November 2017  
 © Flex

### Typical Characteristics 3.3 V, 15 A / 50 W

**PKU 4510 PI**

#### Start-up

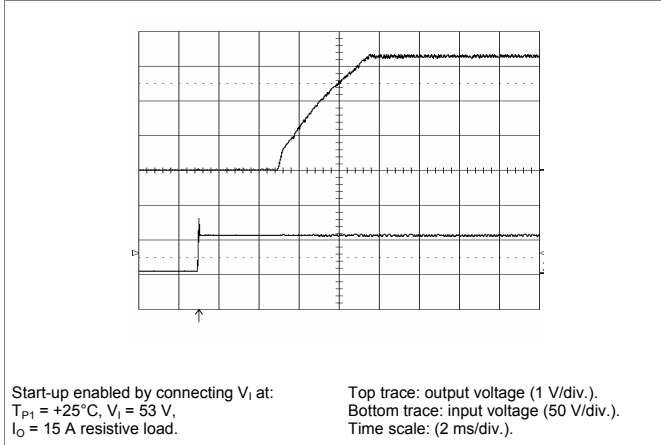

#### Shut-down

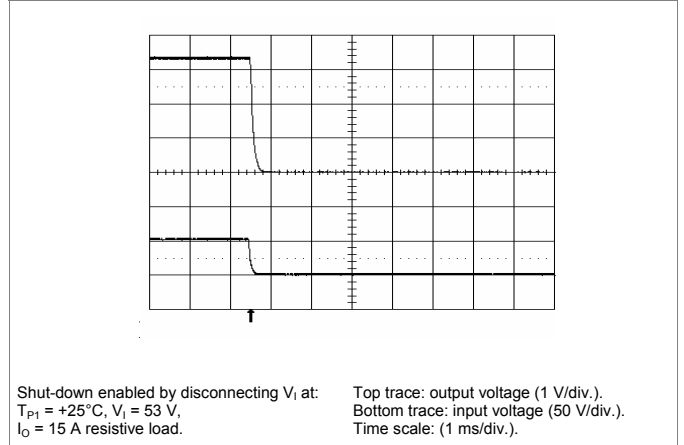

#### Output Ripple & Noise

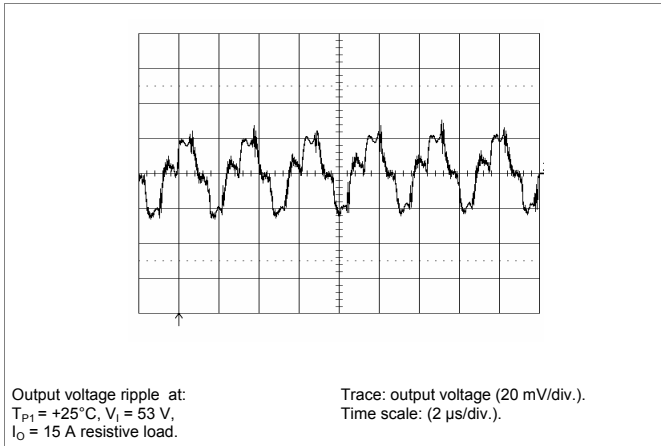

#### Output Load Transient Response

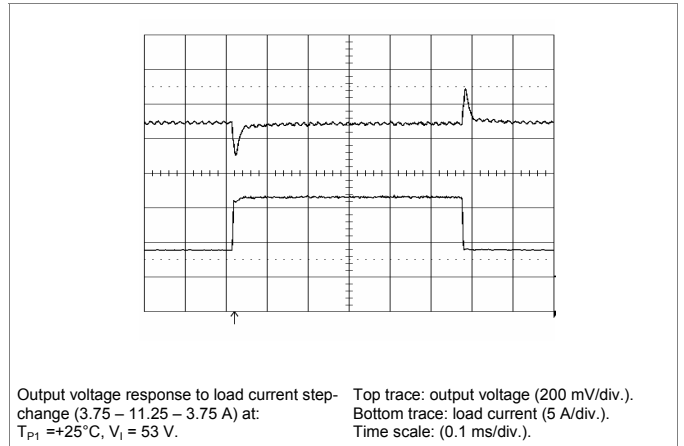

### Output Voltage Adjust (see operating information)

#### Passive adjust

The resistor value for an adjusted output voltage is calculated by using the following equations:

Output Voltage Adjust Upwards, Increase:

$$R_{adj} = \left( \frac{5.11 \times 3.30(100 + \Delta\%)}{1.225 \times \Delta\%} - \frac{511}{\Delta\%} - 10.22 \right) \text{ k}\Omega$$

Example: Increase 4% =>  $V_{out} = 3.432\text{ Vdc}$

$$\left( \frac{5.11 \times 3.30(100 + 4)}{1.225 \times 4} - \frac{511}{4} - 10.22 \right) \text{ k}\Omega = 220 \text{ k}\Omega$$

Output Voltage Adjust Downwards, Decrease:

$$R_{adj} = \left( \frac{511}{\Delta\%} \right) - 10.22 \text{ k}\Omega$$

Example: Decrease 2% =>  $V_{out} = 3.234\text{ Vdc}$

$$\left( \frac{511}{2} \right) - 10.22 \text{ k}\Omega = 245 \text{ k}\Omega$$

#### Active adjust

The output voltage may be adjusted using a voltage applied to the  $V_{adj}$  pin. This voltage is calculated by using the following equation:

$$V_{adj} = \left( 1.225 + 2.45 \times \frac{V_{desired} - 3.30}{3.30} \right) \text{ V}$$

Example: Upwards => 3.50 V

$$\left( 1.225 + 2.45 \times \frac{3.50 - 3.30}{3.30} \right) \text{ V} = 1.37 \text{ V}$$

Example: Downwards => 3.10 V

$$\left( 1.225 + 2.45 \times \frac{3.10 - 3.30}{3.30} \right) \text{ V} = 1.08 \text{ V}$$

**PKU 4000 series DC/DC Converters**  
 Input 36 - 75 V, Output up to 25 A / 50 W

EN/LZT 146 308 R5A

November 2017

© Flex

### Typical Characteristics 3.3 V, 15 A / 50 W

**PKU 4510 PI**

#### Output Current Derating – Open frame

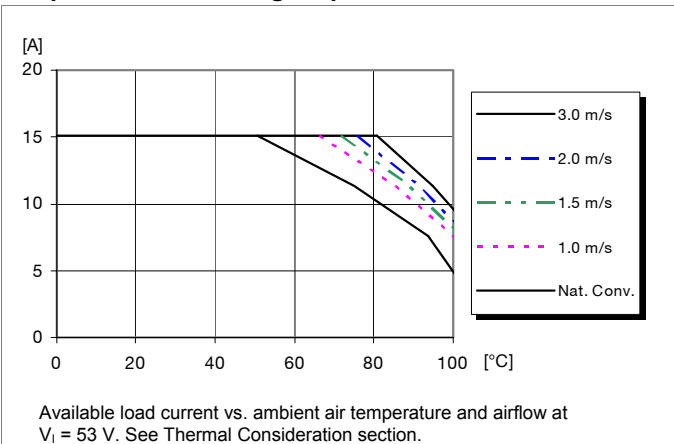



**PKU 4000 series DC/DC Converters**  
 Input 36 - 75 V, Output up to 25 A / 50 W

EN/LZT 146 308 R5A November 2017

© Flex

**Electrical Specification**  
**5.0 V, 10 A / 50 W**
**PKU 4511 PI**
 $T_{P1} = -30$  to  $+110^{\circ}\text{C}$ ,  $V_I = 36$  to  $75$  V, sense pins connected to output pins unless otherwise specified under Conditions.

 Typical values given at:  $T_{P1} = +25^{\circ}\text{C}$ ,  $V_I = 53$  V,  $I_O$  max, unless otherwise specified under Conditions.

 Additional  $C_{in} = 1 \mu\text{F}$ . See Operating Information section for selection of capacitor types.

Characteristics		Conditions	min	typ	max	Unit
$V_I$	Input voltage range		36		75	V
$V_{loff}$	Turn-off input voltage	Decreasing input voltage See Note 1	29	31	33	V
$V_{lon}$	Turn-on input voltage	Increasing input voltage See Note 1	32	33	34.5	V
$C_I$	Internal input capacitance			0.5		$\mu\text{F}$
$P_O$	Output power		0		50	W
$\eta$	Efficiency	50% of max $I_O$		89.8		%
		max $I_O$		89.6		
		50% of max $I_O$ , $V_I = 48$ V		90.0		
		max $I_O$ , $V_I = 48$ V		89.8		
$P_d$	Power Dissipation	max $I_O$		5.8	8.5	W
$P_{li}$	Input idling power	$I_O = 0$ A, $V_I = 53$ V		1.8		W
$P_{RC}$	Input standby power	$V_I = 53$ V (turned off with RC)		0.15		W
$f_s$	Switching frequency	0-100 % of max $I_O$	290	320	350	kHz

$V_{Oi}$	Output voltage initial setting and accuracy	$T_{P1} = +25^{\circ}\text{C}$ , $V_I = 53$ V, $I_O = 10$ A	4.90	5.00	5.10	V
$V_O$	Output adjust range	See operating information and note 2	4.00		5.50	V
	Output voltage tolerance band	0-100% of max $I_O$	4.85		5.15	V
	Idling voltage	$I_O = 0$ A	4.90		5.10	V
	Line regulation	max $I_O$		5	10	mV
	Load regulation	$V_I = 53$ V, 0-100% of max $I_O$		15	22	mV
$V_{tr}$	Load transient voltage deviation	$V_I = 53$ V, Load step 25-75-25% of max $I_O$ , $di/dt = 1$ A/ $\mu\text{s}$		$\pm 250$	$\pm 500$	mV
$t_{tr}$	Load transient recovery time			20	45	$\mu\text{s}$
$t_r$	Ramp-up time (from 10-90% of $V_{Oi}$ )	0-100% of max $I_O$	2	4.5	5.5	ms
$t_s$	Start-up time (from $V_I$ connection to 90% of $V_{Oi}$ )		6	8	10	ms
$t_f$	$V_I$ shut-down fall time (from $V_I$ off to 10% of $V_O$ )	max $I_O$	0.1	0.2	0.3	ms
		$I_O = 1$ A	0.001	0.0012	0.0014	s
$t_{RC}$	RC start-up time	max $I_O$		5.5		ms
	RC shut-down fall time (from RC off to 10% of $V_O$ )	max $I_O$		0.8		ms
		$I_O = 1$ A		0.0011		s
$I_O$	Output current		0		10	A
$I_{lim}$	Current limit threshold	$T_{P1} < \max T_{P1}$	10.5	13.2	15.4	A
$I_{sc}$	Short circuit current	$T_{P1} = 25^{\circ}\text{C}$ , see Note 3		8		A
$V_{Oac}$	Output ripple & noise	See ripple & noise section, $V_{Oi}$		50	100	mVp-p
OVP	Over voltage protection	$T_{P1} = +25^{\circ}\text{C}$ , $V_I = 53$ V, 0-100% of max $I_O$		6.1		V

Note 1: See Operation information section Turn-off Input Voltage.

 Note 2:  $V_I$  min 38 V to obtain 5.50 V at 50 W output power.

 Note 3: RMS current in hiccup mode,  $V_O$  lower than approx 0.5V.

**PKU 4000 series DC/DC Converters**  
 Input 36 - 75 V, Output up to 25 A / 50 W

EN/LZT 146 308 R5A      November 2017

© Flex

### Typical Characteristics 5.0 V, 10 A / 50 W

**PKU 4511 PI**

#### Efficiency

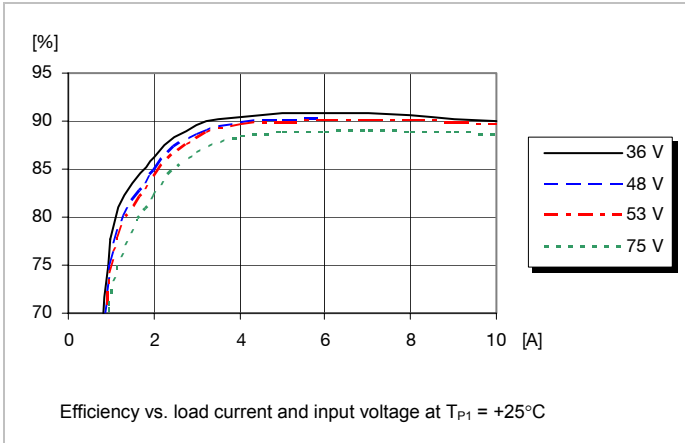

#### Power Dissipation

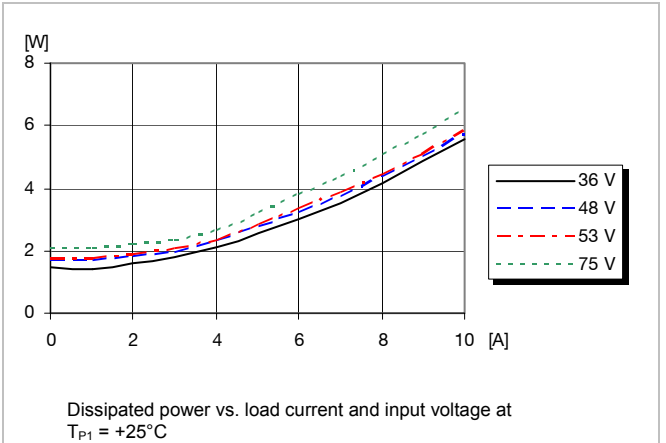

#### Output Characteristics

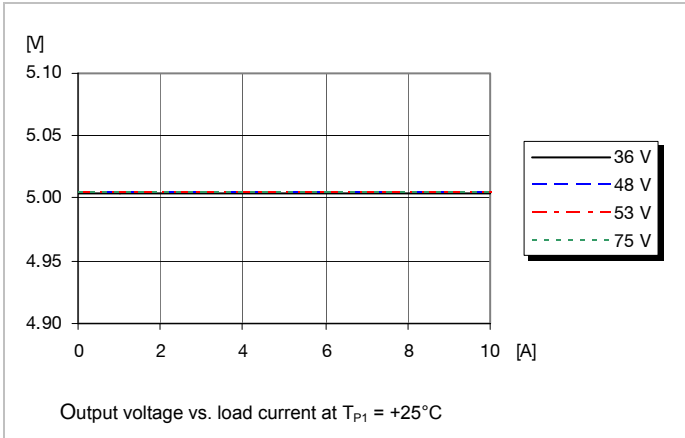

#### Current Limit Characteristics

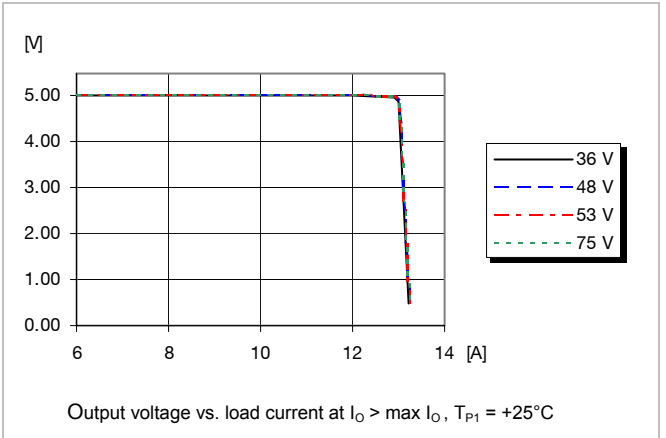

**PKU 4000 series DC/DC Converters**  
 Input 36 - 75 V, Output up to 25 A / 50 W

EN/LZT 146 308 R5A      November 2017  
 © Flex

### Typical Characteristics

**5.0 V, 10 A / 50 W**

**PKU 4511 PI**

#### Start-up

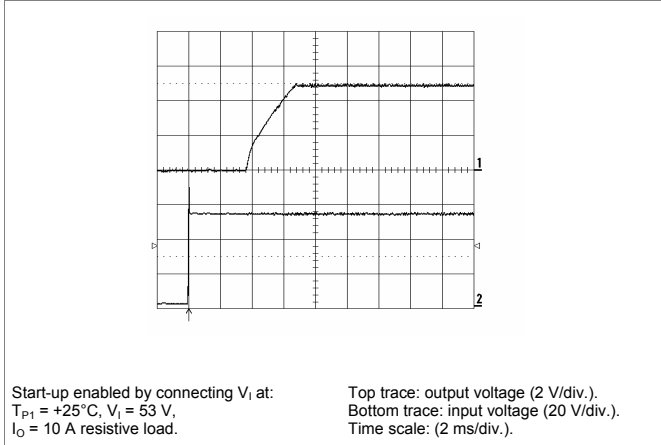

#### Shut-down

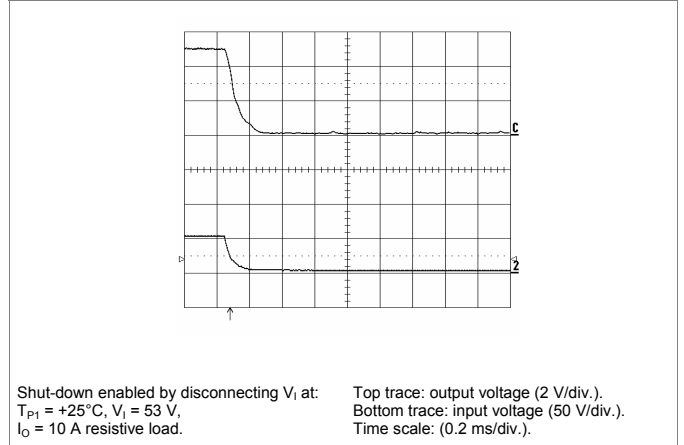

#### Output Ripple & Noise

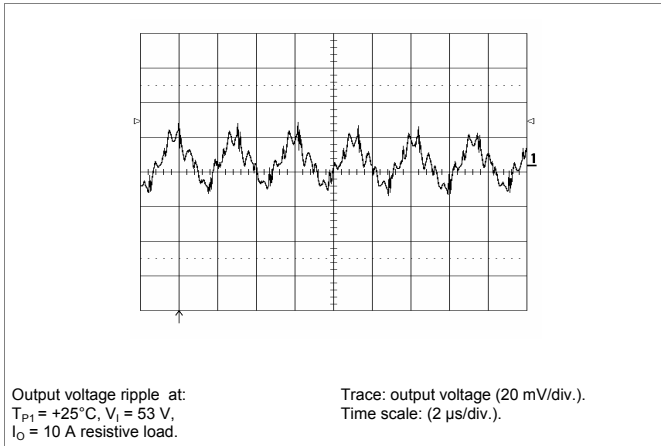

#### Output Load Transient Response

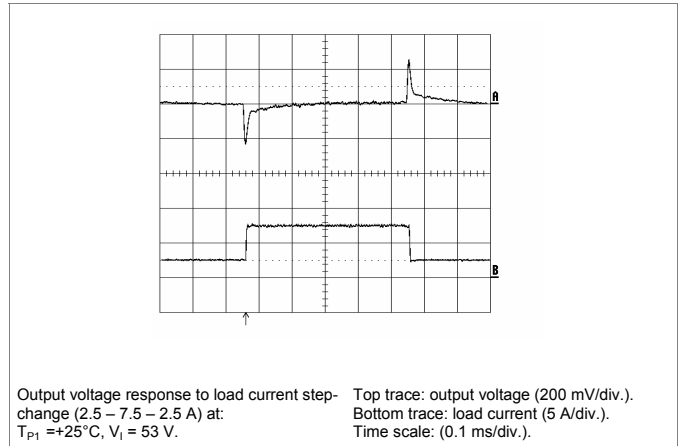

### Output Voltage Adjust (see operating information)

#### Passive adjust

The resistor value for an adjusted output voltage is calculated by using the following equations:

Output Voltage Adjust Upwards, Increase:

$$R_{adj} = \left( \frac{5.11 \times 5.0(100 + \Delta\%)}{1.225 \times \Delta\%} - \frac{511}{\Delta\%} - 10.22 \right) \text{ k}\Omega$$

Example: Increase 3% =>  $V_{out} = 5.15\text{ Vdc}$

$$\left( \frac{5.11 \times 5.0(100 + 3)}{1.225 \times 3} - \frac{511}{3} - 10.22 \right) \text{ k}\Omega = 535 \text{ k}\Omega$$

Output Voltage Adjust Downwards, Decrease:

$$R_{adj} = \left( \frac{511}{\Delta\%} \right) - 10.22 \text{ k}\Omega$$

Example: Decrease 3% =>  $V_{out} = 4.85\text{ Vdc}$

$$\left( \frac{511}{3} \right) - 10.22 \text{ k}\Omega = 160 \text{ k}\Omega$$

#### Active adjust

The output voltage may be adjusted using a voltage applied to the  $V_{adj}$  pin. This voltage is calculated by using the following equation:

$$V_{adj} = \left( 1.225 + 2.45 \times \frac{V_{desired} - 5.00}{5.00} \right) \text{ V}$$

Example: Upwards => 5.30 V

$$\left( 1.225 + 2.45 \times \frac{5.30 - 5.00}{5.00} \right) \text{ V} = 1.372 \text{ V}$$

Example: Downwards => 4.80 V

$$\left( 1.225 + 2.45 \times \frac{4.80 - 5.00}{5.00} \right) \text{ V} = 1.127 \text{ V}$$

**PKU 4000 series DC/DC Converters**  
 Input 36 - 75 V, Output up to 25 A / 50 W

EN/LZT 146 308 R5A

November 2017

© Flex

### Typical Characteristics 5.0 V, 10 A / 50 W

**PKU 4511 PI**

#### Output Current Derating – Open frame

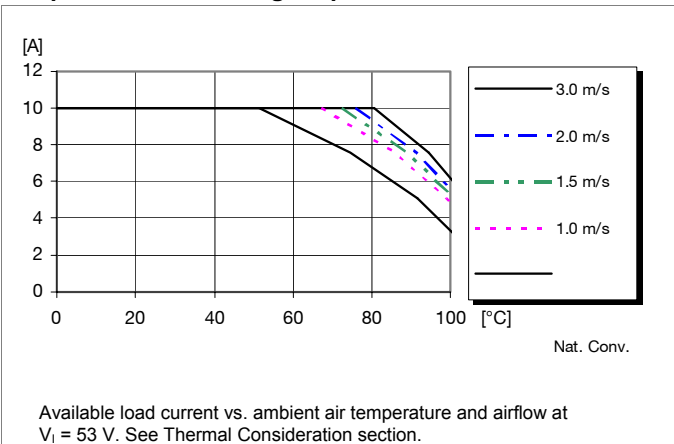

**PKU 4000 series DC/DC Converters**  
 Input 36 - 75 V, Output up to 25 A / 50 W

EN/LZT 146 308 R5A November 2017

© Flex

**Electrical Specification**  
**12 V, 4.17 A / 50 W**
**PKU 4513 PI**
 $T_{P1} = -30$  to  $+110^{\circ}\text{C}$ ,  $V_I = 36$  to  $75$  V, sense pins connected to output pins unless otherwise specified under Conditions.

 Typical values given at:  $T_{P1} = +25^{\circ}\text{C}$ ,  $V_I = 53$  V,  $I_O$  max, unless otherwise specified under Conditions.

 Additional  $C_{in} = 1 \mu\text{F}$ . See Operating Information section for selection of capacitor types.

Characteristics		Conditions	min	typ	max	Unit
$V_I$	Input voltage range		36		75	V
$V_{loff}$	Turn-off input voltage	Decreasing input voltage See Note 1	29	31	33	V
$V_{lon}$	Turn-on input voltage	Increasing input voltage See Note 1	32	33	33.5	V
$C_I$	Internal input capacitance			0.5		$\mu\text{F}$
$P_O$	Output power		0		50	W
$\eta$	Efficiency	50% of max $I_O$		88.5		%
		max $I_O$		89.0		
		50% of max $I_O$ , $V_I = 48$ V		89.5		
		max $I_O$ , $V_I = 48$ V		89.5		
$P_d$	Power Dissipation	max $I_O$		6	9.5	W
$P_{li}$	Input idling power	$I_O = 0$ A, $V_I = 53$ V		2		W
$P_{RC}$	Input standby power	$V_I = 53$ V (turned off with RC)		0.15		W
$f_s$	Switching frequency	0-100 % of max $I_O$	290	320	350	kHz

$V_{Oi}$	Output voltage initial setting and accuracy	$T_{P1} = +25^{\circ}\text{C}$ , $V_I = 53$ V, $I_O = 4.17$ A	11.76	12.00	12.24	V
$V_O$	Output adjust range	See operating information and note 2	9.60		13.20	V
	Output voltage tolerance band	0-100% of max $I_O$	11.64		12.36	V
	Idling voltage	$I_O = 0$ A	11.70		12.30	V
	Line regulation	max $I_O$		20	50	mV
	Load regulation	$V_I = 53$ V, 0-100% of max $I_O$		20	50	mV
$V_{tr}$	Load transient voltage deviation	$V_I = 53$ V, Load step 25-75-25% of max $I_O$ , $di/dt = 1$ A/ $\mu\text{s}$		$\pm 500$	$\pm 1000$	mV
$t_{tr}$	Load transient recovery time			14	50	$\mu\text{s}$
$t_r$	Ramp-up time (from 10-90% of $V_{Oi}$ )	0-100% of max $I_O$	8	11	17	ms
$t_s$	Start-up time (from $V_I$ connection to 90% of $V_{Oi}$ )		13	16	22	ms
$t_f$	$V_I$ shut-down fall time (from $V_I$ off to 10% of $V_O$ )	max $I_O$	0.1	0.2	0.3	ms
		$I_O = 0.417$ A	0.002	0.0025	0.003	s
$t_{RC}$	RC start-up time	max $I_O$		14		ms
	RC shut-down fall time (from RC off to 10% of $V_O$ )	max $I_O$		0.2		ms
		$I_O = 0.417$ A		0.0025		s
$I_O$	Output current		0		4.17	A
$I_{lim}$	Current limit threshold	$T_{P1} < \max T_{P1}$	4.4	5.3	6.5	A
$I_{sc}$	Short circuit current	$T_{P1} = 25^{\circ}\text{C}$ , see Note 3		4.2		A
$V_{Oac}$	Output ripple & noise	See ripple & noise section, $V_{Oi}$		60	120	mVp-p
OVP	Over voltage protection	$T_{P1} = +25^{\circ}\text{C}$ , $V_I = 53$ V, 0-100% of max $I_O$		15		V

Note 1: See Operation information section Turn-off Input Voltage.

 Note 2:  $V_I$  min 38V to obtain 13.2V at 50W output power.

 Note 3: RMS current in hiccup mode,  $V_O$  lower than approx 0.5V.

**PKU 4000 series DC/DC Converters**  
 Input 36 - 75 V, Output up to 25 A / 50 W

EN/LZT 146 308 R5A      November 2017

© Flex

### Typical Characteristics 12 V, 4.17 A / 50 W

**PKU 4513 PI**

#### Efficiency

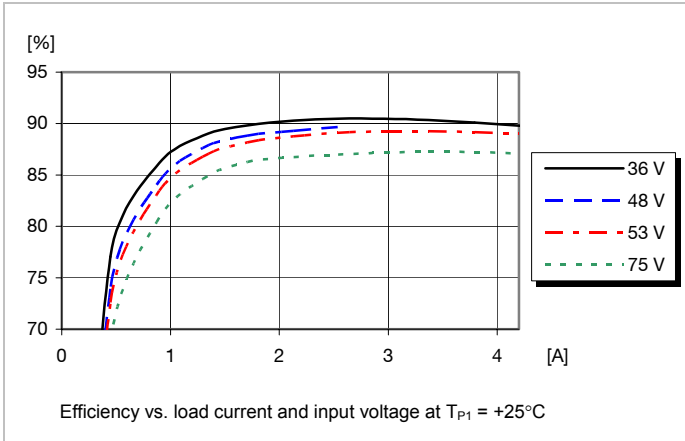

#### Power Dissipation

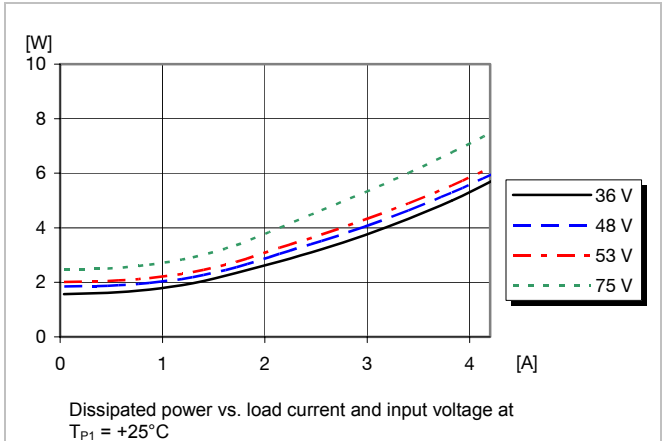

#### Output Characteristics

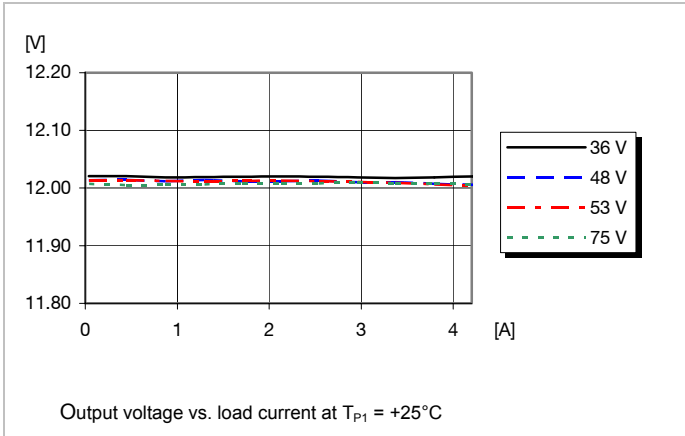

#### Current Limit Characteristics

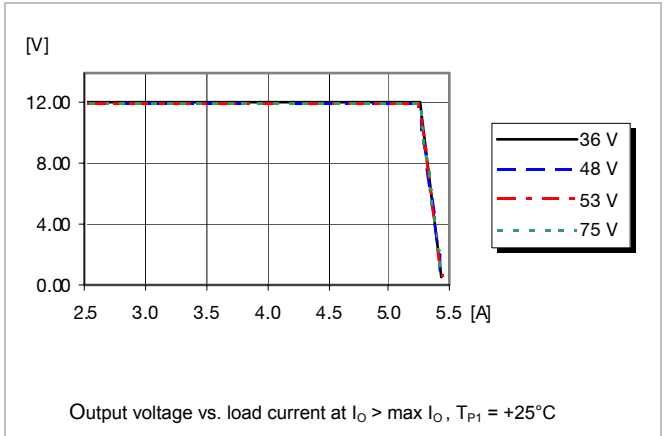

**PKU 4000 series DC/DC Converters**  
 Input 36 - 75 V, Output up to 25 A / 50 W

EN/LZT 146 308 R5A November 2017  
 © Flex

### Typical Characteristics 12 V, 4.17 A / 50 W

**PKU 4513 PI**

#### Start-up

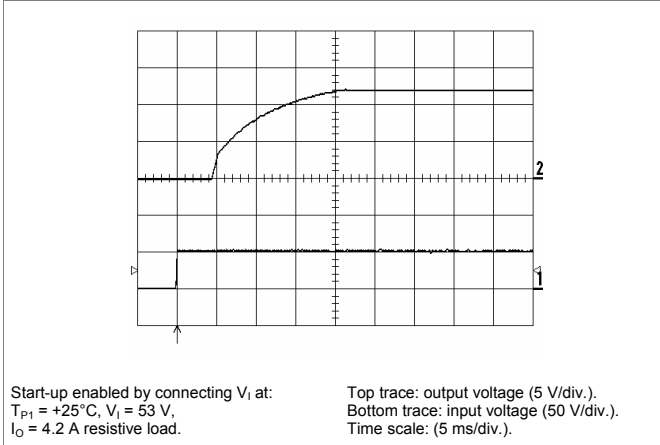

#### Shut-down

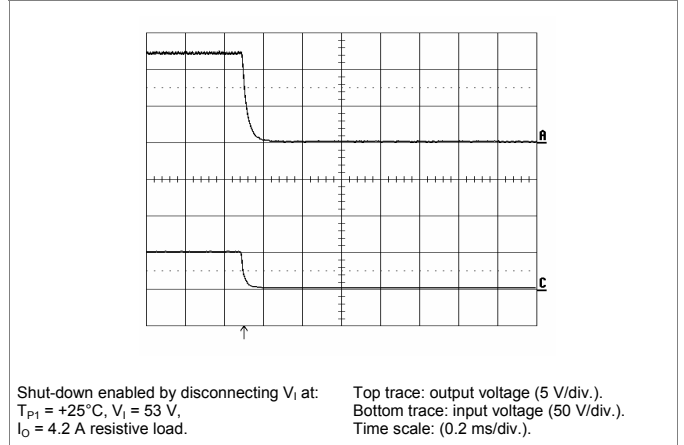

#### Output Ripple & Noise

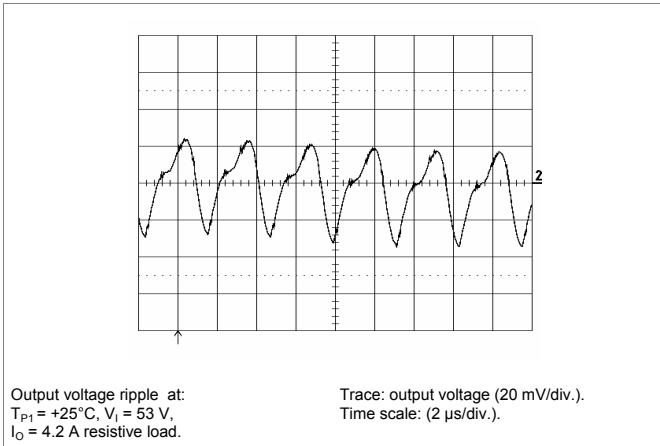

#### Output Load Transient Response

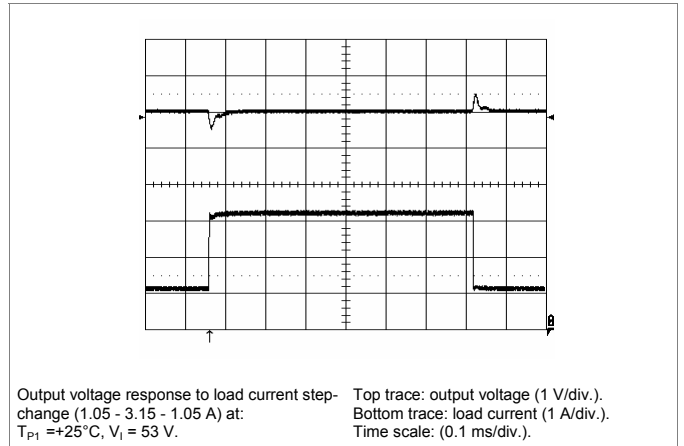

### Output Voltage Adjust (see operating information)

#### Passive adjust

The resistor value for an adjusted output voltage is calculated by using the following equations:

Output Voltage Adjust Upwards, Increase:

$$R_{adj} = \left( \frac{5.11 \times 12.0 (100 + \Delta\%)}{1.225 \times \Delta\%} - \frac{511}{\Delta\%} - 10.22 \right) \text{ k}\Omega$$

Example: Increase 4% =>  $V_{out} = 12.48\text{ V}$

$$\left( \frac{5.11 \times 12.0 (100 + 4)}{1.225 \times 4} - \frac{511}{4} - 10.22 \right) \text{ k}\Omega = 1164 \text{ k}\Omega$$

Output Voltage Adjust Downwards, Decrease:

$$R_{adj} = \left( \frac{511}{\Delta\%} \right) - 10.22 \text{ k}\Omega$$

Example: Decrease 2% =>  $V_{out} = 11.76\text{ V}$

$$\left( \frac{511}{2} \right) - 10.22 \text{ k}\Omega = 245 \text{ k}\Omega$$

#### Active adjust

The output voltage may be adjusted using a voltage applied to the  $V_{adj}$  pin. This voltage is calculated by using the following equation:

$$V_{adj} = \left( 1.225 + 2.45 \times \frac{V_{desired} - 12.0}{12.0} \right) \text{ V}$$

Example: Upwards => 12.5 V

$$\left( 1.225 + 2.45 \times \frac{12.5 - 12.0}{12.0} \right) \text{ V} = 1.33 \text{ V}$$

Example: Downwards => 11.0 V

$$\left( 1.225 + 2.45 \times \frac{11.0 - 12.0}{12.0} \right) \text{ V} = 1.02 \text{ V}$$

**PKU 4000 series DC/DC Converters**  
 Input 36 - 75 V, Output up to 25 A / 50 W

EN/LZT 146 308 R5A

November 2017

© Flex

**Typical Characteristics**  
**12 V, 4.17 A / 50 W**

**PKU 4513 PI**

**Output Current Derating – Open frame**

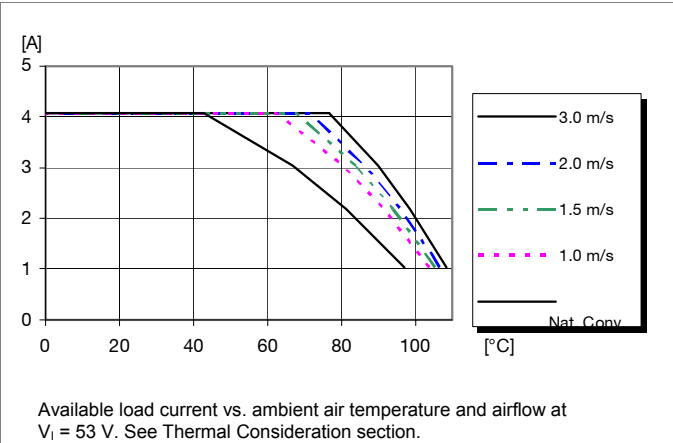



**PKU 4000 series DC/DC Converters**  
 Input 36 - 75 V, Output up to 25 A / 50 W

EN/LZT 146 308 R5A November 2017

© Flex

**Electrical Specification**  
**15 V, 3.3 A / 50 W**
**PKU 4515 PI**
 $T_{P1} = -30$  to  $+110^{\circ}\text{C}$ ,  $V_I = 36$  to  $75$  V, sense pins connected to output pins unless otherwise specified under Conditions.

 Typical values given at:  $T_{P1} = +25^{\circ}\text{C}$ ,  $V_I = 53$  V,  $I_O = \text{max}$ , unless otherwise specified under Conditions.

 Additional  $C_{in} = 1 \mu\text{F}$ . See Operating Information section for selection of capacitor types.

Characteristics		Conditions	min	typ	max	Unit
$V_I$	Input voltage range		36		75	V
$V_{loff}$	Turn-off input voltage	Decreasing input voltage See Note 1	27	28	29	V
$V_{lon}$	Turn-on input voltage	Increasing input voltage See Note 1	32	33	33.5	V
$C_I$	Internal input capacitance			0.5		$\mu\text{F}$
$P_O$	Output power		0		49.5	W
$\eta$	Efficiency	50% of max $I_O$		89.5		%
		max $I_O$		88.7		
		50% of max $I_O$ , $V_I = 48$ V		89.9		
		max $I_O$ , $V_I = 48$ V		88.8		
$P_d$	Power Dissipation	max $I_O$		6.3	9.5	W
$P_{li}$	Input idling power	$I_O = 0$ A, $V_I = 53$ V		1.8		W
$P_{RC}$	Input standby power	$V_I = 53$ V (turned off with RC)		0.14		W
$f_s$	Switching frequency	0-100 % of max $I_O$	290	320	350	kHz

$V_{Oi}$	Output voltage initial setting and accuracy	$T_{P1} = +25^{\circ}\text{C}$ , $V_I = 53$ V, $I_O = 3.3$ A	14.70	15.00	15.30	V
$V_O$	Output adjust range	See operating information	12.00		16.50	V
	Output voltage tolerance band	0-100% of max $I_O$	14.55		15.45	V
	Idling voltage	$I_O = 0$ A	14.55		15.45	V
	Line regulation	max $I_O$		60	130	mV
	Load regulation	$V_I = 53$ V, 0-100% of max $I_O$		12	50	mV
$V_{tr}$	Load transient voltage deviation	$V_I = 53$ V, Load step 25-75-25% of max $I_O$ , $di/dt = 1$ A/ $\mu\text{s}$		$\pm 400$	$\pm 800$	mV
$t_{tr}$	Load transient recovery time	See note 3		30	60	$\mu\text{s}$
$t_r$	Ramp-up time (from 10-90% of $V_{Oi}$ )	0-100% of max $I_O$	3	6	9	ms
$t_s$	Start-up time (from $V_I$ connection to 90% of $V_{Oi}$ )		8	12	16	ms
$t_f$	$V_I$ shut-down fall time (from $V_I$ off to 10% of $V_O$ )	max $I_O$	0.2	0.4	0.8	ms
		$I_O = 0.33$ A	0.0025	0.003	0.0035	s
$t_{RC}$	RC start-up time	max $I_O$		10		ms
	RC shut-down fall time (from RC off to 10% of $V_O$ )	max $I_O$		0.25		ms
		$I_O = 0.33$ A		0.0012		s
$I_O$	Output current		0		3.3	A
$I_{lim}$	Current limit threshold	$T_{P1} < \text{max } T_{P1}$	3.6	4.3	5	A
$I_{sc}$	Short circuit current	$T_{P1} = 25^{\circ}\text{C}$ , see Note 2		3.0		A
$V_{Oac}$	Output ripple & noise	See ripple & noise section, $V_{Oi}$		65	130	mVp-p
OVP	Over voltage protection	$T_{P1} = +25^{\circ}\text{C}$ , $V_I = 53$ V, 0-100% of max $I_O$		19		V

Note 1: See Operation information section Turn-off Input Voltage.

 Note 2: RMS current in hiccup mode,  $V_O$  lower than approx 0.5V.

 Note 3: Measured with 100  $\mu\text{F}$  tantalum (ESR approx 80 m $\Omega$ ) on the output.

**PKU 4000 series DC/DC Converters**  
 Input 36 - 75 V, Output up to 25 A / 50 W

EN/LZT 146 308 R5A      November 2017  
 © Flex

### Typical Characteristics 15 V, 3.3 A / 50 W

**PKU 4515 PI**

#### Efficiency

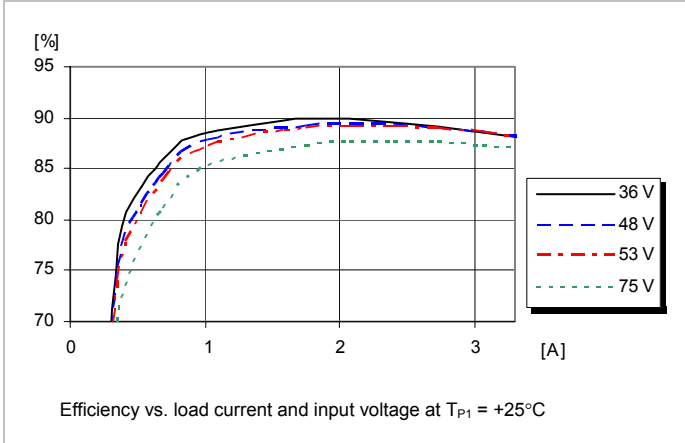

#### Power Dissipation

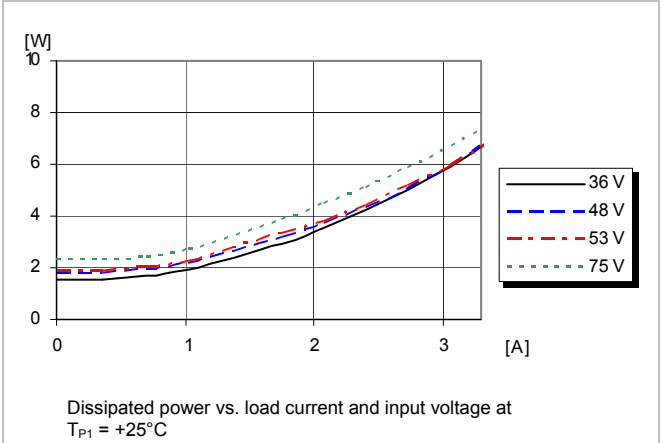

#### Output Characteristics

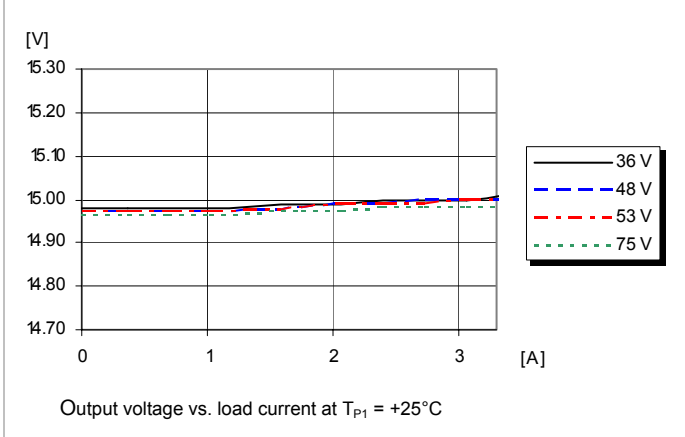

#### Current Limit Characteristics

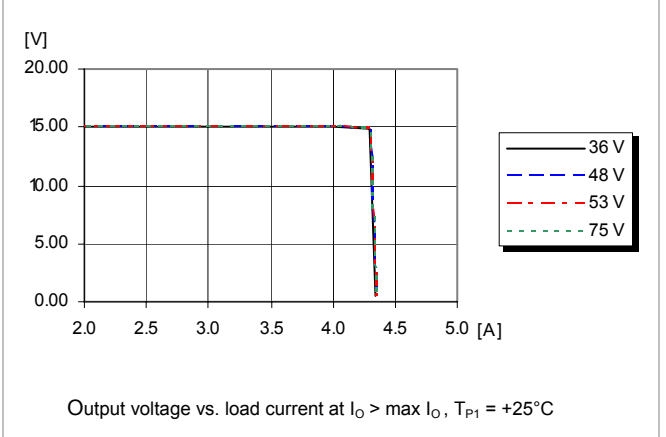

**PKU 4000 series DC/DC Converters**  
 Input 36 - 75 V, Output up to 25 A / 50 W

EN/LZT 146 308 R5A November 2017

© Flex

### Typical Characteristics 15 V, 3.3 A / 50 W

**PKU 4515 PI**

#### Start-up

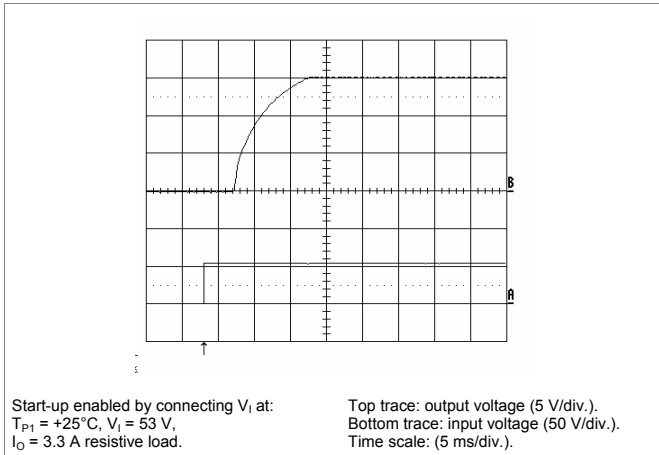

#### Shut-down

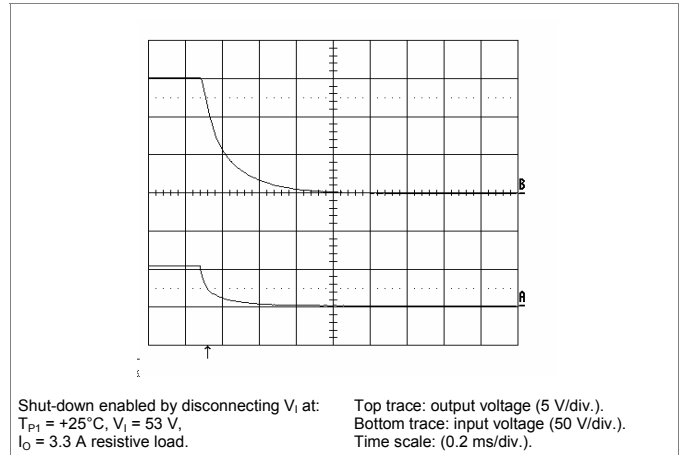

#### Output Ripple & Noise

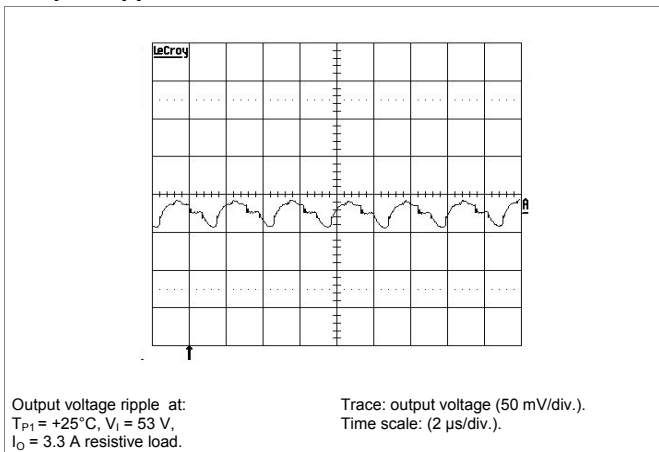

#### Output Load Transient Response

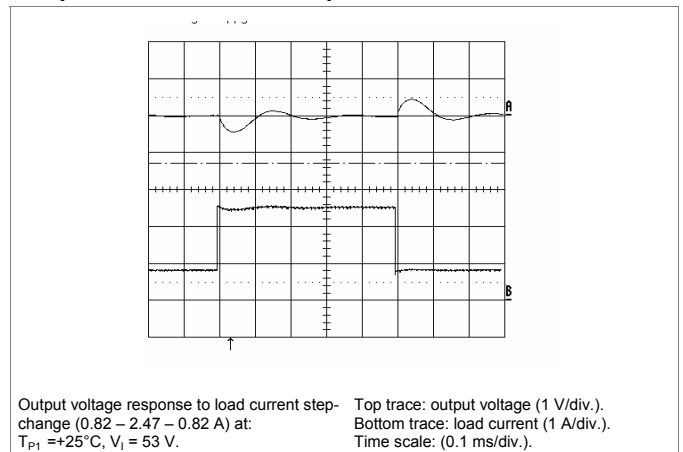

### Output Voltage Adjust (see operating information)

#### Passive adjust

The resistor value for an adjusted output voltage is calculated by using the following equations:

Output Voltage Adjust Upwards, Increase:

$$R_{adj} = \left( \frac{5.11 \times 15.0 (100 + \Delta\%)}{1.225 \times \Delta\%} - \frac{511}{\Delta\%} - 10.22 \right) \text{ k}\Omega$$

Example: Increase 4%  $\Rightarrow V_{out} = 15.60\text{ V}$

$$\left( \frac{5.11 \times 15.0 (100 + 4)}{1.225 \times 4} - \frac{511}{4} - 10.22 \right) \text{ k}\Omega = 1489 \text{ k}\Omega$$

Output Voltage Adjust Downwards, Decrease:

$$R_{adj} = \left( \frac{511}{\Delta\%} \right) - 10.22 \text{ k}\Omega$$

Example: Decrease 2%  $\Rightarrow V_{out} = 14.70\text{ V}$

$$\left( \frac{511}{2} \right) - 10.22 \text{ k}\Omega = 245 \text{ k}\Omega$$

#### Active adjust

The output voltage may be adjusted using a voltage applied to the  $V_{adj}$  pin. This voltage is calculated by using the following equation:

$$V_{adj} = \left( 1.225 + 2.45 \times \frac{V_{desired} - 15.0}{15.0} \right) \text{ V}$$

Example: Upwards  $\Rightarrow 15.60\text{ V}$

$$\left( 1.225 + 2.45 \times \frac{15.6 - 15.0}{15.0} \right) \text{ V} = 1.323 \text{ V}$$

Example: Downwards  $\Rightarrow 14.70\text{ V}$

$$\left( 1.225 + 2.45 \times \frac{14.7 - 15.0}{15.0} \right) \text{ V} = 1.176 \text{ V}$$

**PKU 4000 series DC/DC Converters**  
 Input 36 - 75 V, Output up to 25 A / 50 W

EN/LZT 146 308 R5A

November 2017

© Flex

### Typical Characteristics 15 V, 3.3 A / 50 W

**PKU 4515 PI**

#### Output Current Derating – Open frame

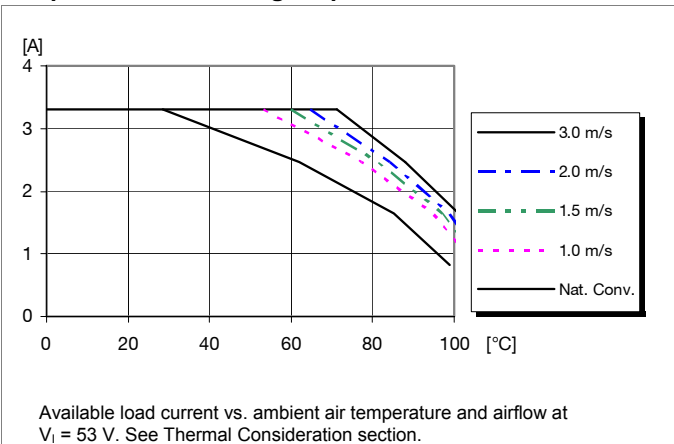

**PKU 4000 series DC/DC Converters**  
 Input 36 - 75 V, Output up to 25 A / 50 W

EN/LZT 146 308 R5A November 2017

© Flex

### EMC Specification

Conducted EMI measured according to EN55022, CISPR 22 and FCC part 15J (see test set-up). See Design Note 009 for further information. The fundamental switching frequency is 320 kHz for PKU 4511 PI @  $V_I = 53$  V, max  $I_O$ .

### Conducted EMI Input terminal value (typ)

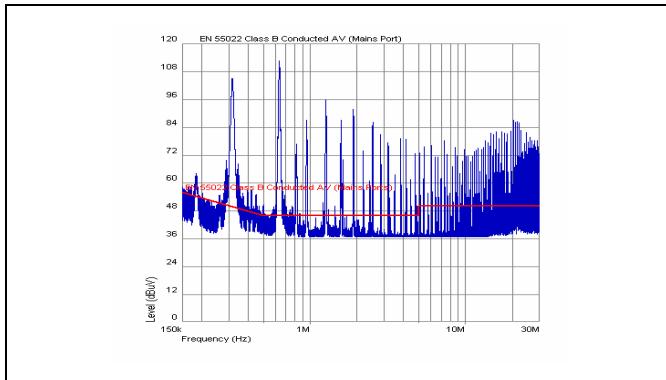

EMI without filter

### External filter (class B)

Required external input filter in order to meet class B in EN 55022, CISPR 22 and FCC part 15J.

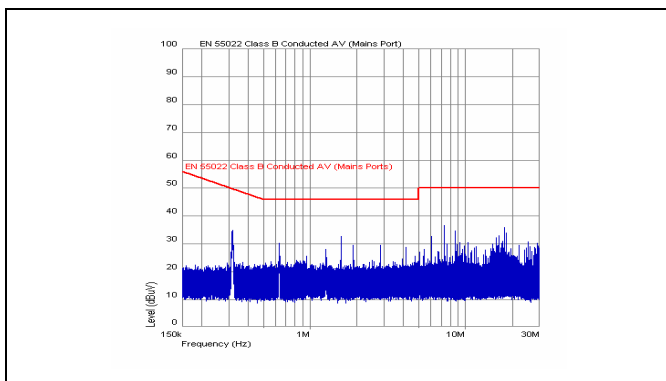
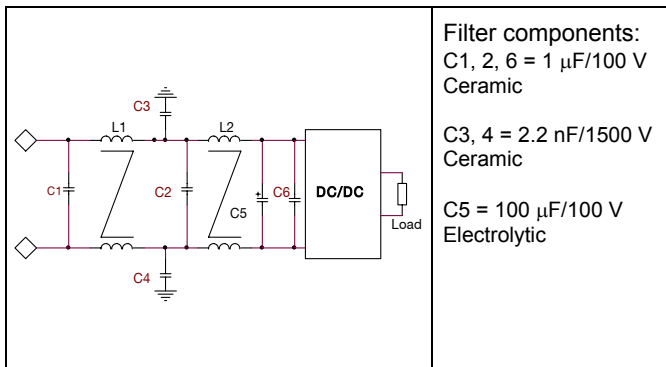

EMI with filter

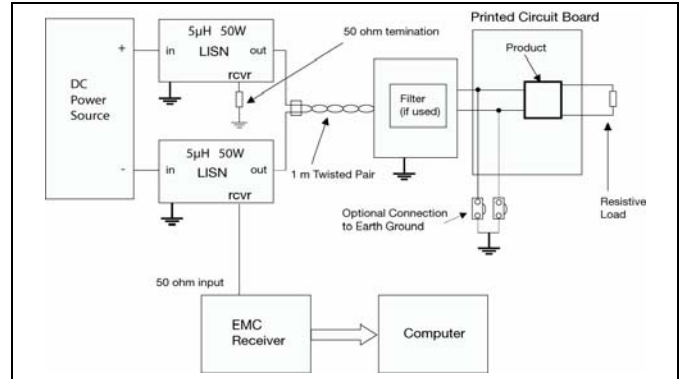

Test set-up

### Layout recommendations

The radiated EMI performance of the Product will depend on the PCB layout and ground layer design. It is also important to consider the stand-off of the product. If a ground layer is used, it should be connected to the output of the product and the equipment ground or chassis.

A ground layer will increase the stray capacitance in the PCB and improve the high frequency EMC performance.

### Output ripple and noise

Output ripple and noise measured according to figure below. See Design Note 022 for detailed information.

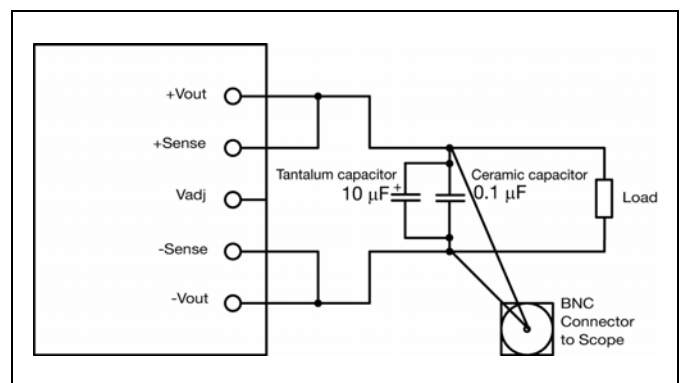

Output ripple and noise test setup

**PKU 4000 series DC/DC Converters**  
Input 36 - 75 V, Output up to 25 A / 50 W

EN/LZT 146 308 R5A November 2017

© Flex

## Operating information

### Input Voltage

The input voltage range 36 to 75Vdc meets the requirements of the European Telecom Standard ETS 300 132-2 for normal input voltage range in -48 and -60 Vdc systems, -40.5 to -57.0 V and -50.0 to -72 V respectively.

At input voltages exceeding 75 V, the power loss will be higher than at normal input voltage and  $T_{P1}$  must be limited to absolute max +120°C. The absolute maximum continuous input voltage is 80 Vdc.

### Turn-off Input Voltage

The products monitor the input voltage and will turn on and turn off at predetermined levels.

The minimum hysteresis between turn on and turn off input voltage is 1V. On the 15V version, the minimum hysteresis between turn on and turn off input voltage is 3V.

### Remote Control (RC)

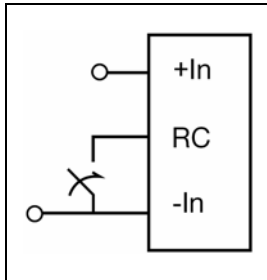

The products are fitted with a remote control function referenced to the primary negative input connection (-In), with negative and positive logic options available. The RC function allows the product to be turned on/off by an external device like a semiconductor or mechanical switch. The RC pin has an internal pull up resistor to +In.

The maximum required sink current is 0.6 mA. When the RC pin is left open, the voltage generated on the RC pin is 10 - 22 V. The standard product is provided with "negative logic" remote control and will be off until the RC pin is connected to the -In. To turn on the product the voltage between RC pin and -In should be less than 1V. To turn off the converter the RC pin should be left open, or connected to a voltage higher than 8 V referenced to -In. In situations where it is desired to have the product to power up automatically without the need for control signals or a switch, the RC pin can be wired directly to -In.

The second option is "positive logic" remote control, which can be ordered by adding the suffix "P" to the end of the part number. When the RC pin is left open, the product starts up automatically when the input voltage is applied. Turn off is achieved by connecting the RC pin to the -In. To ensure safe turn off the voltage difference between RC pin and the -In pin shall be less than 1V. The product will restart automatically when this connection is opened.

See Design Note 021 for detailed information.

### Input and Output Impedance

The impedance of both the input source and the load will interact with the impedance of the product. It is important that the input source has low characteristic impedance. The

products are designed for stable operation without external capacitors connected to the input or output. The performance in some applications can be enhanced by addition of external capacitance as described under External Decoupling Capacitors.

If the input voltage source contains significant inductance, the addition of a 22 - 100  $\mu$ F capacitor across the input of the product will ensure stable operation. The capacitor is not required when powering the product from an input source with an inductance below 10  $\mu$ H. The minimum required capacitance value depends on the output power and the input voltage. The higher output power the higher input capacitance is needed. Approximately doubled capacitance value is required for a 24 V input voltage source compared to a 48V input voltage source.

### External Decoupling Capacitors

When powering loads with significant dynamic current requirements, the voltage regulation at the point of load can be improved by addition of decoupling capacitors at the load. The most effective technique is to locate low ESR ceramic and electrolytic capacitors as close to the load as possible, using several parallel capacitors to lower the effective ESR. The ceramic capacitors will handle high-frequency dynamic load changes while the electrolytic capacitors are used to handle low frequency dynamic load changes. It is equally important to use low resistance and low inductance PCB layouts and cabling.

External decoupling capacitors will become part of the product's control loop. The control loop is optimized for a wide range of external capacitance and the maximum recommended value that could be used without any additional analysis is found in the Electrical specification.

The ESR of the capacitors is a very important parameter. Stable operation is guaranteed with a verified ESR value of >10 m $\Omega$  across the output connections.

For further information please contact your local  Power Modules representative.

### Output Voltage Adjust ( $V_{adj}$ )

The products have an Output Voltage Adjust pin ( $V_{adj}$ ). This pin can be used to adjust the output voltage above or below Output voltage initial setting.

When increasing the output voltage, the voltage at the output pins (including any remote sense compensation ) must be kept below the threshold of the over voltage protection, (OVP) to prevent the product from shutting down. At increased output voltages the maximum power rating of the product remains the same, and the max output current must be decreased correspondingly.

To increase the voltage the resistor should be connected between the  $V_{adj}$  pin and +Sense pin. The resistor value of the Output voltage adjust function is according to information given under the Output section for the respective product.

To decrease the output voltage, the resistor should be connected between the  $V_{adj}$  pin and -Sense pin.

**PKU 4000 series DC/DC Converters**  
 Input 36 - 75 V, Output up to 25 A / 50 W

EN/LZT 146 308 R5A

November 2017

© Flex

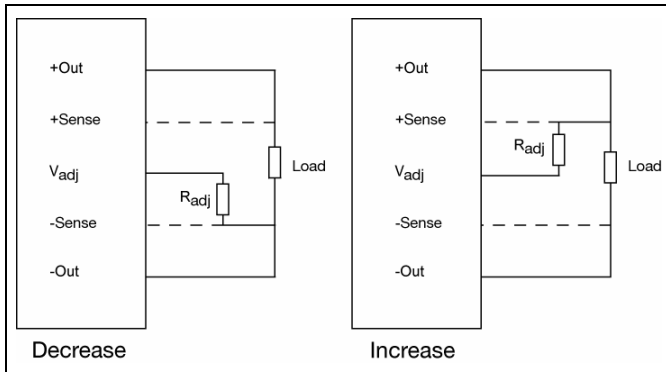
**Parallel Operation**

Two products may be paralleled for redundancy if the total power is equal or less than  $P_O$  max. It is not recommended to parallel the products without using external current sharing circuits.

See Design Note 006 for detailed information.

**Remote Sense**

The products have remote sense that can be used to compensate for voltage drops between the output and the point of load. The sense traces should be located close to the PCB ground layer to reduce noise susceptibility. The remote sense circuitry will compensate for up to 10% voltage drop between output pins and the point of load.

If the remote sense is not needed +Sense should be connected to +Out and -Sense should be connected to -Out.

**Over Temperature Protection (OTP)**

The products are protected from thermal overload by an internal over temperature shutdown circuit.

When  $T_{P1}$  as defined in thermal consideration section exceeds 135°C the product will shut down. The product will make continuous attempts to start up (non-latching mode) and resume normal operation automatically when the temperature has dropped >5°C below the temperature threshold.

**Over Voltage Protection (OVP)**

{The products have output over voltage protection that will shut down the product in over voltage conditions. The product will make continuous attempts to start up (non-latching mode) and resume normal operation automatically after removal of the over voltage condition.

**Over Current Protection (OCP)**

The converters include current limiting circuitry for protection at continuous overload.

The output voltage will decrease towards zero for output currents in excess of max output current (max  $I_O$ ). If the output voltage decreases down to 0.5-0.6 V the converter shuts down

and will make continuous attempts to start up (non-latching mode, hiccup). The converter will resume normal operation after removal of the overload. The load distribution should be designed for the maximum output short circuit current specified.

**Pre-bias Start-up**

The product has a Pre-bias start up functionality and will not sink current during start up if a pre-bias source is present at the output terminals.

Typical Pre-bias source levels for no negative current:

- Up to 0.5 V for PKU 4318L (1.2 V)
- Up to 0.7 V for PKU 4318H (1.5 V)
- Up to 1.0 V for PKU 4418G (1.8 V)
- Up to 1.5 V for PKU 4319 (2.5 V)
- Up to 2.0 V for PKU 4510 (3.3 V)
- Up to 3.0 V for PKU 4511 (5 V)
- Up to 6.0 V for PKU 4513 (12 V)
- Up to 9.0 V for PKU 4515 (15 V)

**PKU 4000 series DC/DC Converters**  
 Input 36 - 75 V, Output up to 25 A / 50 W

EN/LZT 146 308 R5A November 2017  
 © Flex

**Thermal Consideration**

**General**

The converters are designed to operate in different thermal environments and sufficient cooling must be provided to ensure reliable operation. Cooling is achieved mainly by conduction, from the pins to the host board, and convection, which is dependent on the airflow across the converter. Increased airflow enhances the cooling of the converter.

The Output Current Derating graph found in the Output section for each model provides the available output current vs. ambient air temperature and air velocity at  $V_{in} = 53 V$ .

The DC/DC converter is tested on a 254 x 254 mm, 35  $\mu m$  (1 oz), 8-layer test board mounted vertically in a wind tunnel with a cross-section of 305 x 305 mm.

Proper cooling of the DC/DC converter can be verified by measuring the temperature at positions P1. The temperature at these positions should not exceed the max values provided in the table below.

See Design Note 019 for further information.

**Definition of product operating temperature**

The product operating temperatures is used to monitor the temperature of the product, and proper thermal conditions can be verified by measuring the temperature at positions P1. The temperature at these positions  $T_{ref}$  should not exceed the maximum temperatures in the table below. The number of measurement points may vary with different thermal design and topology. Temperatures above maximum  $T_{P1}$ , measured at the reference point P1 are not allowed and may cause permanent damage.

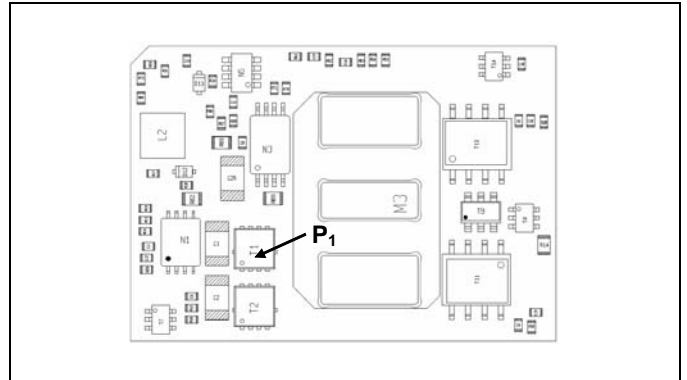

Open frame

Position	Description	Max Temp.
P <sub>1</sub>	Mosfet	T <sub>ref</sub>



**PKU 4000 series DC/DC Converters**  
 Input 36 - 75 V, Output up to 25 A / 50 W

EN/LZT 146 308 R5A      November 2017  
 © Flex

### Ambient Temperature Calculation

By using the thermal resistance the maximum allowed ambient temperature can be calculated.

- The power loss is calculated by using the formula  $((1/\eta) - 1) \times \text{output power} = \text{power losses (Pd)}$ .  
 $\eta$  = efficiency of converter. For example 89.2 % = 0.892
- Find the thermal resistance ( $R_{th}$ ) in the Thermal Resistance graph found in the Output section for each model.  
 Calculate the temperature increase ( $\Delta T$ ).  
 $\Delta T = R_{th} \times P_d$
- Max allowed ambient temperature is:  
 $\text{Max } T_{ref} - \Delta T$ .

Example PKU 4510 (@  $V_i$  53 V & 15 A) at 1 m/s:

- $(1/0.892 - 1) \times 49.5 \text{ W} = 5.99 \text{ W}$
- $5.99 \text{ W} \times 9.2^\circ\text{C/W} = 55.1^\circ\text{C}$
- $120^\circ\text{C} - 55.1^\circ\text{C} = \text{max ambient temperature is } 64.9^\circ\text{C}$

The actual temperature will be dependent on several factors such as the PCB size, number of layers and direction of airflow.

### Connections

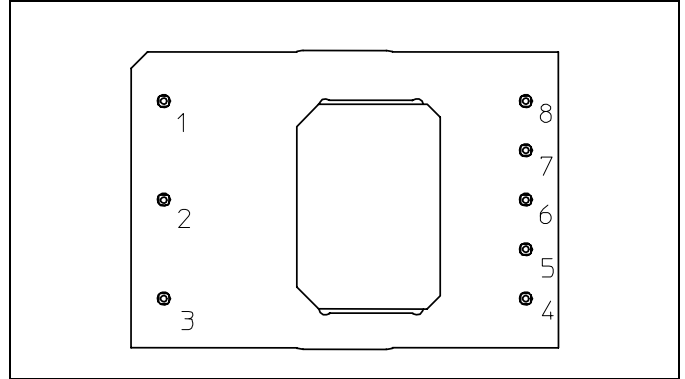

Pin	Designation	Function
1	+In	Positive Input
2	RC	Remote Control
3	-In	Negative Input
4	-Out	Negative Output
5	-Sen	Negative Sense
6	$V_{adj}$	Output Voltage Adjust
7	+Sen	Positive Sense
8	+Out	Positive Output

**PKU 4000 series DC/DC Converters**  
 Input 36 - 75 V, Output up to 25 A / 50 W

EN/LZT 146 308 R5A November 2017

© Flex

**Mechanical Information - Hole Mount Version**

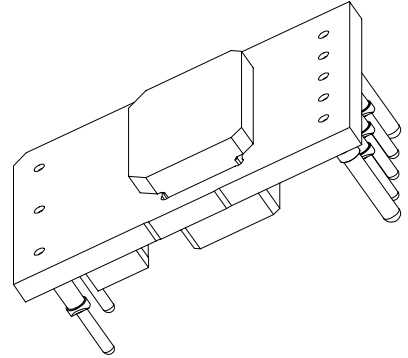
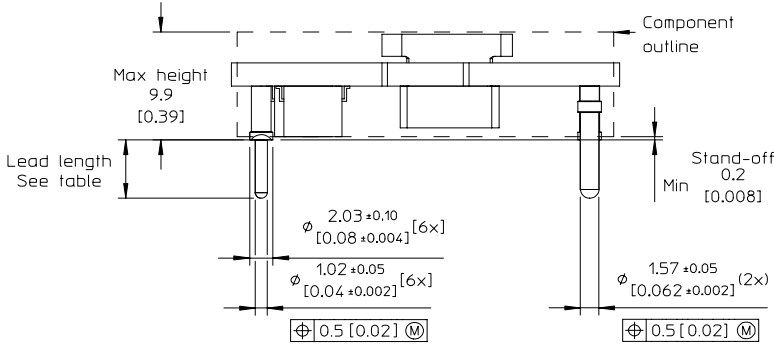

TOP VIEW  
 Pin positions according to the recommended footprint

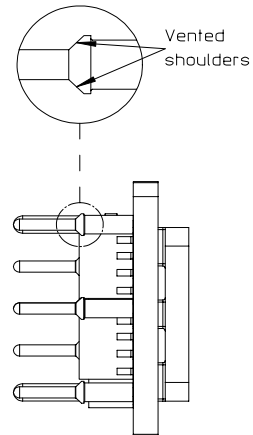
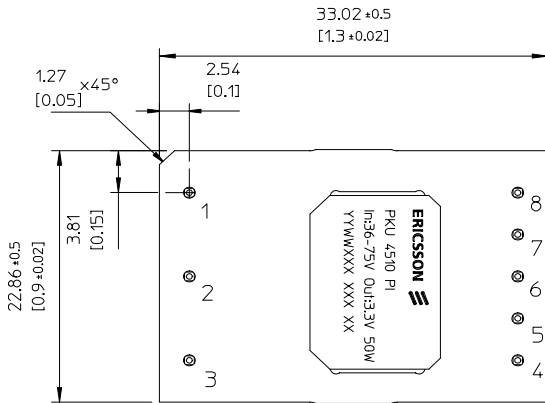

RECOMMENDED FOOTPRINT - TOP VIEW

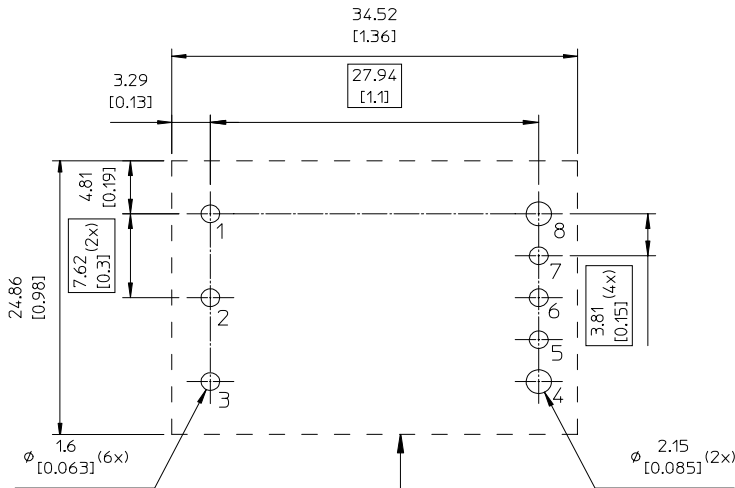

Pin option	Lead Length
Standard	5.30 [0.209]
LA	3.69 [0.145] (cut)
LB	4.57 [0.18] (cut)

Recommended keep away area for user components. The stand-off, in combination with insulating material, ensures that requirements as per IEC/EN/UL60950 are met and 1500 V isolation maintained even if open vias or traces are present under the dc/dc-converter.

Pins:  
 Material: Copper alloy  
 Plating: 0.1 μm Gold over 2 μm Nickel

Weight: Typical 13 g

All dimensions in mm [inch].  
 Tolerances unless specified

X.x mm ±0.5 mm [±0.02],

X.xx mm ±0.25 mm [±0.01]

(not applied on footprint or typical values)

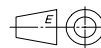

**PKU 4000 series DC/DC Converters**  
 Input 36 - 75 V, Output up to 25 A / 50 W

EN/LZT 146 308 R5A November 2017

© Flex

**Mechanical Information - Surface Mount Version**

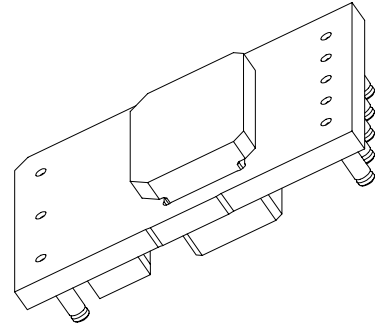
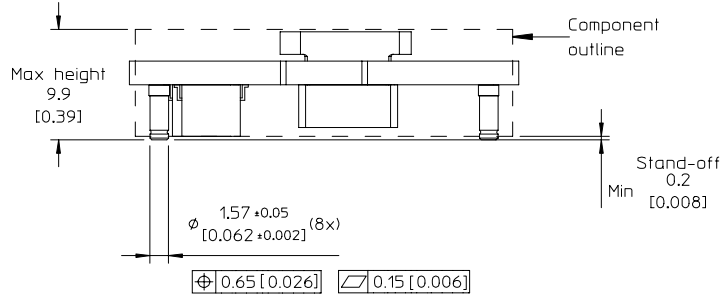

TOP VIEW  
 Pin positions according to the recommended footprint

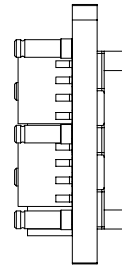
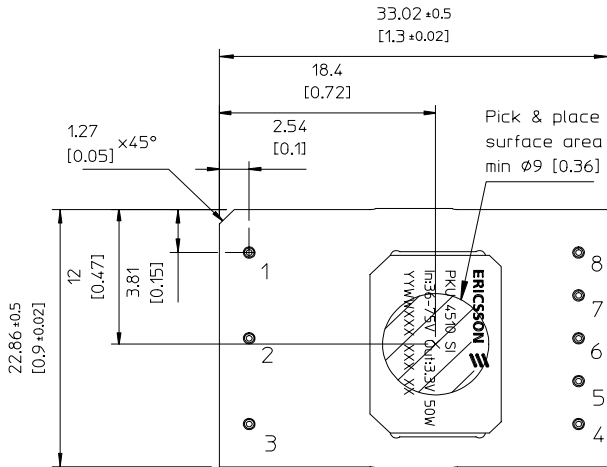

RECOMMENDED FOOTPRINT - TOP VIEW

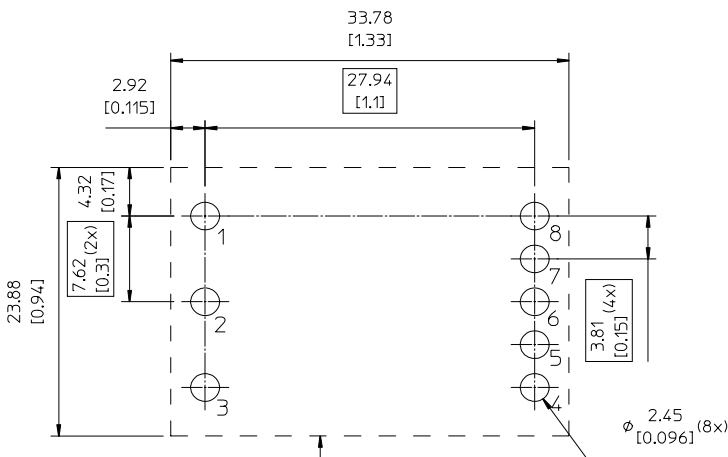

Recommended keep away area for user components. The stand-off, in combination with insulating material, ensures that requirements as per IEC/EN/UL60950 are met and 1500 V isolation maintained even if open vias or traces are present under the dc/dc-converter.

Layout considerations:

Use sufficient numbers of vias connected to output pin pads for good thermal and current conductivity.

Pins:

Material: Copper alloy  
 Plating: 0.1 µm Gold over 2 µm Nickel

Weight: Typical 13 g

All dimensions are in mm [inch]

Tolerances unless specified

X.x mm ±0.5 mm [±0.02]

X.xx mm ±0.25 mm [±0.01]

(not applied on footprint or typical values)

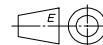

**PKU 4000 series DC/DC Converters**  
 Input 36 - 75 V, Output up to 25 A / 50 W

EN/LZT 146 308 R5A November 2017

© Flex

**Soldering Information - Surface Mounting**

The surface mount product is intended for forced convection or vapor phase reflow soldering in SnPb or Pb-free processes.

The reflow profile should be optimised to avoid excessive heating of the product. It is recommended to have a sufficiently extended preheat time to ensure an even temperature across the host PCB and it is also recommended to minimize the time in reflow.

A no-clean flux is recommended to avoid entrapment of cleaning fluids in cavities inside the product or between the product and the host board, since cleaning residues may affect long time reliability and isolation voltage.

General reflow process specifications		SnPb eutectic	Pb-free
Average ramp-up ( $T_{PRODUCT}$ )		3°C/s max	3°C/s max
Typical solder melting (liquidus) temperature	$T_L$	183°C	221°C
Minimum reflow time above $T_L$		30 s	30 s
Minimum pin temperature	$T_{PIN}$	210°C	235°C
Peak product temperature	$T_{PRODUCT}$	225°C	260°C
Average ramp-down ( $T_{PRODUCT}$ )		6°C/s max	6°C/s max
Maximum time 25°C to peak		6 minutes	8 minutes

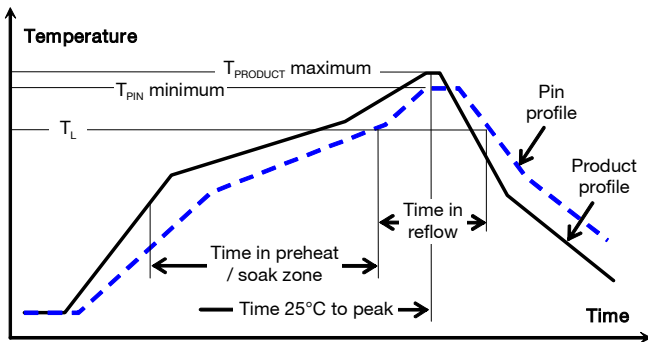

**Minimum Pin Temperature Recommendations**

Pin number 8 is chosen as reference location for the minimum pin temperature recommendation since this will likely be the coolest solder joint during the reflow process.

**SnPb solder processes**

For SnPb solder processes, a pin temperature ( $T_{PIN}$ ) in excess of the solder melting temperature, ( $T_L$ , 183°C for Sn63Pb37) for more than 30 seconds and a peak temperature of 210°C is recommended to ensure a reliable solder joint.

For dry packed products only: depending on the type of solder paste and flux system used on the host board, up to a recommended maximum temperature of 245°C could be used, if the products are kept in a controlled environment (dry pack handling and storage) prior to assembly.

**Lead-free (Pb-free) solder processes**

For Pb-free solder processes, a pin temperature ( $T_{PIN}$ ) in excess of the solder melting temperature ( $T_L$ , 217 to 221°C for SnAgCu solder alloys) for more than 30 seconds and a peak temperature of 235°C on all solder joints is recommended to ensure a reliable solder joint.

**Maximum Product Temperature Requirements**

Top of the product PCB near pin 2 is chosen as reference location for the maximum (peak) allowed product temperature ( $T_{PRODUCT}$ ) since this will likely be the warmest part of the product during the reflow process.

**SnPb solder processes**

For SnPb solder processes, the product is qualified for MSL 1 according to IPC/JEDEC standard J-STD-020C.

During reflow  $T_{PRODUCT}$  must not exceed 225 °C at any time.

**Pb-free solder processes**

For Pb-free solder processes, the product is qualified for MSL 3 according to IPC/JEDEC standard J-STD-020C.

During reflow  $T_{PRODUCT}$  must not exceed 260 °C at any time.

**Dry Pack Information**

Products intended for Pb-free reflow soldering processes are delivered in standard moisture barrier bags according to IPC/JEDEC standard J-STD-033 (Handling, packing, shipping and use of moisture/reflow sensitivity surface mount devices).

Using products in high temperature Pb-free soldering processes requires dry pack storage and handling. In case the products have been stored in an uncontrolled environment and no longer can be considered dry, the modules must be baked according to J-STD-033.

**Thermocoupler Attachment**

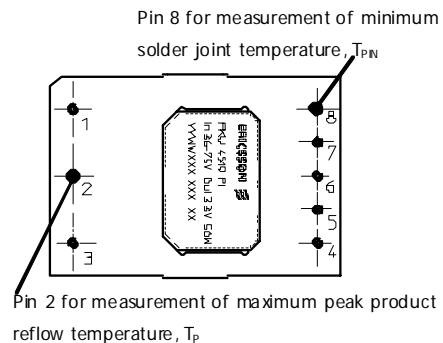

**PKU 4000 series DC/DC Converters**  
 Input 36 - 75 V, Output up to 25 A / 50 W

EN/LZT 146 308 R5A November 2017

© Flex

### Soldering Information - Hole Mounting

The hole mounted product is intended for plated through hole mounting by wave or manual soldering. The pin temperature is specified to maximum to 270°C for maximum 10 seconds.

A maximum preheat rate of 4°C/s and maximum preheat temperature of 150°C is suggested. When soldering by hand, care should be taken to avoid direct contact between the hot soldering iron tip and the pins for more than a few seconds in order to prevent overheating.

A no-clean flux is recommended to avoid entrapment of cleaning fluids in cavities inside the product or between the product and the host board. The cleaning residues may affect long time reliability and isolation voltage.

### Delivery Package Information

The hole mount products are delivered in antistatic injection molded trays (Jedec design guide 4.10D standard). The surface mount products are delivered in antistatic injection molded trays (Jedec design guide 4.10D standard) and in antistatic carrier tape (EIA 481 standard).

Tray Specifications	
<b>Material</b>	Antistatic PPE
<b>Surface resistance</b>	$10^5 < \text{Ohm/square} < 10^{12}$
<b>Bakeability</b>	The trays can be baked at maximum 125°C for 48 hours
<b>Tray thickness</b>	20 mm [0.787 inch]
<b>Box capacity</b>	150 products (5 full trays/box)
<b>Tray weight</b>	520 g empty, 130 g full tray

Carrier Tape Specifications	
<b>Material</b>	Antistatic PS
<b>Surface resistance</b>	$< 10^7 \text{ Ohm/square}$
<b>Bakeability</b>	The tape is not bakeable
<b>Tape width, W</b>	56 mm [2.2 inch]
<b>Pocket pitch, P<sub>1</sub></b>	36 mm [1.42 inch]
<b>Pocket depth, K<sub>0</sub></b>	11.4 mm [0.449 inch]
<b>Reel diameter</b>	380 mm [15 inch]
<b>Reel capacity</b>	200 products /reel
<b>Reel weight</b>	3 kg/full reel

EIA standard carrier tape

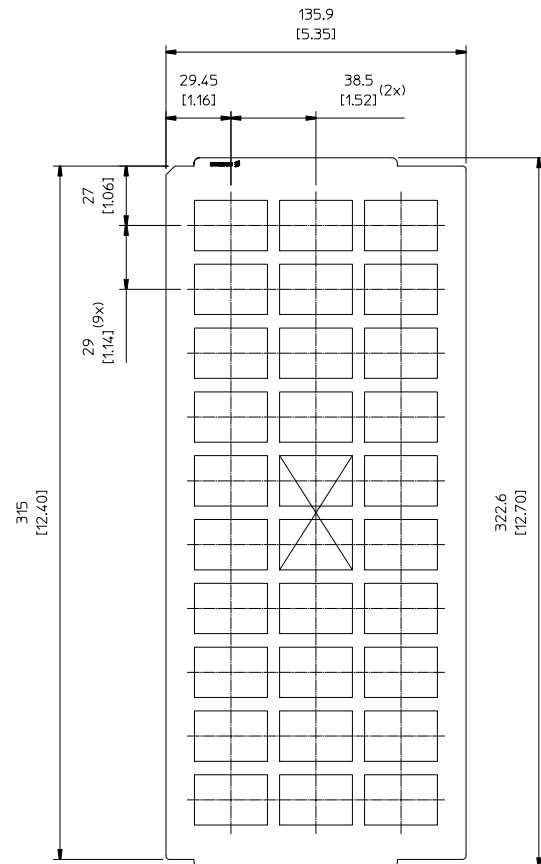
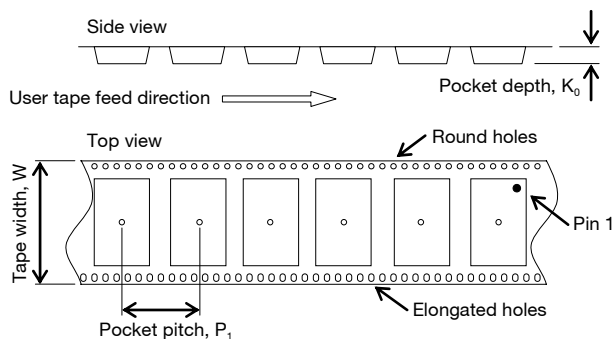

X = Vacuum pickup area.  
 All dimensions in mm [inch]  
 Tolerances: X.x mm ±0.26 [0.01]. X.xx mm ±0.13 [0.05]

**PKU 4000 series DC/DC Converters**  
 Input 36 - 75 V, Output up to 25 A / 50 W

EN/LZT 146 308 R5A November 2017

© Flex

**Product Qualification Specification**

Characteristics			
External visual inspection	IPC-A-610		
Change of temperature (Temperature cycling)	IEC 60068-2-14 Na	Temperature range Number of cycles Dwell/transfer time	-40 to 100°C 1000 15 min/0-1 min
Cold (in operation)	IEC 60068-2-1 Ad	Temperature T <sub>A</sub> Duration	-45°C 72 h
Damp heat	IEC 60068-2-67 Cy	Temperature Humidity Duration	85°C 85 % RH 1000 hours
Dry heat	IEC 60068-2-2 Bd	Temperature Duration	125°C 1000 h
Electrostatic discharge susceptibility	IEC 61340-3-1, JESD 22-A114 IEC 61340-3-2, JESD 22-A115	Human body model (HBM) Machine Model (MM)	Class 2, 2000 V Class 3, 200 V
Immersion in cleaning solvents	IEC 60068-2-45 XA, method 2	Water Glycol ether Isopropyl alcohol	55°C 35°C 35°C
Mechanical shock	IEC 60068-2-27 Ea	Peak acceleration Duration	100 g 6 ms
Moisture reflow sensitivity <sup>1</sup>	J-STD-020C	Level 1 (SnPb-eutectic) Level 3 (Pb Free)	225°C 260°C
Operational life test	MIL-STD-202G, method 108A	Duration	1000 h
Resistance to soldering heat <sup>2</sup>	IEC 60068-2-20 Tb, method 1A	Solder temperature Duration	270°C 10-13 s
Robustness of terminations	IEC 60068-2-21 Test Ua1 IEC 60068-2-21 Test Ue1	Through hole mount products Surface mount products	All leads All leads
Solderability	IEC 60068-2-58 test Td <sup>1</sup>	Preconditioning Temperature, SnPb Eutectic Temperature, Pb-free	150°C dry bake 16 h 215°C 235°C
	IEC 60068-2-20 test Ta <sup>2</sup>	Preconditioning Temperature, SnPb Eutectic Temperature, Pb-free	Steam ageing 235°C 245°C
Vibration, broad band random	IEC 60068-2-64 Fh, method 1	Frequency Spectral density Duration	10 to 500 Hz 0.07 g <sup>2</sup> /Hz 10 min in each direction

**Notes**
<sup>1</sup> Only for products intended for reflow soldering (surface mount products)

<sup>2</sup> Only for products intended for wave soldering (plated through hole products)

Компания «Океан Электроники» предлагает заключение долгосрочных отношений при поставках импортных электронных компонентов на взаимовыгодных условиях!

Наши преимущества:

- Поставка оригинальных импортных электронных компонентов напрямую с производств Америки, Европы и Азии, а так же с крупнейших складов мира;
- Широкая линейка поставок активных и пассивных импортных электронных компонентов (более 30 млн. наименований);
- Поставка сложных, дефицитных, либо снятых с производства позиций;
- Оперативные сроки поставки под заказ (от 5 рабочих дней);
- Экспресс доставка в любую точку России;
- Помощь Конструкторского Отдела и консультации квалифицированных инженеров;
- Техническая поддержка проекта, помощь в подборе аналогов, поставка прототипов;
- Поставка электронных компонентов под контролем ВП;
- Система менеджмента качества сертифицирована по Международному стандарту ISO 9001;
- При необходимости вся продукция военного и аэрокосмического назначения проходит испытания и сертификацию в лаборатории (по согласованию с заказчиком);
- Поставка специализированных компонентов военного и аэрокосмического уровня качества (Xilinx, Altera, Analog Devices, Intersil, Interpoint, Microsemi, Actel, Aeroflex, Peregrine, VPT, Syfer, Eurofarad, Texas Instruments, MS Kennedy, Miteq, Cobham, E2V, MA-COM, Hittite, Mini-Circuits, General Dynamics и др.);

Компания «Океан Электроники» является официальным дистрибьютором и эксклюзивным представителем в России одного из крупнейших производителей разъемов военного и аэрокосмического назначения «JONHON», а так же официальным дистрибьютором и эксклюзивным представителем в России производителя высокотехнологичных и надежных решений для передачи СВЧ сигналов «FORSTAR».



## JONHON

«JONHON» (основан в 1970 г.)

Разъемы специального, военного и аэрокосмического назначения:

(Применяются в военной, авиационной, аэрокосмической, морской, железнодорожной, горно- и нефтедобывающей отраслях промышленности)

«FORSTAR» (основан в 1998 г.)

ВЧ соединители, коаксиальные кабели, кабельные сборки и микроволновые компоненты:

(Применяются в телекоммуникациях гражданского и специального назначения, в средствах связи, РЛС, а так же военной, авиационной и аэрокосмической отраслях промышленности).



Телефон: 8 (812) 309-75-97 (многоканальный)

Факс: 8 (812) 320-03-32

Электронная почта: [ocean@oceanchips.ru](mailto:ocean@oceanchips.ru)

Web: <http://oceanchips.ru/>

Адрес: 198099, г. Санкт-Петербург, ул. Калинина, д. 2, корп. 4, лит. А