

High Precision Surface Mount Current Sensing Chip Resistor with Power Rating to 1 W, Temperature Coefficient of Resistance of ± 2 ppm/ $^{\circ}$ C and Load Life Stability of $\pm 0.015\%$



INTRODUCTION

Model VCS1625P is a surface mount resistor designed with 4 pads for Kelvin connection. Utilizing VFR's (Vishay Foil Resistors') Bulk Metal® Foil as the resistance element, it provides performance capabilities far greater than other resistor technologies can supply in a product of comparable size.

The key performance of the new VCS1625P is its high rated power up to 1W. This small device dissipates heat almost entirely through the pads so surface mount users are encouraged to be generous with the board's pads and traces. Gold terminations are available on special order.

The four terminal device separates the current leads from the voltage sensing leads. This configuration eliminates the effect of the lead wire resistance from points A to B and C to D, allowing low TCR current sensing.

VFR's application engineering department is available to advise and to make recommendations. For non-standard technical requirements and special applications, please contact foil@vishaypg.com.

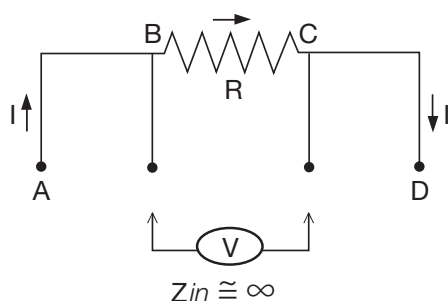

FEATURES

- Temperature coefficient of resistance (TCR): ± 2 ppm/ $^{\circ}$ C typical (- 55 $^{\circ}$ C to + 125 $^{\circ}$ C, + 25 $^{\circ}$ C ref.) (see table 1)
- Resistance range: 0.01 Ω to 10 Ω (for higher or lower values, please contact Application Engineering)
- Vishay Foil resistors are not restricted to standard values, we can supply specific "as required" values at no extra cost or delivery (e.g. 1.234 Ω vs. 1 Ω)
- Resistance tolerance: to $\pm 0.2\%$ (0.05% is also available)
- Load life stability: 0.015 % at 70 $^{\circ}$ C, 2000 h at rated power
- Thermal EMF: 0.05 μ V/ $^{\circ}$ C typical
- Electrostatic discharge (ESD) at least to 25 kV
- Short time overload < 0.005 %
- Thermal stabilization time < 1 s (nominal value achieved within 10 ppm of steady state value)
- Power rating: to 1 W at + 70 $^{\circ}$ C (Figure 1)
- Non inductive: non capacitive design
- Rise time: 1 ns effectively no ringing
- Current rating: 5 A maximum
- Current noise: 0.010 μ V_{RMS}/V of applied voltage (< - 40 dB)
- Voltage coefficient: < 0.1 ppm/V
- Non inductive: < 0.08 μ H
- Non hot spot design
- Prototype quantities available in just 5 working days or sooner
- For better performances, please review the VCS1625ZP (Z-Foil) datasheet



RoHS*
COMPLIANT

TERMINATIONS

- Two lead (Pb)-free options are available: gold plated or tin plated
- Tin/lead plated

FIGURE 1 - POWER DERATING CURVE

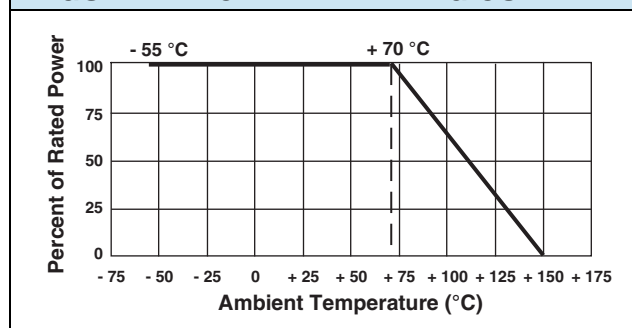

* Pb containing materials are not RoHS compliant, exemptions may apply

TABLE 1 - TOLERANCE AND TCR VS. RESISTANCE VALUE (- 55 °C to + 125 °C, + 25° Ref.)⁽¹⁾

VALUE (Ω)	TOLERANCE	TYPICAL TCR	MAXIMUM TCR	POWER RATING at + 70 °C ⁽²⁾	MAXIMUM CURRENT ⁽²⁾
> 2R000 to 10R000	0.2 %, 0.5 %, 1 %	± 2 ppm/°C	± 5 ppm/°C	1 W ⁽³⁾	5 A
> 0R500 to 2R000	0.5 %, 1 %	± 2 ppm/°C	± 10 ppm/°C		
> 0R100 to 0R500	1 %	± 2 ppm/°C	± 15 ppm/°C		
> 0R050 to 0R100	1 %	± 2 ppm/°C	± 20 ppm/°C		
> 0R030 to 0R050	1 %	± 2 ppm/°C	± 30 ppm/°C		
> 0R010 to 0R030	1 %	± 2 ppm/°C	± 50 ppm/°C		

Notes

⁽¹⁾Tighter performances are available. Please contact application engineering foil@vishaypg.com

⁽²⁾ Max Power or Max Current - whichever is lower

⁽³⁾ On FR4 PCB with solder pads per fig 2

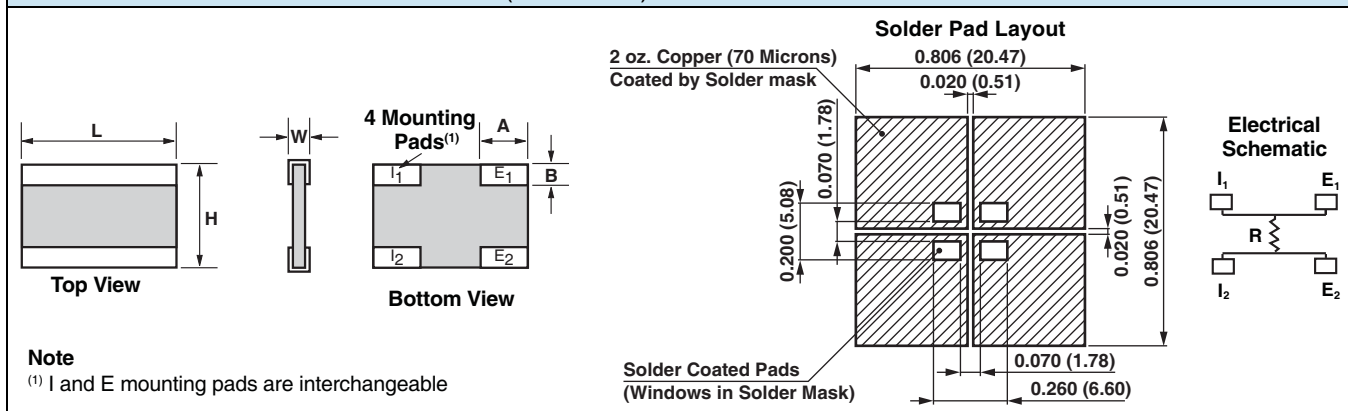
FIGURE 2 - DIMENSIONS in Inches (Millimeters)

Note

⁽¹⁾ I and E mounting pads are interchangeable

	INCHES	MILLIMETERS
L	0.250 ± 0.010	6.35 ± 0.25
H	0.160 ± 0.010	4.06 ± 0.25
W	0.040 maximum	1.02 maximum
A	0.080 ± 0.005	2.03 ± 0.13
B	0.040 ± 0.010	1.02 ± 0.25

FIGURE 3 - TRIMMING TO VALUES

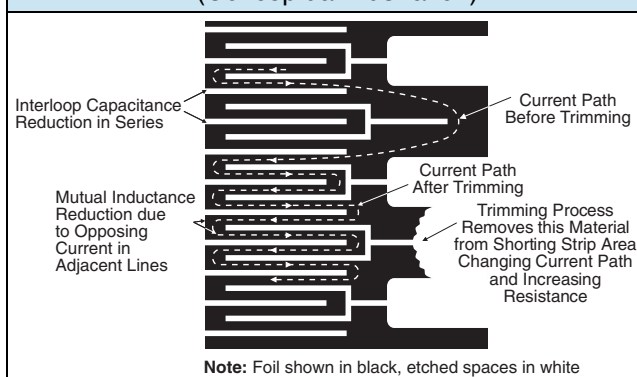
(Conceptual Illustration)*



* To acquire a precision resistance value, the Bulk Metal[®] Foil chip is trimmed by selectively removing built-in "shorting bars." To increase the resistance in known increments, marked areas are cut, producing progressively smaller increases in resistance. This method eliminates the effect of "hot spot" and improves the long term stability of the Foil chips.

FIGURE 4 - TYPICAL RESISTANCE VERSUS TEMPERATURE CURVE AND ITS CHORD SLOPES (TCR)

TABLE 2 - PERFORMANCE SPECIFICATIONS

TEST	MIL-PRF-55342 ΔR LIMITS	TYPICAL ΔR LIMITS	MAXIMUM ΔR LIMITS ⁽¹⁾
Thermal shock 5 x (- 65 °C to + 150 °C)	± 0.10 %	± 0.005 % (50 ppm)	± 0.01 % (100 ppm)
Low temperature operation, - 65 °C, 45 min at P _{nom}	± 0.10 %	± 0.005 % (50 ppm)	± 0.01 % (100 ppm)
Short time overload, 6.25 x rated power, 5 s	± 0.10 %	± 0.005 % (50 ppm)	± 0.02 % (200 ppm)
High temperature exposure, + 150 °C, 100 h	± 0.10 %	± 0.01 % (100 ppm)	± 0.02 % (200 ppm)
Resistance to soldering heat	± 0.2 %	± 0.01 % (100 ppm)	± 0.03 % (300 ppm)
Moisture resistance	± 0.2 %	± 0.01 % (100 ppm)	± 0.03 % (300 ppm)
Load life stability 2000 h at 70 °C at 1 W	± 0.5 %	± 0.015 % (150 ppm)	± 0.025 % (250 ppm)

Note

⁽¹⁾ Measurement error 0.001R

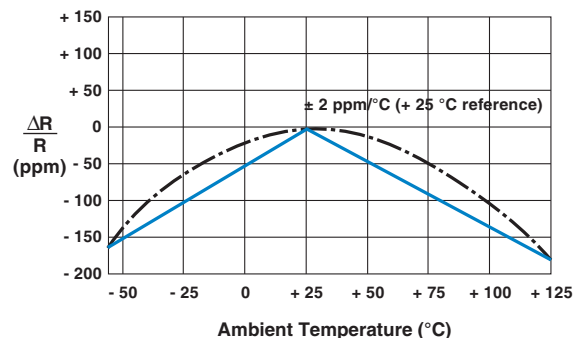
POST MANUFACTURING OPERATIONS OR PMO

Military applications can include requirements for performance under conditions of stress beyond the normal and over extended periods of time. This calls for more than just selecting a standard device and applying it to a circuit. The standard device may turn out to be all that is needed but an analysis of the projected service conditions should be made and it may well dictate a routine of stabilization known as post manufacturing operations or PMO. The PMO operations that will be discussed are only applicable to Foil resistors. They stabilize Foil resistors while they are harmful

to other types. Short time overload, accelerated load life, and temperature cycling are the three PMO exercises that do the most to remove the anomalies down the road. Foil resistors are inherently stable as manufactured. These PMO exercises are only of value on foil resistors and they improve the performance by small but significant amounts. Users are encouraged to contact VFR's application engineering department for assistance in choosing the PMO operations that are right for their application.

TABLE 3 - GLOBAL PART NUMBER INFORMATION

NEW GLOBAL PART NUMBER: Y08561R50000D9W (preferred part number format)

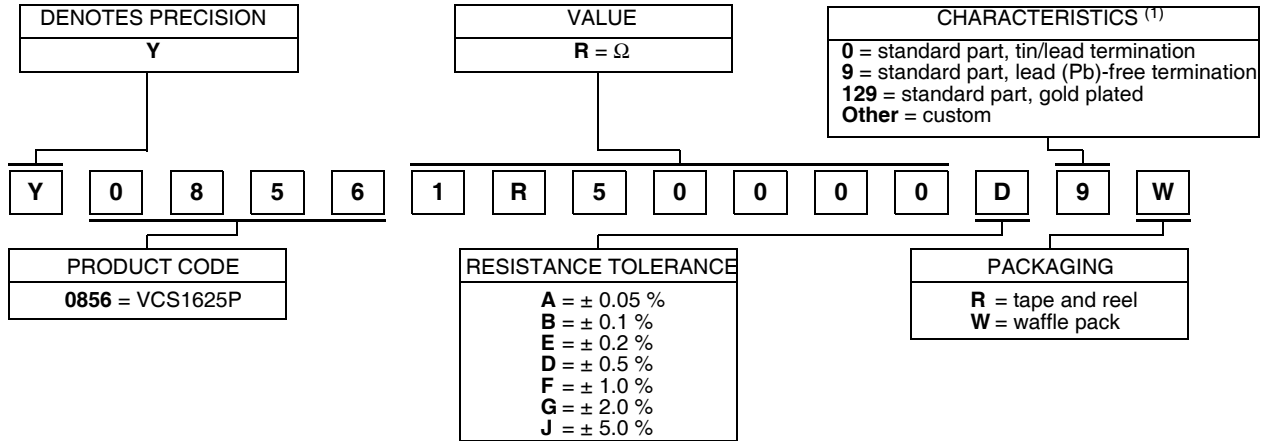

FOR EXAMPLE: ABOVE GLOBAL ORDER Y0856 1R50000 D 9 W:

TYPE: VCS1625P
 VALUE: 1.5 Ω
 ABSOLUTE TOLERANCE: ± 0.5 %
 TERMINATION: lead (Pb)-free
 PACKAGING: waffle pack

HISTORICAL PART NUMBER: VCS1625P 1R5000 TCR2 D S W (will continue to be used)

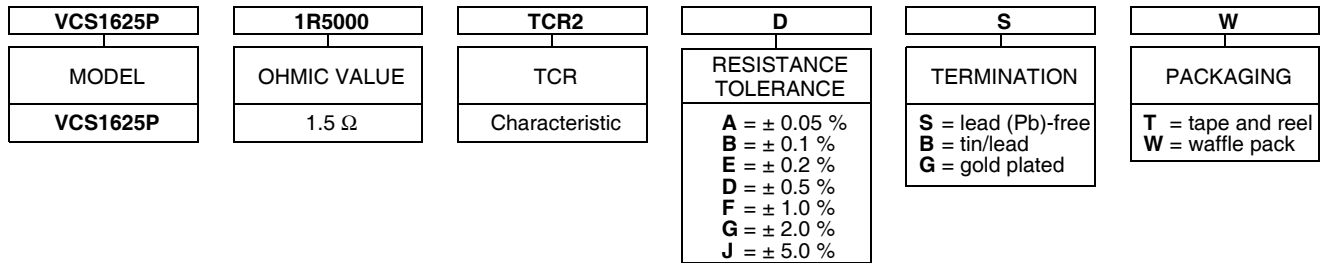

Note

(1) Application engineering release: for non-standard requests, please contact application engineering.



Disclaimer

ALL PRODUCTS, PRODUCT SPECIFICATIONS AND DATA ARE SUBJECT TO CHANGE WITHOUT NOTICE.

Vishay Precision Group, Inc., its affiliates, agents, and employees, and all persons acting on its or their behalf (collectively, "VPG"), disclaim any and all liability for any errors, inaccuracies or incompleteness contained herein or in any other disclosure relating to any product.

The product specifications do not expand or otherwise modify VPG's terms and conditions of purchase, including but not limited to, the warranty expressed therein.

VPG makes no warranty, representation or guarantee other than as set forth in the terms and conditions of purchase. **To the maximum extent permitted by applicable law, VPG disclaims (i) any and all liability arising out of the application or use of any product, (ii) any and all liability, including without limitation special, consequential or incidental damages, and (iii) any and all implied warranties, including warranties of fitness for particular purpose, non-infringement and merchantability.**

Information provided in datasheets and/or specifications may vary from actual results in different applications and performance may vary over time. Statements regarding the suitability of products for certain types of applications are based on VPG's knowledge of typical requirements that are often placed on VPG products. It is the customer's responsibility to validate that a particular product with the properties described in the product specification is suitable for use in a particular application. You should ensure you have the current version of the relevant information by contacting VPG prior to performing installation or use of the product, such as on our website at vpgsensors.com.

No license, express, implied, or otherwise, to any intellectual property rights is granted by this document, or by any conduct of VPG.

The products shown herein are not designed for use in life-saving or life-sustaining applications unless otherwise expressly indicated. Customers using or selling VPG products not expressly indicated for use in such applications do so entirely at their own risk and agree to fully indemnify VPG for any damages arising or resulting from such use or sale. Please contact authorized VPG personnel to obtain written terms and conditions regarding products designed for such applications.

Product names and markings noted herein may be trademarks of their respective owners.

Copyright Vishay Precision Group, Inc., 2014. All rights reserved.

Компания «Океан Электроники» предлагает заключение долгосрочных отношений при поставках импортных электронных компонентов на взаимовыгодных условиях!

Наши преимущества:

- Поставка оригинальных импортных электронных компонентов напрямую с производств Америки, Европы и Азии, а так же с крупнейших складов мира;
- Широкая линейка поставок активных и пассивных импортных электронных компонентов (более 30 млн. наименований);
- Поставка сложных, дефицитных, либо снятых с производства позиций;
- Оперативные сроки поставки под заказ (от 5 рабочих дней);
- Экспресс доставка в любую точку России;
- Помощь Конструкторского Отдела и консультации квалифицированных инженеров;
- Техническая поддержка проекта, помощь в подборе аналогов, поставка прототипов;
- Поставка электронных компонентов под контролем ВП;
- Система менеджмента качества сертифицирована по Международному стандарту ISO 9001;
- При необходимости вся продукция военного и аэрокосмического назначения проходит испытания и сертификацию в лаборатории (по согласованию с заказчиком);
- Поставка специализированных компонентов военного и аэрокосмического уровня качества (Xilinx, Altera, Analog Devices, Intersil, Interpoint, Microsemi, Actel, Aeroflex, Peregrine, VPT, Syfer, Eurofarad, Texas Instruments, MS Kennedy, Miteq, Cobham, E2V, MA-COM, Hittite, Mini-Circuits, General Dynamics и др.);

Компания «Океан Электроники» является официальным дистрибьютором и эксклюзивным представителем в России одного из крупнейших производителей разъемов военного и аэрокосмического назначения «JONHON», а так же официальным дистрибьютором и эксклюзивным представителем в России производителя высокотехнологичных и надежных решений для передачи СВЧ сигналов «FORSTAR».



JONHON

«JONHON» (основан в 1970 г.)

Разъемы специального, военного и аэрокосмического назначения:

(Применяются в военной, авиационной, аэрокосмической, морской, железнодорожной, горно- и нефтедобывающей отраслях промышленности)

«FORSTAR» (основан в 1998 г.)

ВЧ соединители, коаксиальные кабели, кабельные сборки и микроволновые компоненты:

(Применяются в телекоммуникациях гражданского и специального назначения, в средствах связи, РЛС, а так же военной, авиационной и аэрокосмической отраслях промышленности).



Телефон: 8 (812) 309-75-97 (многоканальный)

Факс: 8 (812) 320-03-32

Электронная почта: ocean@oceanchips.ru

Web: <http://oceanchips.ru/>

Адрес: 198099, г. Санкт-Петербург, ул. Калинина, д. 2, корп. 4, лит. А