

SDQ

Low-profile dual winding shielded drum inductor/transformer

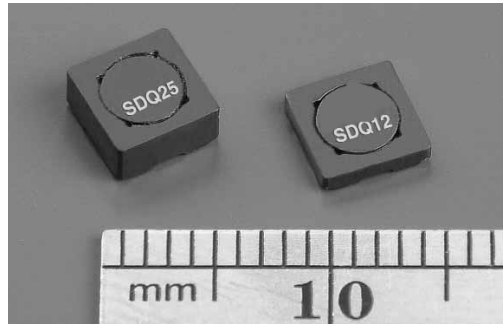

Applications

- Transformer: (1:1), SEPIC, flyback
- Buck, boost, coupled inductor
- Mobile phones
- Notebook and laptop power
- Digital cameras
- Media players
- PCMCIA cards
- GPS systems

Product features

- Dual winding inductors that can be used as either a single inductor, or in coupled inductor/transformer applications (1:1 turns ratio)
- Windings can be connected in series or parallel, offering a broad range of inductance and current ratings
- Current range from 0.063 A to 6.43 A
- Inductance range from 0.47 μ H to 4.03 mH
- Ferrite shielded, low EMI
- Ferrite core material
- 500 Vdc isolation between windings

Environmental Data

- Storage temperature range (Component): -40 °C to +125 °C
- Operating temperature range: -40 °C to +125 °C (ambient plus self-temperature rise)
- Solder reflow temperature: J-STD-020 (latest revision) compliant



Product specifications

Part Number	Rated Inductance (μH)	Part Marking	Parallel Ratings					Series Ratings				
			OCL ⁽¹⁾ ±20% (μH)	I _{rms} ⁽²⁾ (A)	I _{sat} ⁽³⁾ (A)	DCR ⁽⁴⁾ (Ω) typ.	Volts ⁽⁵⁾ (u-sec) typ.	OCL ⁽¹⁾ ±20% (μH)	I _{rms} ⁽²⁾ (A)	I _{sat} ⁽³⁾ (A)	DCR Ω (4) typ.	Volts ⁽⁵⁾ (u-sec) typ.
SDQ12-R47-R	0.47	A	0.49±30%	2.78	4.34	0.0325	2.45	1.96±30%	1.39	2.17	0.1298	4.90
SDQ12-1R0-R	1	B	0.81	2.49	3.38	0.0403	3.15	3.24	1.25	1.69	0.1611	6.30
SDQ12-1R5-R	1.5	C	1.69	1.69	2.34	0.0870	4.55	6.76	0.847	1.17	0.3481	9.10
SDQ12-2R2-R	2.2	D	2.25	1.60	2.03	0.0977	5.25	9.00	0.800	1.01	0.3908	10.5
SDQ12-3R3-R	3.3	E	3.61	1.28	1.60	0.1527	6.65	14.44	0.640	0.800	0.6106	13.3
SDQ12-4R7-R	4.7	F	4.41	1.12	1.45	0.1990	7.35	17.64	0.560	0.724	0.7959	14.7
SDQ12-6R2-R	6.2	G	6.25	1.02	1.22	0.2387	8.75	25.00	0.512	0.608	0.9548	17.5
SDQ12-8R2-R	8.2	H	8.41	0.868	1.05	0.3318	10.15	33.64	0.434	0.524	1.33	20.3
SDQ12-100-R	10	J	9.61	0.831	0.981	0.3620	10.85	38.44	0.416	0.490	1.45	21.7
SDQ12-150-R	15	K	15.21	0.658	0.779	0.5766	13.65	60.84	0.329	0.390	2.31	27.3
SDQ12-220-R	22	L	22.09	0.548	0.647	0.8332	16.45	88.36	0.274	0.323	3.33	32.9
SDQ12-330-R	33	M	32.49	0.439	0.533	1.29	19.95	130.0	0.220	0.267	5.18	39.9
SDQ12-470-R	47	N	47.61	0.401	0.441	1.55	24.15	190.4	0.201	0.220	6.21	48.3
SDQ12-680-R	68	O	68.89	0.326	0.366	2.36	29.05	275.6	0.163	0.183	9.43	58.1
SDQ12-820-R	82	P	82.81	0.309	0.334	2.62	31.85	331.2	0.154	0.167	10.49	63.7
SDQ25-R47-R	0.47	A	0.392±30%	3.71	6.43	0.0181	2.31	1.57±30%	1.86	3.21	0.0725	4.62
SDQ25-R82-R	0.82	B	0.648±30%	3.37	5.00	0.0221	2.97	2.59±30%	1.68	2.50	0.0883	5.94
SDQ25-1R0-R	1	C	0.97	3.15	4.09	0.0252	3.63	3.87	1.58	2.05	0.1007	7.26
SDQ25-1R5-R	1.5	D	1.35	2.97	3.46	0.0283	4.29	5.41	1.49	1.73	0.1130	8.58
SDQ25-2R2-R	2.2	E	2.31	2.67	2.65	0.0351	5.61	9.25	1.34	1.32	0.1402	11.2
SDQ25-3R3-R	3.3	F	2.89	2.50	2.37	0.0399	6.27	11.55	1.25	1.18	0.1595	12.5
SDQ25-4R7-R	4.7	G	5	1.96	1.80	0.0653	8.25	20.00	0.98	0.900	0.2612	16.5
SDQ25-6R8-R	6.8	H	6.73	1.84	1.55	0.0741	9.57	26.91	0.918	0.776	0.2964	19.1
SDQ25-8R2-R	8.2	J	8.71	1.57	1.36	0.1015	10.9	34.85	0.785	0.682	0.4059	21.8
SDQ25-100-R	10	K	9.8	1.53	1.29	0.1068	11.6	39.20	0.765	0.643	0.4273	23.1
SDQ25-150-R	15	L	14.79	1.24	1.05	0.1632	14.2	59.17	0.619	0.523	0.6526	28.4
SDQ25-220-R	22	M	22.47	1.01	0.849	0.2431	17.5	89.89	0.507	0.425	0.9724	35.0
SDQ25-330-R	33	N	33.8	0.812	0.692	0.3795	21.5	135.2	0.406	0.346	1.52	42.9
SDQ25-470-R	47	O	47.43	0.749	0.584	0.4461	25.4	189.7	0.374	0.292	1.78	50.8
SDQ25-680-R	68	P	69.19	0.603	0.484	0.6865	30.7	276.8	0.302	0.242	2.75	61.4
SDQ25-820-R	82	Q	81.61	0.580	0.446	0.7435	33.3	326.4	0.290	0.223	2.97	66.7
SDQ25-101-R	100	R	98.57	0.499	0.405	1.00	36.6	394.3	0.249	0.203	4.02	73.3
SDQ25-151-R	150	S	150.2	0.408	0.328	1.50	45.2	600.6	0.204	0.164	6.00	90.4
SDQ25-221-R	220	T	223.1	0.326	0.269	2.36	55.1	892.4	0.163	0.135	9.42	110
SDQ25-331-R	330	U	329.7	0.292	0.222	2.93	67.0	1318.7	0.146	0.111	11.71	134
SDQ25-471-R	470	V	472.4	0.243	0.185	4.25	80.2	1889.6	0.121	0.093	16.99	160
SDQ25-681-R	680	W	677.4	0.197	0.155	6.45	96.0	2709.8	0.098	0.077	25.78	192
SDQ25-821-R	820	X	824.3	0.186	0.140	7.25	106	3297.3	0.093	0.070	28.99	212
SDQ25-102-R	1000	Y	1008.2	0.160	0.127	9.82	117	4032.8	0.080	0.063	39.26	234

(1) Test Parameters: 100 kHz, 0.25 Vrms 0.0 Adc

(2) I_{rms}: DC current for approximately ΔT of 40 °C without core loss. It is recommended that the temperature of the part not to exceed +125 °C. Derating is necessary for AC currents

(3) I_{sat}: Peak current for approximately 30% rolloff @ +20 °C

(4) DCR limits @ +20 °C

(5) Applied Volt-Time product (V-μs) across the inductor at 100 kHz necessary to generate a core loss equal to 10% of the total losses for a 40 °C temperature rise. Derating of the I_{rms} is required to prevent excessive temperature rise.

Part Number Definition:

SDQ12-XXX-R

SDQ12 = Product code and Size

XXX = Inductance in uH, R = Decimal point

If no R is present, third character = # of zeros.

-R suffix indicated RoHS compliant

Dimensions- mm

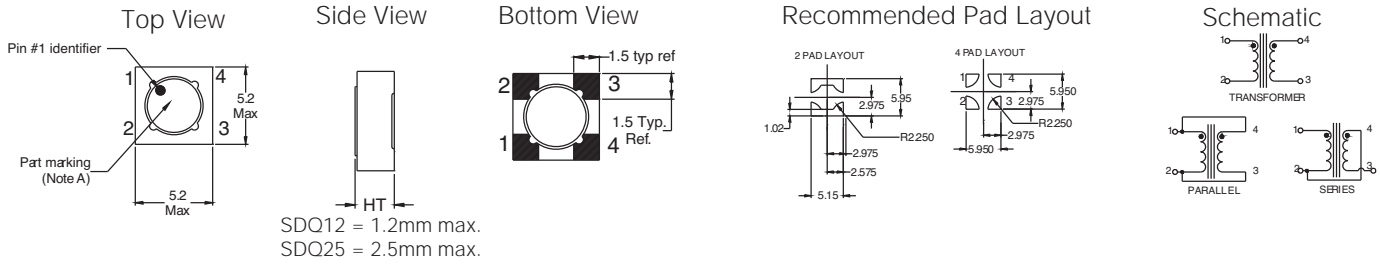

Part marking: Line 1 (1st digit inductance value per part marking designator in chart above) (2nd digit is a bi-weekly production date code) (3rd digit is the last digit of the year produced)
Line 2: xx (indicates the product size code)
Do not route traces or vias underneath the inductor

Packaging- mm

SDQ12

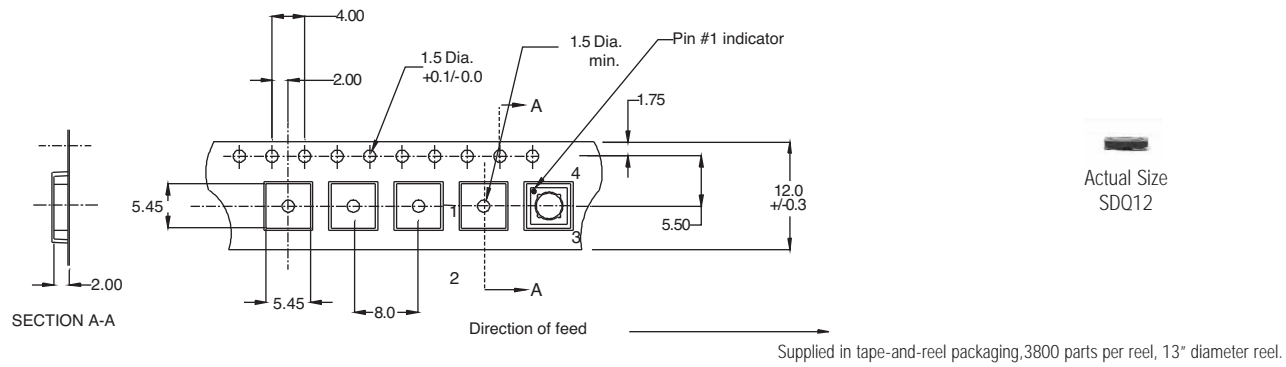

SDQ25

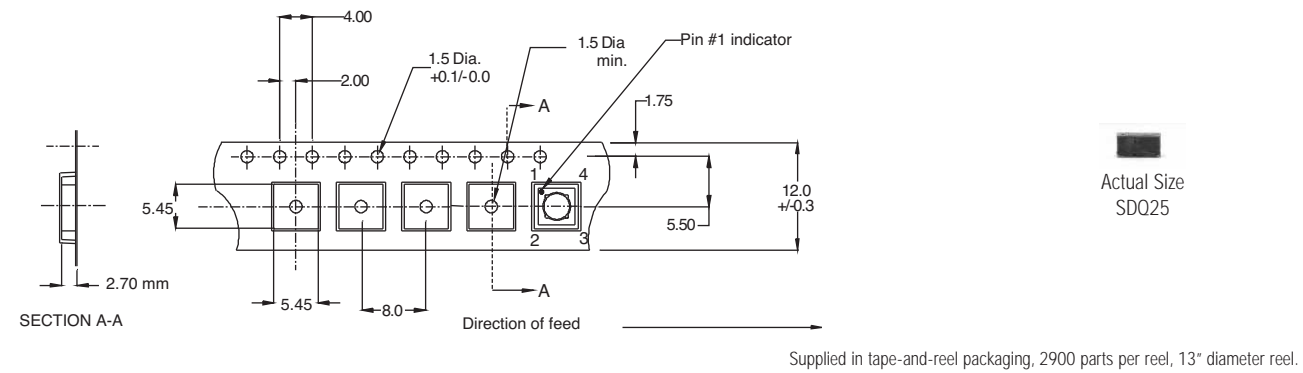

Core loss

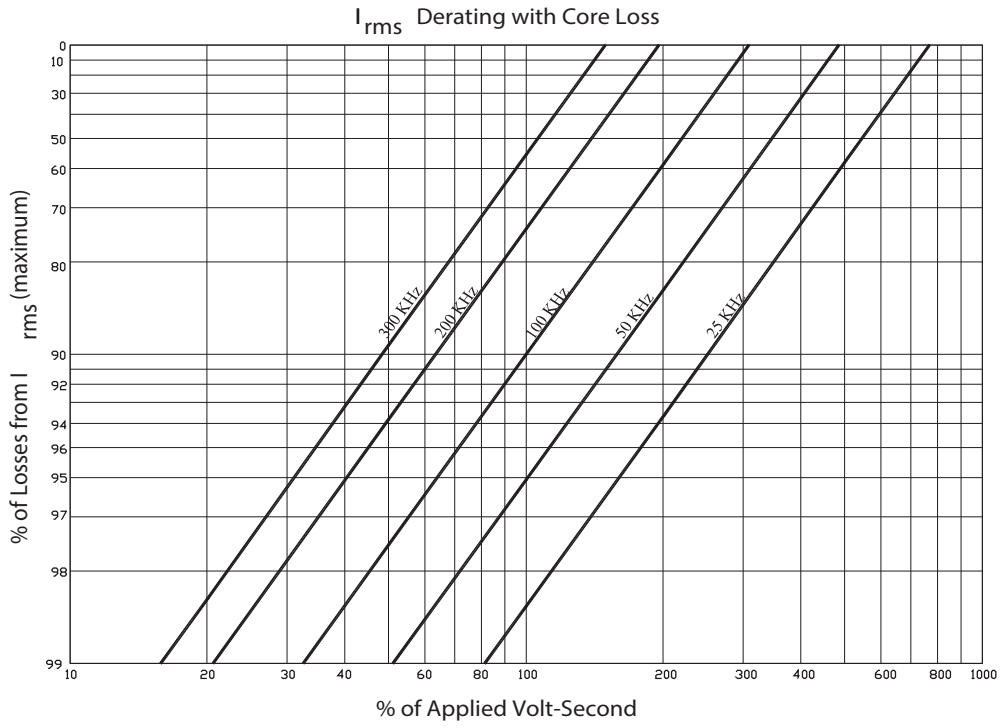

Inductance characteristics

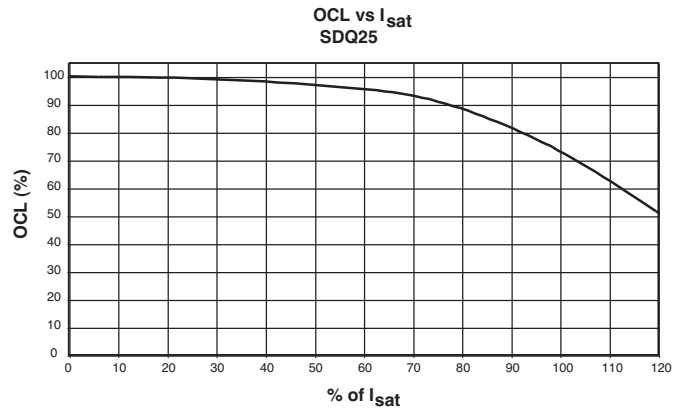
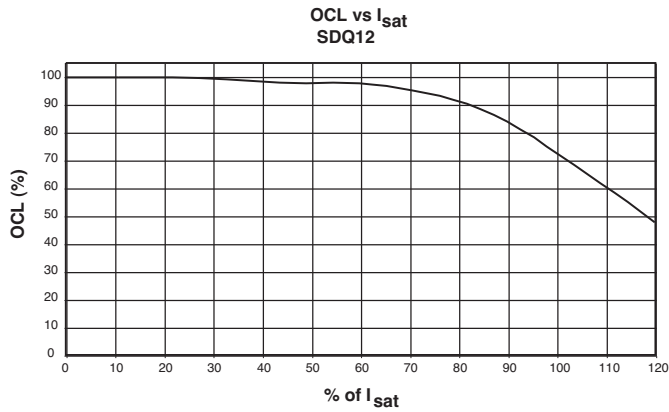

Solder reflow profile

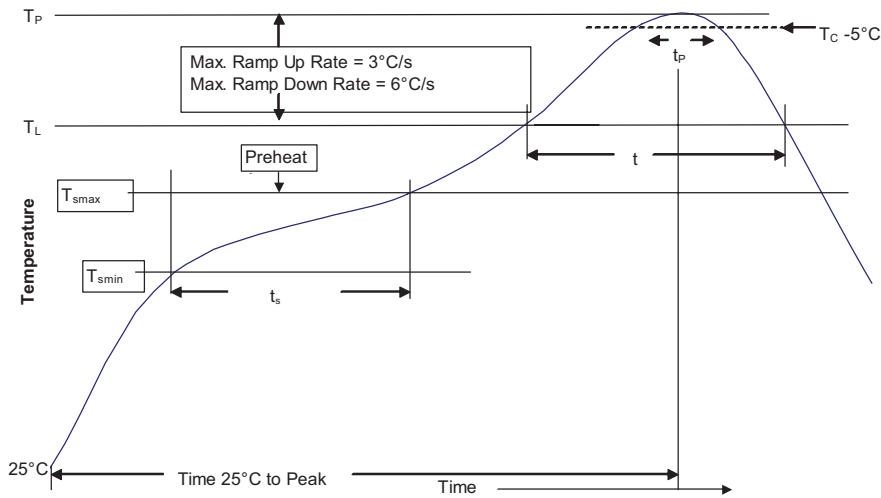

Table 1 - Standard SnPb Solder (T_C)

Package Thickness	Volume mm ³ <350	Volume mm ³ ≥350
<2.5mm)	235°C	220°C
≥2.5mm	220°C	220°C

Table 2 - Lead (Pb) Free Solder (T_C)

Package Thickness	Volume mm ³ <350	Volume mm ³ 350 - 2000	Volume mm ³ >2000
<1.6mm	260°C	260°C	260°C
1.6 - 2.5mm	260°C	250°C	245°C
>2.5mm	250°C	245°C	245°C

Reference JEDEC J-STD-020

Profile Feature	Standard SnPb Solder	Lead (Pb) Free Solder
Preheat and Soak		
• Temperature min. (T _{smin})	100°C	150°C
• Temperature max. (T _{smax})	150°C	200°C
• Time (T _{smin} to T _{smax}) (t _s)	60-120 Seconds	60-120 Seconds
Average ramp up rate T _{smax} to T _p	3°C/ Second Max.	3°C/ Second Max.
Liquidous temperature (T _L)	183°C	217°C
Time at liquidous (t _L)	60-150 Seconds	60-150 Seconds
Peak package body temperature (T _p)*	Table 1	Table 2
Time (t _p)** within 5 °C of the specified classification temperature (T _C)	20 Seconds**	30 Seconds**
Average ramp-down rate (T _p to T _{smax})	6°C/ Second Max.	6°C/ Second Max.
Time 25°C to Peak Temperature	6 Minutes Max.	8 Minutes Max.

* Tolerance for peak profile temperature (T_p) is defined as a supplier minimum and a user maximum.

** Tolerance for time at peak profile temperature (t_p) is defined as a supplier minimum and a user maximum.

Life Support Policy: Eaton does not authorize the use of any of its products for use in life support devices or systems without the express written approval of an officer of the Company. Life support systems are devices which support or sustain life, and whose failure to perform, when properly used in accordance with instructions for use provided in the labeling, can be reasonably expected to result in significant injury to the user.

Eaton reserves the right, without notice, to change design or construction of any products and to discontinue or limit distribution of any products. Eaton also reserves the right to change or update, without notice, any technical information contained in this bulletin.

Eaton
Electronics Division
 1000 Eaton Boulevard
 Cleveland, OH 44122
 United States
www.eaton.com/electronics

© 2017 Eaton
 All Rights Reserved
 Printed in USA
 Publication No. 4339 SB-BU08352
 August 2017

Eaton is a registered trademark.

All other trademarks are property of their respective owners.

Компания «Океан Электроники» предлагает заключение долгосрочных отношений при поставках импортных электронных компонентов на взаимовыгодных условиях!

Наши преимущества:

- Поставка оригинальных импортных электронных компонентов напрямую с производств Америки, Европы и Азии, а так же с крупнейших складов мира;
- Широкая линейка поставок активных и пассивных импортных электронных компонентов (более 30 млн. наименований);
- Поставка сложных, дефицитных, либо снятых с производства позиций;
- Оперативные сроки поставки под заказ (от 5 рабочих дней);
- Экспресс доставка в любую точку России;
- Помощь Конструкторского Отдела и консультации квалифицированных инженеров;
- Техническая поддержка проекта, помощь в подборе аналогов, поставка прототипов;
- Поставка электронных компонентов под контролем ВП;
- Система менеджмента качества сертифицирована по Международному стандарту ISO 9001;
- При необходимости вся продукция военного и аэрокосмического назначения проходит испытания и сертификацию в лаборатории (по согласованию с заказчиком);
- Поставка специализированных компонентов военного и аэрокосмического уровня качества (Xilinx, Altera, Analog Devices, Intersil, Interpoint, Microsemi, Actel, Aeroflex, Peregrine, VPT, Syfer, Eurofarad, Texas Instruments, MS Kennedy, Miteq, Cobham, E2V, MA-COM, Hittite, Mini-Circuits, General Dynamics и др.);

Компания «Океан Электроники» является официальным дистрибьютором и эксклюзивным представителем в России одного из крупнейших производителей разъемов военного и аэрокосмического назначения «**JONHON**», а так же официальным дистрибьютором и эксклюзивным представителем в России производителя высокотехнологичных и надежных решений для передачи СВЧ сигналов «**FORSTAR**».



JONHON

«**JONHON**» (основан в 1970 г.)

Разъемы специального, военного и аэрокосмического назначения:

(Применяются в военной, авиационной, аэрокосмической, морской, железнодорожной, горно- и нефтедобывающей отраслях промышленности)

«**FORSTAR**» (основан в 1998 г.)

ВЧ соединители, коаксиальные кабели,
кабельные сборки и микроволновые компоненты:

(Применяются в телекоммуникациях гражданского и специального назначения, в средствах связи, РЛС, а так же военной, авиационной и аэрокосмической отраслях промышленности).



Телефон: 8 (812) 309-75-97 (многоканальный)

Факс: 8 (812) 320-03-32

Электронная почта: ocean@oceanchips.ru

Web: <http://oceanchips.ru/>

Адрес: 198099, г. Санкт-Петербург, ул. Калинина, д. 2, корп. 4, лит. А