

400W, 600W SURFACE MOUNT TRANSIENT VOLTAGE SUPPRESSOR
Features

- 400, 600W Peak Pulse Power Dissipation
- 70V Standoff Voltage
- 100V Maximum Clamping Voltage - A requirement of many - 48V Backplane Telecom Applications
- Glass Passivated Die Construction
- Fast Response Time: Typically less than 1 ps
- **Lead Free Finish, RoHS Compliant (Note 4)**
- **Green Molding Compound (No Halogen and Antimony) (Note 5)**
- **Qualified to AEC-Q101 Standards for High Reliability**

Mechanical Data

- Case: SMA / SMB
- Case Material: Molded Plastic. UL Flammability Classification Rating 94V-0
- Moisture Sensitivity: Level 1 per J-STD-020D
- Terminals: Lead Free Plating (Matte Tin Finish). Solderable per MIL-STD-202, Method 208
- Polarity Indicator: Cathode Band
- Marking Information: See Page 2
- Ordering Information: See Page 2
- Weight: SMA 0.064 grams (approximate)
SMB 0.093 grams (approximate)

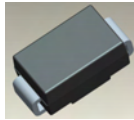

Top View

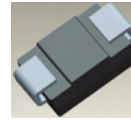

Bottom View

Maximum Ratings @ $T_A = 25^\circ\text{C}$ unless otherwise specified

Characteristic	Symbol	SMAT70A	SMBT70A	Unit
Peak Pulse Power Dissipation (Non repetitive current pulse derated above $T_A = 25^\circ\text{C}$)	P_{PK}	400	600	W
Peak Forward Surge Current, 8.3ms Single Half Sine Wave Superimposed on Rated Load (Note 2)	I_{FSM}	40	100	A
Instantaneous Forward Voltage @ $I_{PP} = 35\text{A}$ (Note 2)	V_F	3.5		V

Thermal Characteristics

Characteristic	Symbol	Value	Unit
Operating and Storage Temperature Range	T_J, T_{STG}	-55 to +150	$^\circ\text{C}$

Electrical Characteristics @ $T_A = 25^\circ\text{C}$ unless otherwise specified

Part Number	Reverse Standoff Voltage	Breakdown Voltage V_{BR} @ I_T (Note 3)		Test Current	Max. Reverse Leakage @ V_{RWM}	Max. Clamping Voltage @ I_{PP}	Max. Peak Pulse Current I_{PP}	Typical Junction Capacitance (Note 3)	Typical Voltage Temp. Variation of V_{BR}	Marking Code
	V_{RWM} (V)	Min (V)	Max (V)	I_T (mA)	I_R (μA)	V_C (V)	(A)	(pF)	mV/ $^\circ\text{C}$	
SMAT70A	70	77.8	89.5	1.0	5.0	100	3.5	140	80	KEX
SMBT70A	70	77.8	89.5	1.0	5.0	100	5.3	290	80	NPX

- Notes:
1. Measured with 8.3ms single half sine-wave. Duty cycle = 4 pulses per minute maximum.
 2. V_{BR} measured with I_T current pulse = 300 μs .
 3. $f = 1\text{MHz}$, $V_R = 0\text{VDC}$.
 4. EU Directive 2002/95/EC (RoHS). All applicable RoHS exemptions applied. Please visit our website at http://www.diodes.com/quality/lead_free.html.
 5. Product manufactured with Data Code 0924 (week 24, 2009) and newer are built with Green Molding Compound.

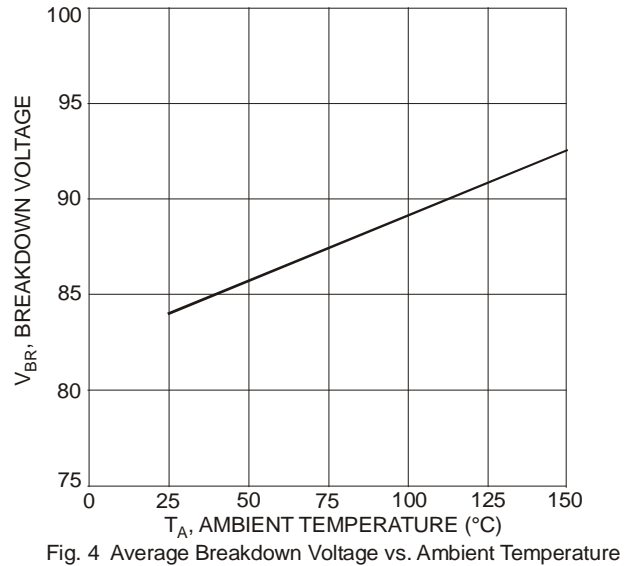
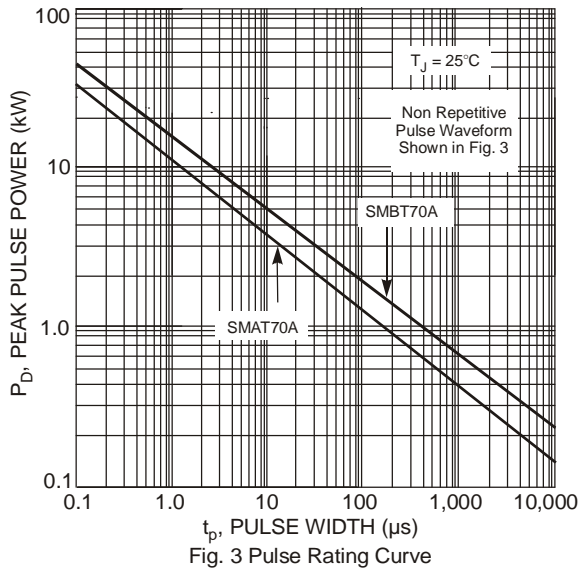
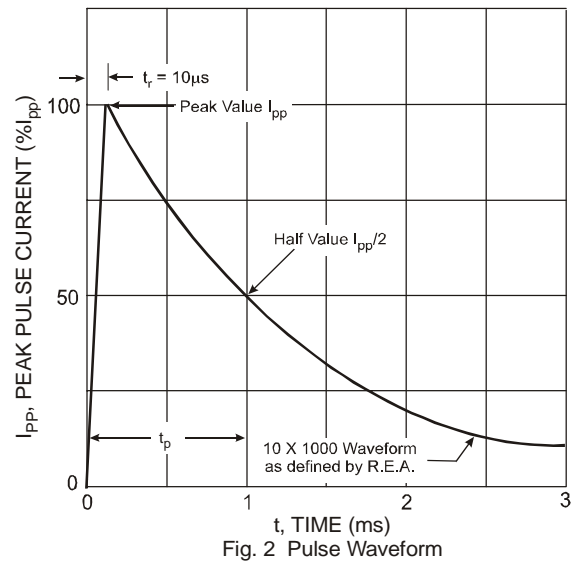
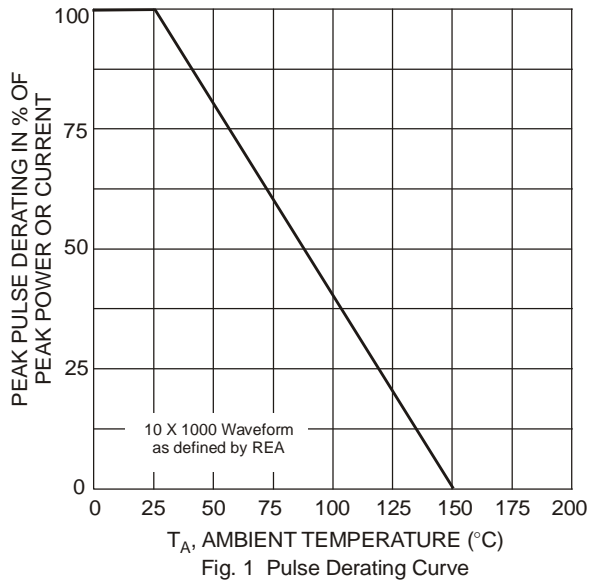

Ordering Information (Note 6)

Part Number	Case	Packaging
SMAT70A-13-F	SMA	5000/Tape & Reel
SMBT70A-13-F	SMB	3000/Tape & Reel

Notes: 6. For packaging details, go to our website at <http://www.diodes.com/datasheets/ap02007.pdf>.

Marking Information

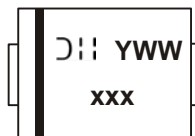

xxx = Product type marking code
See Electrical Characteristics Table
DII = Manufacturers' code marking
YWW = Date code marking
Y = Last digit of year ex: 2 for 2002
WW = Week code 01 to 52

Package Outline Dimensions

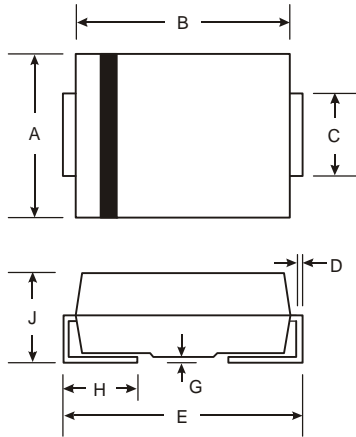

SMA		
Dim	Min	Max
A	2.29	2.92
B	4.00	4.60
C	1.27	1.63
D	0.15	0.31
E	4.80	5.59
G	0.05	0.20
H	0.76	1.52
J	2.01	2.30
All Dimensions in mm		

SMB		
Dim	Min	Max
A	3.30	3.94
B	4.06	4.57
C	1.96	2.21
D	0.15	0.31
E	5.00	5.59
G	0.05	0.20
H	0.76	1.52
J	2.00	2.62
All Dimensions in mm		

Suggested Pad Layout

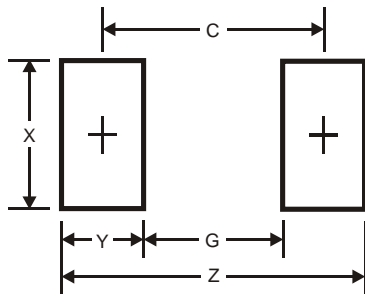

SMA Dimensions	Value (in mm)
Z	6.5
G	1.5
X	1.7
Y	2.5
C	4.0

SMB Dimensions	Value (in mm)
Z	6.7
G	1.8
X	2.3
Y	2.5
C	4.3

IMPORTANT NOTICE

DIODES INCORPORATED MAKES NO WARRANTY OF ANY KIND, EXPRESS OR IMPLIED, WITH REGARDS TO THIS DOCUMENT, INCLUDING, BUT NOT LIMITED TO, THE IMPLIED WARRANTIES OF MERCHANTABILITY AND FITNESS FOR A PARTICULAR PURPOSE (AND THEIR EQUIVALENTS UNDER THE LAWS OF ANY JURISDICTION).

Diodes Incorporated and its subsidiaries reserve the right to make modifications, enhancements, improvements, corrections or other changes without further notice to this document and any product described herein. Diodes Incorporated does not assume any liability arising out of the application or use of this document or any product described herein; neither does Diodes Incorporated convey any license under its patent or trademark rights, nor the rights of others. Any Customer or user of this document or products described herein in such applications shall assume all risks of such use and will agree to hold Diodes Incorporated and all the companies whose products are represented on Diodes Incorporated website, harmless against all damages.

Diodes Incorporated does not warrant or accept any liability whatsoever in respect of any products purchased through unauthorized sales channel. Should Customers purchase or use Diodes Incorporated products for any unintended or unauthorized application, Customers shall indemnify and hold Diodes Incorporated and its representatives harmless against all claims, damages, expenses, and attorney fees arising out of, directly or indirectly, any claim of personal injury or death associated with such unintended or unauthorized application.

Products described herein may be covered by one or more United States, international or foreign patents pending. Product names and markings noted herein may also be covered by one or more United States, international or foreign trademarks.

LIFE SUPPORT

Diodes Incorporated products are specifically not authorized for use as critical components in life support devices or systems without the express written approval of the Chief Executive Officer of Diodes Incorporated. As used herein:

- A. Life support devices or systems are devices or systems which:
 - 1. are intended to implant into the body, or
 - 2. support or sustain life and whose failure to perform when properly used in accordance with instructions for use provided in the labeling can be reasonably expected to result in significant injury to the user.
- B. A critical component is any component in a life support device or system whose failure to perform can be reasonably expected to cause the failure of the life support device or to affect its safety or effectiveness.

Customers represent that they have all necessary expertise in the safety and regulatory ramifications of their life support devices or systems, and acknowledge and agree that they are solely responsible for all legal, regulatory and safety-related requirements concerning their products and any use of Diodes Incorporated products in such safety-critical, life support devices or systems, notwithstanding any devices- or systems-related information or support that may be provided by Diodes Incorporated. Further, Customers must fully indemnify Diodes Incorporated and its representatives against any damages arising out of the use of Diodes Incorporated products in such safety-critical, life support devices or systems.

Copyright © 2009, Diodes Incorporated

www.diodes.com

Компания «Океан Электроники» предлагает заключение долгосрочных отношений при поставках импортных электронных компонентов на взаимовыгодных условиях!

Наши преимущества:

- Поставка оригинальных импортных электронных компонентов напрямую с производств Америки, Европы и Азии, а так же с крупнейших складов мира;
- Широкая линейка поставок активных и пассивных импортных электронных компонентов (более 30 млн. наименований);
- Поставка сложных, дефицитных, либо снятых с производства позиций;
- Оперативные сроки поставки под заказ (от 5 рабочих дней);
- Экспресс доставка в любую точку России;
- Помощь Конструкторского Отдела и консультации квалифицированных инженеров;
- Техническая поддержка проекта, помощь в подборе аналогов, поставка прототипов;
- Поставка электронных компонентов под контролем ВП;
- Система менеджмента качества сертифицирована по Международному стандарту ISO 9001;
- При необходимости вся продукция военного и аэрокосмического назначения проходит испытания и сертификацию в лаборатории (по согласованию с заказчиком);
- Поставка специализированных компонентов военного и аэрокосмического уровня качества (Xilinx, Altera, Analog Devices, Intersil, Interpoint, Microsemi, Actel, Aeroflex, Peregrine, VPT, Syfer, Eurofarad, Texas Instruments, MS Kennedy, Miteq, Cobham, E2V, MA-COM, Hittite, Mini-Circuits, General Dynamics и др.);

Компания «Океан Электроники» является официальным дистрибьютором и эксклюзивным представителем в России одного из крупнейших производителей разъемов военного и аэрокосмического назначения «JONHON», а так же официальным дистрибьютором и эксклюзивным представителем в России производителя высокотехнологичных и надежных решений для передачи СВЧ сигналов «FORSTAR».



JONHON

«JONHON» (основан в 1970 г.)

Разъемы специального, военного и аэрокосмического назначения:

(Применяются в военной, авиационной, аэрокосмической, морской, железнодорожной, горно- и нефтедобывающей отраслях промышленности)

«FORSTAR» (основан в 1998 г.)

ВЧ соединители, коаксиальные кабели, кабельные сборки и микроволновые компоненты:

(Применяются в телекоммуникациях гражданского и специального назначения, в средствах связи, РЛС, а так же военной, авиационной и аэрокосмической отраслях промышленности).



Телефон: 8 (812) 309-75-97 (многоканальный)

Факс: 8 (812) 320-03-32

Электронная почта: ocean@oceanchips.ru

Web: <http://oceanchips.ru/>

Адрес: 198099, г. Санкт-Петербург, ул. Калинина, д. 2, корп. 4, лит. А