

DAP222, DAP202U

Preferred Device

Common Anode Silicon Dual Switching Diodes

These Common Anode Silicon Epitaxial Planar Dual Diodes are designed for use in ultra high speed switching applications. The DAP222 device is housed in the SC-75/SOT-416 package which is designed for low power surface mount applications, where board space is at a premium. The DAP202U device is housed in the SC-70/SOT-323 package.

Features

- Fast t_{rr}
- Low C_D
- Pb-Free Packages are Available

MAXIMUM RATINGS ($T_A = 25^\circ\text{C}$)

Rating	Symbol	Value	Unit
Reverse Voltage	V_R	80	Vdc
Peak Reverse Voltage	V_{RM}	80	Vdc
Forward Current	I_F	100	mAdc
Peak Forward Current	I_{FM}	300	mAdc
Peak Forward Surge Current	$I_{FSM}(1)$	2.0	Adc

THERMAL CHARACTERISTICS

Rating	Symbol	Max	Unit
Power Dissipation	P_D	150	mW
Junction Temperature	T_J	150	$^\circ\text{C}$
Storage Temperature	T_{stg}	-55 ~ +150	$^\circ\text{C}$

Maximum ratings are those values beyond which device damage can occur. Maximum ratings applied to the device are individual stress limit values (not normal operating conditions) and are not valid simultaneously. If these limits are exceeded, device functional operation is not implied, damage may occur and reliability may be affected.



ON Semiconductor®

<http://onsemi.com>

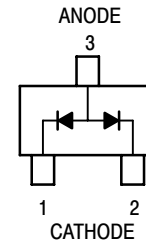

MARKING DIAGRAMS

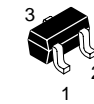

SC-75
CASE 463
STYLE 4

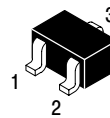
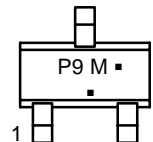

SC-70
CASE 419

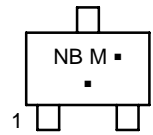

P9, NB = Device Codes
M = Date Code*
▪ = Pb-Free Package

(Note: Microdot may be in either location)

*Date Code orientation and/or orientation may vary depending upon manufacturing location.

ORDERING INFORMATION

Device	Package	Shipping†
DAP222	SC-75	3000 / Tape & Reel
DAP222G	SC-75 (Pb-Free)	3000 / Tape & Reel
DAP202U	SC-70	3000 / Tape & Reel
DAP202UG	SC-70 (Pb-Free)	3000 / Tape & Reel
DAP222T1	SC-75	3000 / Tape & Reel
DAP222T1G	SC-75 (Pb-Free)	3000 / Tape & Reel

†For information on tape and reel specifications, including part orientation and tape sizes, please refer to our Tape and Reel Packaging Specifications Brochure, BRD8011/D.

Preferred devices are recommended choices for future use and best overall value.

DAP222, DAP202U

ELECTRICAL CHARACTERISTICS (T_A = 25°C)

Characteristic	Symbol	Condition	Min	Max	Unit
Reverse Voltage Leakage Current	I _R	V _R = 70 V	-	0.1	μAdc
Forward Voltage	V _F	I _F = 100 mA	-	1.2	Vdc
Reverse Breakdown Voltage	V _R	I _R = 100 μA	80	-	Vdc
Diode Capacitance	C _D	V _R = 6.0 V, f = 1.0 MHz	-	3.5	pF
Reverse Recovery Time	DAP222	I _F = 5.0 mA, V _R = 6.0 V, R _L = 100 Ω, I _{rr} = 0.1 I _R	-	4.0	ns
	DAP202U		t _{rr} (2) t _{rr} (3)	I _F = 5.0 mA, V _R = 6.0 V, R _L = 50 Ω, I _{rr} = 0.1 I _R	

- t = 1 μS
- t_{rr} Test Circuit for DAP222 in Figure 4.
- t_{rr} Test Circuit for DAP202U in Figure 5.

TYPICAL ELECTRICAL CHARACTERISTICS

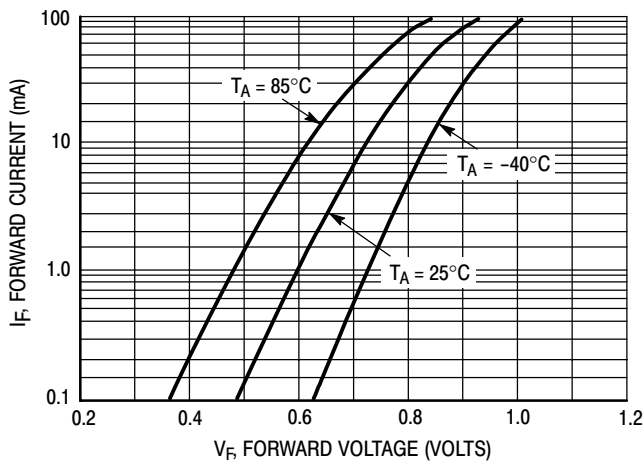

Figure 1. Forward Voltage

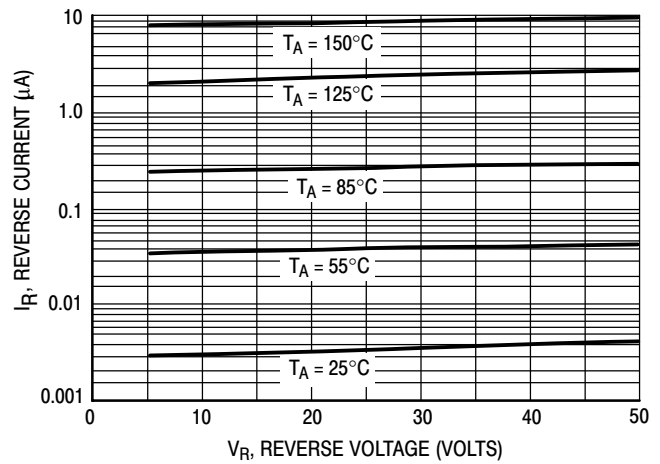

Figure 2. Reverse Current

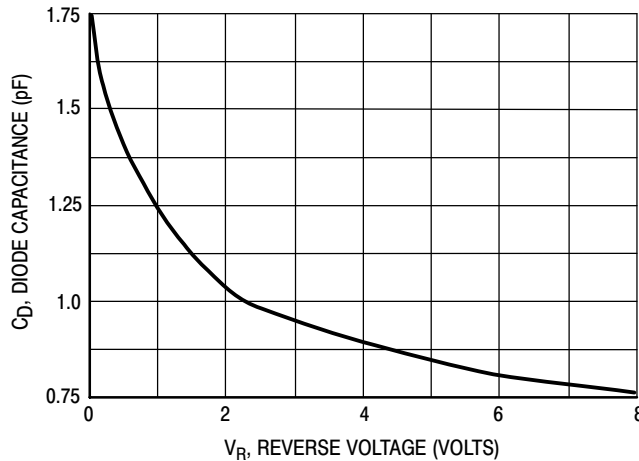
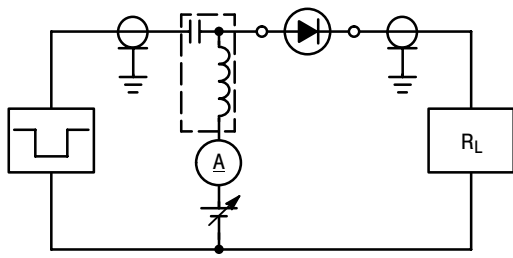
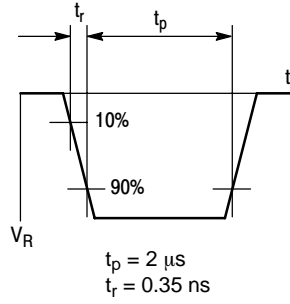

Figure 3. Diode Capacitance

DAP222, DAP202U



RECOVERY TIME EQUIVALENT TEST CIRCUIT



INPUT PULSE

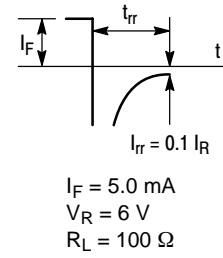

OUTPUT PULSE

Figure 4. Reverse Recovery Time Test Circuit for the DAP222

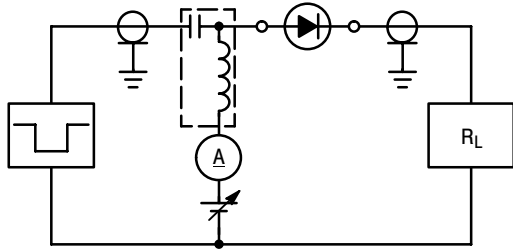

RECOVERY TIME EQUIVALENT TEST CIRCUIT

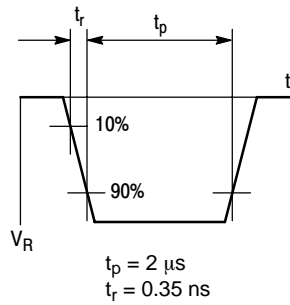

INPUT PULSE

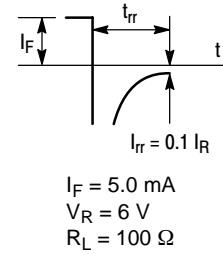

OUTPUT PULSE

Figure 5. Reverse Recovery Time Test Circuit for the DAP202U

DAP222, DAP202U

PACKAGE DIMENSIONS

SC-75 (SOT-416)
CASE 463-01
ISSUE F

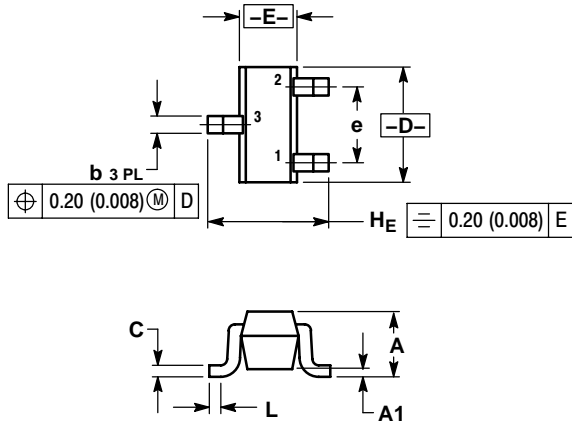

NOTES:

1. DIMENSIONING AND TOLERANCING PER ANSI Y14.5M, 1982.
2. CONTROLLING DIMENSION: MILLIMETER.

DIM	MILLIMETERS			INCHES		
	MIN	NOM	MAX	MIN	NOM	MAX
A	0.70	0.80	0.90	0.027	0.031	0.035
A1	0.00	0.05	0.10	0.000	0.002	0.004
b	0.15	0.20	0.30	0.006	0.008	0.012
C	0.10	0.15	0.25	0.004	0.006	0.010
D	1.55	1.60	1.65	0.059	0.063	0.067
E	0.70	0.80	0.90	0.027	0.031	0.035
e	1.00 BSC			0.04 BSC		
L	0.10	0.15	0.20	0.004	0.006	0.008
H _E	1.50	1.60	1.70	0.061	0.063	0.065

STYLE 4:

- PIN 1. CATHODE
- CATHODE
- ANODE

SOLDERING FOOTPRINT*

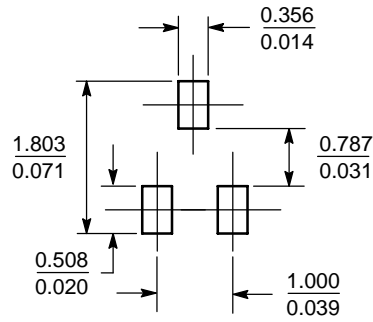

SCALE 10:1 $\left(\frac{\text{mm}}{\text{inches}} \right)$

*For additional information on our Pb-Free strategy and soldering details, please download the ON Semiconductor Soldering and Mounting Techniques Reference Manual, SOLDERRM/D.

DAP222, DAP202U

PACKAGE DIMENSIONS

SC-70 (SOT-323) CASE 419-04 ISSUE M

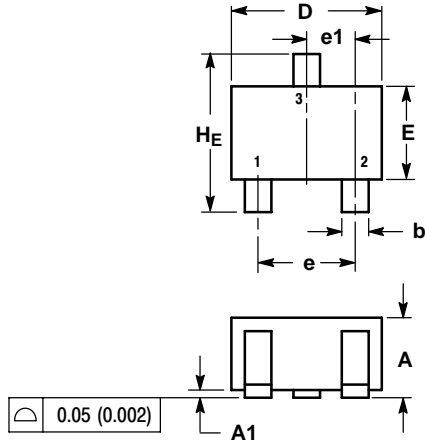

- NOTES:
1. DIMENSIONING AND TOLERANCING PER ANSI Y14.5M, 1982.
 2. CONTROLLING DIMENSION: INCH.

DIM	MILLIMETERS			INCHES		
	MIN	NOM	MAX	MIN	NOM	MAX
A	0.80	0.90	1.00	0.032	0.035	0.040
A1	0.00	0.05	0.10	0.000	0.002	0.004
A2	0.7 REF			0.028 REF		
b	0.30	0.35	0.40	0.012	0.014	0.016
c	0.10	0.18	0.25	0.004	0.007	0.010
D	1.80	2.10	2.20	0.071	0.083	0.087
E	1.15	1.24	1.35	0.045	0.049	0.053
e	1.20	1.30	1.40	0.047	0.051	0.055
e1	0.65 BSC			0.026 BSC		
L	0.425 REF			0.017 REF		
HE	2.00	2.10	2.40	0.079	0.083	0.095

SOLDERING FOOTPRINT*

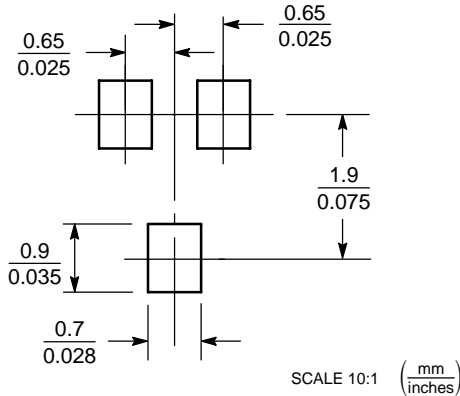

*For additional information on our Pb-Free strategy and soldering details, please download the ON Semiconductor Soldering and Mounting Techniques Reference Manual, SOLDERRM/D.

ON Semiconductor and are registered trademarks of Semiconductor Components Industries, LLC (SCILLC). SCILLC reserves the right to make changes without further notice to any products herein. SCILLC makes no warranty, representation or guarantee regarding the suitability of its products for any particular purpose, nor does SCILLC assume any liability arising out of the application or use of any product or circuit, and specifically disclaims any and all liability, including without limitation special, consequential or incidental damages. "Typical" parameters which may be provided in SCILLC data sheets and/or specifications can and do vary in different applications and actual performance may vary over time. All operating parameters, including "Typicals" must be validated for each customer application by customer's technical experts. SCILLC does not convey any license under its patent rights nor the rights of others. SCILLC products are not designed, intended, or authorized for use as components in systems intended for surgical implant into the body, or other applications intended to support or sustain life, or for any other application in which the failure of the SCILLC product could create a situation where personal injury or death may occur. Should Buyer purchase or use SCILLC products for any such unintended or unauthorized application, Buyer shall indemnify and hold SCILLC and its officers, employees, subsidiaries, affiliates, and distributors harmless against all claims, costs, damages, and expenses, and reasonable attorney fees arising out of, directly or indirectly, any claim of personal injury or death associated with such unintended or unauthorized use, even if such claim alleges that SCILLC was negligent regarding the design or manufacture of the part. SCILLC is an Equal Opportunity/Affirmative Action Employer. This literature is subject to all applicable copyright laws and is not for resale in any manner.

PUBLICATION ORDERING INFORMATION

LITERATURE FULFILLMENT:
Literature Distribution Center for ON Semiconductor
P.O. Box 61312, Phoenix, Arizona 85062-1312 USA
Phone: 480-829-7710 or 800-344-3860 Toll Free USA/Canada
Fax: 480-829-7709 or 800-344-3867 Toll Free USA/Canada
Email: orderlit@onsemi.com

N. American Technical Support: 800-282-9855 Toll Free USA/Canada
Japan: ON Semiconductor, Japan Customer Focus Center
2-9-1 Kamimeguro, Meguro-ku, Tokyo, Japan 153-0051
Phone: 81-3-5773-3850

ON Semiconductor Website: <http://onsemi.com>
Order Literature: <http://www.onsemi.com/litorder>

For additional information, please contact your local Sales Representative.

Компания «Океан Электроники» предлагает заключение долгосрочных отношений при поставках импортных электронных компонентов на взаимовыгодных условиях!

Наши преимущества:

- Поставка оригинальных импортных электронных компонентов напрямую с производств Америки, Европы и Азии, а так же с крупнейших складов мира;
- Широкая линейка поставок активных и пассивных импортных электронных компонентов (более 30 млн. наименований);
- Поставка сложных, дефицитных, либо снятых с производства позиций;
- Оперативные сроки поставки под заказ (от 5 рабочих дней);
- Экспресс доставка в любую точку России;
- Помощь Конструкторского Отдела и консультации квалифицированных инженеров;
- Техническая поддержка проекта, помощь в подборе аналогов, поставка прототипов;
- Поставка электронных компонентов под контролем ВП;
- Система менеджмента качества сертифицирована по Международному стандарту ISO 9001;
- При необходимости вся продукция военного и аэрокосмического назначения проходит испытания и сертификацию в лаборатории (по согласованию с заказчиком);
- Поставка специализированных компонентов военного и аэрокосмического уровня качества (Xilinx, Altera, Analog Devices, Intersil, Interpoint, Microsemi, Actel, Aeroflex, Peregrine, VPT, Syfer, Eurofarad, Texas Instruments, MS Kennedy, Miteq, Cobham, E2V, MA-COM, Hittite, Mini-Circuits, General Dynamics и др.);

Компания «Океан Электроники» является официальным дистрибьютором и эксклюзивным представителем в России одного из крупнейших производителей разъемов военного и аэрокосмического назначения «JONHON», а так же официальным дистрибьютором и эксклюзивным представителем в России производителя высокотехнологичных и надежных решений для передачи СВЧ сигналов «FORSTAR».



JONHON

«JONHON» (основан в 1970 г.)

Разъемы специального, военного и аэрокосмического назначения:

(Применяются в военной, авиационной, аэрокосмической, морской, железнодорожной, горно- и нефтедобывающей отраслях промышленности)

«FORSTAR» (основан в 1998 г.)

ВЧ соединители, коаксиальные кабели, кабельные сборки и микроволновые компоненты:

(Применяются в телекоммуникациях гражданского и специального назначения, в средствах связи, РЛС, а так же военной, авиационной и аэрокосмической отраслях промышленности).



Телефон: 8 (812) 309-75-97 (многоканальный)

Факс: 8 (812) 320-03-32

Электронная почта: ocean@oceanchips.ru

Web: <http://oceanchips.ru/>

Адрес: 198099, г. Санкт-Петербург, ул. Калинина, д. 2, корп. 4, лит. А