

## 14 + 1 channel buffers for TFT-LCD panels

Datasheet – production data

### Features

- Wide supply voltage: 5.5 V to 16.8 V
- Low operating current: 6 mA typical at 25 °C
- Gain bandwidth product: 1 MHz
- High current COM amplifier:  $\pm 100$  mA output current
- Industrial temperature range: -40 °C to +85 °C
- Small package: TQFP48
- Automotive qualification

### Application

- TFT liquid crystal display (LCD)

### Description

The TSL1014 device is composed of 14 + 1 channel buffers which are used to buffer the reference voltage for gamma correction in thin film transistor (TFT) liquid crystal displays (LCD).

One “COM” amplifier is able to deliver high output current value, up to  $\pm 100$  mA. Amplifiers A and B feature positive single supply inputs for common mode voltage behavior. The amplifiers C to N inclusive, and the COM amplifier, feature negative single supply inputs and are dedicated to the highest and lowest gamma voltages.

The TSL1014 device is fully characterized and guaranteed over a wide industrial temperature range (-40 to +85 °C).

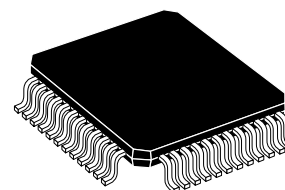

7 x 7 mm TQFP48

### Pin connections (top view)

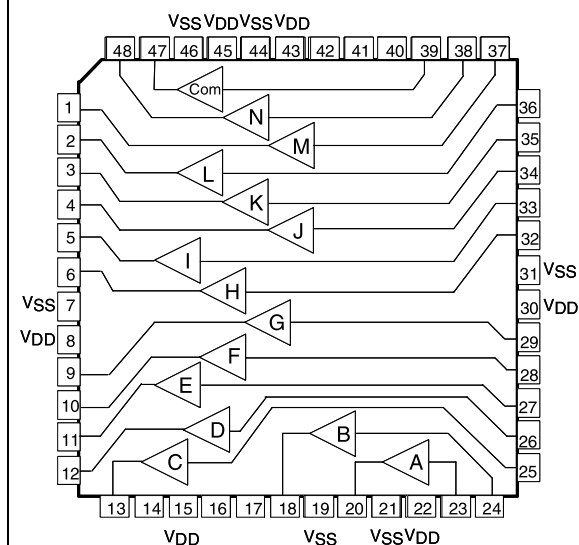

# 1 Absolute maximum ratings and operating conditions

**Table 1. Absolute maximum ratings**

Symbol	Parameter	Value	Unit
$V_{CC}$	Supply voltage ( $V_{DD} - V_{SS}$ )	18	V
$V_{IN}$	Input voltage	$V_{SS} - 0.5\text{ V to } V_{DD} + 0.5\text{ V}$	V
$I_{OUT}$	Output current (A to N buffers) Output current (COM buffer)	30 100	mA
$I_{SC}$	Short-circuit current (A to N buffers) Short-circuit current (COM buffer)	$\pm 120$ $\pm 300$	mA
$P_D$	Power dissipation <sup>(1)</sup> for TQFP48	1470	mW
$R_{THJA}$	Thermal resistance junction-to-ambient for TQFP48	85	°C/W
$T_{LEAD}$	Lead temperature (soldering 10 seconds)	260	°C
$T_{STG}$	Storage temperature	-65 to +150	°C
$T_J$	Junction temperature	150	°C
ESD	Human body model (HBM) <sup>(2)</sup>	2000	V
	Machine model (MM) <sup>(3)</sup>	200	
	Charged device model (CDM) <sup>(4)</sup>	1500	

- $P_D$  is calculated with  $T_{amb} = 25\text{ °C}$ ,  $T_J = 150\text{ °C}$  and  $R_{THJA} = 85\text{ °C/W}$  for the TQFP48 package.
- Human body model: a 100 pF capacitor is charged to the specified voltage, then discharged through a 1.5 kW resistor between two pins of the device. This is done for all couples of connected pin combinations while the other pins are floating.
- Machine model: a 200 pF capacitor is charged to the specified voltage, then discharged directly between two pins of the device with no external series resistor (internal resistor < 5 W). This is done for all couples of connected pin combinations while the other pins are floating.
- Charged device model: all pins and package are charged together to the specified voltage and then discharged directly to ground through only one pin.

**Table 2. Operating conditions**

Symbol	Parameter	Value	Unit
$V_{CC}$	Supply voltage ( $V_{DD} - V_{SS}$ )	5.5 to 16.8	V
$T_{amb}$	Ambient temperature	-40 to +85	°C
$V_{IN}$	Input voltage (buffers A and B)	$V_{SS} + 1.5\text{ V to } V_{DD}$	V
	Input voltage (buffers C to N + COM)	$V_{SS}\text{ to } V_{DD} - 1.5\text{ V}$	

## 2 Typical application schematics

Figure 1. Typical application schematic for the TSL1014 device

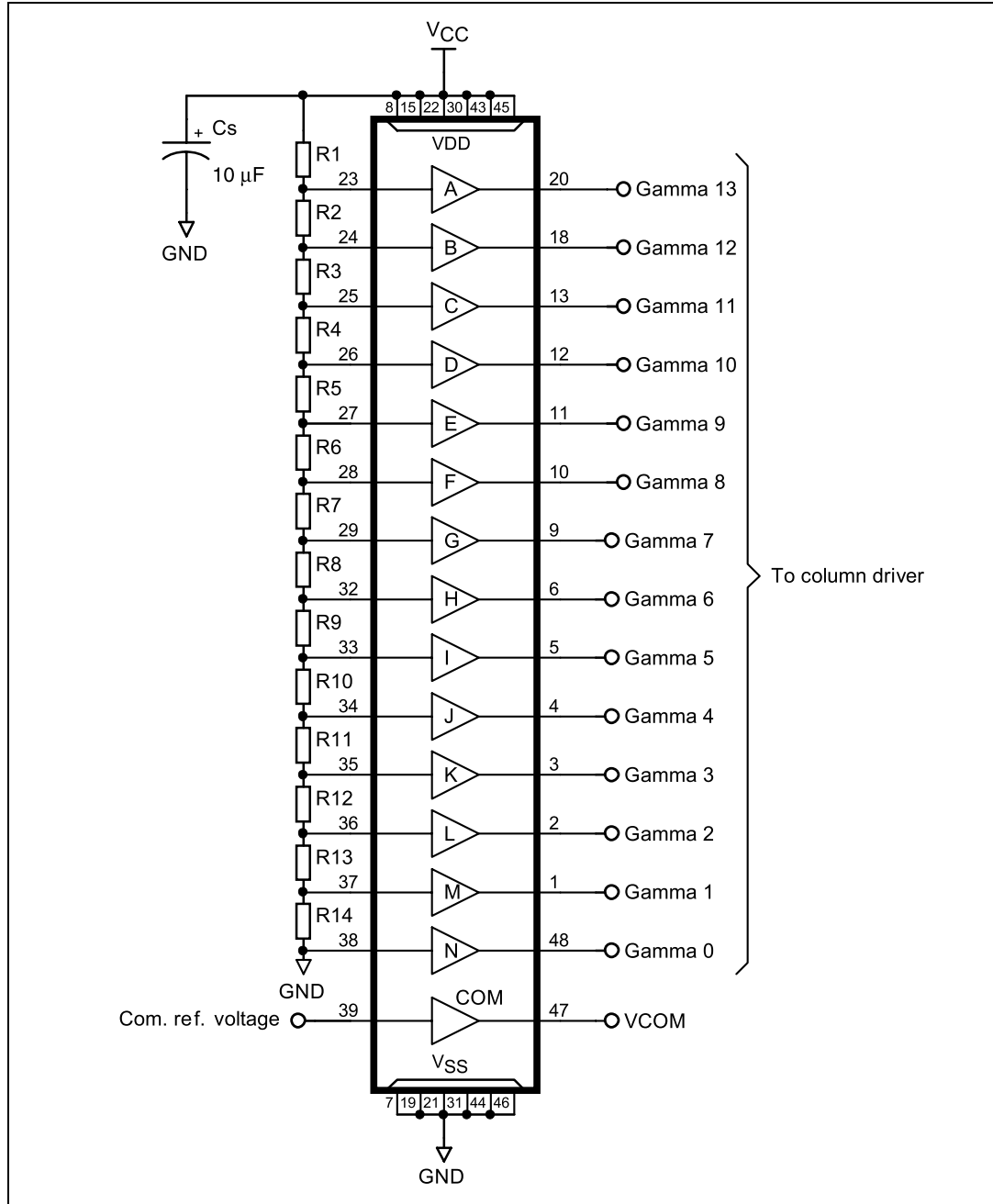

Note that:

- Amplifiers **A** and **B** have their input voltage in the range  $V_{SS} + 1.5\text{ V}$  to  $V_{DD}$ . This is why they must be used for high level gamma correction voltages.
- Amplifiers **C** to **N** have their input voltage in the range  $V_{SS}$  to  $V_{DD} - 1.5\text{ V}$ . This is why they must be used for medium-to-low level gamma correction voltages.
- Amplifier **COM** has its input voltage range from  $V_{SS}$  to  $V_{DD} - 1.5\text{ V}$ .

### 3 Electrical characteristics

**Table 3. Electrical characteristics for TSL1014IF/TSL1014IFT**  
 $T_{amb} = 25\text{ °C}$ ,  $V_{DD} = +5\text{ V}$ ,  $V_{SS} = -5\text{ V}$ ,  $R_L = 10\text{ k}\Omega$ ,  $C_L = 10\text{ pF}$   
 (unless otherwise specified)

Symbol	Parameter	Test conditions	Min.	Typ.	Max.	Unit
$V_{IO}$	Input offset voltage	$V_{ICM} = 0\text{ V}$			12	mV
$\Delta V_{IO}$	Input offset voltage drift	$T_{Min} < T_{amb} < T_{Max}$		5		$\mu\text{V}/\text{°C}$
$I_{IB}$	Input bias current	$V_{ICM} = 0\text{ V}$ , buffers A and B $V_{ICM} = 0\text{ V}$ , buffers C to N and COM			140 70	nA
$R_{IN}$	Input impedance			1		G $\Omega$
$C_{IN}$	Input capacitance			1.35		pF
$V_{OL}$	Output voltage low	$I_{OUT} = -5\text{ mA}$ Buffers C to L Buffers M, N and COM		-4.85 -4.92	-4.80 -4.85	V
$V_{OH}$	Output voltage high	$I_{OUT} = 5\text{ mA}$ for positive single supply buffers (A and B)	4.82	4.87		V
$I_{OUT}$	Output current	(A to N buffers)		$\pm 30$		mA
		COM buffer		$\pm 100$		
PSRR	Power supply rejection ratio	$V_{CC} = 6.5\text{ to }15.5\text{ V}$	80	100		dB
$I_{CC}$	Supply current	No load		6	8.4	mA
SR	Slew rate (rising and falling edge)	$-4\text{ V} < V_{OUT} < +4\text{ V}$ 20% to 80%		1		V/ $\mu\text{s}$
$t_s$	Settling time	Settling to 0.1%, $V_{OUT} = 2\text{ V}$ step		5		$\mu\text{s}$
BW	Bandwidth at -3 dB	$R_L = 10\text{ k}\Omega$ , $C_L = 10\text{ pF}$		2		MHz
$G_m$	Phase margin	$R_L = 10\text{ k}\Omega$ , $C_L = 10\text{ pF}$		60		Degrees
$C_s$	Channel separation	$f = 1\text{ MHz}$		75		dB

*Note: Limits are 100% production tested at 25 °C. Behavior at the temperature range limits is guaranteed through correlation and by design.*

**Table 4. Electrical characteristics for TSL1014IYFT (automotive grade)**  
 $T_{amb} = 25\text{ °C}$ ,  $V_{DD} = +5\text{ V}$ ,  $V_{SS} = -5\text{ V}$ ,  $R_L = 10\text{ k}\Omega$ ,  $C_L = 10\text{ pF}$   
 (unless otherwise specified)

Symbol	Parameter	Test conditions	Min.	Typ.	Max.	Unit
$V_{IO}$	Input offset voltage	$V_{ICM} = 0\text{ V}$ $T_{Min} < T_{amb} < T_{Max}$			12	mV
$\Delta V_{IO}$	Input offset voltage drift	$T_{Min} < T_{amb} < T_{Max}$		5		$\mu\text{V}/\text{°C}$
$I_{IB}$	Input bias current	$V_{ICM} = 0\text{ V}$ , buffers A and B $T_{Min} < T_{amb} < T_{Max}$  $V_{ICM} = 0\text{ V}$ , buffers C to N and COM $T_{Min} < T_{amb} < T_{Max}$			140 280  70 140	nA
$R_{IN}$	Input impedance			1		$\text{G}\Omega$
$C_{IN}$	Input capacitance			1.35		pF
$V_{OL}$	Output voltage low	$I_{OUT} = -5\text{ mA}$ Buffers C to L $T_{Min} < T_{amb} < T_{Max}$  Buffers M, N and COM $T_{Min} < T_{amb} < T_{Max}$		-4.85  -4.92	-4.80 -4.76  -4.85 -4.83	V
$V_{OH}$	Output voltage high	$I_{OUT} = 5\text{ mA}$ for positive single-supply buffers (A and B) $T_{Min} < T_{amb} < T_{Max}$	4.82 4.80	4.87		V
$I_{OUT}$	Output current	(A to N buffers) COM buffer		$\pm 30$ $\pm 100$		mA
PSRR	Power supply rejection ratio	$V_{CC} = 6.5\text{ to }15.5\text{ V}$ $T_{Min} < T_{amb} < T_{Max}$	80	100		dB
$I_{CC}$	Supply current	No load $T_{Min} < T_{amb} < T_{Max}$		6	8.4 9	mA
SR	Slew rate (rising and falling edge)	$-4\text{ V} < V_{OUT} < +4\text{ V}$ 20% to 80%		1		$\text{V}/\mu\text{s}$
$t_s$	Settling time	Settling to 0.1%, $V_{OUT} = 2\text{ V}$ step		5		$\mu\text{s}$
BW	Bandwidth at -3 dB	$R_L = 10\text{ k}\Omega$ , $C_L = 10\text{ pF}$		2		MHz
$G_m$	Phase margin	$R_L = 10\text{ k}\Omega$ , $C_L = 10\text{ pF}$		60		Degrees
$C_s$	Channel separation	$f = 1\text{ MHz}$		75		dB

*Note: Limits are 100% production tested at 25 °C. Behavior at the temperature range limits is guaranteed through correlation and by design.*

**Figure 2. Supply current vs. supply voltage for various temperatures**

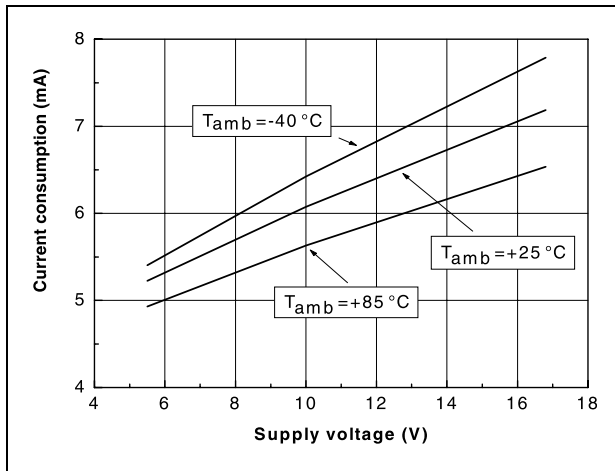

**Figure 3. Output offset voltage (eq.  $V_{IO}$ ) vs. temperature**

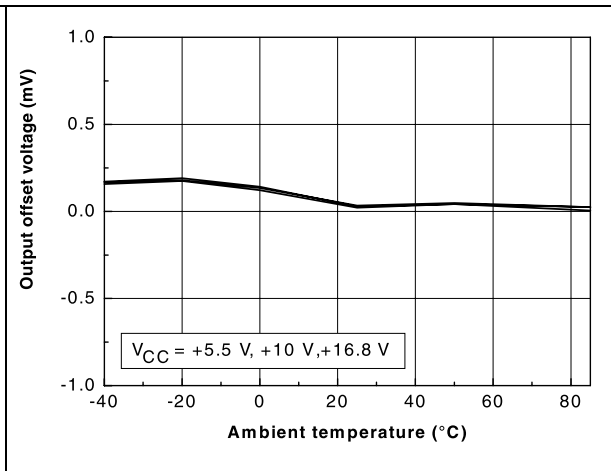

**Figure 4. Input current ( $I_{IB}$ ) vs. temperature, buffers A and B**

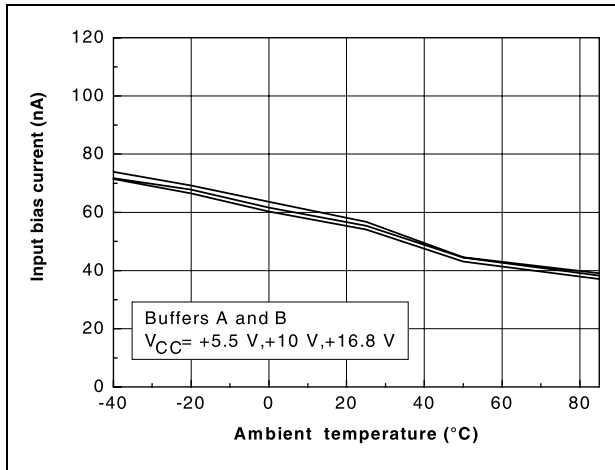

**Figure 5. Input current ( $I_{IB}$ ) vs. temperature, buffers C to COM**

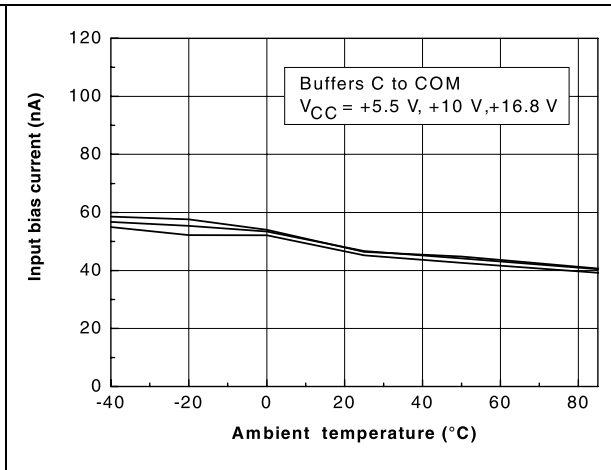

**Figure 6. Output current capability vs. temperature, buffers A and B**

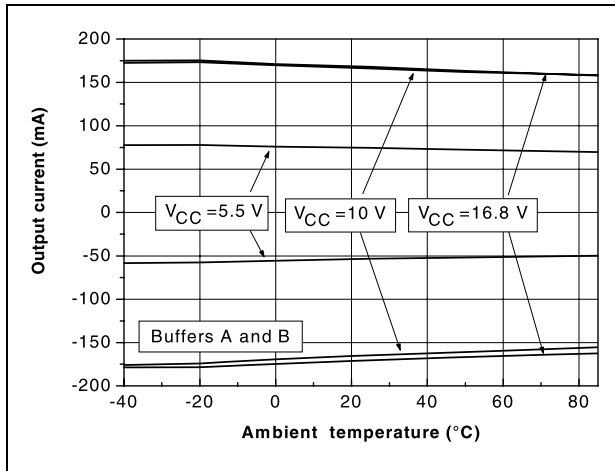

**Figure 7. Output current capability vs. temperature, buffers C to N**

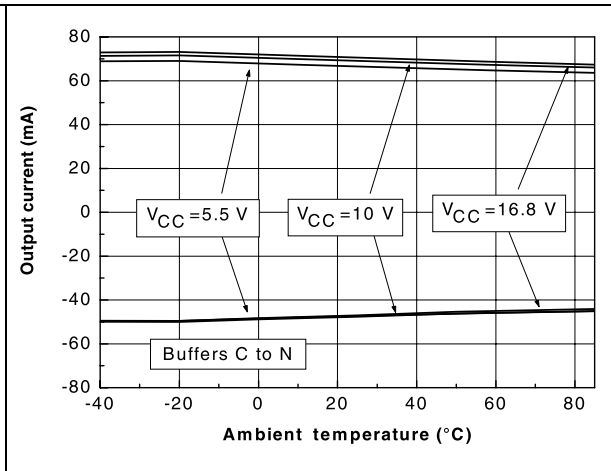

**Figure 8. Output current capability vs. temperature, buffer COM**

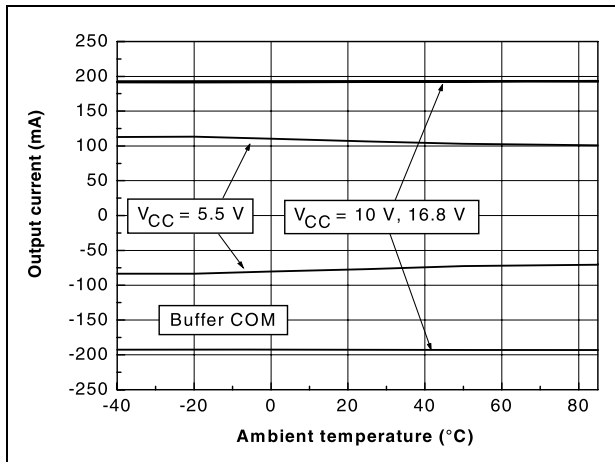

**Figure 9. High level voltage drop vs. temperature**

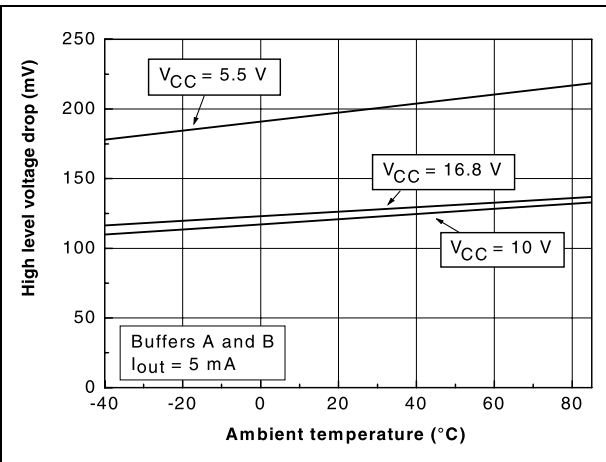

**Figure 10. Low level voltage drop vs. temperature, buffers C to L**

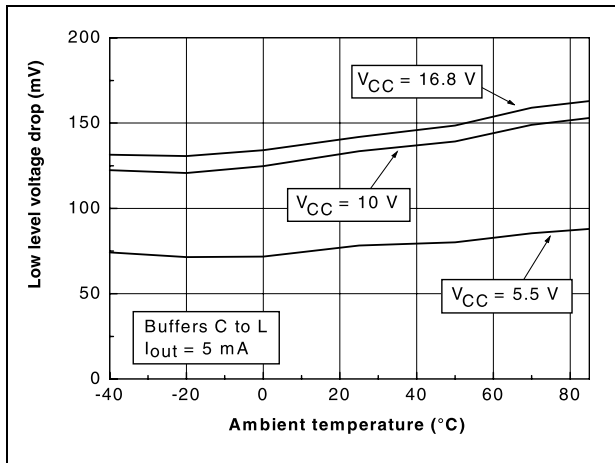

**Figure 11. Low level voltage drop vs. temperature, buffers M, N, and COM**

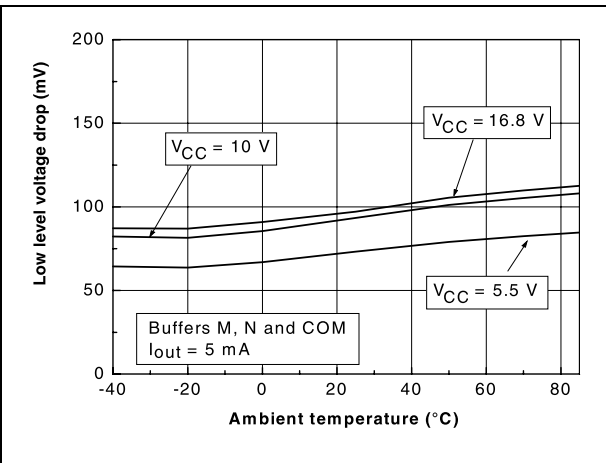

**Figure 12. Voltage output high (VOH) vs. output current - buffers A and B, VCC = 5 V**

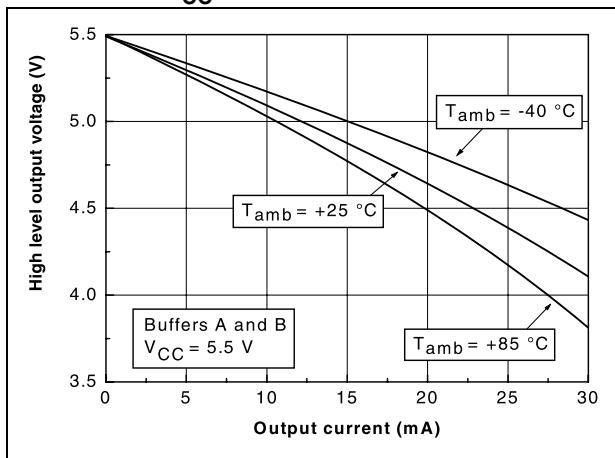

**Figure 13. Voltage output high (VOH) vs. output current - buffers A and B, VCC = 10 V**

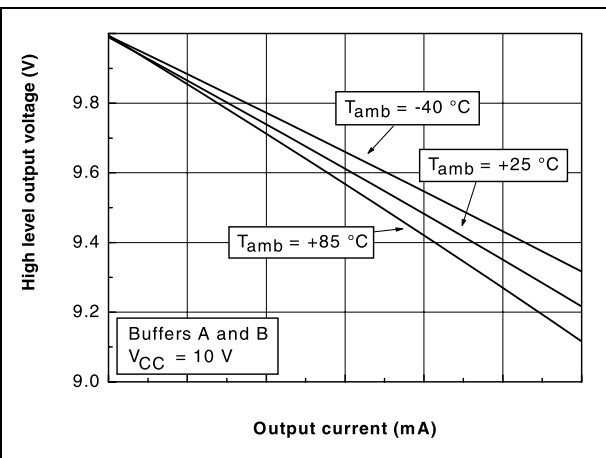

Figure 14. Voltage output high ( $V_{OH}$ ) vs. output current - buffers A and B,  $V_{CC} = 16.8$  V

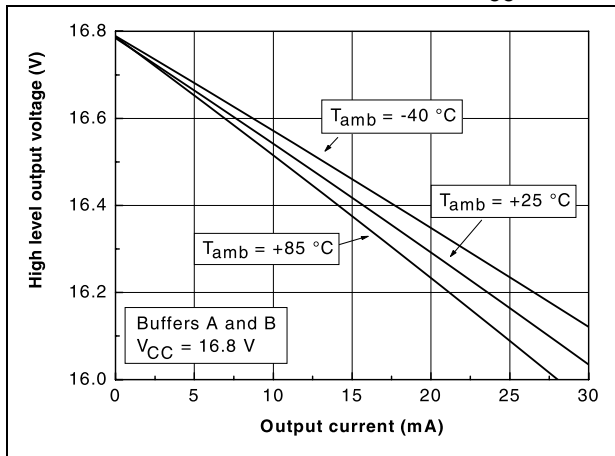

Figure 15. Voltage output low ( $V_{OL}$ ) vs. output current - buffers C to L,  $V_{CC} = 5.5$  V

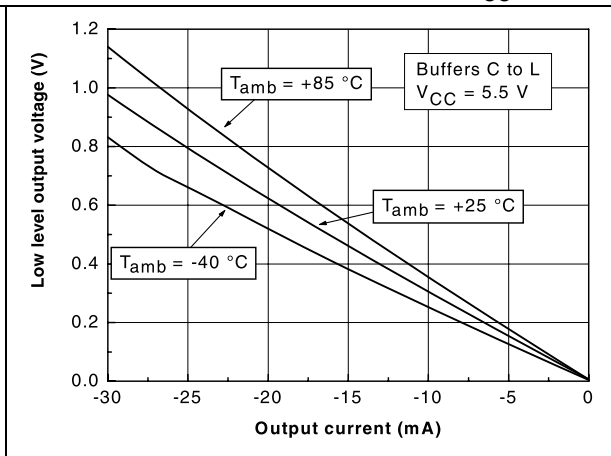

Figure 16. Voltage output low ( $V_{OL}$ ) vs. output current - buffers C to L,  $V_{CC} = 10$  V

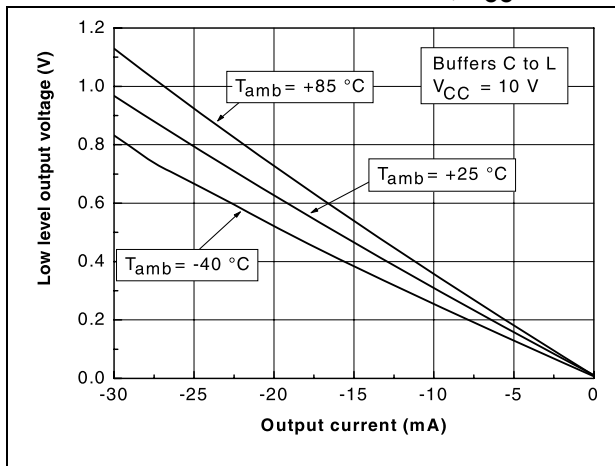

Figure 17. Voltage output low ( $V_{OL}$ ) vs. output current - buffers C to L,  $V_{CC} = 16.8$  V

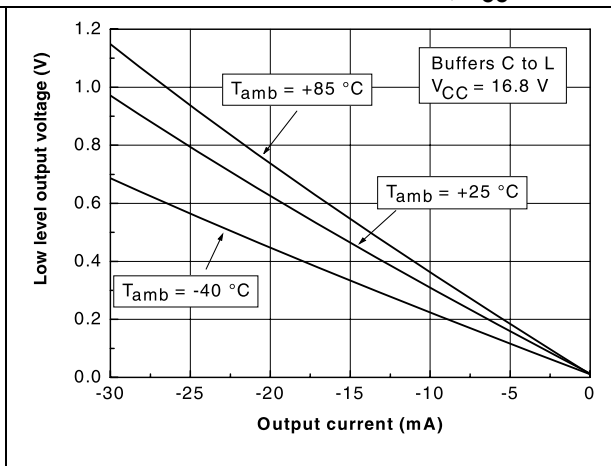

Figure 18. Voltage output low ( $V_{OL}$ ) vs. output current - buffers M, N and COM,  $V_{CC} = 5.5$  V

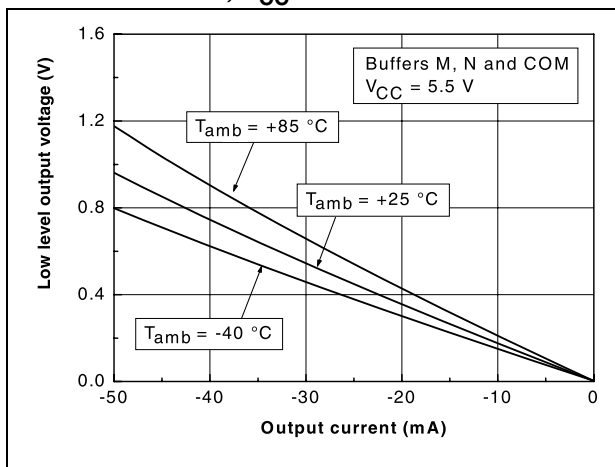
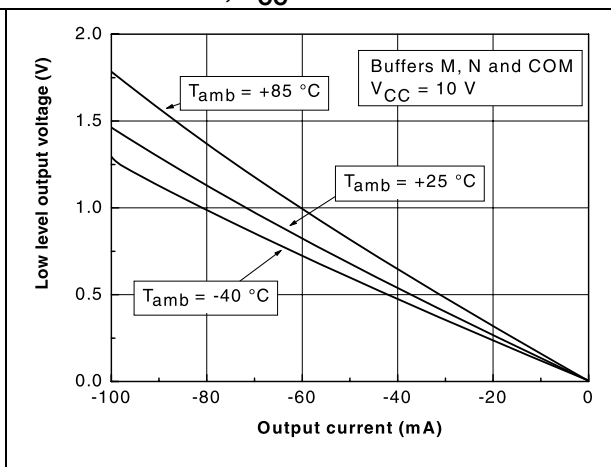
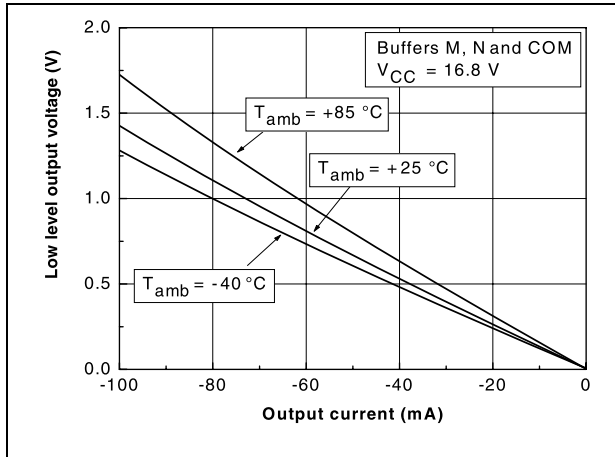

Figure 19. Voltage output low ( $V_{OL}$ ) vs. output current - buffers M, N and COM,  $V_{CC} = 10$  V

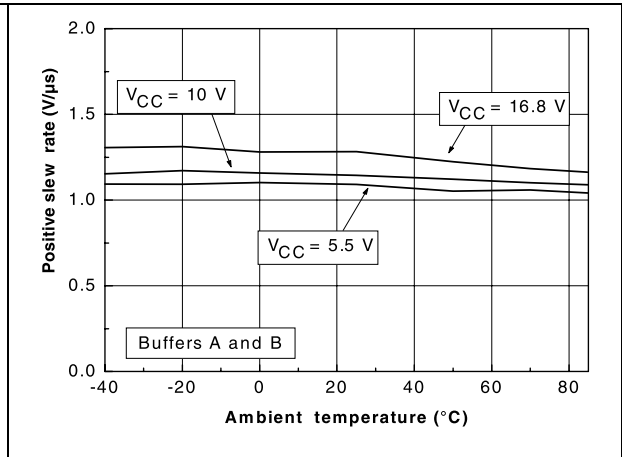



**Figure 20. Voltage output low ( $V_{OL}$ ) vs. output current - buffers M, N and COM,  $V_{CC} = 16.8\text{ V}$**



**Figure 21. Positive slew rate vs. temperature,  $V_{CC} = 5.5\text{ V}$**



**Figure 22. Positive slew rate vs. temperature,  $V_{CC} = 10\text{ V}$**

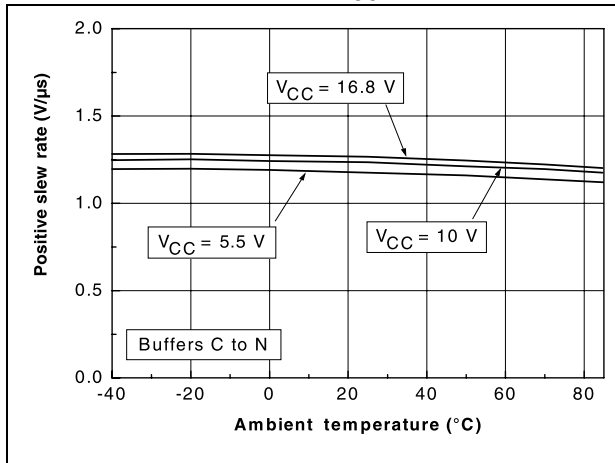

**Figure 23. Positive slew rate vs. temperature,  $V_{CC} = 16.8\text{ V}$**

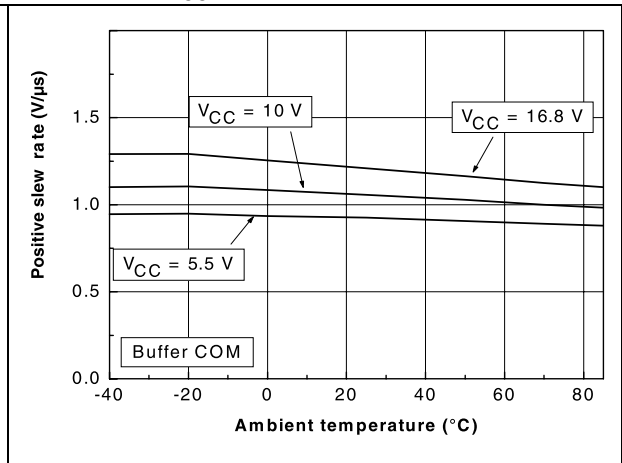

**Figure 24. Negative slew rate vs. temperature, buffers A and B**

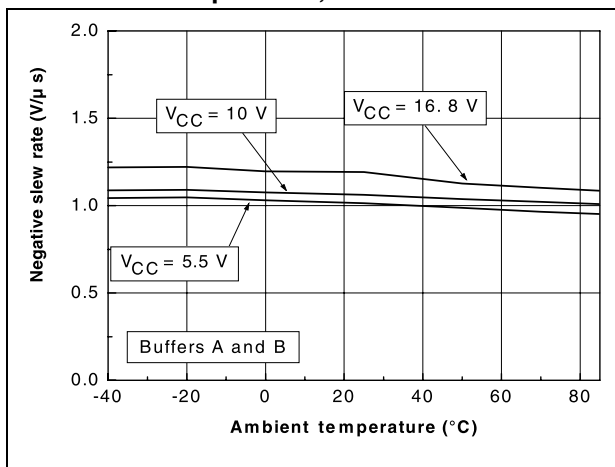

**Figure 25. Negative slew rate vs. temperature, buffers C to N**

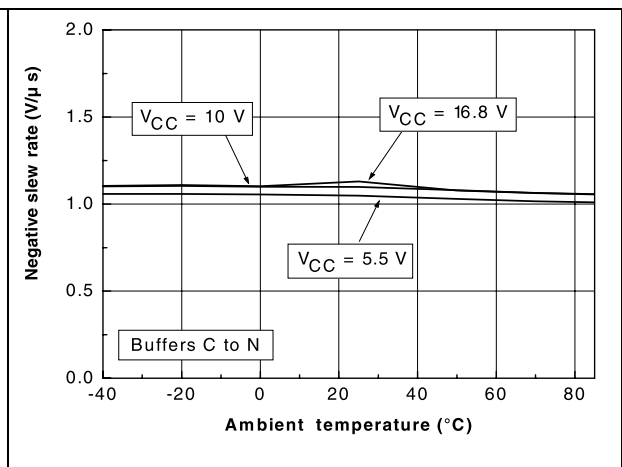

Figure 26. Negative slew rate vs. temperature, buffer COM

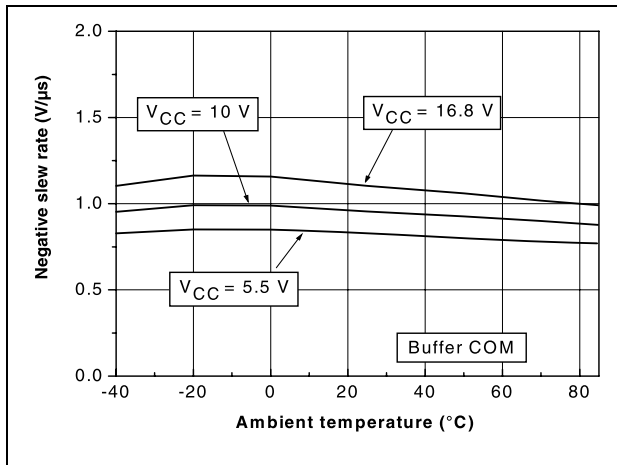

Figure 27. Large signal response - buffers A and B - positive step

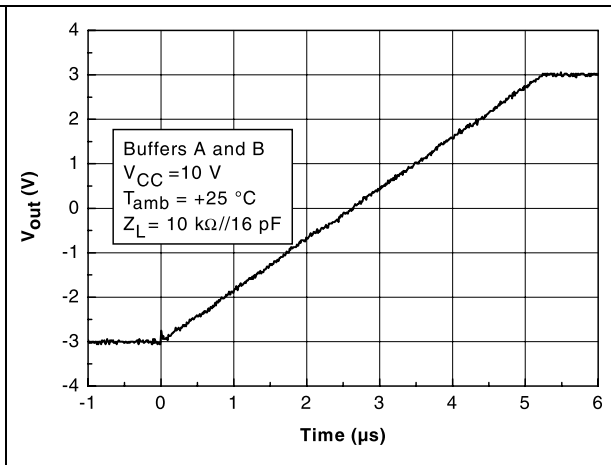

Figure 28. Large signal response - buffers A and B - negative step

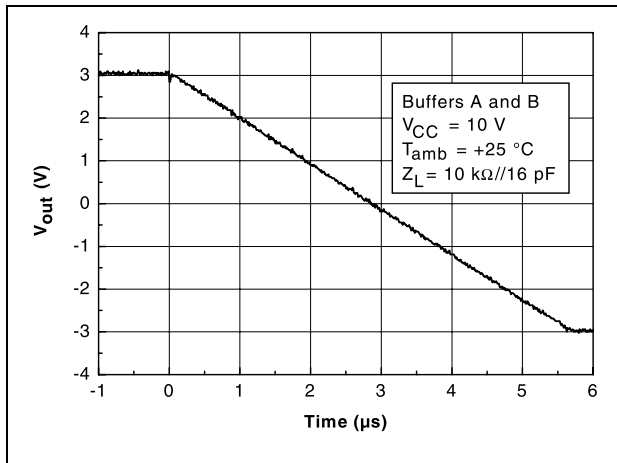

Figure 29. Large signal response - buffers C to N - positive step

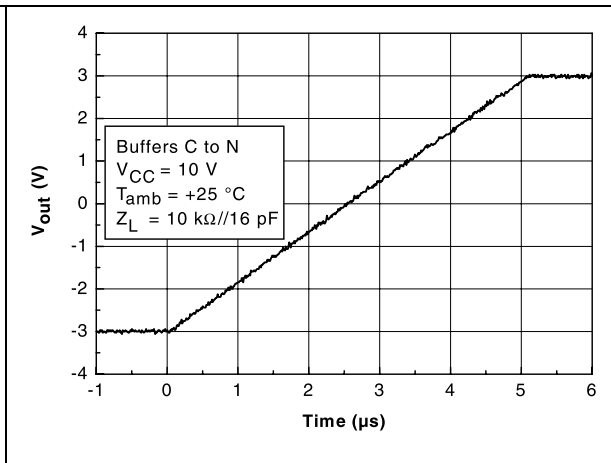

Figure 30. Large signal response - buffers C to N - negative step

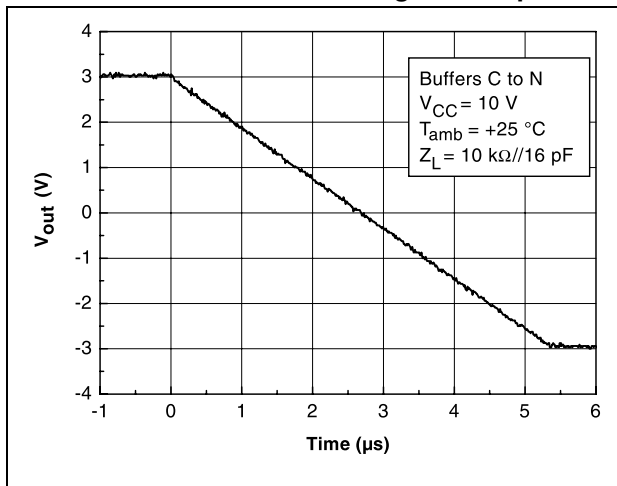
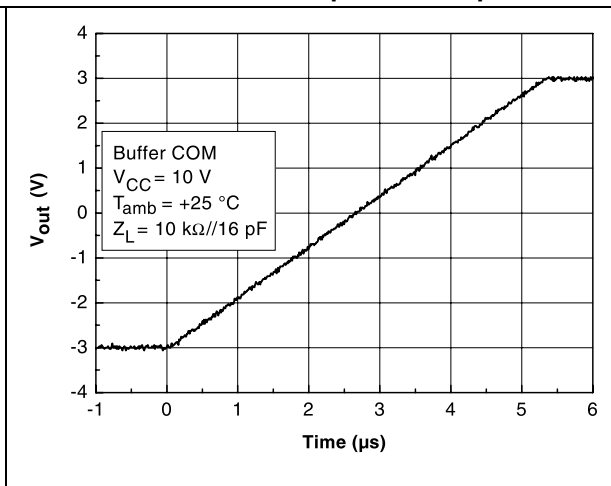
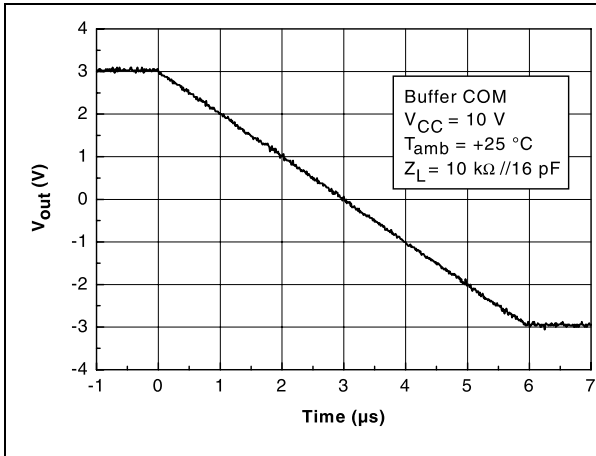

Figure 31. Large signal response - buffer COM - positive step



**Figure 32. Large signal response - buffer COM - negative step**



**Figure 33. Small signal response - buffers A and B**

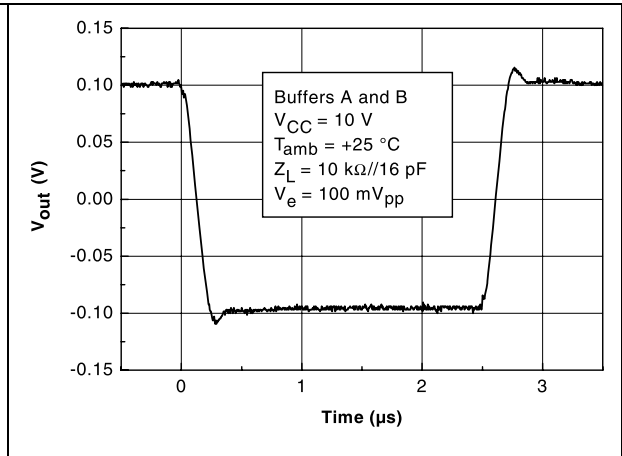

**Figure 34. Small signal response - buffers C to N**

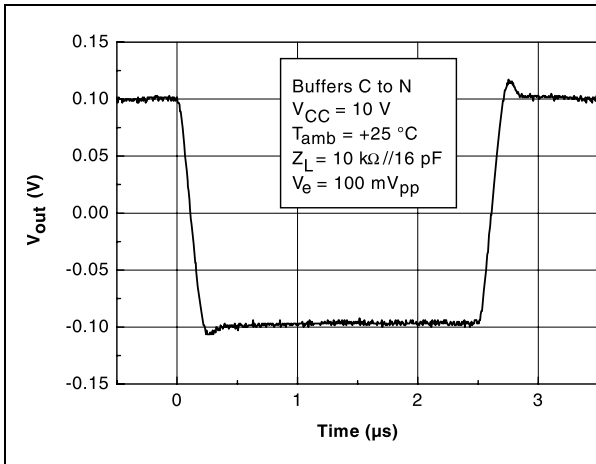

**Figure 35. Small signal response - buffer COM**

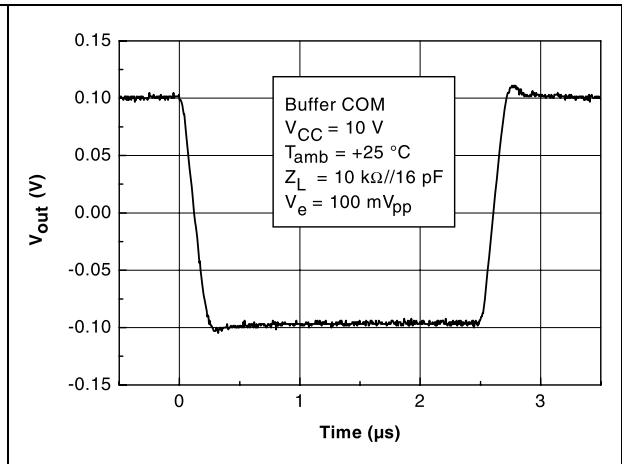

**Figure 36. Output voltage response to current transient - buffers A and B,  $\Delta I = 0$  to 30 mA**

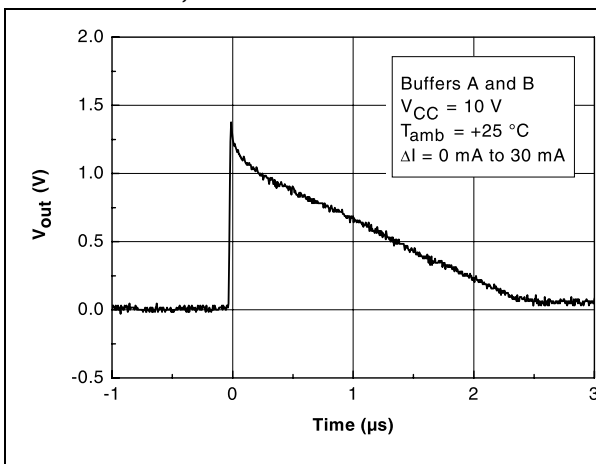

**Figure 37. Output voltage response to current transient - buffers A and B,  $\Delta I = 30$  to 0 mA**

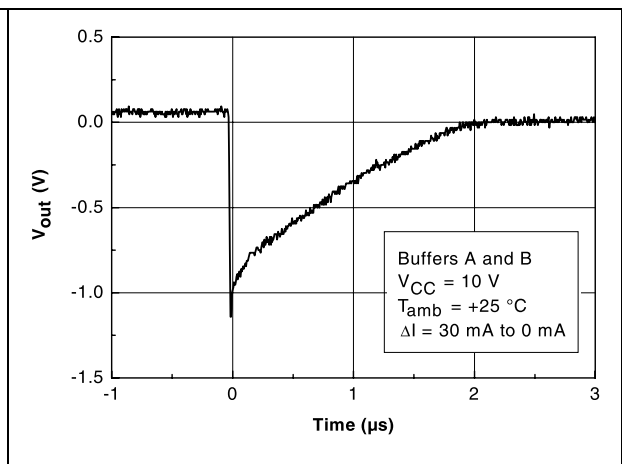

**Figure 38. Output voltage response to current transient - buffers C to N,  $\Delta I = 0$  to 30 mA**

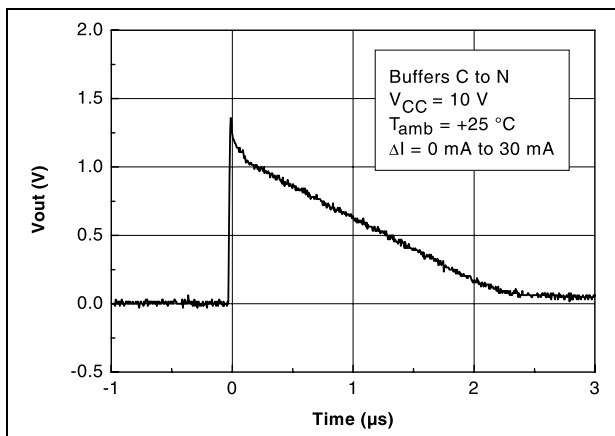

**Figure 39. Output voltage response to current transient - buffers C to N,  $\Delta I = 30$  to 0 mA**

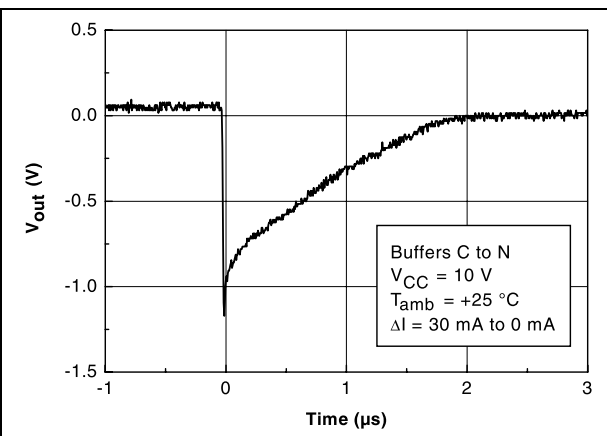

**Figure 40. Output voltage response to current transient - buffer COM,  $\Delta I = 0$  to 100 mA**

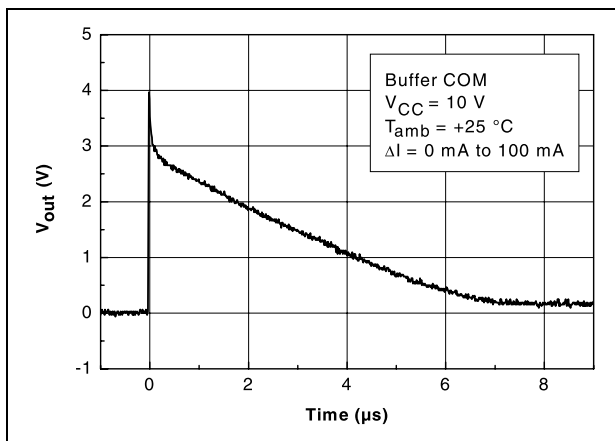

**Figure 41. Output voltage response to current transient - buffer COM,  $\Delta I = 100$  to 0 mA**

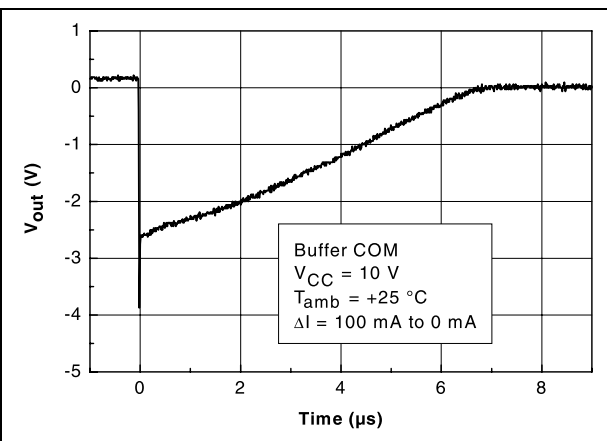

**Figure 42. Output voltage response to current transient - buffer COM,  $\Delta I = 100$  to -100 mA**

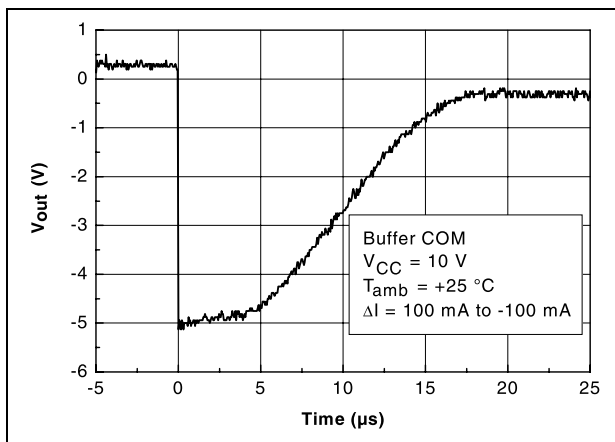

**Figure 43. Output voltage response to current transient - buffer COM,  $\Delta I = -100$  to +100 mA**

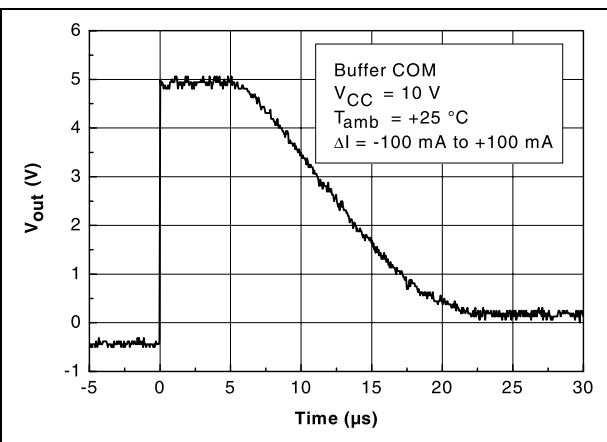

## 4 Package information

In order to meet environmental requirements, ST offers these devices in different grades of ECOPACK<sup>®</sup> packages, depending on their level of environmental compliance. ECOPACK specifications, grade definitions and product status are available at: [www.st.com](http://www.st.com). ECOPACK is an ST trademark.

Figure 44. TQFP48 package outline

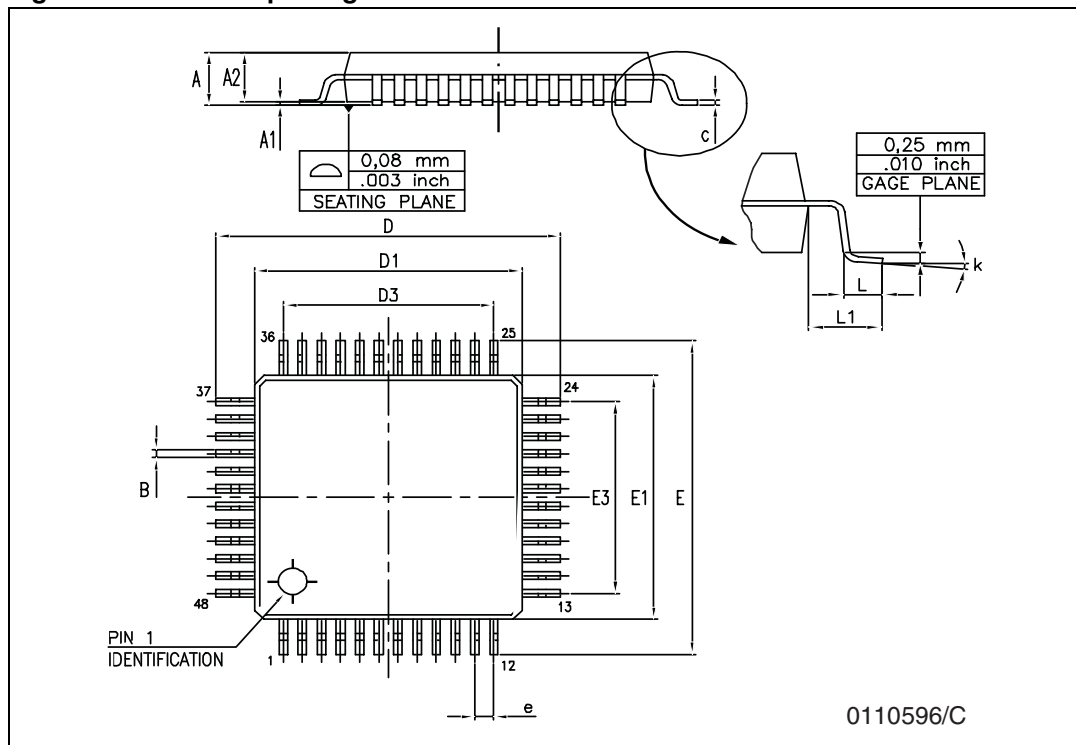

Table 5. TQFP48 package mechanical data

Symbol	Dimensions					
	Millimeters			Inches		
	Min.	Typ.	Max.	Min.	Typ.	Max.
A			1.6			0.063
A1	0.05		0.15	0.002		0.006
A2	1.35	1.40	1.45	0.053	0.055	0.057
B	0.17	0.22	0.27	0.007	0.009	0.011
C	0.09		0.20	0.0035		0.0079
D		9.00			0.354	
D1		7.00			0.276	
D3		5.50			0.216	
e		0.50			0.020	
E		9.00			0.354	
E1		7.00			0.276	
E3		5.50			0.216	
L	0.45	0.60	0.75	0.018	0.024	0.030
L1		1.00			0.039	
K	0°	3.5°	7°	0°	3.5°	7°

## 5 Ordering information

**Table 6. Order codes**

Order code	Temperature range	Package	Packing	Marking
TSL1014IF	-40 °C to +85 °C	TQFP48	Tray	SL1014I
TSL1014IFT			Tape and reel	
TSL1014IYFT <sup>(1)</sup>			Tape and reel	SL1014Y

1. Qualified and characterized according to AEC Q100 and Q003 or equivalent, advanced screening according to AEC Q001 and Q 002 or equivalent.

## 6 Revision history

**Table 7. Document revision history**

Date	Revision	Changes
01-Jul-2005	1	Initial release - Product in full production.
01-Sep-2005	2	Lead temperature corrected in <a href="#">Table 1 on page 2</a> . Electrical characteristics graphs re-ordered from <a href="#">Figure 2 on page 6</a> to <a href="#">Figure 43 on page 12</a> .
07-Mar-2007	3	Notes added on ESD in <a href="#">Table 1 on page 2</a> . Maximum operating supply voltage increased in <a href="#">Table 2 on page 2</a> . Input voltage parameters added in <a href="#">Table 2 on page 2</a> . $V_{OL}$ limits changed for Buffers C to L in <a href="#">Table 4 on page 5</a> .
09-Jun-2008	4	Electrical characteristics table added for automotive parts. Order codes added for automotive parts.
19-Aug-2008	5	Modified $I_{CC}$ typical and maximum values for standard parts in <a href="#">Table 3</a> . Updated all curves ( <a href="#">Figure 2</a> to <a href="#">Figure 43</a> ). Added ESD charged device model value in <a href="#">Figure 1</a> .
11-May-2009	6	Modified footnote under <a href="#">Table 6: Order codes</a> .
14-Nov-2012	7	Removed TSL1014IYF device from <a href="#">Table 4</a> and <a href="#">Table 6</a> . Renamed titles of <a href="#">Figure 4</a> to <a href="#">Figure 8</a> , <a href="#">Figure 10</a> to <a href="#">Figure 32</a> , and <a href="#">Figure 36</a> to <a href="#">Figure 43</a> (added conditions). Reformatted <a href="#">Section 4</a> (added <a href="#">Figure 44</a> ). Minor corrections throughout document.



**Please Read Carefully:**

Information in this document is provided solely in connection with ST products. STMicroelectronics NV and its subsidiaries ("ST") reserve the right to make changes, corrections, modifications or improvements, to this document, and the products and services described herein at any time, without notice.

All ST products are sold pursuant to ST's terms and conditions of sale.

Purchasers are solely responsible for the choice, selection and use of the ST products and services described herein, and ST assumes no liability whatsoever relating to the choice, selection or use of the ST products and services described herein.

No license, express or implied, by estoppel or otherwise, to any intellectual property rights is granted under this document. If any part of this document refers to any third party products or services it shall not be deemed a license grant by ST for the use of such third party products or services, or any intellectual property contained therein or considered as a warranty covering the use in any manner whatsoever of such third party products or services or any intellectual property contained therein.

**UNLESS OTHERWISE SET FORTH IN ST'S TERMS AND CONDITIONS OF SALE ST DISCLAIMS ANY EXPRESS OR IMPLIED WARRANTY WITH RESPECT TO THE USE AND/OR SALE OF ST PRODUCTS INCLUDING WITHOUT LIMITATION IMPLIED WARRANTIES OF MERCHANTABILITY, FITNESS FOR A PARTICULAR PURPOSE (AND THEIR EQUIVALENTS UNDER THE LAWS OF ANY JURISDICTION), OR INFRINGEMENT OF ANY PATENT, COPYRIGHT OR OTHER INTELLECTUAL PROPERTY RIGHT.**

**UNLESS EXPRESSLY APPROVED IN WRITING BY TWO AUTHORIZED ST REPRESENTATIVES, ST PRODUCTS ARE NOT RECOMMENDED, AUTHORIZED OR WARRANTED FOR USE IN MILITARY, AIR CRAFT, SPACE, LIFE SAVING, OR LIFE SUSTAINING APPLICATIONS, NOR IN PRODUCTS OR SYSTEMS WHERE FAILURE OR MALFUNCTION MAY RESULT IN PERSONAL INJURY, DEATH, OR SEVERE PROPERTY OR ENVIRONMENTAL DAMAGE. ST PRODUCTS WHICH ARE NOT SPECIFIED AS "AUTOMOTIVE GRADE" MAY ONLY BE USED IN AUTOMOTIVE APPLICATIONS AT USER'S OWN RISK.**

Resale of ST products with provisions different from the statements and/or technical features set forth in this document shall immediately void any warranty granted by ST for the ST product or service described herein and shall not create or extend in any manner whatsoever, any liability of ST.

ST and the ST logo are trademarks or registered trademarks of ST in various countries.

Information in this document supersedes and replaces all information previously supplied.

The ST logo is a registered trademark of STMicroelectronics. All other names are the property of their respective owners.

© 2012 STMicroelectronics - All rights reserved

STMicroelectronics group of companies

Australia - Belgium - Brazil - Canada - China - Czech Republic - Finland - France - Germany - Hong Kong - India - Israel - Italy - Japan - Malaysia - Malta - Morocco - Philippines - Singapore - Spain - Sweden - Switzerland - United Kingdom - United States of America

[www.st.com](http://www.st.com)



Компания «Океан Электроники» предлагает заключение долгосрочных отношений при поставках импортных электронных компонентов на взаимовыгодных условиях!

Наши преимущества:

- Поставка оригинальных импортных электронных компонентов напрямую с производств Америки, Европы и Азии, а так же с крупнейших складов мира;
- Широкая линейка поставок активных и пассивных импортных электронных компонентов (более 30 млн. наименований);
- Поставка сложных, дефицитных, либо снятых с производства позиций;
- Оперативные сроки поставки под заказ (от 5 рабочих дней);
- Экспресс доставка в любую точку России;
- Помощь Конструкторского Отдела и консультации квалифицированных инженеров;
- Техническая поддержка проекта, помощь в подборе аналогов, поставка прототипов;
- Поставка электронных компонентов под контролем ВП;
- Система менеджмента качества сертифицирована по Международному стандарту ISO 9001;
- При необходимости вся продукция военного и аэрокосмического назначения проходит испытания и сертификацию в лаборатории (по согласованию с заказчиком);
- Поставка специализированных компонентов военного и аэрокосмического уровня качества (Xilinx, Altera, Analog Devices, Intersil, Interpoint, Microsemi, Actel, Aeroflex, Peregrine, VPT, Syfer, Eurofarad, Texas Instruments, MS Kennedy, Miteq, Cobham, E2V, MA-COM, Hittite, Mini-Circuits, General Dynamics и др.);

Компания «Океан Электроники» является официальным дистрибьютором и эксклюзивным представителем в России одного из крупнейших производителей разъемов военного и аэрокосмического назначения «JONHON», а так же официальным дистрибьютором и эксклюзивным представителем в России производителя высокотехнологичных и надежных решений для передачи СВЧ сигналов «FORSTAR».



## JONHON

«JONHON» (основан в 1970 г.)

Разъемы специального, военного и аэрокосмического назначения:

(Применяются в военной, авиационной, аэрокосмической, морской, железнодорожной, горно- и нефтедобывающей отраслях промышленности)

«FORSTAR» (основан в 1998 г.)

ВЧ соединители, коаксиальные кабели,  
кабельные сборки и микроволновые компоненты:

(Применяются в телекоммуникациях гражданского и специального назначения, в средствах связи, РЛС, а так же военной, авиационной и аэрокосмической отраслях промышленности).



Телефон: 8 (812) 309-75-97 (многоканальный)

Факс: 8 (812) 320-03-32

Электронная почта: [ocean@oceanchips.ru](mailto:ocean@oceanchips.ru)

Web: <http://oceanchips.ru/>

Адрес: 198099, г. Санкт-Петербург, ул. Калинина, д. 2, корп. 4, лит. А