

CERAFIL® (Filters/Traps/Discriminators) for Audio/Visual Equipment



muRata

*Innovator
in Electronics*

Murata
Manufacturing Co., Ltd.

EU RoHS Compliant

- All the products in this catalog comply with EU RoHS.
- EU RoHS is "the European Directive 2011/65/EU on the Restriction of the Use of Certain Hazardous Substances in Electrical and Electronic Equipment."
- For more details, please refer to our website 'Murata's Approach for EU RoHS' (<http://www.murata.com/info/rohs.html>).

CONTENTS

CERAFIL® and "CERAFIL" in this catalog are the trademarks of Murata Manufacturing Co., Ltd.

| | |
|--|----|
| Part Numbering | 2 |
| 1. CERAFIL® | |
| 1-1 CERAFIL® 10.7MHz | |
| 1 Small Chip Type SFECF Series | 5 |
| 2 Chip Type SFECV/SFECK Series | 11 |
| 3 Standard Lead Type SFELF Series | 14 |
| 4 Low Loss Type SFELF Series | 17 |
| 5 Low Spurious Response Type SFELF Series | 20 |
| 6 Wide Bandwidth Type SFELF Series | 23 |
| 7 Narrow Bandwidth Type SFELF Series | 25 |
| 8 For FM-IF Tuners SFELF Series | 27 |
| Related Data on Lead Type | 30 |
| 1-2 CERAFIL® 2.3-6.5MHz | |
| 9 4.5-6.5MHz Chip Type SFSKA Series | 31 |
| 10 2.3-5.7MHz Chip Type SFSKB Series | 34 |
| 1-3 CERAFIL® 455kHz | |
| 11 Chip Type SFPKA Series | 38 |
| 12 Lead Type SFPLA/CFWLA Series | 40 |
| 13 For AM Stereo Wide Bandwidth Type SFPLA/CFWLA/CFULA Series | 42 |
| SF□ Series Temperature Characteristics | 44 |
| 2. Ceramic Trap | |
| 14 Ceramic Trap 4.5-6.5MHz Chip Type TPSKA Series | 45 |
| 3. Ceramic Discriminator | |
| 15 10.7MHz Ultra Thin Chip Type CDSCB Series | 47 |
| Applied IC Reference Table | 52 |
| Notice | 53 |
| Packaging | 69 |
| Part Number Index | 74 |

● Part Numbering

CERAFIL® for FM

(Part Number)



① Product ID

| Product ID | |
|------------|-----------------|
| SF | Ceramic Filters |

② Oscillation/Number of Elements

| Code | Oscillation/Number of Elements |
|------|---|
| E | 2 Elements Thickness Expander mode |
| T | 3 Elements Thickness Expander mode |
| V | 2 Elements Thickness Expander mode (2nd Harmonic) |
| K | 2 Elements Thickness Expander mode (3rd Overtone) |

③ Structure/Size

| Code | Structure/Size |
|------|----------------|
| L□ | Lead Type |
| C□ | Chip Type |

□ is "A" or subsequent code, which indicates the structure/size.

④ Nominal Center Frequency

Expressed by four-digit alphanumerics. The unit is in hertz (Hz).
 Decimal point is expressed by capital letter "M" in case of MHz.

⑤ 3dB Bandwidth

| Code | 3dB Bandwidth |
|------|---------------|
| C | 450kHz min |
| D | 350kHz min |
| E | 330kHz |
| F | 280kHz |
| G | 230kHz |
| H | 180kHz |
| J | 150kHz |
| K | 110kHz |
| L | 80kHz |
| M | 50kHz |
| N | 35kHz |

⑥ Center Frequency/Tolerance

| Code | Center Frequency | Tolerance |
|------|--|-----------|
| A | Center Frequency mentioned by specification | ±30kHz |
| B | -30kHz shifted from center frequency of code "A" | ±30kHz |
| C | +30kHz shifted from center frequency of code "A" | ±30kHz |
| D | -60kHz shifted from center frequency of code "A" | ±30kHz |
| E | +60kHz shifted from center frequency of code "A" | ±30kHz |
| H | Center Frequency mentioned by specification | ±25kHz |
| V | -50kHz shifted from center frequency of code "H" | ±25kHz |
| W | +50kHz shifted from center frequency of code "H" | ±25kHz |
| K | Center Frequency mentioned by specification | ±20kHz |
| Z | Combination of A, B, C, D, E | — |
| M | Combination of A, B, C | — |
| F | Nominal Center Frequency | — |

3dB bandwidth of "F" signifies the frequency difference (both + and -) from reference frequency, which is nominal center frequency.

⑦ Series

| Code | Series |
|------|--|
| A0 | Two-digit alphanumerics express series |

⑧ Packaging

| Code | Packaging |
|------|--|
| -B0 | Bulk |
| -R0 | Embossed Taping ø180mm |
| -R1 | Embossed Taping ø330mm |
| -A0 | 1500pcs. /Radial Taping H ₀ =18mm |
| -A1 | 1000pcs. /Radial Taping H ₀ =18mm |

Radial taping is applied to lead type and embossed taping to chip type.
 With non-standard products, two-digit alphanumerics indicating "Individual Specification" are added between "⑦Series" and "⑧Packaging."

CERAFIL®

(Part Number)

| | | | | | | |
|----|---|----|------|----|----|-----|
| SF | S | KA | 4M50 | CF | 00 | -R1 |
| ① | ② | ③ | ④ | ⑤ | ⑥ | ⑦ |

① Product ID

| Product ID | |
|------------|-----------------|
| SF | Ceramic Filters |

② Oscillation/Numbers of Element

| Code | Oscillation/Numbers of Element |
|------|---------------------------------|
| S | 2 Elements Thickness Shear mode |

③ Structure/Size

| Code | Structure/Size |
|------|----------------|
| K□ | Chip Type |

□ is "A" or subsequent code, which indicates the structure/size.

④ Nominal Center Frequency

Expressed by four-digit alphanumerics. The unit is in hertz (Hz).
 Decimal point is expressed by capital letter "M" in case of MHz.

⑤ Product Specification Code (1)

| Code | Product Specification Code (1) |
|------|--------------------------------|
| BF | Tight Bandwidth Type |
| CF | Standard Bandwidth Type |
| DF | Broad Bandwidth Type |
| EF | Ultra-broad Bandwidth Type |

⑥ Product Specification Code (2)

| Code | Product Specification Code (2) |
|------|--------------------------------|
| 00 | Standard Type |

⑦ Packaging

| Code | Packaging |
|------|-------------------------------------|
| -B0 | Bulk |
| -R1 | Embossed Taping $\phi=330\text{mm}$ |

With non-standard products, two-digit alphanumerics indicating "Individual Specification" is added between "⑥ Product Specification Code (2)" and "⑦ Packaging."

CERAFIL® for AM

(Part Number)

| | | | | | |
|----|---|----|------|-----|-----|
| SF | P | KA | 455K | D4A | -B0 |
| ① | ② | ③ | ④ | ⑤ | ⑥ |

① Product ID

| Product ID | |
|------------|-----------------|
| SF | Ceramic Filters |
| CF | Ceramic Filters |

② Oscillation/Numbers of Element

| Code | Oscillation/Numbers of Element |
|------|--------------------------------|
| P | 4 Elements Area Expansion mode |

③ Structure/Size

| Code | Structure/Size |
|-------|----------------|
| L□ | Lead Type |
| C□/K□ | Chip Type |

□ is "A" or subsequent code, which indicates the structure/size. It varies depending on vibration mode and number of elements.

④ Nominal Center Frequency

Expressed by four-digit alphanumerics. The unit is in hertz (Hz).
 Capital letter "K" following three figures expresses the unit of "kHz."

⑤ Product Specification

| Code | Product Specification |
|------|---|
| D4A | Three-digit alphanumerics indicate product specification of 3dB or 6dB frequency tolerance. |

□□A indicates standard type.

⑥ Packaging

| Code | Packaging |
|------|---|
| -B0 | Bulk |
| -R0 | Embossed Taping ($\phi 180\text{mm}$) |
| -R1 | Embossed Taping ($\phi 330\text{mm}$) |
| -M0 | Magazine Cassette |

Radial taping is applied to lead type and embossed taping to chip type.
 With non-standard products, three-digit alphanumerics indicating "Individual Specification" is added between "⑤ Product Specification" and "⑥ Packaging."

Ceramic Traps

(Part Number)

| | | | | | | |
|----|---|----|------|---|----|-----|
| TP | S | KA | 4M00 | B | 00 | -R0 |
| ① | ② | ③ | ④ | ⑤ | ⑥ | ⑦ |

① Product ID

| Product ID | |
|------------|---------------|
| TP | Ceramic Traps |

② Function

| Code | Function |
|------|--------------|
| S | Single Traps |

③ Structure/Size

| Code | Structure/Size |
|------|----------------|
| K□ | Chip Type |

□ is "A" or subsequent code, which indicates the structure/size.

④ Nominal Center Frequency

Expressed by four-digit alphanumerics. The unit is in hertz (Hz).
 Decimal point is expressed by capital letter "M" in case of MHz.

Discriminators for FM

(Part Number)

| | | | | | | | |
|----|---|----|------|---|---|-----|-----|
| CD | A | LF | 10M7 | G | A | 001 | -B0 |
| ① | ② | ③ | ④ | ⑤ | ⑥ | ⑦ | ⑧ |

① Product ID

| Product ID | |
|------------|----------------|
| CD | Discriminators |

② Oscillation

| Code | Oscillation |
|------|-------------------------|
| A | Thickness Expander mode |
| S | Thickness Shear mode |

③ Structure/Size

| Code | Structure/Size |
|------|----------------|
| L□ | Lead Type |
| C□ | Chip Type |

□ is "A" or subsequent code, which indicates the structure/size.

④ Nominal Center Frequency

Expressed by four-digit alphanumerics. The unit is in hertz (Hz).
 Decimal point is expressed by capital letter "M" in case of MHz.

⑤ Series

| Code | Series |
|------|--|
| G | Two-digit alphanumerics express series |

⑤ Product Specification Code (1)

| Code | Product Specification (1) |
|------|---------------------------|
| B | Broad bandwidth Type |
| C | Low capacitance Type |

⑥ Product Specification Code (2)

| Code | Product Specification (2) |
|------|---------------------------|
| 00 | Standard Type |

⑦ Packaging

| Code | Packaging |
|------|-------------------------------------|
| -B0 | Bulk |
| -R1 | Embossed Taping $\phi=330\text{mm}$ |

With non-standard products, three-digit alphanumerics indicating "Individual Specification" is added between "⑥ Product Specification Code (2)" and "⑦ Packaging."

⑥ Center Frequency/Tolerance

| Code | Center Frequency | Tolerance |
|------|--|--------------------|
| A | Center Frequency mentioned by specification | $\pm 30\text{kHz}$ |
| B | -30kHz shifted from center frequency of code "A" | $\pm 30\text{kHz}$ |
| C | +30kHz shifted from center frequency of code "A" | $\pm 30\text{kHz}$ |
| D | -60kHz shifted from center frequency of code "A" | $\pm 30\text{kHz}$ |
| E | +60kHz shifted from center frequency of code "A" | $\pm 30\text{kHz}$ |
| H | Center Frequency mentioned by specification | $\pm 25\text{kHz}$ |
| V | -50kHz shifted from center frequency of code "H" | $\pm 25\text{kHz}$ |
| W | +50kHz shifted from center frequency of code "H" | $\pm 25\text{kHz}$ |
| K | Center Frequency mentioned by specification | $\pm 20\text{kHz}$ |
| Z | Combination of A, B, C, D, E | — |
| M | Combination of A, B, C | — |
| F | Nominal Center Frequency | — |

3dB bandwidth of "F" signifies the frequency difference (both + and -) from reference frequency, which is nominal center frequency.

⑦ IC

| Code | IC |
|------|----------------------------|
| 001 | Applicable IC Control Code |

⑧ Packaging

| Code | Packaging |
|------|-------------------------------------|
| -B0 | Bulk |
| -A0 | Radial Taping $H_0=18\text{mm}$ |
| -R0 | Embossed Taping $\phi=180\text{mm}$ |
| -R1 | Embossed Taping $\phi=330\text{mm}$ |

Radial taping is applied to lead type and embossed taping to chip type.
 With non-standard products, an alphanumerics indicating "Individual Specification" is added between "⑦ IC" and "⑧ Packaging."

CERAFIL® (CERAFIL® 10.7MHz) for Audio/Visual Equipment



Small Chip Type SFECF Series

SFECF10M7 series for FM receivers are small, high-performance and super thin (1.4mm max.) filters. The piezoelectric element is sandwiched by the ceramic substrate. They have 1.4mm max. thickness and a small mounting area (3.45x3.1mm). SFECF series and CDSCB series (MHz Discriminator) enable customers to make VICS/RKE/TPMS set very thin and small.

■ Features

1. The filters are mountable by automatic placers.
2. They are slim, at only 1.4mm max. thickness, and have a small mounting area (3.45x3.1mm) enabling flexible PCB design.
3. Various bandwidths are available. Select a suitable type in accordance with the desired selectivity.
4. Operating Temperature Range:
 - 20 to +80°C (Standard Type)
 - 40 to +85°C (High-reliability Type)
 Storage Temperature Range:
 - 40 to +85°C (Standard Type)
 - 55 to +85°C (High-reliability Type)

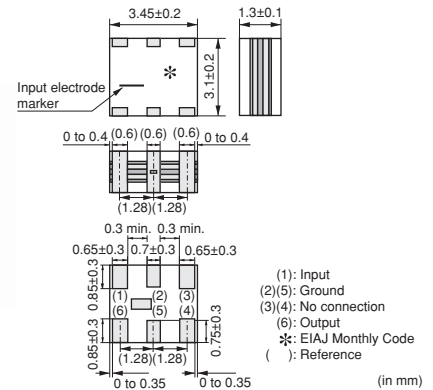

Standard Type

| Part Number | Center Frequency (fo) (MHz) | Nominal Center Frequency (fn) (MHz) | 3dB Bandwidth (kHz) | Attenuation (kHz) | Insertion Loss (dB) | Ripple (dB) | Spurious Attenuation (1) (dB) | Spurious Attenuation (2) (dB) | Input/Output Impedance (ohm) |
|--------------------|-----------------------------|-------------------------------------|---------------------|-------------------|---------------------|-------------|-------------------------------|-------------------------------|------------------------------|
| SFECF10M7HA00-R0 | 10.700 ±30kHz | - | 180 ±40kHz | 470 max. | 4.0±2.0dB | 1.0 max. | 30 min. [within 9MHz to fo] | 30 min. [within fo to 12MHz] | 330 |
| SFECF10M7HF00-R0 | - | 10.700 | fn±25 min. | 510 max. | 8.0max. [at fn] | 1.0 max. | 30 min. [within 9MHz to fn] | 25 min. [within fn to 12MHz] | 330 |
| SFECF10M7GA00-R0 | 10.700 ±30kHz | - | 230 ±50kHz | 510 max. | 3.5±2.0dB | 1.0 max. | 30 min. [within 9MHz to fo] | 30 min. [within fo to 12MHz] | 330 |
| SFECF10M7GF00-R0 | - | 10.700 | fn±45 min. | 560 max. | 8.0max. [at fn] | 1.0 max. | 30 min. [within 9MHz to fn] | 25 min. [within fn to 12MHz] | 330 |
| SFECF10M7FA00-R0 | 10.700 ±30kHz | - | 280 ±50kHz | 590 max. | 3.0±2.0dB | 1.0 max. | 30 min. [within 9MHz to fo] | 30 min. [within fo to 12MHz] | 330 |
| SFECF10M7FF00-R0 | - | 10.700 | fn±65 min. | 620 max. | 7.0max. [at fn] | 1.0 max. | 30 min. [within 9MHz to fn] | 25 min. [within fn to 12MHz] | 330 |
| SFECF10M7EA00-R0 | 10.700 ±30kHz | - | 330 ±50kHz | 700 max. | 3.0±2.0dB | 1.0 max. | 30 min. [within 9MHz to fo] | 30 min. [within fo to 12MHz] | 330 |
| SFECF10M7DA0001-R0 | 10.700 ±30kHz | - | 420 min. | 950 max. | 3.0±2.0dB | 3.0 max. | 35 min. [within 9MHz to fo] | 25 min. [within fo to 12MHz] | 330 |
| SFECF10M7DF00-R0 | - | 10.700 | fn±150 min. | 990 max. | 6.0max. [at fn] | 3.0 max. | 20 min. [within 9MHz to fn] | 20 min. [within fn to 12MHz] | 330 |

Area of Attenuation: [within 20dB]

Area of Insertion Loss: at minimum loss point Area of Ripple: within 3dB B.W.

Center frequency (fo) defined by the center of 3dB bandwidth.

For safety purposes, connect the output of filters to the IF amplifier through a D.C. blocking capacitor. Avoid applying a direct current to the output of ceramic filters.

The order quantity should be an integral multiple of the "Minimum Quantity" shown in the package page.

1

High-Reliability Type

| Part Number | Center Frequency (fo) (MHz) | Nominal Center Frequency (fn) (MHz) | 3dB Bandwidth (kHz) | Attenuation (kHz) | Insertion Loss (dB) | Ripple (dB) | Spurious Attenuation (1) (dB) | Spurious Attenuation (2) (dB) | Input/Output Impedance (ohm) |
|--------------------|-----------------------------|-------------------------------------|---------------------|-------------------|---------------------|-------------|--------------------------------|---------------------------------|------------------------------|
| SFECF10M7HA00S0-R0 | 10.700 ±30kHz | - | 180 ±40kHz | 470 max. | 4.0±2.0dB | 1.0 max. | 30 min. [within 9MHz to fo] | 30 min. [within fo to 12MHz] | 330 |
| SFECF10M7HF00S0-R0 | - | 10.700 | fn±25 min. | 510 max. | 8.0max. [at fn] | 1.0 max. | 30 min. [within 9MHz to fn] | 25 min. [within fn to 12MHz] | 330 |
| SFECF10M7GA00S0-R0 | 10.700 ±30kHz | - | 230 ±50kHz | 510 max. | 3.5±2.0dB | 1.0 max. | 30 min. [within 9MHz to fo] | 30 min. [within fo to 12MHz] | 330 |
| SFECF10M7GF00S0-R0 | - | 10.700 | fn±45 min. | 560 max. | 8.0max. [at fn] | 1.0 max. | 30 min. [within 9MHz to fn] | 25 min. [within fn to 12MHz] | 330 |
| SFECF10M7FA00S0-R0 | 10.700 ±30kHz | - | 280 ±50kHz | 590 max. | 3.0±2.0dB | 1.0 max. | 30 min. [within 9MHz to fo] | 30 min. [within fo to 12MHz] | 330 |
| SFECF10M7FF00S0-R0 | - | 10.700 | fn±65 min. | 630 max. | 7.0max. [at fn] | 1.0 max. | 30 min. [within 9MHz to fn] | 25 min. [within fn to 12MHz] | 330 |
| SFECF10M7EA00S0-R0 | 10.700 ±30kHz | - | 330 ±50kHz | 700 max. | 3.0±2.0dB | 1.0 max. | 30 min. [within 9MHz to fo] | 30 min. [within fo to 12MHz] | 330 |
| SFECF10M7DF00S0-R0 | - | 10.700 | fn±145 min. | 990 max. | 6.0max. [at fn] | 3.0 max. | 20 min. [within 9MHz to fn] | 20 min. [within fn to 12MHz] | 330 |

Area of Attenuation: [within 20dB]

Area of Insertion Loss: at minimum loss point Area of Ripple: within 3dB B.W.

Center frequency (fo) defined by the center of 3dB bandwidth.

For safety purposes, connect the output of filters to the IF amplifier through a D.C. blocking capacitor. Avoid applying a direct current to the output of ceramic filters.

The order quantity should be an integral multiple of the "Minimum Quantity" shown in the package page.

Standard Center Frequency Rank Code

| CODE | 30kHz Step | 25kHz Step |
|------|---------------------------|-----------------|
| D | 10.64MHz±30kHz | 10.650MHz±25kHz |
| B | 10.67MHz±30kHz | 10.675MHz±25kHz |
| A | 10.70MHz±30kHz | 10.700MHz±25kHz |
| C | 10.73MHz±30kHz | 10.725MHz±25kHz |
| E | 10.76MHz±30kHz | 10.750MHz±25kHz |
| Z | Combination A, B, C, D, E | |
| M | Combination A, B, C | |

Standard Land Pattern Dimensions

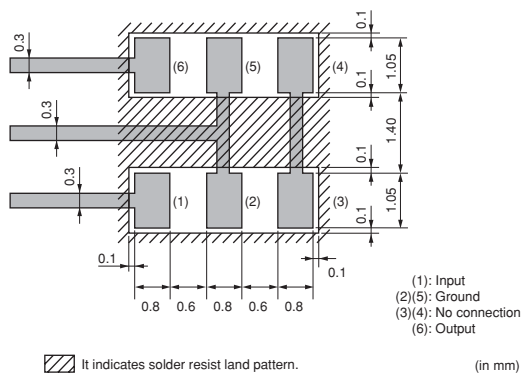

Test Circuit

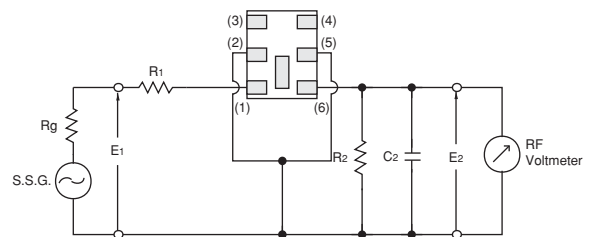

$R_g = 50\Omega$ $R_1 = 280\Omega \pm 5\%$ $R_2 = 330\Omega \pm 5\%$
 $C_2 = 10 \pm 2 \text{ pF}$ (Including stray capacitance and input capacitance of RF voltmeter)
 E1: S.S.G. Output Voltage

(1): Input
 (2)(5): Ground
 (3)(4): No connection
 (6): Output

■ Frequency Characteristics Standard Type

SFECF10M7HA00-R0/SFECF10M7HF00-R0



SFECF10M7GA00-R0/SFECF10M7GF00-R0

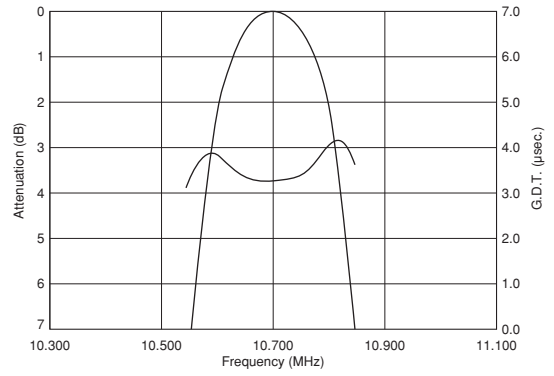

SFECF10M7FA00-R0/SFECF10M7FF00-R0

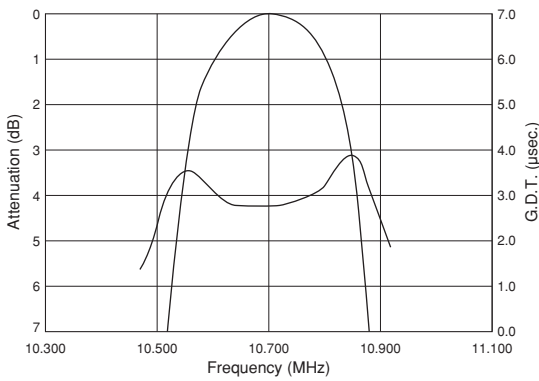

SFECF10M7EA00-R0

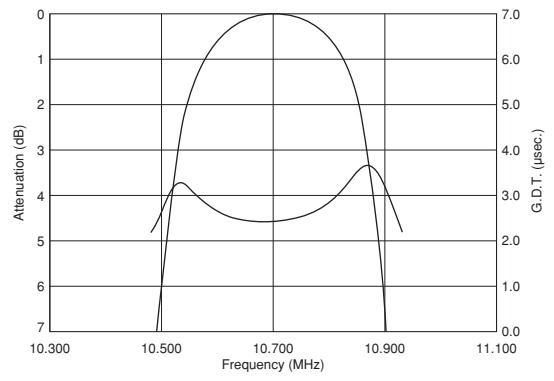

SFECF10M7DA0001-R0

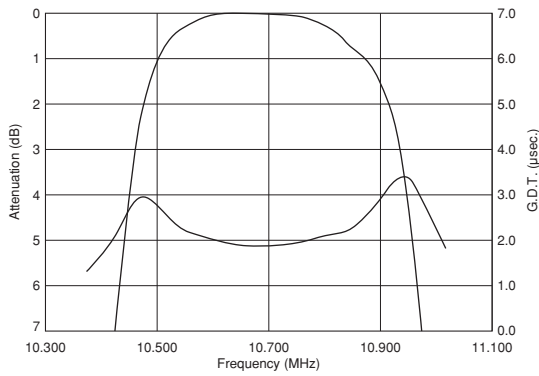

SFECF10M7DF00-R0

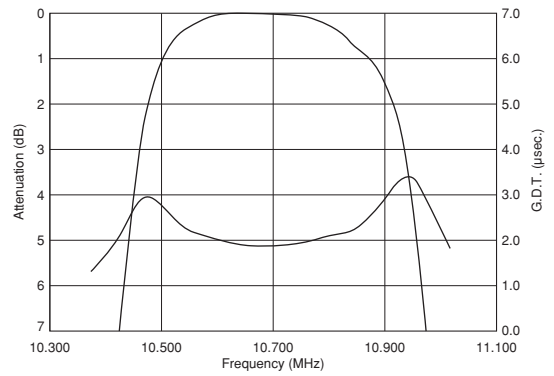

■ Frequency Characteristics High-reliability Type

SFECF10M7HA00S0-R0/SFECF10M7HF00S0-R0



SFECF10M7GA00S0-R0/SFECF10M7GF00S0-R0



SFECF10M7FA00S0-R0/SFECF10M7FF00S0-R0

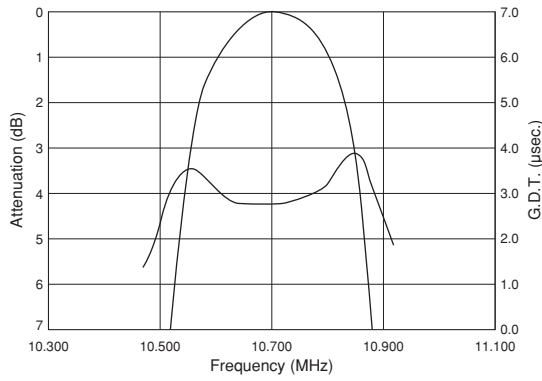

SFECF10M7EA00S0-R0

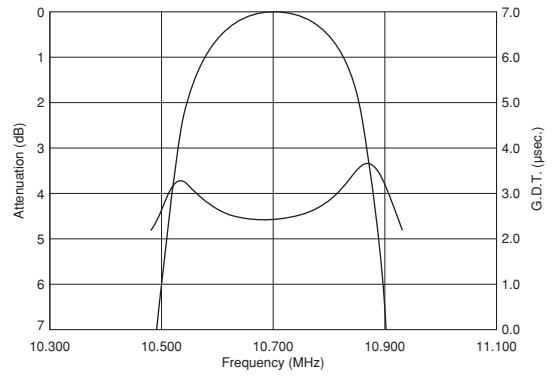

SFECF10M7DF00S0-R0

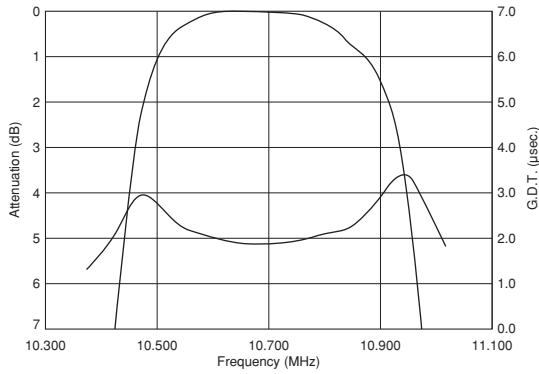

■ Frequency Characteristics (Spurious) Standard Type

SFECF10M7HA00-R0/SFECF10M7HF00-R0



SFECF10M7GA00-R0/SFECF10M7GF00-R0

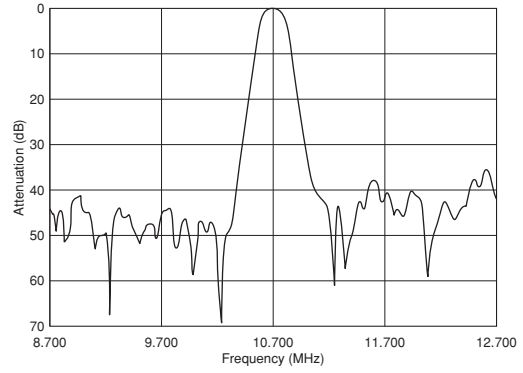

SFECF10M7FA00-R0/SFECF10M7FF00-R0



SFECF10M7EA00-R0

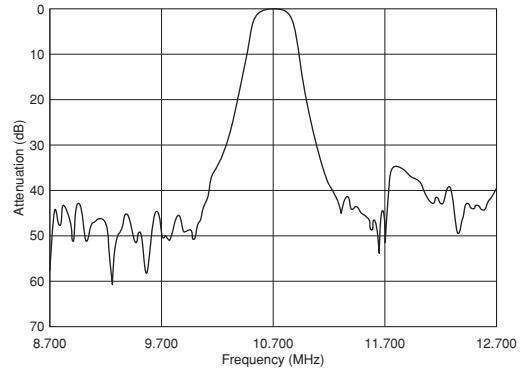

SFECF10M7DA0001-R0/SFECF10M7DF00-R0



■ Frequency Characteristics (Spurious) High-reliability Type

SFECF10M7HA00S0-R0/SFECF10M7HF00S0-R0



SFECF10M7GA00S0-R0/SFECF10M7GF00S0-R0



SFECF10M7FA00S0-R0/SFECF10M7FF00S0-R0



SFECF10M7EA00S0-R0



SFECF10M7DF00S0-R0



CERAFIL® (CERAFIL® 10.7MHz) for Audio/Visual Equipment



Chip Type SFECV/SFECK Series

SFECV/SFECK10M7 series for FM receivers are monolithic type ceramic filters that utilize the thickness expander mode of piezoelectric ceramics. SFECV series enable customers to make an AM/FM set very thin, and it can be useful to the total chip circuit.

■ Features

1. The piezoelectric element is sandwiched by heat resistant substrate, thus it has excellent mechanical strength, and it is suitable for automatic mounting.
2. Various bandwidths are available. Select a suitable type in accordance with the desired selectivity.
3. Operating Temperature Range:
 - 20 to +80°C (Standard Type)
 - 40 to +85°C (High-reliability Type)
 Storage Temperature Range:
 - 40 to +85°C (Standard Type)
 - 55 to +85°C (High-reliability Type)

■ Applications

1. Small, thin radios
2. Automotive radios
3. Headphone stereos



Standard Type

| Part Number | Center Frequency (fo) (MHz) | 3dB Bandwidth (kHz) | Attenuation (kHz) | Insertion Loss (dB) | Ripple (dB) | Spurious Attenuation (1) (dB) | Spurious Attenuation (2) (dB) | Input/Output Impedance (ohm) |
|--------------------|-----------------------------|---------------------|-------------------|---------------------|-------------|-------------------------------|-------------------------------|------------------------------|
| SFECV15M0EQ0001-R0 | 15.000 ±50kHz | 300 min. | 750 max. | 7.0max. | 1.0 max. | 30 min. [within 14MHz to fo] | 30 min. [within fo to 16MHz] | 330 |
| SFECV10M7KA00-R0 | 10.700 ±30kHz | 110 ±30kHz | 320 max. | 6.0±2.0dB | 1.0 max. | 35 min. [within 9MHz to fo] | 35 min. [within fo to 12MHz] | 330 |
| SFECV10M7JA00-R0 | 10.700 ±30kHz | 150 ±40kHz | 380 max. | 5.5±2.0dB | 1.0 max. | 35 min. [within 9MHz to fo] | 35 min. [within fo to 12MHz] | 330 |

Area of Attenuation: [within 20dB]

Area of Insertion Loss: at minimum loss point

Center frequency (fo) defined by the center of 3dB bandwidth.

For safety purposes, connect the output of filters to the IF amplifier through a D.C. blocking capacitor. Avoid applying a direct current to the output of ceramic filters.

The order quantity should be an integral multiple of the "Minimum Quantity" shown in the package page.

High-Reliability Type

| Part Number | Center Frequency (fo) (MHz) | 3dB Bandwidth (kHz) | Attenuation (kHz) | Insertion Loss (dB) | Ripple (dB) | Spurious Attenuation (1) (dB) | Spurious Attenuation (2) (dB) | Input/Output Impedance (ohm) |
|--------------------|-----------------------------|---------------------|-------------------|---------------------|-------------|-------------------------------|-------------------------------|------------------------------|
| SFECK10M7KA00S0-R0 | 10.700 ±30kHz | 110 ±30kHz | 320 max. | 6.0±2.0dB | 1.0 max. | 35 min. [within 9MHz to fo] | 35 min. [within fo to 12MHz] | 330 |
| SFECK10M7JA00S0-R0 | 10.700 ±30kHz | 150 ±40kHz | 380 max. | 5.5±2.0dB | 1.0 max. | 35 min. [within 9MHz to fo] | 35 min. [within fo to 12MHz] | 330 |

Area of Attenuation: [within 20dB]

Area of Insertion Loss: at minimum loss point

Center frequency (fo) defined by the center of 3dB bandwidth.

For safety purposes, connect the output of filters to the IF amplifier through a D.C. blocking capacitor. Avoid applying a direct current to the output of ceramic filters.

The order quantity should be an integral multiple of the "Minimum Quantity" shown in the package page.

2

Standard Center Frequency Rank Code

| CODE | 30kHz Step | 25kHz Step |
|------|---------------------------|-----------------|
| D | 10.64MHz±30kHz | 10.650MHz±25kHz |
| B | 10.67MHz±30kHz | 10.675MHz±25kHz |
| A | 10.70MHz±30kHz | 10.700MHz±25kHz |
| C | 10.73MHz±30kHz | 10.725MHz±25kHz |
| E | 10.76MHz±30kHz | 10.750MHz±25kHz |
| Z | Combination A, B, C, D, E | |
| M | Combination A, B, C | |

Standard Land Pattern Dimensions



Test Circuit



$R_g = 50\Omega$ $R_1 = 280\Omega \pm 5\%$ $R_2 = 330\Omega \pm 5\%$
 $C_2 = 10 \pm 2 \text{ pF}$ (Including stray capacitance and Input capacitance of RF voltmeter)
 E1 : S.S.G. Output Voltage
 (1) : Input
 (2) : Ground
 (3) : Output

Frequency Characteristics Standard Type

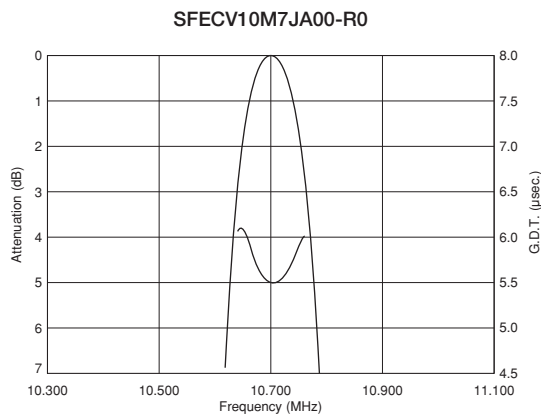
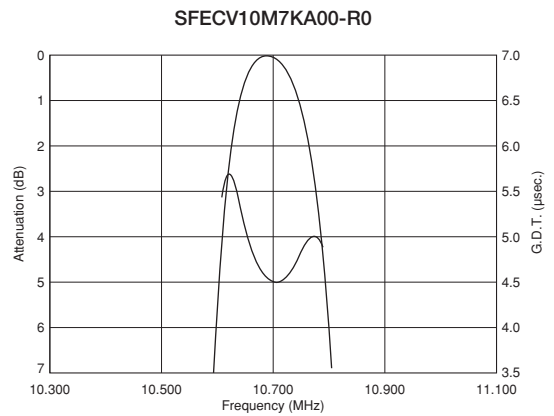
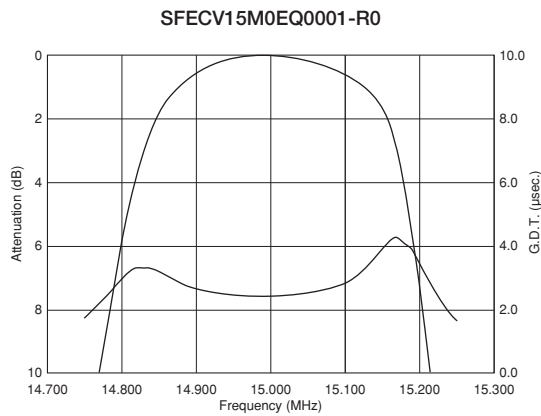

■ Frequency Characteristics High-reliability Type

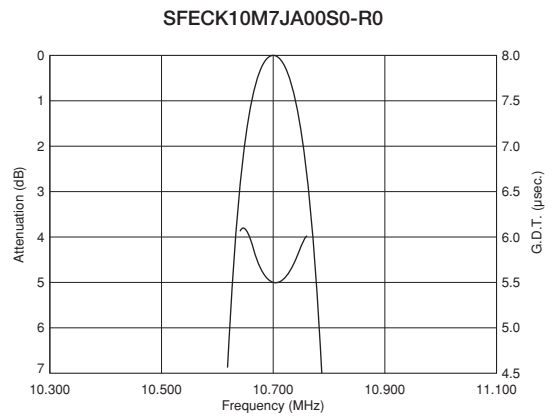
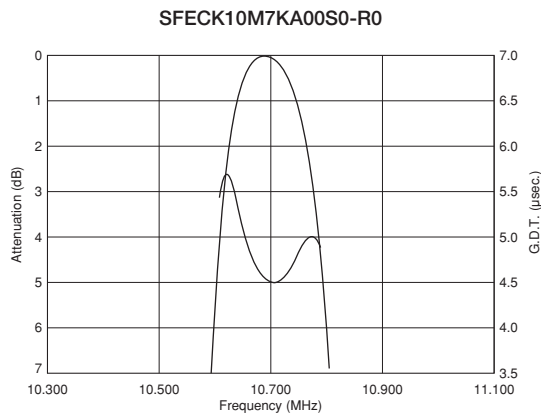

■ Frequency Characteristics (Spurious) Standard Type

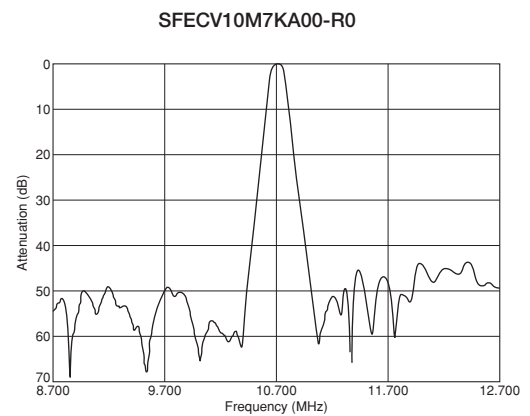
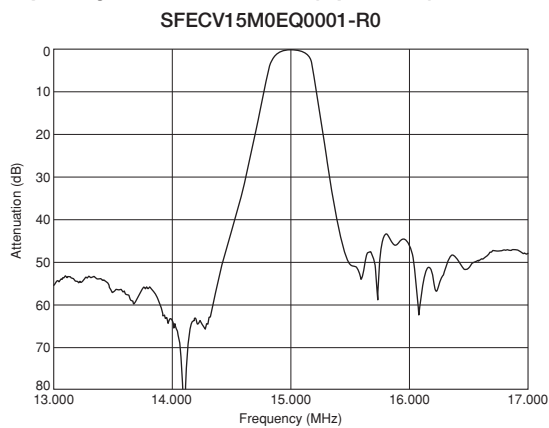

■ Frequency Characteristics (Spurious) High-reliability Type

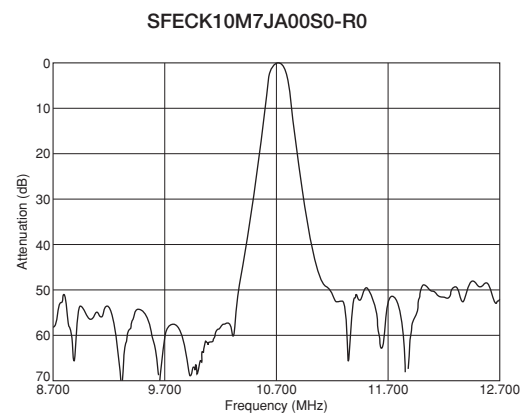
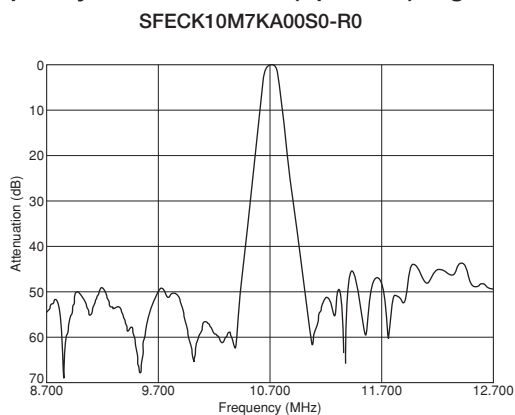

CERAFIL® (CERAFIL® 10.7MHz) for Audio/Visual Equipment



Standard Lead Type SFELF Series

3

SFELF10M7 series for FM-receivers are monolithic type ceramic filters that use the thickness expander mode of the piezoelectric ceramic.

As part of the environment protection program, the solder for terminal plating and terminal-element connection inside of the ceramic filter contain no lead (Pb).

■ Features

1. These miniature filters have high mechanical strength.
2. Low loss, favorable waveform symmetry, and high selectivity
3. Various bandwidths are available for applications in wide to narrow bands.
4. Small dispersion and stable characteristics
5. Change in center frequency is typically within $\pm 30\text{ppm}/^\circ\text{C}$ at -20 to $+80^\circ\text{C}$.
6. High reliability



SFELF10M7HA00-B0



SFELF10M7GA00-B0

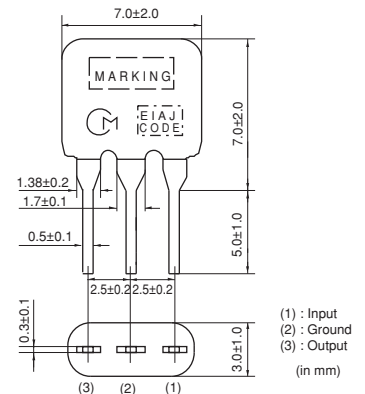

SFELF10M7FA00-B0



| Part Number | Center Frequency (fo) (MHz) | 3dB Bandwidth (kHz) | Attenuation (kHz) | Insertion Loss (dB) | Spurious Attenuation (1) (dB) | Spurious Attenuation (2) (dB) | Input/Output Impedance (ohm) |
|------------------|-----------------------------|---------------------|-------------------|---------------------|-------------------------------|-------------------------------|------------------------------|
| SFELF10M7HA00-B0 | 10.700 ±30kHz | 180 ±40kHz | 520 max. | 7.0max. | 40 min. [within 9MHz to fo] | 40 min. [within fo to 12MHz] | 330 |
| SFELF10M7GA00-B0 | 10.700 ±30kHz | 230 ±50kHz | 570 max. | 4.0±2.0dB | 40 min. [within 9MHz to fo] | 40 min. [within fo to 12MHz] | 330 |
| SFELF10M7FA00-B0 | 10.700 ±30kHz | 280 ±50kHz | 650 max. | 4.0±2.0dB | 30 min. [within 9MHz to fo] | 30 min. [within fo to 12MHz] | 330 |

Area of Attenuation: [within 20dB]

Area of Insertion Loss: at minimum loss point

Center frequency (fo) defined by the center of 3dB bandwidth.

For safety purposes, connect the output of filters to the IF amplifier through a D.C. blocking capacitor. Avoid applying a direct current to the output of ceramic filters.

The order quantity should be an integral multiple of the "Minimum Quantity" shown in the package page.

Standard Center Frequency Rank Code

| CODE | 30kHz Step | 25kHz Step | Color Code |
|------|---------------------------|-----------------|------------|
| D | 10.64MHz±30kHz | 10.650MHz±25kHz | Black |
| B | 10.67MHz±30kHz | 10.675MHz±25kHz | Blue |
| A | 10.70MHz±30kHz | 10.700MHz±25kHz | Red |
| C | 10.73MHz±30kHz | 10.725MHz±25kHz | Orange |
| E | 10.76MHz±30kHz | 10.750MHz±25kHz | White |
| Z | Combination A, B, C, D, E | | |
| M | Combination A, B, C | | |

Test Circuit

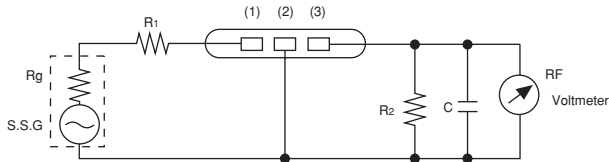

$R_g + R_1 = R_2 =$ Input and Output Impedance
 $C = 10\text{pF}$ (Including stray capacitance and input capacitance of RF voltmeter.)

(1) : Input
 (2) : Ground
 (3) : Output

Frequency Characteristics

SFELF10M7HA00-B0



SFELF10M7GA00-B0

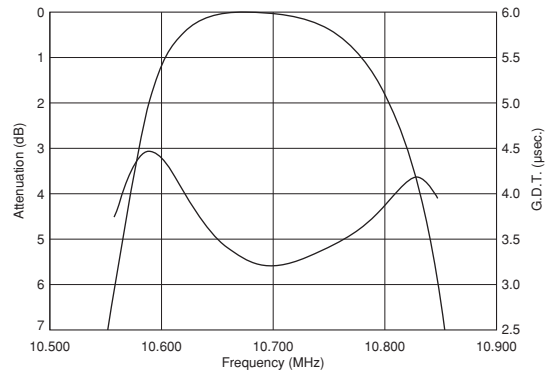

SFELF10M7FA00-B0



■ Frequency Characteristics (Spurious)

SFELF10M7HA00-B0



SFELF10M7GA00-B0



SFELF10M7FA00-B0



3

CERAFIL® (CERAFIL® 10.7MHz) for Audio/Visual Equipment



Low Loss Type SFELF Series

SFELF10M7 series for FM receivers are monolithic type ceramic filters that use the thickness expander mode of the piezoelectric ceramic.

As part of the environment protection program, the solder for terminal plating and terminal-element connection inside of the ceramic filter contain no lead (Pb).

■ Features

1. Insertion loss is 1 to 1.5dB lower than conventional products. These types are useful for elevating the sensitivity of sets.
2. Small dispersion and stable characteristics
3. Excellent shape factor of frequency response
4. Good waveform symmetry



SFELF10M7JAA0-B0

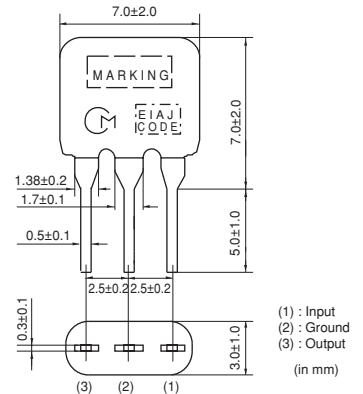

SFELF10M7HAA0-B0

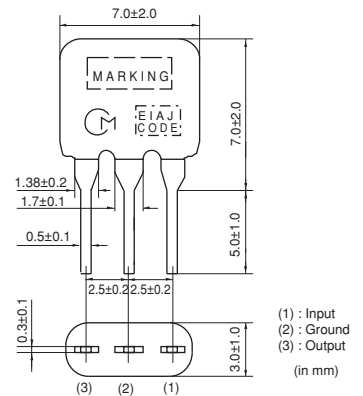

SFELF10M7GAA0-B0



SFELF10M7FAA0-B0

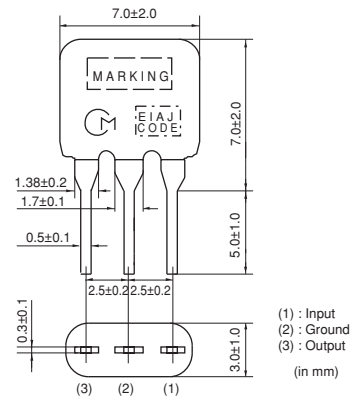

| Part Number | Center Frequency (fo) (MHz) | 3dB Bandwidth (kHz) | Attenuation (kHz) | Insertion Loss (dB) | Spurious Attenuation (1) (dB) | Spurious Attenuation (2) (dB) | Input/Output Impedance (ohm) |
|------------------|-----------------------------|---------------------|-------------------|---------------------|-------------------------------|-------------------------------|------------------------------|
| SFELF10M7JAA0-B0 | 10.700 ±30kHz | 150 ±40kHz | 360 max. | 4.5±2.0dB | 35 min. [within 9MHz to fo] | 35 min. [within fo to 12MHz] | 330 |
| SFELF10M7HAA0-B0 | 10.700 ±30kHz | 180 ±40kHz | 470 max. | 3.5±1.5dB | 35 min. [within 9MHz to fo] | 35 min. [within fo to 12MHz] | 330 |
| SFELF10M7GAA0-B0 | 10.700 ±30kHz | 230 ±50kHz | 520 max. | 3.0±2.0dB | 35 min. [within 9MHz to fo] | 35 min. [within fo to 12MHz] | 330 |
| SFELF10M7FAA0-B0 | 10.700 ±30kHz | 280 ±50kHz | 590 max. | 2.5±2.0dB | 30 min. [within 9MHz to fo] | 30 min. [within fo to 12MHz] | 330 |

Area of Attenuation: [within 20dB]

Area of Insertion Loss: at minimum loss point

Center frequency (fo) defined by the center of 3dB bandwidth.

For safety purposes, connect the output of filters to the IF amplifier through a D.C. blocking capacitor. Avoid applying a direct current to the output of ceramic filters.

The order quantity should be an integral multiple of the "Minimum Quantity" shown in the package page.

Standard Center Frequency Rank Code

| CODE | 30kHz Step | 25kHz Step | Color Code |
|------|---------------------------|-----------------|------------|
| D | 10.64MHz±30kHz | 10.650MHz±25kHz | Black |
| B | 10.67MHz±30kHz | 10.675MHz±25kHz | Blue |
| A | 10.70MHz±30kHz | 10.700MHz±25kHz | Red |
| C | 10.73MHz±30kHz | 10.725MHz±25kHz | Orange |
| E | 10.76MHz±30kHz | 10.750MHz±25kHz | White |
| Z | Combination A, B, C, D, E | | |
| M | Combination A, B, C | | |

Test Circuit

4



$R_g + R_1 = R_2 =$ Input and Output Impedance
 $C = 10\text{pF}$ (Including stray capacitance and input capacitance of RF voltmeter.)

(1) : Input
 (2) : Ground
 (3) : Output

Frequency Characteristics

SFELF10M7JAA0-B0



SFELF10M7HAA0-B0



SFELF10M7GAA0-B0



SFELF10M7FAA0-B0



■ Frequency Characteristics (Spurious)

SFELF10M7JAA0-B0



SFELF10M7HAA0-B0



SFELF10M7GAA0-B0



SFELF10M7FAA0-B0



4

CERAFIL® (CERAFIL® 10.7MHz) for Audio/Visual Equipment



Low Spurious Response Type SFELF Series

SFELF10M7 series for FM-receivers are monolithic type ceramic filters that use the thickness expander mode of the piezoelectric ceramic.

As part of the environment protection program, the solder for terminal plating and terminal-element connection inside of the ceramic filter contain no lead (Pb).

■ Features

These types have lower spurious response compared to standard filters.

5



SFELF10M7KAB0-B0

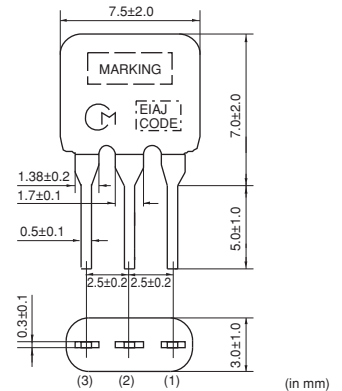

SFELF10M7JAB0-B0

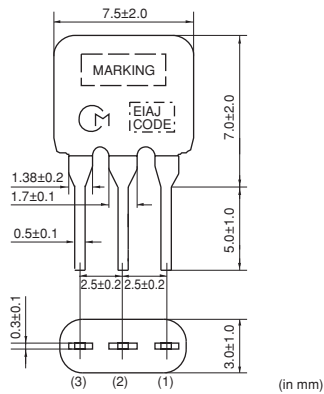

SFELF10M7HAB0-B0

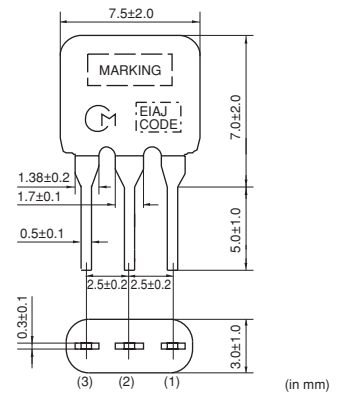

SFELF10M7GAB0-B0

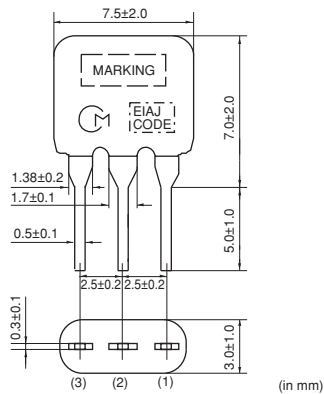

SFELF10M7FAB0-B0

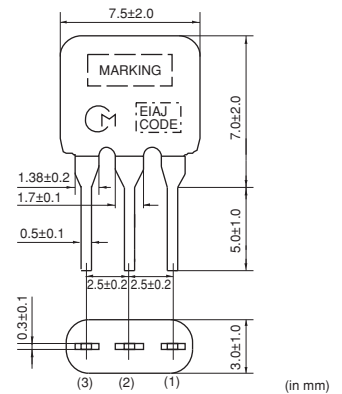

| Part Number | Center Frequency (fo) (MHz) | 3dB Bandwidth (kHz) | Attenuation (kHz) | Insertion Loss (dB) | Spurious Attenuation (1) (dB) | Spurious Attenuation (2) (dB) | Input/Output Impedance (ohm) |
|------------------|-----------------------------|---------------------|-------------------|---------------------|-----------------------------------|---------------------------------|------------------------------|
| SFELF10M7KAB0-B0 | 10.700 ±30kHz | 110 ±30kHz | 350 max. | 7.0±2.0dB | 45/30 min. [within 9MHz to fo] | 30 min. [within fo to 12MHz] | 330 |
| SFELF10M7JAB0-B0 | 10.700 ±30kHz | 150 ±40kHz | 380 max. | 5.5±2.0dB | 45 min. [within 9MHz to fo] | 45 min. [within fo to 12MHz] | 330 |
| SFELF10M7HAB0-B0 | 10.700 ±30kHz | 180 ±40kHz | 520 max. | 5.0±2.0dB | 45 min. [within 9MHz to fo] | 45 min. [within fo to 12MHz] | 330 |
| SFELF10M7GAB0-B0 | 10.700 ±30kHz | 230 ±50kHz | 570 max. | 3.0±2.0dB | 45 min. [within 9MHz to fo] | 45 min. [within fo to 12MHz] | 330 |

Continued on the following page. ↗

Continued from the preceding page.

| Part Number | Center Frequency (fo) (MHz) | 3dB Bandwidth (kHz) | Attenuation (kHz) | Insertion Loss (dB) | Spurious Attenuation (1) (dB) | Spurious Attenuation (2) (dB) | Input/Output Impedance (ohm) |
|------------------|-----------------------------|---------------------|-------------------|---------------------|--------------------------------|---------------------------------|------------------------------|
| SFELF10M7FAB0-B0 | 10.700 ±30kHz | 280 ±50kHz | 650 max. | 3.0±2.0dB | 45 min. [within 9MHz to fo] | 45 min. [within fo to 12MHz] | 330 |

Area of Attenuation: [within 20dB]

Area of Insertion Loss: at minimum loss point

Center frequency (fo) defined by the center of 3dB bandwidth.

For safety purposes, connect the output of filters to the IF amplifier through a D.C. blocking capacitor. Avoid applying a direct current to the output of ceramic filters.

The order quantity should be an integral multiple of the "Minimum Quantity" shown in the package page.

Standard Center Frequency Rank Code

| CODE | 30kHz Step | 25kHz Step | Color Code |
|------|---------------------------|-----------------|------------|
| D | 10.64MHz±30kHz | 10.650MHz±25kHz | Black |
| B | 10.67MHz±30kHz | 10.675MHz±25kHz | Blue |
| A | 10.70MHz±30kHz | 10.700MHz±25kHz | Red |
| C | 10.73MHz±30kHz | 10.725MHz±25kHz | Orange |
| E | 10.76MHz±30kHz | 10.750MHz±25kHz | White |
| Z | Combination A, B, C, D, E | | |
| M | Combination A, B, C | | |

Test Circuit



$R_g + R_1 = R_2 =$ Input and Output Impedance
 $C = 10\text{pF}$ (Including stray capacitance and input capacitance of RF voltmeter.)

- (1) : Input
- (2) : Ground
- (3) : Output

Frequency Characteristics

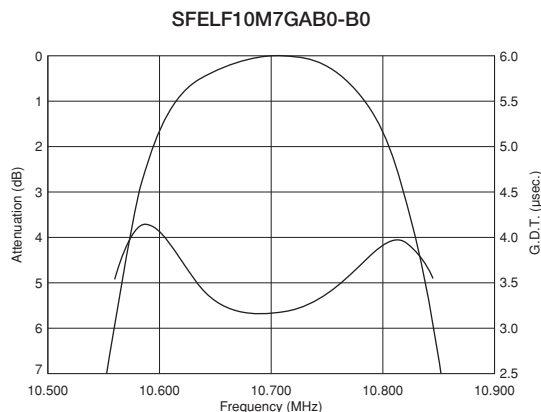
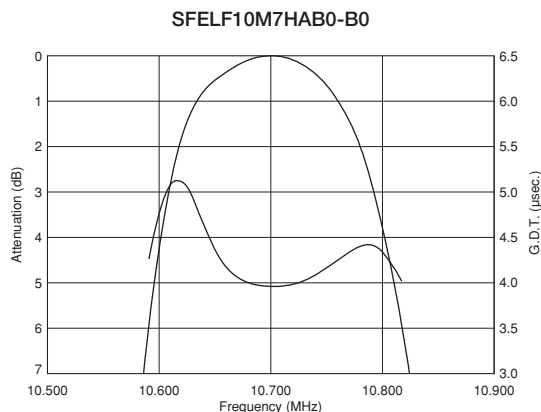
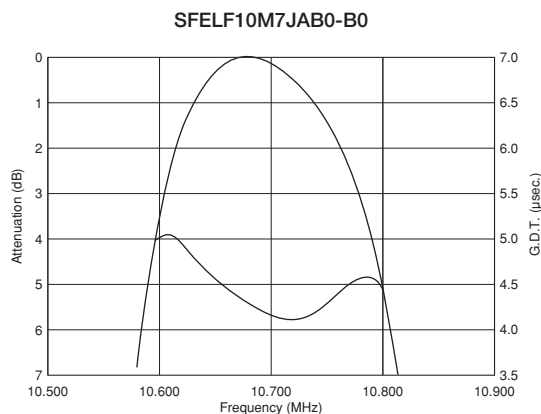
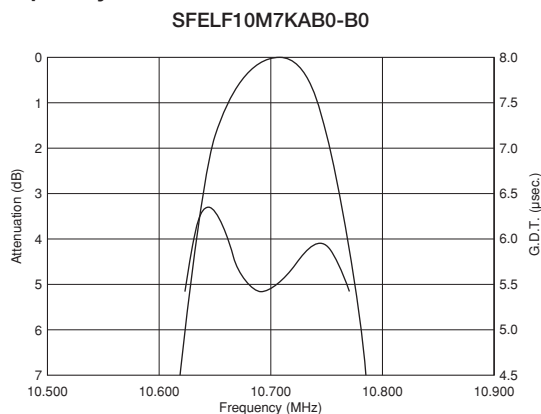

Continued on the following page. ↗

☐ Continued from the preceding page.

■ Frequency Characteristics

SFELF10M7FAB0-B0

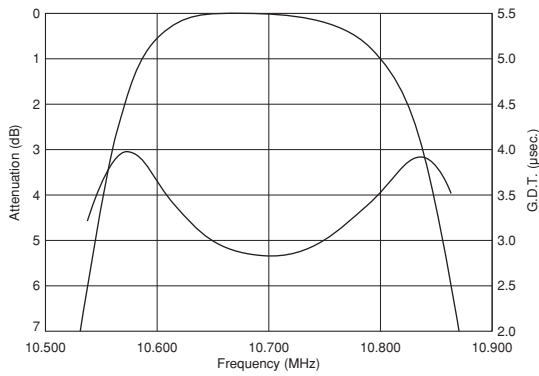

5

■ Frequency Characteristics (Spurious)

SFELF10M7KAB0-B0



SFELF10M7JAB0-B0



SFELF10M7HAB0-B0

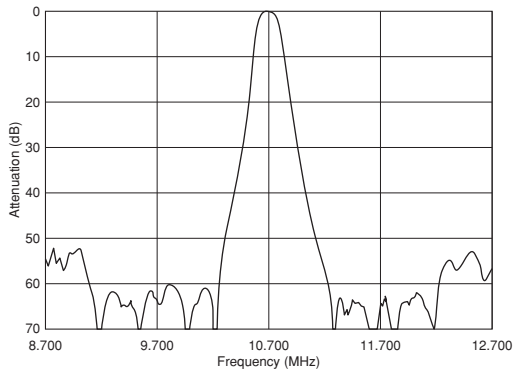

SFELF10M7GAB0-B0



SFELF10M7FAB0-B0

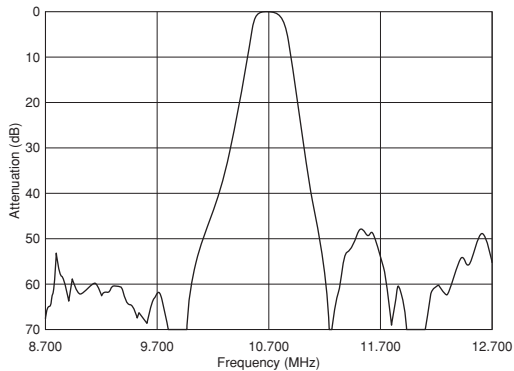

CERAFIL® (CERAFIL® 10.7MHz) for Audio/Visual Equipment



Wide Bandwidth Type SFELF Series

SFELF10M7 series for FM-receivers are monolithic type ceramic filters that use the thickness expander mode of the piezoelectric ceramic.

As part of the environment protection program, the solder for terminal plating and terminal-element connection inside of the ceramic filter contain no lead (Pb).

■ Features

Realizes wider band characteristics not obtained by conventional ceramic filters.



SFELF10M7EA00-B0

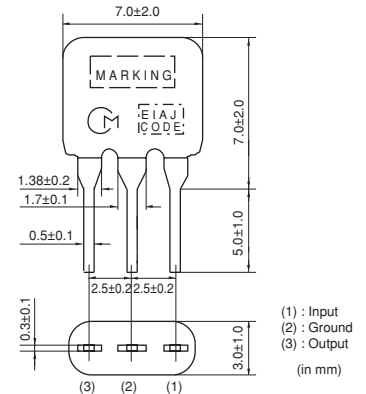

SFELF10M7DF00-B0



| Part Number | Center Frequency (fo) (MHz) | Nominal Center Frequency (fn) (MHz) | 3dB Bandwidth (kHz) | Attenuation (kHz) | Insertion Loss (dB) | Spurious Attenuation (1) (dB) | Spurious Attenuation (2) (dB) | Input/Output Impedance (ohm) |
|------------------|-----------------------------|-------------------------------------|---------------------|-------------------|---------------------|-------------------------------|-------------------------------|------------------------------|
| SFELF10M7EA00-B0 | 10.700 ±30kHz | - | 330 ±50kHz | 680 max. | 4.0±2.0dB | 30 min. [within 9MHz to fo] | 30 min. [within fo to 12MHz] | 330 |
| SFELF10M7DF00-B0 | - | 10.700 | fn±175 min. | 950 max. | 3.0±2.0dB | 20 min. [within 5MHz to fn] | 20 min. [within fn to 15MHz] | 470 |

Area of Attenuation: [within 20dB]

Area of Insertion Loss: at minimum loss point

Center frequency (fo) defined by the center of 3dB bandwidth.

For safety purposes, connect the output of filters to the IF amplifier through a D.C. blocking capacitor. Avoid applying a direct current to the output of ceramic filters.

The order quantity should be an integral multiple of the "Minimum Quantity" shown in the package page.

■ Standard Center Frequency Rank Code (SFELF10M7EA00-B0)

| CODE | 30kHz Step | 25kHz Step | Color Code |
|------|---------------------------|-----------------|------------|
| D | 10.64MHz±30kHz | 10.650MHz±25kHz | Black |
| B | 10.67MHz±30kHz | 10.675MHz±25kHz | Blue |
| A | 10.70MHz±30kHz | 10.700MHz±25kHz | Red |
| C | 10.73MHz±30kHz | 10.725MHz±25kHz | Orange |
| E | 10.76MHz±30kHz | 10.750MHz±25kHz | White |
| Z | Combination A, B, C, D, E | | |
| M | Combination A, B, C | | |

■ Test Circuit



$R_g + R_1 = R_2 =$ Input and Output Impedance
 $C = 10\text{pF}$ (Including stray capacitance and input capacitance of RF voltmeter.)

- (1) : Input
- (2) : Ground
- (3) : Output

■ Frequency Characteristics

SFELF10M7EA00-B0



SFELF10M7DF00-B0



■ Frequency Characteristics (Spurious)

SFELF10M7EA00-B0



SFELF10M7DF00-B0

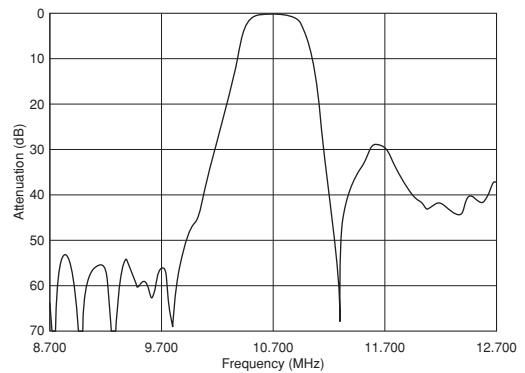

CERAFIL® (CERAFIL® 10.7MHz) for Audio/Visual Equipment



Narrow Bandwidth Type SFELF Series

■ Features

SFELF10M7LFTA/KAH0 series realizes narrower band characteristics not obtained by conventional ceramic filters. Besides, low spurious and temperature characteristics are stable. This series is suitable for European car-audio or AM upconversion use that needs stable narrow band characteristics. As part of the environment protection program, the solder for terminal plating and terminal-element connection inside of the ceramic filter contain no lead (Pb).

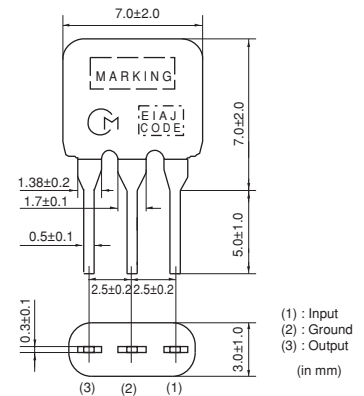
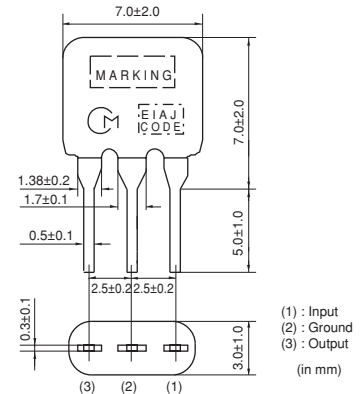

| Part Number | Center Frequency (fo) (MHz) | Nominal Center Frequency (fn) (MHz) | 3dB Bandwidth (kHz) | Attenuation (kHz) | Insertion Loss (dB) | Spurious Attenuation (1) (dB) | Spurious Attenuation (2) (dB) | Input/Output Impedance (ohm) |
|------------------|-----------------------------|-------------------------------------|---------------------|-------------------|---------------------|--------------------------------|---------------------------------|------------------------------|
| SFELF10M7LFTA-B0 | - | 10.700 | fn±25 min. | 280 max. | 7.0±2.0dB | 30 min. [within 9MHz to fn] | 30 min. [within fn to 12MHz] | 330 |
| SFELF10M7KAH0-B0 | 10.700 ±30kHz | - | 110 ±30kHz | 350 max. | 7.0±2.0dB | 30 min. [within 9MHz to fo] | 30 min. [within fo to 12MHz] | 330 |

Area of Attenuation: [within 20dB]

Area of Insertion Loss: at minimum loss point

Center frequency (fo) defined by the center of 3dB bandwidth.

For safety purposes, connect the output of filters to the IF amplifier through a D.C. blocking capacitor. Avoid applying a direct current to the output of ceramic filters.

The order quantity should be an integral multiple of the "Minimum Quantity" shown in the package page.

■ Standard Center Frequency Rank Code (SFELF10M7KAH0-B0)

| CODE | 30kHz Step | 25kHz Step | Color Code |
|------|---------------------------|-----------------|------------|
| D | 10.64MHz±30kHz | 10.650MHz±25kHz | Black |
| B | 10.67MHz±30kHz | 10.675MHz±25kHz | Blue |
| A | 10.70MHz±30kHz | 10.700MHz±25kHz | Red |
| C | 10.73MHz±30kHz | 10.725MHz±25kHz | Orange |
| E | 10.76MHz±30kHz | 10.750MHz±25kHz | White |
| Z | Combination A, B, C, D, E | | |
| M | Combination A, B, C | | |

■ Test Circuit



$R_g + R_1 = R_2 =$ Input and Output Impedance
 $C = 10\text{pF}$ (Including stray capacitance and input capacitance of RF voltmeter.)

- (1) : Input
- (2) : Ground
- (3) : Output

■ Frequency Characteristics

SFELF10M7LFTA-B0



SFELF10M7KAH0-B0



■ Frequency Characteristics (Spurious)

SFELF10M7LFTA-B0

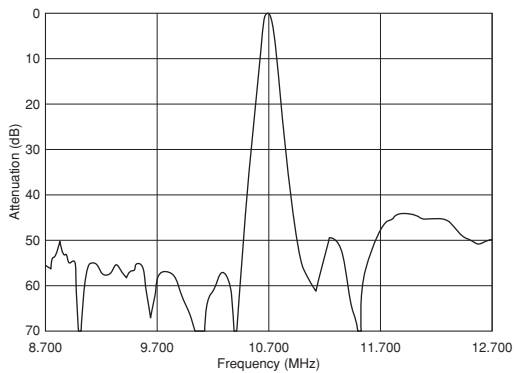

SFELF10M7KAH0-B0

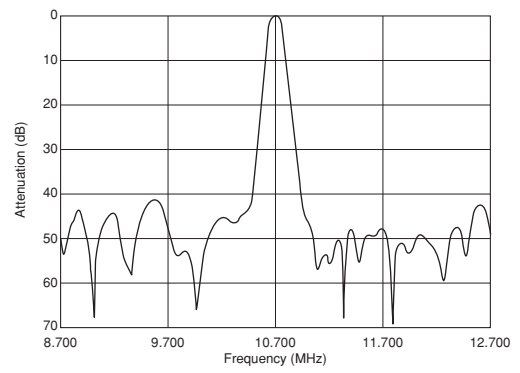

7

CERAFIL® (CERAFIL® 10.7MHz) for Audio/Visual Equipment



For FM-IF Tuners SFELF Series

SFELF10M7 series for FM-receivers are monolithic type ceramic filters that use the thickness expander mode of the piezoelectric ceramic.

As part of the environment protection program, the solder for terminal plating and terminal-element connection inside of the ceramic filter contain no lead (Pb).

■ Features

1. Little dispersion of amplitude characteristics and phase characteristics (G. D. T. characteristics)
2. The SFELF_G series is based on SFELF_FA00/GA00/HA00, and it obtains high selectivity with low loss. There is little dispersion of amplitude and GDT characteristics, and low distortion rate can be obtained.
3. The flatness of GDT is inspected for all products.



SFELF10M7HA0G-B0

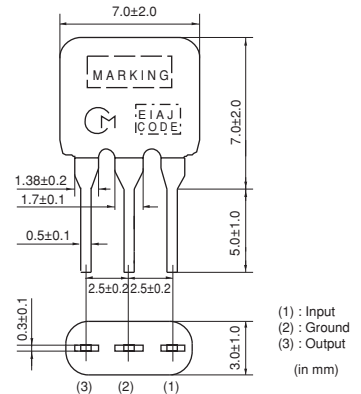

SFELF10M7GA0G-B0

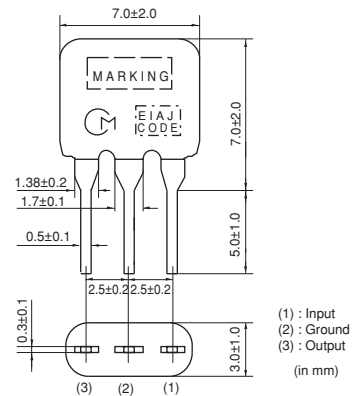

SFELF10M7FA0G-B0

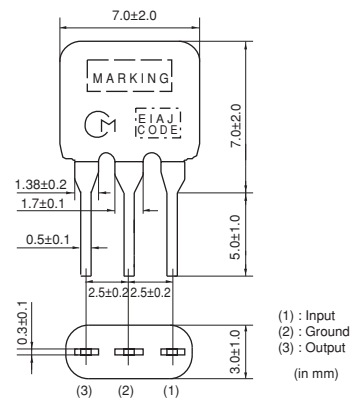

| Part Number | Center Frequency (fo) (MHz) | 3dB Bandwidth (kHz) | Attenuation (kHz) | Insertion Loss (dB) | Spurious Attenuation (1) (dB) | Spurious Attenuation (2) (dB) | GDT Bandwidth (kHz) | Input/Output Impedance (ohm) |
|------------------|-----------------------------|---------------------|-------------------|---------------------|-------------------------------|-------------------------------|---------------------|------------------------------|
| SFELF10M7HA0G-B0 | 10.700 ±30kHz | 180 ±40kHz | 520 max. | 7.0max. | 40 min. [within 9MHz to fo] | 40 min. [within fo to 12MHz] | fo±45min. | 330 |
| SFELF10M7GA0G-B0 | 10.700 ±30kHz | 230 ±50kHz | 600 max. | 7.0max. | 40 min. [within 9MHz to fo] | 40 min. [within fo to 12MHz] | fo±60min. | 330 |
| SFELF10M7FA0G-B0 | 10.700 ±30kHz | 280 ±50kHz | 650 max. | 4.0±2.0dB | 30 min. [within 9MHz to fo] | 30 min. [within fo to 12MHz] | fo±85min. | 330 |

Area of Attenuation: [within 20dB]

Area of Insertion Loss: at minimum loss point

Center frequency (fo) defined by the center of 3dB bandwidth.

For safety purposes, connect the output of filters to the IF amplifier through a D.C. blocking capacitor. Avoid applying a direct current to the output of ceramic filters.

The order quantity should be an integral multiple of the "Minimum Quantity" shown in the package page.

Standard Center Frequency Rank Code

| CODE | 30kHz Step | 25kHz Step | Color Code |
|------|---------------------------|-----------------|------------|
| D | 10.64MHz±30kHz | 10.650MHz±25kHz | Black |
| B | 10.67MHz±30kHz | 10.675MHz±25kHz | Blue |
| A | 10.70MHz±30kHz | 10.700MHz±25kHz | Red |
| C | 10.73MHz±30kHz | 10.725MHz±25kHz | Orange |
| E | 10.76MHz±30kHz | 10.750MHz±25kHz | White |
| Z | Combination A, B, C, D, E | | |
| M | Combination A, B, C | | |

Test Circuit

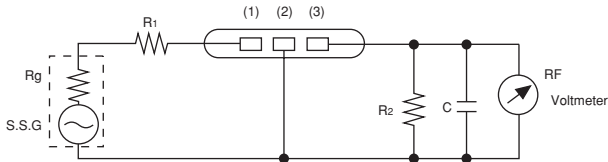

$R_g + R_1 = R_2 =$ Input and Output Impedance
 $C = 10\text{pF}$ (Including stray capacitance and input capacitance of RF voltmeter.)

(1) : Input
 (2) : Ground
 (3) : Output

Frequency Characteristics

SFELF10M7HA0G-B0



SFELF10M7GA0G-B0

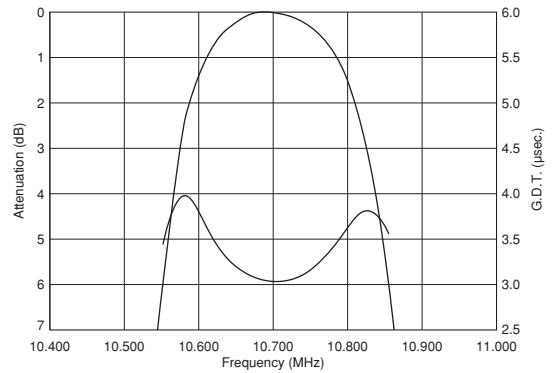

SFELF10M7FA0G-B0



■ Frequency Characteristics (Spurious)

SFELF10M7HA0G-B0



SFELF10M7GA0G-B0



SFELF10M7FA0G-B0



CERAFIL® 10.7MHz Related Data on Lead Type

Temperature Characteristics



Matching Conditions

- When using ceramic filters, it is most important to match the input/output load to impedance 330 ohm (SFELF10M7DF00-B0 is 470 ohm).
 Waveform symmetry is damaged when reactance is added to the input/output load.
- Two ceramic filters directly connected can be used for high selectivity. For reducing waveform variation, it is recommended to input a buffer AMP between ceramic filters.

- The SFELF10M7 series are of input/output symmetric structure so that in theory there is no input/output directionality. Actual circuits may use different input/output loading conditions (for example, mismatched impedance) or capacitance load. In such cases, the waveform will be a little changed by the direction of the input/output of the ceramic filters.

Loaded Resistance and Waveform (Rg+R1=330 ohm)

SFELF10M7GA00-B0



Loaded Capacitance and Waveform (Rg+R1=R2=330 ohm)

SFELF10M7HA00-B0



CERAFIL® (CERAFIL® 2.3-6.5MHz) for Audio/Visual Equipment



4.5-6.5MHz Chip Type SFSKA Series

SMD ceramic filter SFSKA_CF is a small and thin SMD filter sealed with a metal cap.
 Recommended for LCD-TVs, and small and thin tuners.

■ Features

1. High attenuation outside bandwidth
2. Small and thin package
3. Reflow-solderable



| Part Number | Nominal Center Frequency (fn) (MHz) | 3dB Bandwidth (kHz) | 20dB Bandwidth (kHz) | Insertion Loss (dB) | Spurious Attenuation(1) (dB) | Spurious Attenuation(2) (dB) | Input/Output Impedance (ohm) |
|------------------|-------------------------------------|---------------------|----------------------|---------------------|------------------------------|-------------------------------|------------------------------|
| SFSKA4M50CF00-R3 | 4.500 | fn±60 min. | 600 max. | 6.0 max. | 20 min. [within 0 to fn] | 15 min. [within fn to 7.0MHz] | 1000 |
| SFSKA5M50CF00-R3 | 5.500 | fn±60 min. | 600 max. | 6.0 max. | 25 min. [within 0 to fn] | 15 min. [within fn to 7.0MHz] | 600 |
| SFSKA6M00CF00-R3 | 6.000 | fn±60 min. | 600 max. | 6.0 max. | 25 min. [within 0 to fn] | 15 min. [within fn to 7.5MHz] | 470 |
| SFSKA6M50CF00-R3 | 6.500 | fn±60 min. | 600 max. | 6.0 max. | 25 min. [within 0 to fn] | 15 min. [within fn to 8.5MHz] | 470 |

Area of Insertion Loss: at minimum loss point

For safety purposes, connect the output of filters to the IF amplifier through a D.C. blocking capacitor. Avoid applying a direct current to the output of ceramic filters.
 The order quantity should be an integral multiple of the "Minimum Quantity" shown in the package page.

■ Standard Land Pattern Dimensions

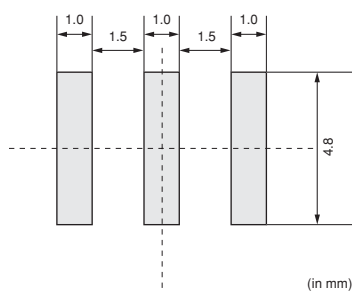

■ Test Circuit

SFSKA4M50CF00-R3



Continued on the following page.

☞ Continued from the preceding page.

■ Test Circuit

SFSKA5M50CF00-R3



$R1+Rg=R2=600\Omega \pm 5\%$, $Rg=50\Omega$
 $C2=10pF$ (Including stray capacitance and Input capacitance of RF Voltmeter)
 E1: S.S.G. Output voltage
 (1) : Input
 (2) : Ground
 (3) : Output

SFSKA6M00CF00-R3

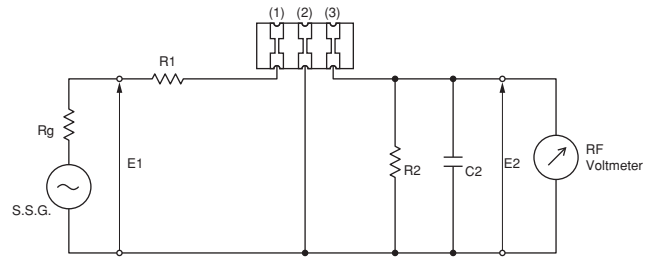

$R1+Rg=R2=470\Omega \pm 5\%$, $Rg=50\Omega$
 $C2=10pF$ (Including stray capacitance and Input capacitance of RF Voltmeter)
 E1: S.S.G. Output voltage
 (1) : Input
 (2) : Ground
 (3) : Output

SFSKA6M50CF00-R3



$R1+Rg=R2=470\Omega \pm 5\%$, $Rg=50\Omega$
 $C2=10pF$ (Including stray capacitance and Input capacitance of RF Voltmeter)
 E1: S.S.G. Output voltage
 (1) : Input
 (2) : Ground
 (3) : Output

■ Frequency Characteristics

SFSKA4M50CF00-R3



SFSKA5M50CF00-R3

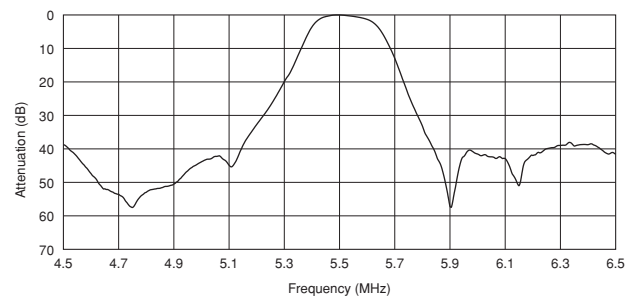

SFSKA6M00CF00-R3

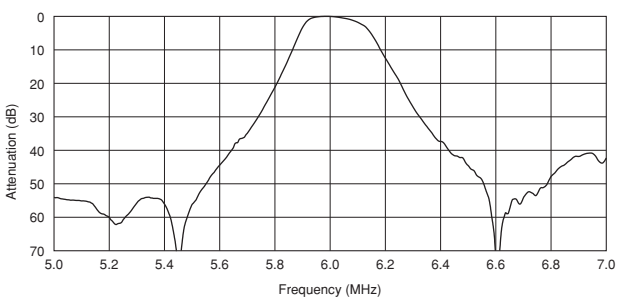

SFSKA6M50CF00-R3

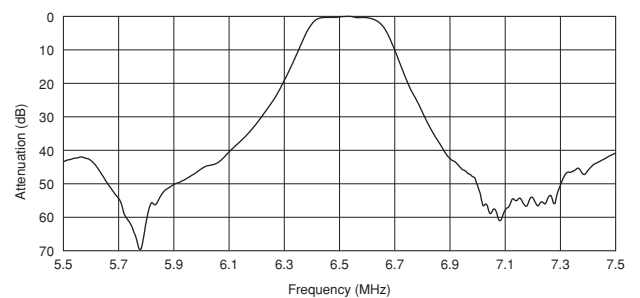

9

■ Frequency Characteristics (Spurious)

SFSKA4M50CF00-R3



SFSKA5M50CF00-R3

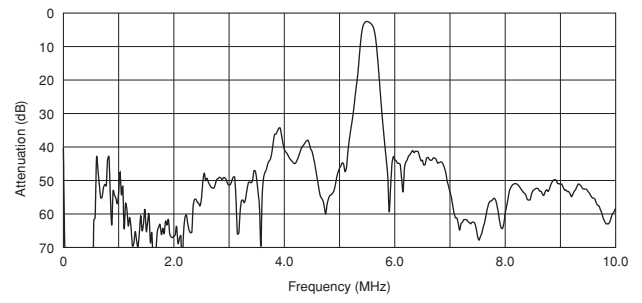

SFSKA6M00CF00-R3



SFSKA6M50CF00-R3

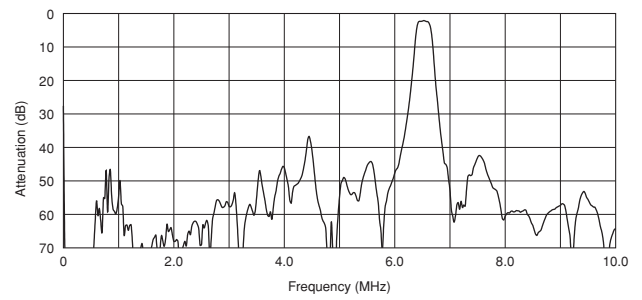

CERAFIL® (CERAFIL® 2.3-6.5MHz) for Audio/Visual Equipment



2.3-5.7MHz Chip Type SFSKB Series

The SFSKB series are SMD ceramic filters suitable for IR headphone applications.

Center frequencies of 2.3, 2.8, 3.2, 3.8, 4.3, 4.8, 5.2, 5.7MHz are available.

Realized small, thin and lightweight package, compared with conventional LC filters.

It helps to compose multi-channel circuit on one PCB.

No frequency adjustment is required on PCB and it contributes to the reduction of production cost.

■ Features

1. SMD package in plastic emboss tape, available for automatic placing.
2. They are slim, at only 1.5mm max. thickness, and have a small mounting area (5.2x3.8mm) enabling flexible PCB design.
3. Available for lead (Pb) free reflow soldering process.
4. Operating temperature range: 0 to +70°C
Storage temperature range: -55 to +85°C
5. No frequency adjustment is required in production process.
6. Small, thin and lightweight package compared with conventional LC filters

■ Applications

1. IR headphone
2. Set Top Box for satellite broadcasting

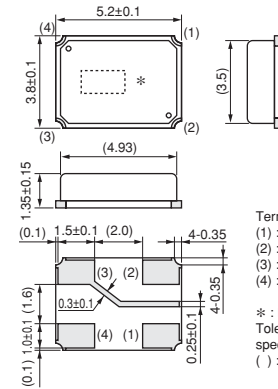

10

| Part Number | Nominal Center Frequency (fn) (MHz) | 3dB Bandwidth (kHz) | 20dB Bandwidth (kHz) | Insertion Loss (dB) | Spurious Attenuation(1) (dB) | Spurious Attenuation(2) (dB) | Input/Output Impedance (ohm) |
|------------------|-------------------------------------|---------------------|----------------------|---------------------|-----------------------------------|-----------------------------------|------------------------------|
| SFSKB2M30GF00-R1 | 2.300 | fn±75 min. | 650 max. | 6.0 max. | 25 min. [within 1.3 to 1.8MHz] | 23 min. [within 2.8 to 3.3MHz] | 1000 |
| SFSKB2M80GF00-R1 | 2.800 | fn±75 min. | 650 max. | 6.0 max. | 25 min. [within 1.8 to 2.3MHz] | 25 min. [within 3.3 to 3.8MHz] | 1000 |
| SFSKB3M20FF00-R1 | 3.200 | fn±75 min. | 650 max. | 6.0 max. | 30 min. [within 2.2 to 2.8MHz] | 30 min. [within 3.8 to 4.2MHz] | 1000 |
| SFSKB3M80GF00-R1 | 3.800 | fn±75 min. | 650 max. | 6.0 max. | 30 min. [within 2.8 to 3.2MHz] | 30 min. [within 4.3 to 4.8MHz] | 1000 |
| SFSKB4M30GF00-R1 | 4.300 | fn±75 min. | 650 max. | 6.0 max. | 30 min. [within 3.3 to 3.8MHz] | 30 min. [within 4.8 to 5.3MHz] | 1000 |
| SFSKB4M80GF00-R1 | 4.800 | fn±75 min. | 650 max. | 6.0 max. | 30 min. [within 3.8 to 4.3MHz] | 30 min. [within 5.2 to 5.8MHz] | 1000 |
| SFSKB5M20GF00-R1 | 5.200 | fn±75 min. | 650 max. | 6.0 max. | 30 min. [within 4.2 to 4.8MHz] | 30 min. [within 5.7 to 6.2MHz] | 1000 |
| SFSKB5M70GF00-R1 | 5.700 | fn±75 min. | 650 max. | 6.0 max. | 30 min. [within 4.7 to 5.2MHz] | 30 min. [within 6.2 to 6.7MHz] | 1000 |

For safety purposes, connect the output of filters to the IF amplifier through a D.C. blocking capacitor. Avoid applying a direct current to the output of ceramic filters.
 The order quantity should be an integral multiple of the "Minimum Quantity" shown in the package page.

Standard Land Pattern Dimensions



(in mm)

Test Circuit

SFSKB2M30GF00-R1/SFSKB3MZ0GF00-R1



$R1+Rg=R2=1.0k\Omega$
 $Cc=22pF\pm5\%$
 $C2=10pF$ (Including stray capacitance and Input capacitance of RF Voltmeter)
 E1 : S.S.G. Output Voltage

(1) : Input
 (2) : Output
 (3) : Ground
 (4) : Terminal for external capacitor

SFSKB2M80GF00-R1/SFSKB3M20FF00-R1

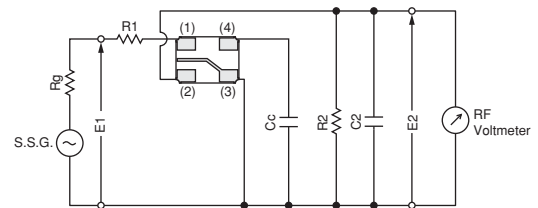

$R1+Rg=R2=1.0k\Omega$
 $Cc=39pF\pm5\%$
 $C2=10pF$ (Including stray capacitance and Input capacitance of RF Voltmeter)
 E1 : S.S.G. Output Voltage

(1) : Input
 (2) : Output
 (3) : Ground
 (4) : Terminal for external capacitor

SFSKB4M30GF00-R1/SFSKB5M70GF00-R1



$R1+Rg=R2=1.0k\Omega$
 $Cc=33pF\pm5\%$
 $C2=10pF$ (Including stray capacitance and Input capacitance of RF Voltmeter)
 E1 : S.S.G. Output Voltage

(1) : Input
 (2) : Output
 (3) : Ground
 (4) : Terminal for external capacitor

SFSKB4M80GF00-R1

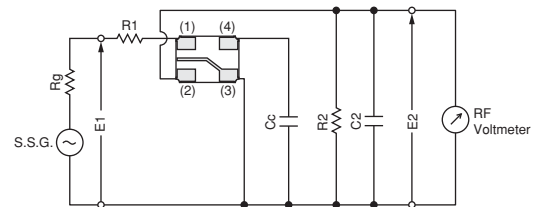

$R1+Rg=R2=1.0k\Omega$
 $Cc=15pF\pm5\%$
 $C2=10pF$ (Including stray capacitance and Input capacitance of RF Voltmeter)
 E1 : S.S.G. Output Voltage

(1) : Input
 (2) : Output
 (3) : Ground
 (4) : Terminal for external capacitor

SFSKB5M20GF00-R1



$R1+Rg=R2=1.0k\Omega$
 $Cc=27pF\pm5\%$
 $C2=10pF$ (Including stray capacitance and Input capacitance of RF Voltmeter)
 E1 : S.S.G. Output Voltage

(1) : Input
 (2) : Output
 (3) : Ground
 (4) : Terminal for external capacitor

10

■ Frequency Characteristics

SFSKB2M30GF00-R1



SFSKB2M80GF00-R1



SFSKB3M20FF00-R1



SFSKB3M80GF00-R1



SFSKB4M30GF00-R1



SFSKB4M80GF00-R1



SFSKB5M20GF00-R1



SFSKB5M70GF00-R1



10

■ Frequency Characteristics (Spurious)

SFSKB2M30GF00-R1



SFSKB2M80GF00-R1

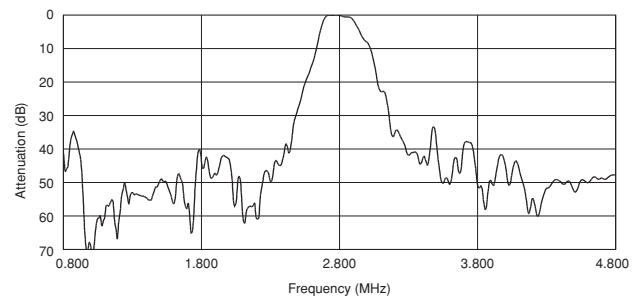

SFSKB3M20FF00-R1



SFSKB3M80GF00-R1

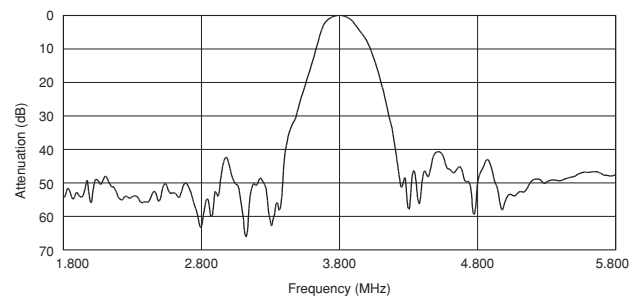

SFSKB4M30GF00-R1



SFSKB4M80GF00-R1

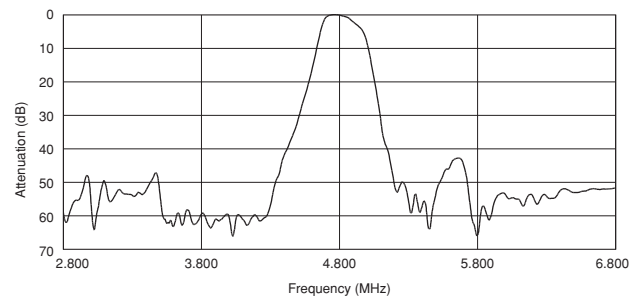

SFSKB5M20GF00-R1



SFSKB5M70GF00-R1

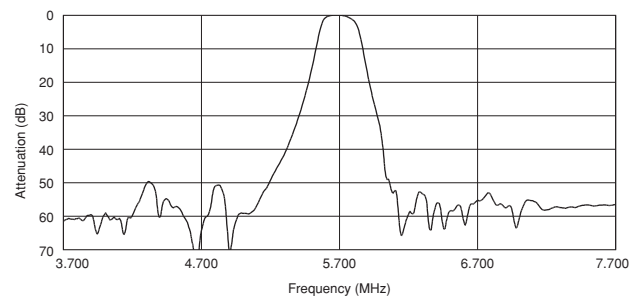

10

CERAFIL® (CERAFIL® 455kHz) for Audio/Visual Equipment



Chip Type SFPKA Series

SFPKA series for AM use is one of the most recommendable intermediate filters, having such distinctive features as high selectivity, high stability and adjustment-free operation. Additionally, its easy matching with IC helps create an easy circuit design.

■ Features

1. The filters are mountable by automatic placers and can be reflow soldered and withstand washing.
2. The filters are wide bandwidth and high selectivity, so they are suitable for car radio and multi-band radio.



| Part Number | Center Frequency (fo) (kHz) | 6dB Bandwidth (kHz) | Selectivity (-) (dB) | Selectivity (+) (dB) | Insertion Loss (dB) | Input/Output Impedance (ohm) | Element |
|-----------------|-----------------------------|---------------------|----------------------|----------------------|---------------------|------------------------------|---------|
| SFPKA450KH1A-R1 | 450.0 ±1.0kHz | fn±3.0 min. | 40 min.[fn-9kHz] | 40 min.[fn+9kHz] | 6.0 max. | 2000 | 4 |
| SFPKA450KG1A-R1 | 450.0 ±1.0kHz | fn±4.5 min. | 40 min.[fn-10kHz] | 40 min.[fn+10kHz] | 6.0 max. | 1500 | 4 |

Area of Insertion Loss: at minimum loss point

Center frequency (fo) is defined by the center of 6dB bandwidth.

(fn) means nominal center frequency (450kHz).

For safety purposes, connect the output of filters to the IF amplifier through a D.C. blocking capacitor. Avoid applying a direct current to the output of ceramic filters.

The order quantity should be an integral multiple of the "Minimum Quantity" shown in the package page.

■ Standard Land Pattern Dimensions



■ Recommended IFT

| Item | Type | SFPKA | | |
|-----------------------|-------------------|---------|---------|---------|
| | | (1)-(2) | (2)-(3) | (4)-(6) |
| Winding Specification | (Bottom view) | | | |
| | | 60T | 125T | 28T |
| No load Qu | | 40 | | |
| Tuning Capacitance | | 180pF | | |

• Matching of CERAFIL® SFPKA series with IFT is decided by the Qu of IFT and IFT secondary side impedance, |Z2|. Set the Qu at about 40 because a Qu value which is too high (e.g., 90) may produce ripple in the waveform. It is recommended to match the impedance of |Z2| with that of the CERAFIL®.

■ Test Circuit



■ Frequency Characteristics

SFPKA450KH1A-R1



SFPKA450KG1A-R1

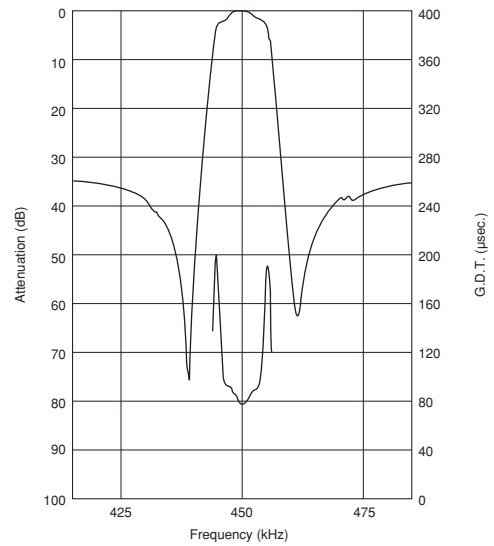

CERAFIL® (CERAFIL® 455kHz) for Audio/Visual Equipment



Lead Type SFPLA/CFWLA Series

SFPLA/CFWLA series for AM use is one of the most suitable intermediate filters, having such distinctive features as high selectivity, high stability, high attenuation, and adjustment-free operation. Additionally, its easy matching with IC helps create an easy circuit design. This is the most suitable for car stereo and all band radio with high attenuation.



SFPLA Series



CFWLA Series

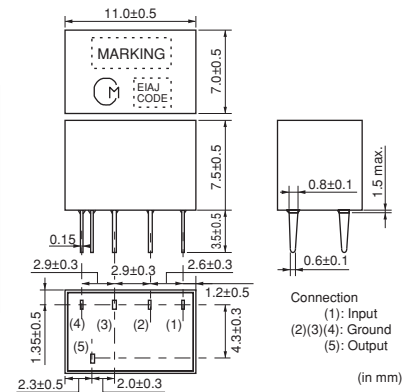

| Part Number | Center Frequency (fo) (kHz) | 6dB Bandwidth (kHz) | Selectivity (-) (dB) | Selectivity (+) (dB) | Insertion Loss (dB) | Input/Output Impedance (ohm) | Element |
|-----------------|-----------------------------|---------------------|----------------------|----------------------|---------------------|------------------------------|---------|
| SFPLA450KJ1A-B0 | 450.0 ±1.0kHz | fn±2.0 min. | 40 min.[fn-7.5kHz] | 40 min.[fn+7.5kHz] | 6.0 max. | 2000 | 4 |
| SFPLA450KH1A-B0 | 450.0 ±1.0kHz | fn±3.0 min. | 40 min.[fn-9kHz] | 40 min.[fn+9kHz] | 6.0 max. | 2000 | 4 |
| CFWLA450KJFA-B0 | 450.0 (fn) | fn±2.0 min. | 50 min.[fn-7.5kHz] | 50 min.[fn+7.5kHz] | 7.0 max. | 2000 | 6 |
| CFWLA450KHFA-B0 | 450.0 (fn) | fn±3.0 min. | 50 min.[fn-9kHz] | 50 min.[fn+9kHz] | 6.0 max. | 2000 | 6 |

Area of Insertion Loss: at minimum loss point

Center frequency (fo) is defined by the center of 6dB bandwidth.

(fn) means nominal center frequency (450kHz).

For safety purposes, connect the output of filters to the IF amplifier through a D.C. blocking capacitor. Avoid applying a direct current to the output of ceramic filters.

The order quantity should be an integral multiple of the "Minimum Quantity" shown in the package page.

12

Recommended IFT

| Item | Type | SFPLA/CFWLA | | |
|-----------------------|------|-------------|---------|---------|
| | | 7x7mm IFT | | |
| Winding Specification | | (1)–(2) | (2)–(3) | (4)–(6) |
| S(3) (2) (1) | | 60T | 125T | 28T |
| No load Qu | | 40 | | |
| Tuning Capacitance | | 180pF | | |

• Matching of CERAFIL® SFPLA/CFWLA series with IFT is decided by the Qu of IFT and IFT secondary side impedance, |Z2|. Set the Qu at about 40 because a Qu value which is too high (e.g., 90) may produce ripple in the waveform. It is recommended to match the impedance of |Z2| with that of the CERAFIL®.

Test Circuit

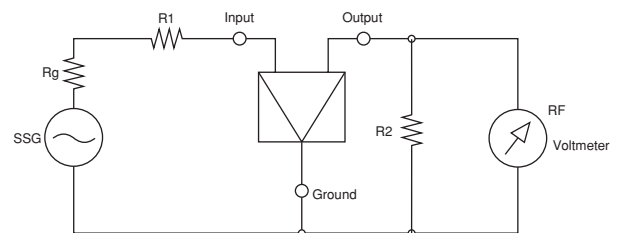

Rg+R1 = R2 : Input/Output Impedance

■ Frequency Characteristics

IFT+SFPLA450KH1A-B0

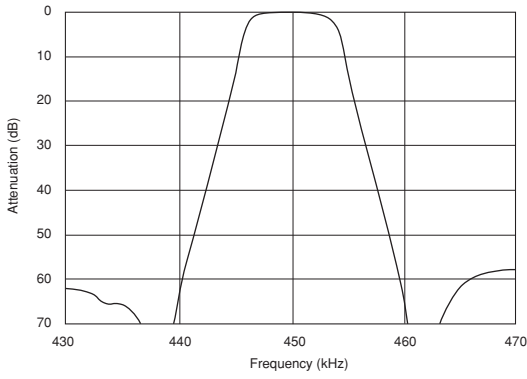

IFT+CFWLA450KHFA-B0



■ Frequency Characteristics (Spurious)

IFT+SFPLA450KH1A-B0



IFT+CFWLA450KHFA-B0



CERAFIL® (CERAFIL® 455kHz) for Audio/Visual Equipment



For AM Stereo Wide Bandwidth Type SFPLA/CFWLA/CFULA Series

SFPLA/CFULA/CFWLA series for AM use is one of the most suitable intermediate filters, having such distinctive features as high selectivity, high stability, high attenuation, and adjustment-free operation. Additionally, its easy matching with IC helps create an easy circuit design.

Especially, CFULA/CFWLA_Y series improves the frequency fidelity in the high sound area of an AM stereo with its wide band and flat characteristics of group delay time.



SFPLA Series



CFWLA Series

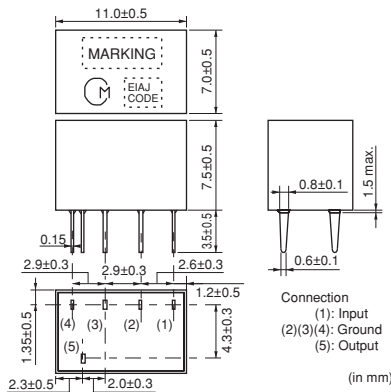

CFULA Series

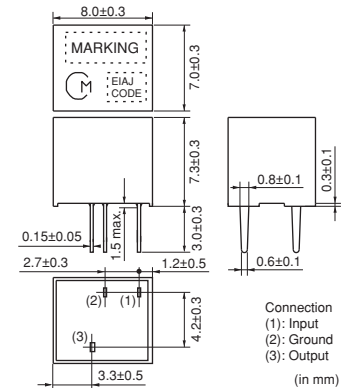

| Part Number | Center Frequency (fo) (kHz) | 6dB Bandwidth (kHz) | Selectivity (-) (dB) | Selectivity (+) (dB) | Insertion Loss (dB) | GDT 20µsec. Bandwidth (kHz) | Input/Output Impedance (ohm) | Element |
|-----------------|-----------------------------|---------------------|----------------------|----------------------|---------------------|-----------------------------|------------------------------|---------|
| SFPLA450KG1A-B0 | 450.0 ±1.0kHz | fn±4.5 min. | 30 min.[fn-9kHz] | 30 min.[fn+9kHz] | 6.0 max. | - | 2000 | 4 |
| SFPLA450KF1A-B0 | 450.0 ±1.0kHz | fn±6.0 min. | 40 min.[fn-12.5kHz] | 40 min.[fn+12.5kHz] | 6.0 max. | - | 2000 | 4 |
| SFPLA450KE1A-B0 | 450.0 ±1.0kHz | fn±7.5 min. | 40 min.[fn-15kHz] | 40 min.[fn+15kHz] | 6.0 max. | - | 1500 | 4 |
| SFPLA450KD1A-B0 | 450.0 ±1.0kHz | fn±10.0 min. | 40 min.[fn-20kHz] | 40 min.[fn+20kHz] | 4.0 max. | - | 1500 | 4 |
| CFULA450KG1Y-B0 | 450.0 ±1.0kHz | fn±4.5 min. | 40 min.[fn-15kHz] | 40 min.[fn+15kHz] | 10.0 max. | fn±3 | 2000 | 4 |
| CFULA450KF1Y-B0 | 450.0 ±1.0kHz | fn±6.0 min. | 40 min.[fn-17.5kHz] | 40 min.[fn+17.5kHz] | 9.0 max. | fn±4 | 2000 | 4 |
| CFULA450KD1Y-B0 | 450.0 ±1.0kHz | fn±10.0 min. | 40 min.[fn-25kHz] | 40 min.[fn+25kHz] | 7.0 max. | fn±7 | 1500 | 4 |
| CFWLA450KG1Y-B0 | 450.0 ±1.0kHz | fn±4.5 min. | 50 min.[fn-15kHz] | 50 min.[fn+15kHz] | 11.0 max. | fn±4 | 2000 | 6 |
| CFWLA450KF1Y-B0 | 450.0 ±1.0kHz | fn±6.0 min. | 50 min.[fn-17.5kHz] | 50 min.[fn+17.5kHz] | 10.0 max. | fn±5 | 2000 | 6 |
| CFWLA450KD1Y-B0 | 450.0 ±1.0kHz | fn±10.0 min. | 50 min.[fn-25kHz] | 50 min.[fn+25kHz] | 8.0 max. | fn±8 | 1500 | 6 |
| CFWLA450KGFA-B0 | 450.0 (fn) | fn±4.5 min. | 50 min.[fn-10kHz] | 50 min.[fn+10kHz] | 6.0 max. | - | 2000 | 6 |
| CFWLA450KFFA-B0 | 450.0 (fn) | fn±6.0 min. | 50 min.[fn-12.5kHz] | 50 min.[fn+12.5kHz] | 6.0 max. | - | 2000 | 6 |
| CFWLA450KEFA-B0 | 450.0 (fn) | fn±7.5 min. | 50 min.[fn-15kHz] | 50 min.[fn+15kHz] | 6.0 max. | - | 1500 | 6 |
| CFWLA450KDFA-B0 | 450.0 (fn) | fn±10.0 min. | 50 min.[fn-20kHz] | 50 min.[fn+20kHz] | 4.0 max. | - | 1500 | 6 |

Area of Insertion Loss: at minimum loss point
 Center frequency (fo) is defined by the center of 6dB bandwidth.
 (fn) means nominal center frequency (450kHz).

For safety purposes, connect the output of filters to the IF amplifier through a D.C. blocking capacitor. Avoid applying a direct current to the output of ceramic filters.
 The order quantity should be an integral multiple of the "Minimum Quantity" shown in the package page.

13

■ Recommended IFT

| Item | Type | SFPLA/CFULA/CFWLA | | |
|-------------------------------------|---|-------------------|---------|---------|
| | | 7x7mm IFT | | |
| Winding Specification | | (1)—(2) | (2)—(3) | (4)—(6) |
| S(3) (2) (1) (Bottom view) |  | 60T | 125T | 28T |
| No load Qu | | 40 | | |
| Tuning Capacitance | | 180pF | | |

• Matching of CERAFIL® SFPLA/CFULA/CFWLA series with IFT is decided by the Qu of IFT and IFT secondary side impedance, |Z2|. Set the Qu at about 40 because a Qu value which is too high (e.g., 90) may produce ripple in the waveform. It is recommended to match the impedance of |Z2| with that of the CERAFIL®.

■ Test Circuit

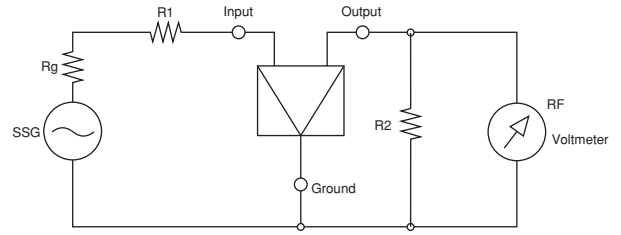

$R_g + R_1 = R_2$: Input/Output Impedance

■ Frequency Characteristics

IFT+SFPLA450KF1A-B0



IFT+CFWLA450KFFA-B0



IFT+CFULA450KF1Y-B0



IFT+CFWLA450KF1Y-B0

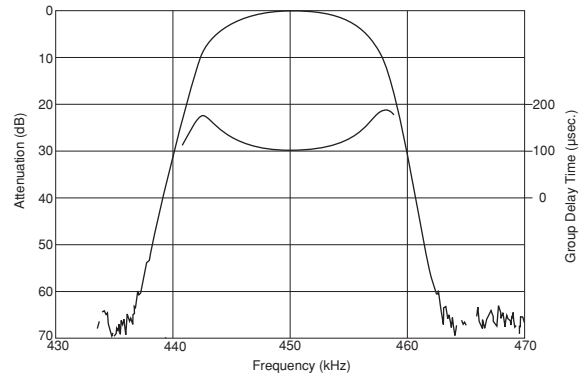

CERAFIL® 455kHz SF□ Series Temperature Characteristics

■ SFPLA450KH1A-B0



☐ Continued from the preceding page.

■ Frequency Characteristics

TPSKA6M00B00-R3



TPSKA6M50B00-R3



■ Frequency Characteristics (Spurious)

TPSKA4M50B00-R3

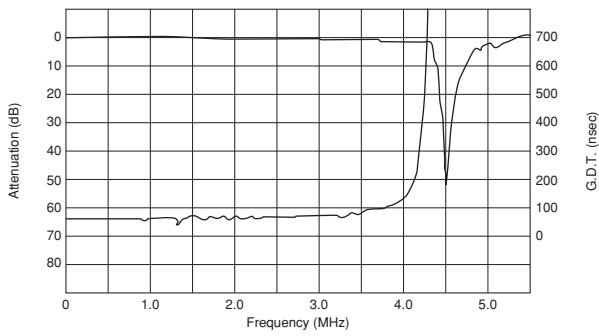

TPSKA5M50B00-R3

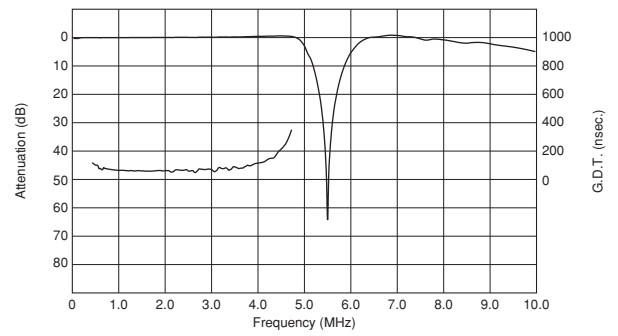

TPSKA6M00B00-R3

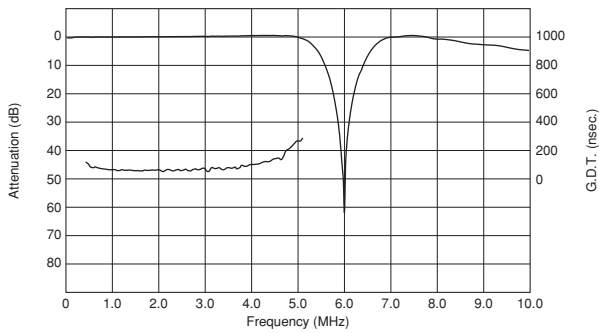

TPSKA6M50B00-R3

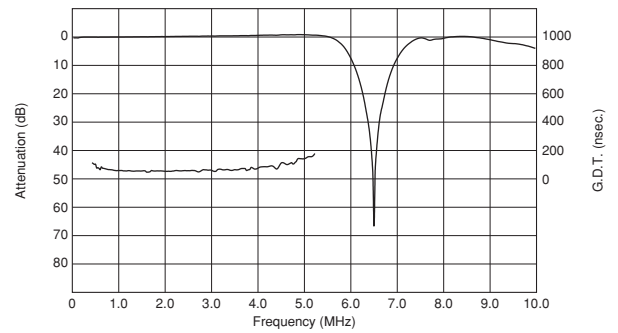

CERAFIL® (Ceramic Discriminator) for Audio/Visual Equipment



10.7MHz Ultra Thin Chip Type CDSCB Series

CDSCB10M7 series forms a resonator on a piezoelectric ceramic substrate. In combination with ICs, this type obtains stable demodulation characteristics in a wide bandwidth. They have 1.0mm max. thickness and small mounting area (4.5x2.0mm).

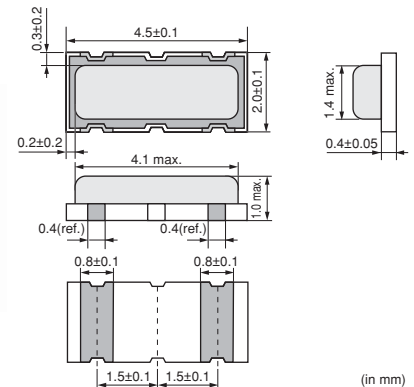

■ Features

1. Compact and high reliability and recommended for automotive applications.
2. Can be combined with various ICs. The IC is determined by the last number in the part number.
3. Stable demodulation characteristics can be obtained without adjustment.
4. Stable temperature characteristics.
5. Available lead (Pb) free solder reflow.

| Part Number | Center Frequency (fo) (MHz) | Recovered Audio 3dB BW (kHz) | Recovered Audio Output (mV) | Distortion (%) | S Curve (mV) | IC |
|--------------------|-----------------------------|------------------------------|-----------------------------|----------------|--------------|-----------|
| CDSCB10M7GA105A-R0 | 10.700 ±30kHz | 220 min. | 110 min. | 1.5 max. | - | TEA5757HL |
| CDSCB10M7GA113-R0 | 10.700 ±30kHz | 300 min. | 110 min. | 1.0 max. | - | TA2154FN |
| CDSCB10M7GA119-R0 | 10.700 ±30kHz | 500 min. | 75 min. | 1.0 max. | - | TRF6901 |
| CDSCB10M7GA121-R0 | 10.700 ±30kHz | 390 min. | 80 min. | 1.0 max. | - | LV23100V |
| CDSCB10M7GA135-R0 | 10.700 ±30kHz | 155 min. | 75 min. | - | - | TH71101 |
| CDSCB10M7GA136-R0 | 10.700 ±30kHz | 140 min. | 120 min. | - | - | TH7122 |
| CDSCB10M7GF072-R0 | 10.700 (fn) | fn±150 min. | 130 min. | 2.0 max. | - | TA31161 |
| CDSCB10M7GF107S-R0 | 10.700 (fn) | fn±80 min. | 52 min. | 3.0 max. | - | TA31272FN |
| CDSCB10M7GF109-R0 | 10.700 (fn) | fn±100 min. | 170 min. | 3.0 max. | - | TK14588V |
| CDSCB10M7GF123-R0 | 10.700 (fn) | - | - | - | 900 min. | TA31275FN |
| CDSCB10M7GF123S-R0 | 10.700 (fn) | - | - | - | 900 min. | TA31275FN |
| CDSCB10M7GF126-R0 | 10.700 (fn) | - | - | - | 400 min. | NJM2295AV |

(fn) means nominal center frequency (10.700MHz).

For safety purposes, avoid applying a direct current between the terminals.

The order quantity should be an integral multiple of the "Minimum Quantity" shown in the package page.

■ Standard Center Frequency Rank Code

| CODE | 30kHz Step | 25kHz Step |
|------|---------------------------|-----------------|
| D | 10.64MHz±30kHz | 10.650MHz±25kHz |
| B | 10.67MHz±30kHz | 10.675MHz±25kHz |
| A | 10.70MHz±30kHz | 10.700MHz±25kHz |
| C | 10.73MHz±30kHz | 10.725MHz±25kHz |
| E | 10.76MHz±30kHz | 10.750MHz±25kHz |
| Z | Combination A, B, C, D, E | |
| M | Combination A, B, C | |

Standard Land Pattern Dimensions



(in mm)

Test Circuit

CDSCB10M7GA105A-R0



CDSCB10M7GA113-R0



CDSCB10M7GA119-R0



CDSCB10M7GA121-R0



Continued on the following page.

■ Recovered Audio Curve

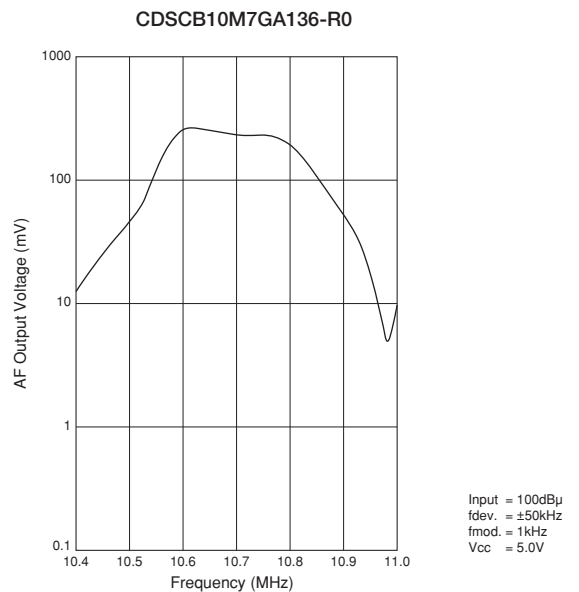
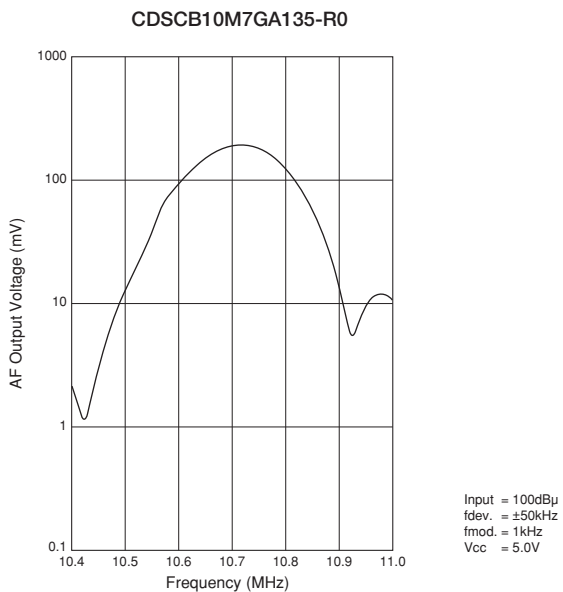

Continued on the following page. ↗

Continued from the preceding page.

■ Recovered Audio Curve



■ S Curve

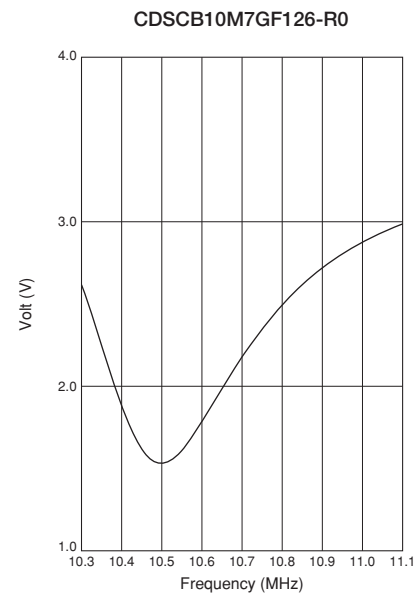
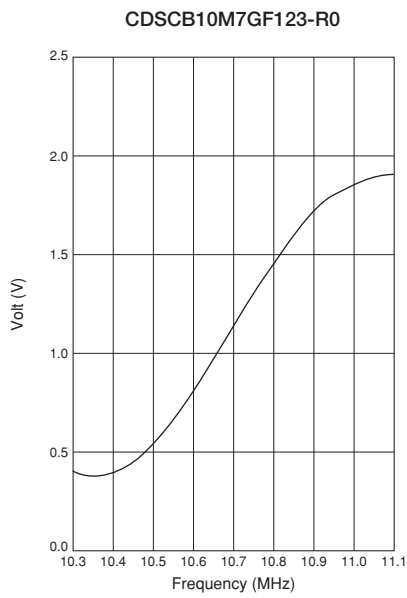

Ceramic Discriminator 10.7MHz Applied IC Reference Table

Please see the following table to reference applied IC.

If you cannot find the IC part number you are seeking, please contact our sales representative.

ex. : CDSCB10M7GA105A-R0

Suffix Number

| IC Manufacturer | IC Part Number | Suffix Number |
|-----------------|------------------|---------------|
| ATMEL | U4313B | 081 |
| | U4490B | 034V |
| INFINEON | TDA1576T | 051 |
| | TDA6160X | 038 |
| Panasonic | AN7004 | 011 |
| | AN7232 | 053 |
| Freescale | MC13156 | 049 |
| | MC13158 | 073 |
| Renesas | μPC1391M | 056 |
| NXP | NE604 | 020 |
| | SA605 | 042 |
| | SA626 | 047 |
| | SA636DK | 096 |
| | SA639 | 085 |
| | TDA1596T | 120 |
| | TEA5710 | 040 |
| | TEA5757HL | 105A |
| | TEA5762 / 5757 | 061 |
| | UAA3220TS | 098 |
| ROHM | BA1448 | 060 |
| | BA4230AF | 005 |
| | BA4234L | 004 |
| SAMSUNG | S1A0903 | 118A |
| SANYO | LA1225M | 108A |
| | LA1814M | 115 |
| | LA1823 | 101 |
| | LA1827M | 083 |
| | LA1831 | 043 |
| | LA1832 / M | 046 |
| | LA1833 | 086 |
| | LA1835 / M | 048 |
| | LA1838 / M | 079 |
| | LA7770 | 023 |
| | LV23000M | 114 |
| | LV23100V | 121 |
| SONY | CX1691M | 078 |
| | CX-20029 | 001 |
| | CXA1111 | 093 |
| | CXA1238 | 027 |
| | CXA1238N | 027N |
| | CX1343M | 032 |
| | CXA1376AM | 054 |
| | CXA1538M / N / S | 069 |
| | CXA1611 | 075 |
| | CX3067M | 076 |
| T. I. | TRF6901 | 119 |
| TOKO | TK14570L | 122 |
| | TK14583V | 112 |
| | TK14588V | 109 |

| IC Manufacturer | IC Part Number | Suffix Number |
|-----------------|------------------|---------------|
| TOSHIBA | TA2003 | 031 |
| | TA2007 | 033 |
| | TA2008A / AN | 045 |
| | TA2022 | 050 |
| | TA2057 | 057 |
| | TA2099N | 082 |
| | TA2104AFN | 080 |
| | TA2104F | 080A |
| | TA2111N / F / FN | 077 |
| | TA2132 | 092 |
| | TA2132BP | 092D |
| | TA2142FN | 102 |
| | TA2149AN | 100A |
| | TA2149N | 100 |
| | TA2154FN | 113 |
| | TA2159F | 116 |
| | TA31161 | 072 |
| | TA31275FN | 123 |
| | TA7303P | 008 |
| | TA7640AP | 006 |
| TA8122AN / AF | 016 | |
| TA8132AN / AF | 018 | |
| TB2132FN | 128 | |

Notice

■ CERAFIL® 10.7MHz Chip Type SFECF Series

● Soldering and Mounting

1. Standard Reflow Soldering Conditions

(1) Reflow

Filter is soldered twice within the following temperature conditions.



(2) Soldering Iron

Filter is soldered at $+350\pm 5^{\circ}\text{C}$ for 3.0 ± 0.5 seconds. The soldering iron should not touch the filter while soldering.

(3) Conditions for Placement Machines

The component is recommended for use with placement machines that employ optical placement capabilities. The component might be damaged by excessive mechanical force. Please make sure that you have evaluated by using placement machines before going into mass production. Do not use placement machines that utilize mechanical positioning. Please contact Murata for details beforehand.

(4) Other

- (a) The component may be damaged if excess mechanical stress is applied to it mounted on the printed circuit board.
- (b) Design layout of components on the PC board to minimize the stress imposed on the warp or flexure of the board.
- (c) After installing components, if solder is excessively applied to the circuit board, mechanical stress will cause destruction resistance characteristics to degrade. To prevent this, be extremely careful in determining shape and dimension before designing the circuit board diagram.
- (d) When the positioning claws and pick-up nozzle are worn, the load is applied to the components while positioning is concentrated on positioning accuracy, etc. Careful checking and maintenance are necessary to prevent unexpected trouble.
- (e) When correcting components with a soldering iron, the tip of the soldering iron should not directly touch the component. Depending on the soldering conditions, the effective area of terminations may be reduced. Solder containing Ag should be used to prevent electrode erosion.
- (f) Do not use strong acidity flux, more than 0.2wt% chlorine content, in reflow soldering.



Notice

☐ Continued from the preceding page.

2. Wash

Do not clean or wash the component as it is not hermetically sealed.

3. Coating

In case of overcoating the component, conditions such as material of resin, cure temperature, and so on should be evaluated well.

● Storage and Operating Conditions

1. Product Storage Conditions

Please store the products in a room where the temperature/humidity is stable, and avoid places where there are large temperature changes. Please store the products under the following conditions:

Temperature: -10 to +40°C

Humidity: 15 to 85% R.H.

2. Expiration Date on Storage

Expiration date (shelf life) of the products is six months after delivery under the conditions of a sealed and unopened package. Please use the products within six months after delivery. If you store the products for a long time (more than six months), use carefully because solderability may be degraded due to storage under poor conditions.

Please confirm solderability and characteristics for the products regularly.

3. Notice on Product Storage

(1) Please do not store the products in a chemical atmosphere (Acids, Alkali, Bases, Organic gas, Sulfides and so on), because quality and solderability may be degraded due to storage in a chemical atmosphere.

(2) Please do not put the products directly on the floor without anything under them to avoid damp places and/or dusty places.

(3) Please do not store the products in places such as a damp heated place or any place exposed to direct sunlight or excessive vibration.

(4) Please use the products immediately after package is opened, because quality and solderability may be degraded due to storage under poor conditions.

(5) To avoid cracking of ceramic element, please do not drop the products.

4. Other

Please be sure to consult with our sales representative or engineer whenever the products are to be used in conditions not listed above.

● Rating

The component may be damaged if excessive mechanical stress is applied.

● Handling

1. Accurate test circuit values are required to measure electrical characteristics. Miscorrelation may be caused if there is any deviation, especially stray capacitance, from the test circuit in the specification.

2. The components, packed in a moisture proof bag (dry pack), are sensitive to moisture. The following treatment is required before applying reflow soldering, to avoid reliability degradation caused by thermal stress. When unpacked, store the component in an atmosphere of reflow 30°C and below 60%R.H., and solder within 1 week.

3. For safety purposes, connect the output of filters to the IF amplifier through a D.C. blocking capacitor. Avoid applying a direct current to the output of ceramic filters.

Notice

■ CERAFIL® 10.7MHz Chip Type SFECV/SFECK Series

● Soldering and Mounting

1. Standard Reflow Soldering Conditions

(1) Reflow

Filter is soldered twice within the following temperature conditions.

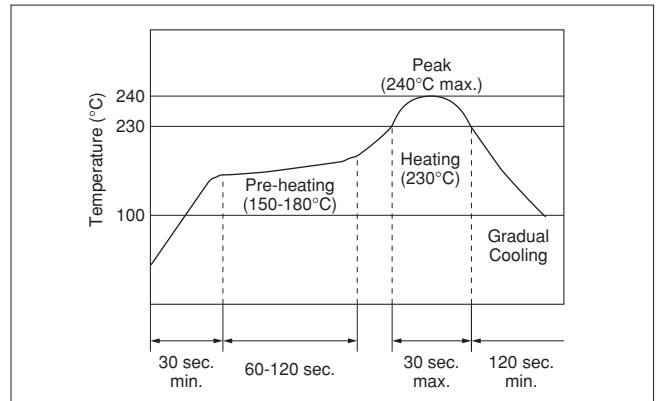

(2) Soldering Iron

Filter is soldered at $+350 \pm 5^\circ\text{C}$ for 3.0 ± 0.5 seconds. The soldering iron should not touch the filter while soldering.

(3) Conditions for Placement Machines

The component is recommended for use with placement machines that employ optical placement capabilities. Damage may result from excessive mechanical force. Please make sure that you have evaluated by using placement machines before going into mass production. Do not use placement machines that utilize mechanical positioning. Please contact Murata for details beforehand.

(4) Other

- (a) The component may be damaged if excess mechanical stress is applied to it mounted on the printed circuit board.
- (b) Design layout of components on the PC board to minimize the stress imposed on the warp or flexure of the board.
- (c) After installing components, if solder is excessively applied to the circuit board, mechanical stress will cause destruction resistance characteristics to degrade. To prevent this, be extremely careful in determining shape and dimension before designing the circuit board diagram.
- (d) When the positioning claws and pick-up nozzle are worn, the load is applied to the components while positioning is concentrated to one positioning accuracy, etc. Careful checking and maintenance are necessary to prevent unexpected trouble.
- (e) When correcting components with a soldering iron, the tip of the soldering iron should not directly touch the component. Depending on the soldering conditions, the effective area of terminations may be reduced. Solder containing Ag should be used to prevent electrode erosion.
- (f) Do not use strong acidity flux, more than 0.2wt% chlorine content, in reflow soldering.

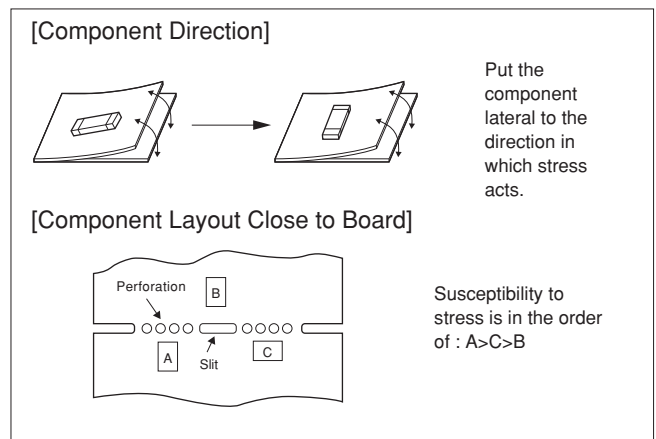

Continued on the following page. ↗

Notice

☐ Continued from the preceding page.

2. Wash

Do not clean or wash the component as it is not hermetically sealed.

3. Coating

In case of overcoating the component, conditions such as material of resin, cure temperature, and so on should be evaluated well.

● Storage and Operating Conditions

1. Product Storage Conditions

Please store the products in room where the temperature/humidity is stable, and avoid places where there are large temperature changes. Please store the products under the following conditions:

Temperature: -10 to +40°C

Humidity: 15 to 85% R.H.

2. Expiration Date on Storage

Expiration date (Shelf life) of the products is six months after delivery under the conditions of a sealed and unopened package. Please use the products within six months after delivery. If you store the products for a long time (more than six months), use carefully because the products may be degraded in solderability due to storage under poor conditions.

Please confirm solderability and characteristics for the products regularly.

3. Notice on Product Storage

(1) Please do not store the products in a chemical atmosphere (Acids, Alkali, Bases, Organic gas, Sulfides and so on), because quality and solderability may be degraded due to the storage in a chemical atmosphere.

- (2) Please do not put the products directly on the floor without anything under them to avoid damp places and/or dusty places.
- (3) Please do not store the products in the places such as a damp heated place or any place exposed to direct sunlight or excessive vibration.
- (4) Please use the products immediately after package is opened, because quality and solderability may be degraded due to storage under the poor conditions.
- (5) To avoid cracking of ceramic element, please do not drop the products.

4. Other

Please be sure to consult with our sales representative or engineer whenever the products are to be used in conditions not listed above.

● Rating

The component may be damaged if excessive mechanical stress is applied.

● Handling

1. Accurate test circuit values are required to measure electrical characteristics.

Miscorrelation may be caused if there is any deviation, especially stray capacitance, from the test circuit in the specification.

2. For safety purposes, connect the output of filters to the IF amplifier through a D.C. blocking capacitor. Avoid applying a direct current to the output of ceramic filters.

Notice

■ CERAFIL® 10.7MHz Lead Type SFELF Series

● Soldering and Mounting

The component cannot withstand washing.

● Storage and Operating Conditions

1. Product Storage Conditions

Please store the products in room where the temperature/humidity is stable, and avoid such places where there are large temperature changes. Please store the products under the following conditions:

Temperature: -10 to +40°C

Humidity: 15 to 85% R.H.

2. Expiration Date on Storage

Expiration date (Shelf life) of the products is six months after delivery under the conditions of a sealed and unopened package. Please use the products within six months after delivery. If you store the products for a long time (more than six months), use carefully because the products may be degraded in solderability due to storage under poor conditions.

Please confirm solderability and characteristics for the products regularly.

3. Notice on Product Storage

(1) Please do not store the products in a chemical atmosphere (Acids, Alkali, Bases, Organic gas, Sulfides and so on), because quality and solderability may be degraded due to the storage in a chemical atmosphere.

- (2) Please do not put the products directly on the floor without anything under them to avoid damp places and/or dusty places.
- (3) Please do not store the products in the places such as a damp heated place or any place exposed to direct sunlight or excessive vibration.
- (4) Please use the products immediately after package is opened, because quality and solderability may be degraded due to storage under the poor conditions.
- (5) To avoid cracking of ceramic element, please do not drop the products.

4. Other

Please be sure to consult with our sales representative or engineer whenever the products are to be used in conditions not listed above.

● Rating

The component may be damaged if excessive mechanical stress is applied.

● Handling

1. Do not use this product with bend. The component may be damaged if excess mechanical stress is applied to it mounted on the printed circuit board.
2. Do not apply any type of reflow soldering on the component.
3. Do not clean or wash the component as it is not hermetically sealed.
4. Do not use strong acidity flux, more than 0.2wt% chlorine content, in flow soldering.
5. In case of overcoating the component, conditions such as material of resin, cure temperature, and so on should be evaluated well.
6. Accurate test circuit values are required to measure electrical characteristics. It may be a cause of miscorrelation if there is any deviation, especially stray capacitance, from the test circuit in the specification.
7. For safety purposes, avoid applying a direct current between the terminals.

Notice

■ CERAFIL® 4.5-6.5MHz Chip Type SFSKA Series

● Soldering and Mounting

1. Standard Reflow Soldering Conditions

(1) Reflow

Filter is soldered twice within the following temperature conditions.



(2) Soldering Iron

Filter is soldered at $+350\pm 5^{\circ}\text{C}$ for 3.0 ± 0.5 seconds. The soldering iron should not touch the filter while soldering.

(3) Conditions for Placement Machines

The component is recommended for use with placement machines that employ optical placement capabilities. Damage may result from excessive mechanical force. Please make sure that you have evaluated by using placement machines before going into mass production. Do not use placement machines that utilize mechanical positioning. Please contact Murata for details beforehand.

(4) Other

- The component may be damaged if excess mechanical stress is applied to it mounted on the printed circuit board.
- Design layout of components on the PC board to minimize the stress imposed on the warp or flexure of the board.
- After installing chips, if solder is excessively applied to the circuit board, mechanical stress will cause destruction resistance characteristics to degrade. To prevent this, be extremely careful in determining shape and dimension before designing the circuit board diagram.
- When the positioning claws and pick-up nozzle are worn, the load is applied to the components while positioning is concentrated to one positioning accuracy, etc. Careful checking and maintenance are necessary to prevent unexpected trouble.
- When correcting chips with a soldering iron, the tip of the soldering iron should not directly touch the chip component.

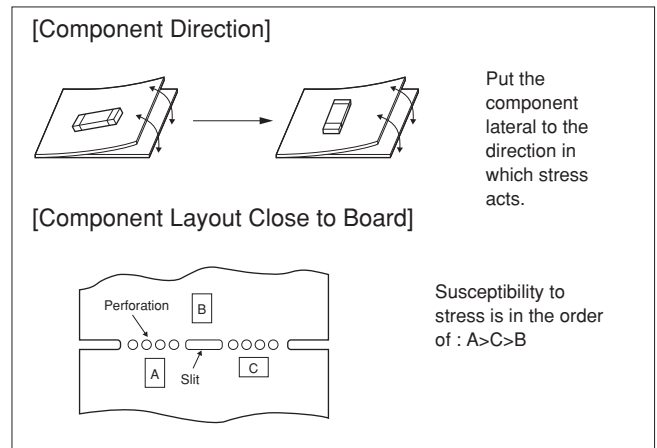

2. Wash

Do not clean or wash the component as it is not hermetically sealed.

Continued on the following page.

Notice

☐ Continued from the preceding page.

3. Coating

In case of overcoating the component, conditions such as material of resin, cure temperature, and so on should be evaluated well.

● Storage and Operating Conditions

1. Product Storage Conditions

Please store the products in room where the temperature/humidity is stable, and avoid places where there are large temperature changes. Please store the products under the following conditions:

Temperature: -10 to +40°C

Humidity: 15 to 85% R.H.

2. Expiration Date on Storage

Expiration date (Shelf life) of the products is six months after delivery under the conditions of a sealed and unopened package. Please use the products within six months after delivery. If you store the products for a long time (more than six months), use carefully because the products may be degraded in solderability due to storage under poor conditions.

Please confirm solderability and characteristics for the products regularly.

3. Notice on Product Storage

(1) Please do not store the products in a chemical atmosphere (Acids, Alkali, Bases, Organic gas, Sulfides and so on), because quality and solderability may be degraded due to the storage in a chemical atmosphere.

- (2) Please do not put the products directly on the floor without anything under them to avoid damp places and/or dusty places.
- (3) Please do not store the products in the places such as a damp heated place or any place exposed to direct sunlight or excessive vibration.
- (4) Please use the products immediately after package is opened, because quality and solderability may be degraded due to storage under the poor conditions.
- (5) To avoid cracking of ceramic element, please do not drop the products.

4. Other

Please be sure to consult with our sales representative or engineer whenever the products are to be used in conditions not listed above.

● Rating

The component may be damaged if excessive mechanical stress is applied.

● Handling

1. Accurate test circuit values are required to measure electrical characteristics.

Misrelation may be caused if there is any deviation, especially stray capacitance, from the test circuit in the specification.

2. For safety purposes, connect the output of filters to the IF amplifier through a D.C. blocking capacitor. Avoid applying a direct current to the output of ceramic filters.

Notice

■ CERAFIL® 2.3-5.7MHz Chip Type SFSKB Series

● Soldering and Mounting

1. Standard Reflow Soldering Conditions

(1) Reflow

Filter is soldered twice within the following temperature conditions.



(2) Soldering Iron

Filter is soldered at $+350\pm 5^{\circ}\text{C}$ for 3.0 ± 0.5 seconds. The soldering iron should not touch the filter while soldering.

(3) Conditions for Placement Machines

The component is recommended for use with placement machines that employ optical placement capabilities. Damage may result from excessive mechanical force. Please make sure that you have evaluated by using placement machines before going into mass production. Do not use placement machines that utilize mechanical positioning. Please contact Murata for details beforehand.

(4) Other

- The component may be damaged if excess mechanical stress is applied to it mounted on the printed circuit board.
- Design layout of components on the PC board to minimize the stress imposed on the warp or flexure of the board.
- After installing components, if solder is excessively applied to the circuit board, mechanical stress will cause destruction resistance characteristics to degrade. To prevent this, be extremely careful in determining shape and dimension before designing the circuit board diagram.
- When the positioning claws and pick-up nozzle are worn, the load is applied to the components while positioning is concentrated to one positioning accuracy, etc. Careful checking and maintenance are necessary to prevent unexpected trouble.
- When correcting components with a soldering iron, the tip of the soldering iron should not directly touch the component. Depending on the soldering conditions, the effective area of terminations may be reduced. Solder containing Ag should be used to prevent the electrode erosion.
- Do not use strong acidity flux, more than 0.2wt% chlorine content, in reflow soldering.



Continued on the following page. ↗

Notice

☐ Continued from the preceding page.

2. Wash

Do not clean or wash the component as it is not hermetically sealed.

3. Coating

In case of overcoating the component, conditions such as material of resin, cure temperature, and so on should be evaluated well.

● Storage and Operating Conditions

1. Product Storage Conditions

Please store the products in room where the temperature/humidity is stable, and avoid places where there are large temperature changes. Please store the products under the following conditions:

Temperature: -10 to +40°C

Humidity: 15 to 85% R.H.

2. Expiration Date on Storage

Expiration date (Shelf life) of the products is six months after delivery under the conditions of a sealed and unopened package. Please use the products within six months after delivery. If you store the products for a long time (more than six months), use carefully because the products may be degraded in solderability due to storage under poor conditions.

Please confirm solderability and characteristics for the products regularly.

3. Notice on Product Storage

(1) Please do not store the products in a chemical atmosphere (Acids, Alkali, Bases, Organic gas, Sulfides and so on), because quality and solderability may be degraded due to the storage in a chemical atmosphere.

- (2) Please do not put the products directly on the floor without anything under them to avoid damp places and/or dusty places.
- (3) Please do not store the products in the places such as a damp heated place or any place exposed to direct sunlight or excessive vibration.
- (4) Please use the products immediately after package is opened, because quality and solderability may be degraded due to storage under the poor conditions.
- (5) To avoid cracking of ceramic element, please do not drop the products.

4. Other

Please be sure to consult with our sales representative or engineer whenever the products are to be used in conditions not listed above.

● Rating

The component may be damaged if excessive mechanical stress is applied.

● Handling

1. Accurate test circuit values are required to measure electrical characteristics.

Miscorrelation may be caused if there is any deviation, especially stray capacitance, from the test circuit in the specification.

2. For safety purposes, connect the output of filters to the IF amplifier through a D.C. blocking capacitor. Avoid applying a direct current to the output of ceramic filters.

Notice

■ CERAFIL® 455kHz Chip Type SFPKA Series

● Soldering and Mounting

1. Standard Reflow Soldering Conditions

(1) Reflow

Filter is soldered twice within the following temperature conditions.

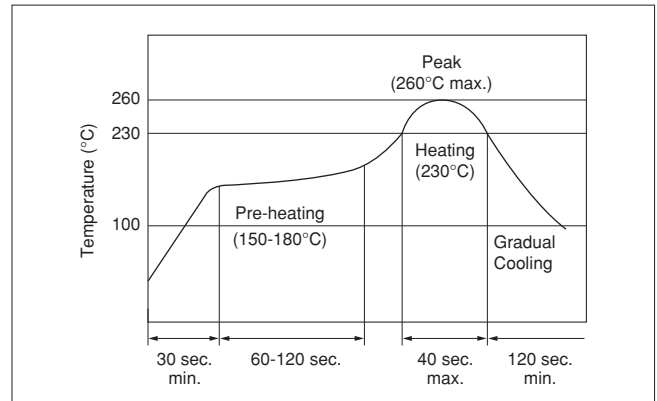

(2) Soldering Iron

Electrode is directly soldered with the tip of soldering iron at $+350\pm 5^{\circ}\text{C}$ for 3.0 ± 0.5 seconds.

(3) Other

Do not use strong acidity flux, more than 0.2wt% chlorine content, in reflow soldering.

2. Wash

(1) Cleaning Solvent

CFC alternatives (HCFC Series), Isopropyl Alcohol (IPA), Water (Demineralized Water), Cleaning Water Solution (Cleanthrough-750H, Pine Alpha 100S), Silicon (Technocare FRW)

(2) Cleaning Conditions

- Immersion Wash
2 minutes max. in above solvent at $+60^{\circ}\text{C}$ max.
- Shower or Rinse Wash
2 minutes max. in above solvent at $+60^{\circ}\text{C}$ max.

(3) Notice

- When components are immersed in solvent, be sure to maintain the temperature of components below the temperature of solvent.
- Please do not use ultrasonic cleaning.
- Total washing time should be 4 minutes maximum.
- Please ensure the component is thoroughly evaluated in your application circuit.
- Please do not use chlorine, petroleum or alkali cleaning solvent.
- If you plan to use any other types of solvents, please consult with Murata or a Murata representative prior to using.

3. Coating

In case of overcoating the component, conditions such as material of resin, cure temperature, and so on should be evaluated well.

Continued on the following page. 

Notice

☐ Continued from the preceding page.

● Storage and Operating Conditions

1. Product Storage Conditions

Please store the products in a room where the temperature/humidity is stable, and avoid places where there are large temperature changes. Please store the products under the following conditions:

Temperature: -10 to +40°C

Humidity: 15 to 85% R.H.

2. Expiration Date on Storage

Expiration date (shelf life) of the products is six months after delivery under the conditions of a sealed and unopened package. Please use the products within six months after delivery. If you store the products for a long time (more than six months), use carefully because solderability may be degraded due to storage under poor conditions.

Please confirm solderability and characteristics for the products regularly.

3. Notice on Product Storage

(1) Please do not store the products in a chemical atmosphere (Acids, Alkali, Bases, Organic gas, Sulfides and so on), because quality and solderability may be degraded due to storage in a chemical atmosphere.

● Rating

The component may be damaged if excessive mechanical stress is applied.

● Handling

1. If the component is cleaned, please confirm that the reliability has not been degraded.
2. The components, packed in a moisture-proof bag (dry pack), are sensitive to moisture. The following treatment is required before applying reflow soldering, to avoid package cracks or reliability degradation caused by thermal stress. When unpacked, store the component in an atmosphere of below 25°C and below 65%R.H., and solder within 48 hours.

(2) Please do not put the products directly on the floor without anything under them to avoid damp places and/or dusty places.

(3) Please do not store the products in places such as a damp heated place or any place exposed to direct sunlight or excessive vibration.

(4) Please use the products immediately after package is opened, because quality and solderability may be degraded due to storage under poor conditions.

(5) To avoid cracking of ceramic element, please do not drop the products.

4. Other

Please be sure to consult with our sales representative or engineer whenever the products are to be used in conditions not listed above.

3. For safety purposes, connect the output of filters to the IF amplifier through a D.C. blocking capacitor. Avoid applying a direct current to the output of ceramic filters.

Notice

■ CERAFIL® 455kHz Lead Type SFPLA/CFWLA/CFULA Series

● Soldering and Mounting

The component cannot withstand washing.

● Storage and Operating Conditions

1. Product Storage Conditions

Please store the products in a room where the temperature/humidity is stable, and avoid places where there are large temperature changes. Please store the products under the following conditions:

Temperature: -10 to +40°C

Humidity: 15 to 85% R.H.

2. Expiration Date on Storage

Expiration date (shelf life) of the products is six months after delivery under the conditions of a sealed and unopened package. Please use the products within six months after delivery. If you store the products for a long time (more than six months), use carefully because solderability may be degraded due to storage under poor conditions.

Please confirm solderability and characteristics for the products regularly.

3. Notice on Product Storage

(1) Please do not store the products in a chemical atmosphere (Acids, Alkali, Bases, Organic gas, Sulfides and so on), because quality and solderability may be degraded due to storage in a chemical atmosphere.

(2) Please do not put the products directly on the floor without anything under them to avoid damp places and/or dusty places.

(3) Please do not store the products in places such as a damp heated place or any place exposed to direct sunlight or excessive vibration.

(4) Please use the products immediately after package is opened, because quality and solderability may be degraded due to storage under poor conditions.

(5) To avoid cracking of ceramic element, please do not drop the products.

4. Other

Please be sure to consult with our sales representative or engineer whenever the products are to be used in conditions not listed above.

● Rating

The component may be damaged if excessive mechanical stress is applied.

● Handling

1. Do not use this product with bend. The component may be damaged if excessive mechanical stress is applied to it mounted on the printed circuit board.

2. All kinds of reflow soldering must not be applied on the component.

3. Do not clean or wash the component as it is not hermetically sealed.

4. Do not use strong acidity flux, more than 0.2wt% chlorine content, in flow soldering.

5. Conformal coating of the component is not acceptable due to non-sealed construction.

6. Accurate test circuit values are required to measure electrical characteristics. Misrelation may be caused if there is any deviation, especially stray capacitance, from the test circuit in the specification.

7. For safety purposes, connect the output of filters to the IF amplifier through a D.C. blocking capacitor. Avoid applying a direct current to the output of ceramic filters.

Notice

■ **Ceramic Trap 4.5-6.5MHz Chip Type TPSKA Series**

● **Soldering and Mounting**

1. **Standard Reflow Soldering Conditions**

(1) **Reflow**

Filter is soldered twice within the following temperature conditions.



(2) **Soldering Iron**

Filter is soldered at $+350\pm 5^{\circ}\text{C}$ for 3.0 ± 0.5 seconds. The soldering iron should not touch the filter while soldering.

(3) **Conditions for Placement Machines**

The component is recommended for use with placement machines that employ optical placement capabilities. Damage may result from excessive mechanical force. Please make sure that you have evaluated by using placement machines before going into mass production. Do not use placement machines that utilize mechanical positioning. Please contact Murata for details beforehand.

(4) **Other**

- (a) The component may be damaged if excess mechanical stress is applied to it mounted on the printed circuit board.
- (b) Design layout of components on the PC board to minimize the stress imposed on the warp or flexure of the board.
- (c) After installing chips, if solder is excessively applied to the circuit board, mechanical stress will cause destruction resistance characteristics to degrade. To prevent this, be extremely careful in determining shape and dimension before designing the circuit board diagram.
- (d) When the positioning claws and pick-up nozzle are worn, the load is applied to the components while positioning is concentrated to one positioning accuracy, etc. Careful checking and maintenance are necessary to prevent unexpected trouble.
- (e) When correcting chips with a soldering iron, the tip of the soldering iron should not directly touch the chip component.

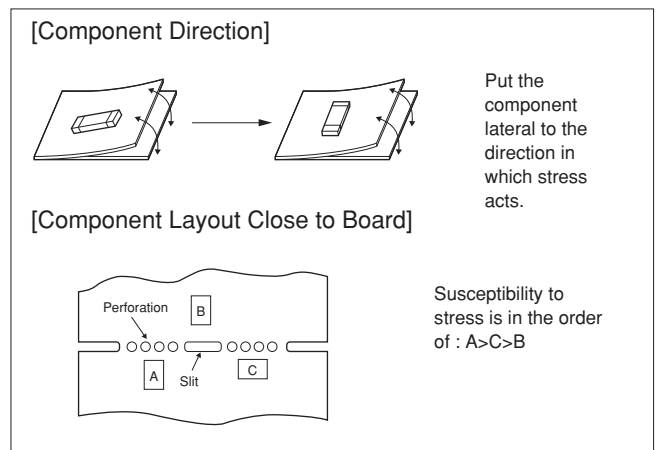

2. **Wash**

Do not clean or wash the component as it is not hermetically sealed.

Continued on the following page. ↗

Notice

☐ Continued from the preceding page.

3. Coating

In case of overcoating the component, conditions such as material of resin, cure temperature, and so on should be evaluated well.

● Storage and Operating Conditions

1. Product Storage Conditions

Please store the products in room where the temperature/humidity is stable, and avoid places where there are large temperature changes. Please store the products under the following conditions:

Temperature: -10 to +40°C

Humidity: 15 to 85% R.H.

2. Expiration Date on Storage

Expiration date (Shelf life) of the products is six months after delivery under the conditions of a sealed and unopened package. Please use the products within six months after delivery. If you store the products for a long time (more than six months), use carefully because the products may be degraded in solderability due to storage under poor conditions.

Please confirm solderability and characteristics for the products regularly.

3. Notice on Product Storage

(1) Please do not store the products in a chemical atmosphere (Acids, Alkali, Bases, Organic gas, Sulfides and so on), because quality and solderability may be degraded due to the storage in a chemical atmosphere.

- (2) Please do not put the products directly on the floor without anything under them to avoid damp places and/or dusty places.
- (3) Please do not store the products in the places such as a damp heated place or any place exposed to direct sunlight or excessive vibration.
- (4) Please use the products immediately after package is opened, because quality and solderability may be degraded due to storage under the poor conditions.
- (5) To avoid cracking of ceramic element, please do not drop the products.

4. Other

Please be sure to consult with our sales representative or engineer whenever the products are to be used in conditions not listed above.

● Rating

The component may be damaged if excessive mechanical stress is applied.

● Handling

1. Accurate test circuit values are required to measure electrical characteristics.

Miscorrelation may be caused if there is any deviation, especially stray capacitance, from the test circuit in the specification.

2. For safety purposes, connect the output of filters to the IF amplifier through a D.C. blocking capacitor. Avoid applying a direct current to the output of ceramic filters.

Notice

■ **Ceramic Discriminator 10.7MHz Chip Type CDSCB Series**

● **Soldering and Mounting**

1. **Standard Reflow Soldering Conditions**

(1) **Reflow**

Filter is soldered twice within the following temperature conditions.

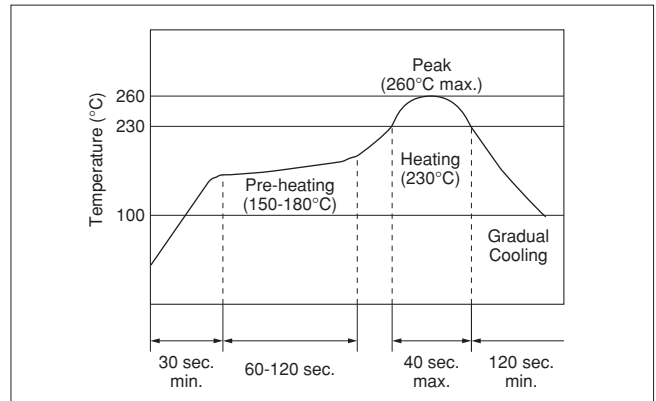

(2) **Soldering Iron**

Filter is soldered at $+300\pm 5^{\circ}\text{C}$ for 3.0 ± 0.5 seconds. The soldering iron should not touch the filter while soldering.

(3) **Conditions for Placement Machines**

The component is recommended for use with placement machines that employ optical placement capabilities. The component might be damaged by excessive mechanical force. Please make sure that you have evaluated by using placement machines before going into mass production. Do not use placement machines that utilize mechanical positioning. Please contact Murata for details beforehand.

(4) **Other**

- (a) The component may be damaged if excess mechanical stress is applied to it mounted on the printed circuit board.
- (b) Design layout of components on the PC board to minimize the stress imposed on the warp or flexure of the board.
- (c) After installing components, if solder is excessively applied to the circuit board, mechanical stress will cause destruction resistance characteristics to degrade. To prevent this, be extremely careful in determining shape and dimension before designing the circuit board diagram.
- (d) When the positioning claws and pick-up nozzle are worn, the load is applied to the components while positioning is concentrated on positioning accuracy, etc. Careful checking and maintenance are necessary to prevent unexpected trouble.
- (e) When correcting components with a soldering iron, the tip of the soldering iron should not directly touch the component. Depending on the soldering conditions, the effective area of terminations may be reduced. Solder containing Ag should be used to prevent electrode erosion.



Continued on the following page. ↗

Notice

☐ Continued from the preceding page.

2. Wash

Do not clean or wash the component as it is not hermetically sealed.

3. Coating

In case of overcoating the component, conditions such as material of resin, cure temperature, and so on should be evaluated well.

● Storage and Operating Conditions

1. Product Storage Conditions

Please store the products in a room where the temperature/humidity is stable, and avoid places where there are large temperature changes. Please store the products under the following conditions:

Temperature: -10 to +40°C

Humidity: 15 to 85% R.H.

2. Expiration Date on Storage

Expiration date (shelf life) of the products is six months after delivery under the conditions of a sealed and unopened package. Please use the products within six months after delivery. If you store the products for a long time (more than six months), use carefully because solderability may be degraded due to storage under poor conditions.

Please confirm solderability and characteristics for the products regularly.

3. Notice on Product Storage

(1) Please do not store the products in a chemical atmosphere (Acids, Alkali, Bases, Organic gas, Sulfides and so on), because quality and solderability may be degraded due to storage in a chemical atmosphere.

(2) Please do not put the products directly on the floor without anything under them to avoid damp places and/or dusty places.

(3) Please do not store the products in places such as a damp heated place or any place exposed to direct sunlight or excessive vibration.

(4) Please use the products immediately after package is opened, because quality and solderability may be degraded due to storage under poor conditions.

(5) To avoid cracking of ceramic element, please do not drop the products.

4. Other

Please be sure to consult with our sales representative or engineer whenever the products are to be used in conditions not listed above.

● Rating

The component may be damaged if excessive mechanical stress is applied.

● Handling

1. Accurate test circuit values are required to measure electrical characteristics. Miscorrelation may be caused if there is any deviation, especially stray capacitance, from the test circuit in the specification.

2. For safety purposes, avoid applying a direct current between the terminals.

Packaging

Minimum Quantity

| | Taping | | Ammo Pack | Bulk | Magazine | Box |
|---------------------------------|--------------|--------|-----------|------|----------|-----|
| | ø330mm | ø180mm | | | | |
| CERAFIL®<10.7MHz> | SFEFCF | | | | | |
| | SFEFCV/SFECK | | | | | |
| | SFELF | | 1,500 | 500 | | |
| CERAFIL®<2.3-6.5MHz> | SFSKA | 3,000 | | | | |
| | SFSKB | 3,000 | | | | |
| | | | | | | |
| CERAFIL®<455kHz> | CFULA | | | | | 200 |
| | CFWLA | 1,000 | | | 50 | 150 |
| | SFPLA | 1,000 | | | 50 | 200 |
| Ceramic Traps<4.5-6.5MHz> | | | | | | |
| | TPSKA | 3,000 | | | | |
| Ceramic Discriminators<10.7MHz> | | | | | | |
| | CDSCB | | 2,000 | | | |

CERAFIL® 10.7MHz Chip Type SFEFCF Series

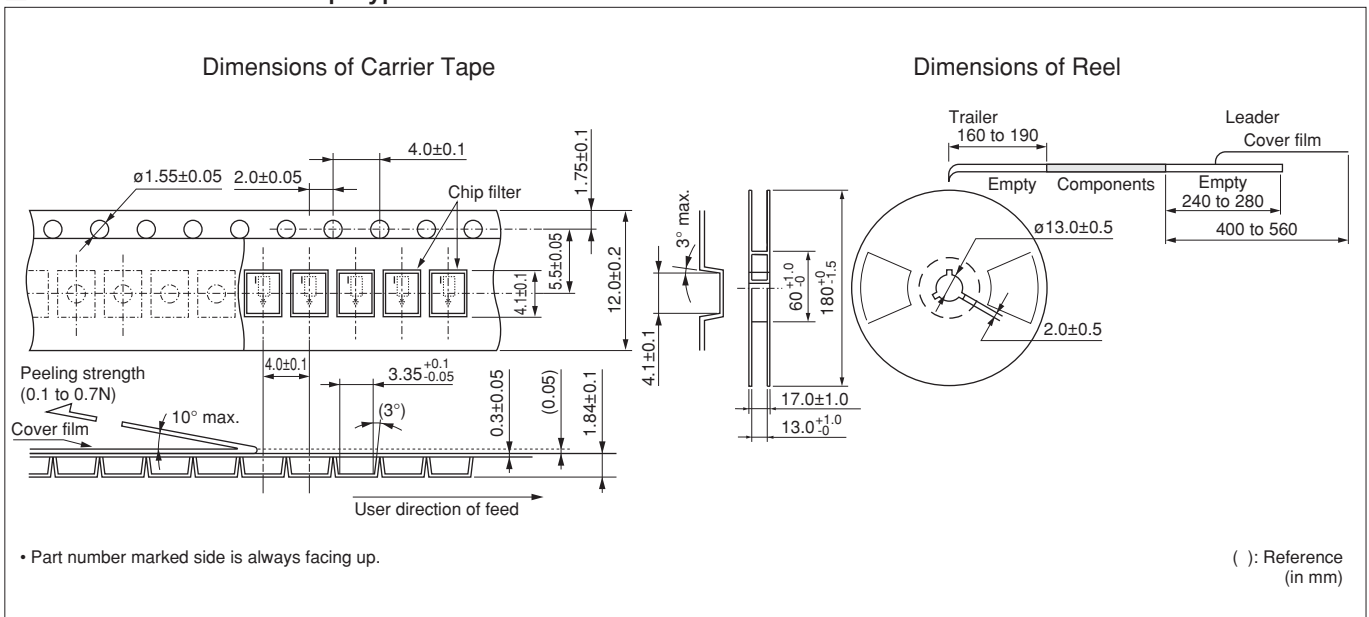

CERAFIL® 10.7MHz Chip Type SFEFCV/SFECK Series

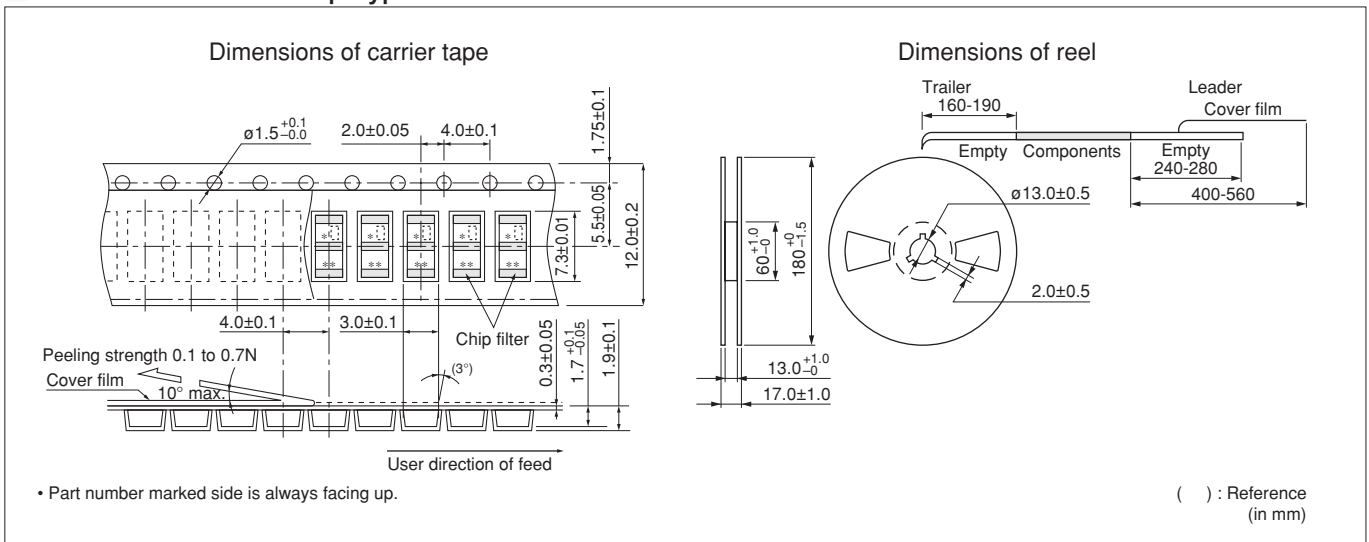

Continued on the following page. ↗

Packaging

Continued from the preceding page.

■ CERAFIL® 10.7MHz Lead Type SFELF Series

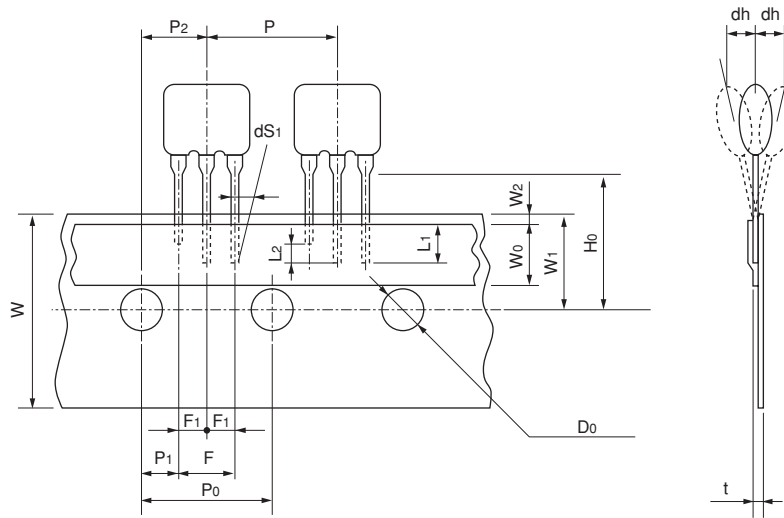

| Item | Code | Dimensions | Tolerance | Remarks |
|---|------|------------|--------------|--|
| Lead length under the hold down tape | L1 | 3.0 min. | - | |
| Length of cut-off | L2 | 2.0 max. | - | To distinguish the direction |
| Pitch of components | P | 12.7 | ±0.5 | |
| Pitch of sprocket hole (1) | P0 | 12.7 | ±0.2 | |
| Length from hole center to lead | P1 | 3.85 | ±0.5 | |
| Length from hole center to component center | P2 | 6.35 | ±0.5 | |
| Lead spacing (1) | F | 5.0 | +0.5 -0.2 | |
| Lead spacing (2) | F1 | 2.5 | ±0.2 | |
| Slant forward or backward | dh | 0 | ±1.0 | |
| Slant to the left or right | dS1 | 0 | ±1.0 | |
| Width of carrier tape | W | 18.0 | ±0.5 | |
| Width of hold down tape | W0 | 6.0 min. | - | |
| Position of sprocket hole | W1 | 9.0 | ±0.5 | |
| Gap of hold down tape and carrier tape | W2 | 0 | +0.5 -0 | Hold down tape doesn't exceed the carrier tape |
| Distance between the center of sprocket hole and lead stopper | Ho | 18.0 | ±0.5 | |
| Diameter of sprocket hole | Do | ø4.0 | ±0.2 | |
| Total tape thickness | t | 0.6 | ±0.2 | |
| Pitch of sprocket hole (2) | P020 | 254.0 | ±1.5 | The pitch of 20 sprocket holes |

(in mm)

Continued on the following page.

Packaging

☐ Continued from the preceding page.

■ CERAFIL® 4.5-6.5MHz Chip Type SFSKA Series



■ CERAFIL® 2.3-5.7MHz Chip Type SFSKB Series

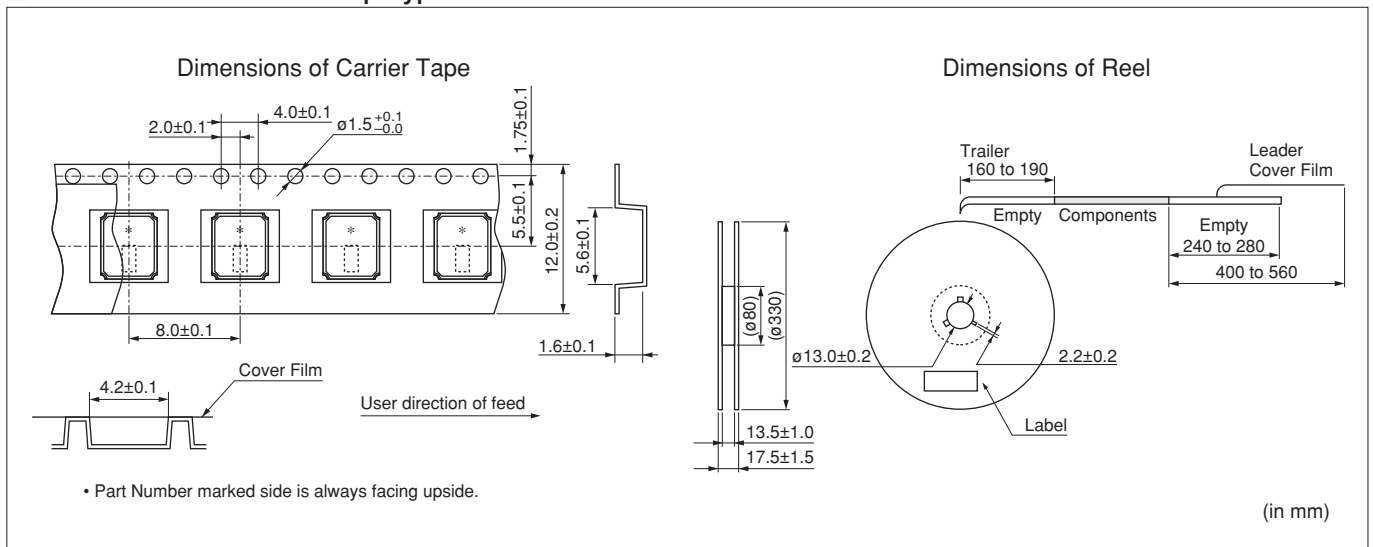

■ CERAFIL® 455kHz Chip Type SFPKA Series

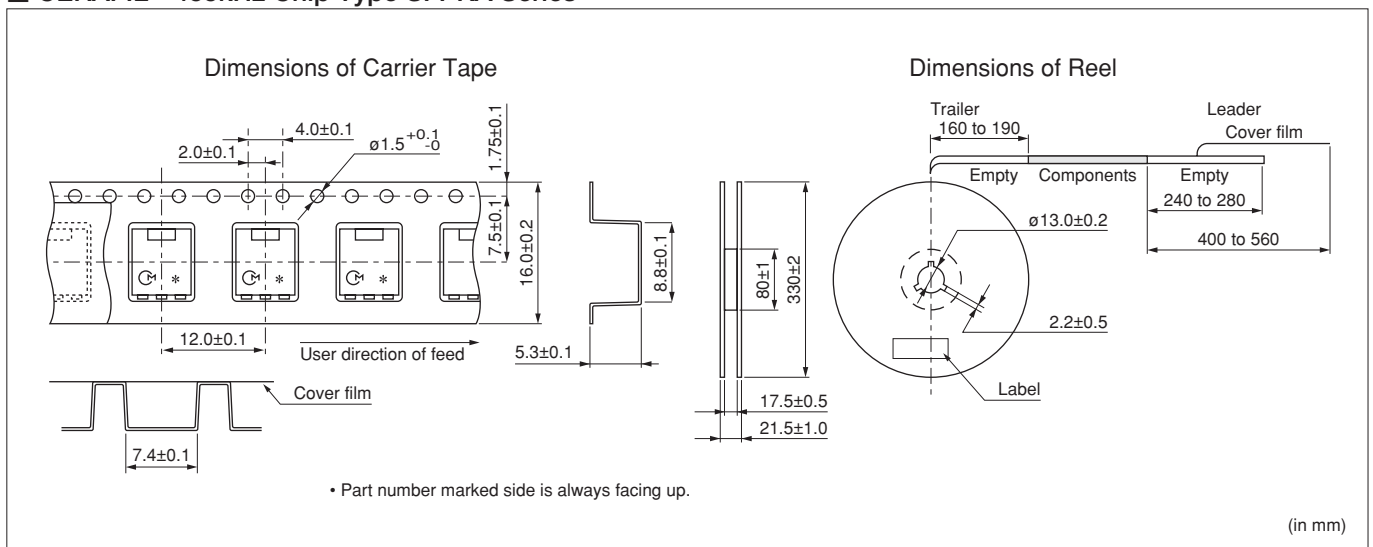

Continued on the following page. ☐

Packaging

☐ Continued from the preceding page.

■ CERAFIL® 455kHz Lead Type SFPLA Series

Standard of Magazine Cassette

1. Putting CERAFIL® into Magazine

A magazine should contain 50pcs of CERAFIL®, with ground terminals all facing toward the "Murata" mark on a magazine, and be closed with exclusive stoppers at both ends. Above should be the minimum packaging unit.

2. Quality of Magazine

- (1) Transparent so that input / output direction is visually recognizable.
- (2) With an angle of 35° CERAFIL® should slip down smoothly.
- (3) Antistatic finish
- (4) Recycling

Note: Magazines should be sent back for recycling.
 (Therefore, empty magazines should not be damaged.)

3. Dimensions of Magazine Cassette



■ CERAFIL® 455kHz Lead Type CFWLA Series

Standard of Magazine Cassette

1. Putting CERAFIL® into Magazine

A magazine should contain 50pcs of CERAFIL®, with ground terminals all facing toward the "Murata" mark on a magazine, and be closed with exclusive stoppers at both ends. Above should be the minimum packaging unit.

2. Quality of Magazine

- (1) Transparent so that input / output direction is visually recognizable.
- (2) With an angle of 35° CERAFIL® should slip down smoothly.
- (3) Antistatic finish
- (4) Recycling

Note: Magazines should be sent back for recycling.
 (Therefore, empty magazines should not be damaged.)

4. Dimensions of Magazine Cassette



3. Magazine should be packaged in a cardboard box.
 MURATA model name, quantity and outgoing inspection number should be indicated on the box.
 Cardboard box may contain maximum 33 magazines
 (1,650 pieces of filter).

Continued on the following page. ☐

Packaging

Continued from the preceding page.

■ Ceramic Trap 4.5-6.5MHz Chip Type TPSKA Series



■ Ceramic Discriminator 10.7MHz Chip Type CDSCB Series



Part Number Index

| | | |
|--------------|--|----------------------------|
| CDSCB | Chip Ceramic Discriminators for FM | p47 |
| CFULA | Ceramic Filters (CERAFIL®) for AM | p42 |
| CFWLA | Ceramic Filters (CERAFIL®) for AM | p40, 42 |
| SFECF | Chip Ceramic Filters (CERAFIL®) for FM | p5-6 |
| SFECK | Chip Ceramic Filters (CERAFIL®) for FM | p11 |
| SFECV | Chip Ceramic Filters (CERAFIL®) for FM | p11 |
| SFELF | Ceramic Filters (CERAFIL®) for FM | p14, 17, 20-21, 23, 25, 27 |
| SFPKA | Chip Ceramic Filters (CERAFIL®) for AM | p38 |
| SFPLA | Ceramic Filters (CERAFIL®) for AM | p40, 42 |
| SFSKA | Chip Ceramic Filters (CERAFIL®) for TV/VCR | p31 |
| SFSKB | Chip Ceramic Filters (CERAFIL®) for TV/VCR | p34 |
| TPSKA | Chip Ceramic Traps | p45 |

⚠Note:

1. Export Control

<For customers outside Japan>

No Murata products should be used or sold, through any channels, for use in the design, development, production, utilization, maintenance or operation of, or otherwise contribution to (1) any weapons (Weapons of Mass Destruction [nuclear, chemical or biological weapons or missiles] or conventional weapons) or (2) goods or systems specially designed or intended for military end-use or utilization by military end-users.

<For customers in Japan>

For products which are controlled items subject to the "Foreign Exchange and Foreign Trade Law" of Japan, the export license specified by the law is required for export.

2. Please contact our sales representatives or product engineers before using the products in this catalog for the applications listed below, which require especially high reliability for the prevention of defects which might directly damage a third party's life, body or property, or when one of our products is intended for use in applications other than those specified in this catalog.

- | | |
|-----------------------------|--|
| ① Aircraft equipment | ② Aerospace equipment |
| ③ Undersea equipment | ④ Power plant equipment |
| ⑤ Medical equipment | ⑥ Transportation equipment (vehicles, trains, ships, etc.) |
| ⑦ Traffic signal equipment | ⑧ Disaster prevention / crime prevention equipment |
| ⑨ Data-processing equipment | ⑩ Application of similar complexity and/or reliability requirements to the applications listed above |

3. Product specifications in this catalog are as of July 2012. They are subject to change or our products in it may be discontinued without advance notice. Please check with our sales representatives or product engineers before ordering. If there are any questions, please contact our sales representatives or product engineers.
4. Please read rating and ⚠CAUTION (for storage, operating, rating, soldering, mounting and handling) in this catalog to prevent smoking and/or burning, etc.
5. This catalog has only typical specifications. Therefore, please approve our product specifications or transact the approval sheet for product specifications before ordering.
6. Please note that unless otherwise specified, we shall assume no responsibility whatsoever for any conflict or dispute that may occur in connection with the effect of our and/or a third party's intellectual property rights and other related rights in consideration of your use of our products and/or information described or contained in our catalogs. In this connection, no representation shall be made to the effect that any third parties are authorized to use the rights mentioned above under licenses without our consent.
7. No ozone depleting substances (ODS) under the Montreal Protocol are used in our manufacturing process.

Компания «Океан Электроники» предлагает заключение долгосрочных отношений при поставках импортных электронных компонентов на взаимовыгодных условиях!

Наши преимущества:

- Поставка оригинальных импортных электронных компонентов напрямую с производств Америки, Европы и Азии, а так же с крупнейших складов мира;
- Широкая линейка поставок активных и пассивных импортных электронных компонентов (более 30 млн. наименований);
- Поставка сложных, дефицитных, либо снятых с производства позиций;
- Оперативные сроки поставки под заказ (от 5 рабочих дней);
- Экспресс доставка в любую точку России;
- Помощь Конструкторского Отдела и консультации квалифицированных инженеров;
- Техническая поддержка проекта, помощь в подборе аналогов, поставка прототипов;
- Поставка электронных компонентов под контролем ВП;
- Система менеджмента качества сертифицирована по Международному стандарту ISO 9001;
- При необходимости вся продукция военного и аэрокосмического назначения проходит испытания и сертификацию в лаборатории (по согласованию с заказчиком);
- Поставка специализированных компонентов военного и аэрокосмического уровня качества (Xilinx, Altera, Analog Devices, Intersil, Interpoint, Microsemi, Actel, Aeroflex, Peregrine, VPT, Syfer, Eurofarad, Texas Instruments, MS Kennedy, Miteq, Cobham, E2V, MA-COM, Hittite, Mini-Circuits, General Dynamics и др.);

Компания «Океан Электроники» является официальным дистрибьютором и эксклюзивным представителем в России одного из крупнейших производителей разъемов военного и аэрокосмического назначения «JONHON», а так же официальным дистрибьютором и эксклюзивным представителем в России производителя высокотехнологичных и надежных решений для передачи СВЧ сигналов «FORSTAR».



JONHON

«JONHON» (основан в 1970 г.)

Разъемы специального, военного и аэрокосмического назначения:

(Применяются в военной, авиационной, аэрокосмической, морской, железнодорожной, горно- и нефтедобывающей отраслях промышленности)

«FORSTAR» (основан в 1998 г.)

ВЧ соединители, коаксиальные кабели, кабельные сборки и микроволновые компоненты:

(Применяются в телекоммуникациях гражданского и специального назначения, в средствах связи, РЛС, а так же военной, авиационной и аэрокосмической отраслях промышленности).



Телефон: 8 (812) 309-75-97 (многоканальный)

Факс: 8 (812) 320-03-32

Электронная почта: ocean@oceanchips.ru

Web: <http://oceanchips.ru/>

Адрес: 198099, г. Санкт-Петербург, ул. Калинина, д. 2, корп. 4, лит. А