

## FEATURES

Multipoint LVDS transceivers (low voltage differential signaling driver and receiver pairs)

Switching rate: 100 Mbps (50 MHz)

Supported bus loads: 30  $\Omega$  to 55  $\Omega$

Choice of 2 receiver types

Type 1 (ADN4690E/ADN4692E): hysteresis of 25 mV

Type 2 (ADN4694E/ADN4695E): threshold offset of 100 mV for open-circuit and bus-idle fail-safe

Conforms to TIA/EIA-899 standard for M-LVDS

Glitch-free power-up/power-down on M-LVDS bus

Controlled transition times on driver output

Common-mode range:  $-1$  V to  $+3.4$  V, allowing communication with 2 V of ground noise

Driver outputs high-Z when disabled or powered off

Enhanced ESD protection on bus pins

$\pm 15$  kV HBM (human body model), air discharge

$\pm 8$  kV HBM (human body model), contact discharge

$\pm 10$  kV IEC 61000-4-2, air discharge

$\pm 8$  kV IEC 61000-4-2, contact discharge

Operating temperature range:  $-40^{\circ}\text{C}$  to  $+85^{\circ}\text{C}$

Available in 8-lead (ADN4690E/ADN4694E) and 14-lead (ADN4692E/ADN4695E) SOIC packages

## APPLICATIONS

Backplane and cable multipoint data transmission

Multipoint clock distribution

Low power, high speed alternative to shorter RS-485 links

Networking and wireless base station infrastructure

## GENERAL DESCRIPTION

The ADN4690E/ADN4692E/ADN4694E/ADN4695E are multipoint, low voltage differential signaling (M-LVDS) transceivers (driver and receiver pairs) that can operate at up to 100 Mbps (50 MHz). Slew rate control is implemented on the driver outputs. The receivers detect the bus state with a differential input of as little as 50 mV over a common-mode voltage range of  $-1$  V to  $+3.4$  V. ESD protection of up to  $\pm 15$  kV is implemented on the bus pins. The parts adhere to the TIA/EIA-899 standard for M-LVDS and complement TIA/EIA-644 LVDS devices with additional multipoint capabilities.

The ADN4690E/ADN4692E are Type 1 receivers with 25 mV of hysteresis, so that slow-changing signals or loss of input does not lead to output oscillations. The ADN4694E/ADN4695E are Type 2 receivers exhibiting an offset threshold, guaranteeing the output state when the bus is idle (bus-idle fail-safe) or the inputs are open (open-circuit fail-safe).

Rev. B

[Document Feedback](#)

Information furnished by Analog Devices is believed to be accurate and reliable. However, no responsibility is assumed by Analog Devices for its use, nor for any infringements of patents or other rights of third parties that may result from its use. Specifications subject to change without notice. No license is granted by implication or otherwise under any patent or patent rights of Analog Devices. Trademarks and registered trademarks are the property of their respective owners.

## FUNCTIONAL BLOCK DIAGRAMS



Figure 1.



Figure 2.

The parts are available as half-duplex in an 8-lead SOIC package (the ADN4690E/ADN4694E) or as full-duplex in a 14-lead SOIC package (the ADN4692E/ADN4695E). A selection table for the ADN469xE parts is shown in Table 1.

Table 1. High Speed M-LVDS Transceiver Selection Table

Part No.	Receiver	Data Rate	SOIC	Duplex
<a href="#">ADN4690E</a>	Type 1	100 Mbps	8-lead	Half
<a href="#">ADN4691E</a>	Type 1	200 Mbps	8-lead	Half
<a href="#">ADN4692E</a>	Type 1	100 Mbps	14-lead	Full
<a href="#">ADN4693E</a>	Type 1	200 Mbps	14-lead	Full
<a href="#">ADN4694E</a>	Type 2	100 Mbps	8-lead	Half
<a href="#">ADN4695E</a>	Type 2	100 Mbps	14-lead	Full
<a href="#">ADN4696E</a>	Type 2	200 Mbps	8-lead	Half
<a href="#">ADN4697E</a>	Type 2	200 Mbps	14-lead	Full

## TABLE OF CONTENTS

Features .....	1	Driver Voltage and Current Measurements.....	11
Applications.....	1	Driver Timing Measurements .....	12
Functional Block Diagrams.....	1	Receiver Timing Measurements.....	13
General Description .....	1	Theory of Operation .....	14
Revision History .....	2	Half-Duplex/Full-Duplex Operation.....	14
Specifications.....	3	Three-State Bus Connection.....	14
Receiver Input Threshold Test Voltages .....	4	Truth Tables.....	14
Timing Specifications .....	5	Glitch-Free Power-Up/Power-Down .....	15
Absolute Maximum Ratings.....	6	Fault Conditions .....	15
Thermal Resistance .....	6	Receiver Input Thresholds/Fail-Safe.....	15
ESD Caution.....	6	Applications Information .....	16
Pin Configurations and Function Descriptions .....	7	Outline Dimensions .....	17
Typical Performance Characteristics .....	8	Ordering Guide .....	17
Test Circuits and Switching Characteristics.....	11		

## REVISION HISTORY

### 1/16—Rev. A to Rev. B

Changed NC to DNC.....	Throughout
Changes to Table 1 Title.....	1
Changes to Table 6.....	6

### 3/12—Rev. 0 to Rev. A

Added ADN4694E and ADN4695E.....	Universal
Change to Features Section, General Description Section, and Table 1.....	1
Added Type 2 Receiver Parameters, Table 2 .....	3

Added Table 4, Renumbered Sequentially .....	5
Added Type 2 Receiver Parameters, Table 5 .....	5
Changes to Table 8.....	7
Added Table 13 .....	14
Changes to Receiver Input Thresholds/Fail-Safe Section and Figure 35.....	15
Changes to Figure 36 and Figure 37 and Their Captions .....	16
Changes to Ordering Guide .....	18

### 1/12—Revision 0: Initial Version

## SPECIFICATIONS

$V_{CC} = 3.0\text{ V to }3.6\text{ V}$ ;  $R_L = 50\ \Omega$ ;  $T_A = T_{MIN}$  to  $T_{MAX}$ , unless otherwise noted.<sup>1</sup>

Table 2.

Parameter	Symbol	Min	Typ	Max	Unit	Test Conditions/Comments
<b>DRIVER</b>						
Differential Outputs						
Differential Output Voltage Magnitude	$ V_{OD} $	480		650	mV	See Figure 18
$\Delta V_{OD} $ for Complementary Output States	$\Delta V_{OD} $	-50		+50	mV	See Figure 18
Common-Mode Output Voltage (Steady State)	$V_{OC(SS)}$	0.8		1.2	V	See Figure 19, Figure 22
$\Delta V_{OC(SS)}$ for Complementary Output States	$\Delta V_{OC(SS)}$	-50		+50	mV	See Figure 19, Figure 22
Peak-to-Peak $V_{OC}$	$V_{OC(PP)}$			150	mV	See Figure 19, Figure 22
Maximum Steady-State Open-Circuit Output Voltage	$V_{A(O)}$ , $V_{B(O)}$ , $V_{Y(O)}$ or $V_{Z(O)}$	0		2.4	V	See Figure 20
Voltage Overshoot						
Low to High	$V_{PH}$			$1.2V_{SS}$	V	See Figure 23, Figure 26
High to Low	$V_{PL}$	$-0.2V_{SS}$			V	See Figure 23, Figure 26
Output Current						
Short Circuit	$ I_{OS} $			24	mA	See Figure 21
High Impedance State, Driver Only	$I_{OZ}$	-15		+10	$\mu\text{A}$	$-1.4\text{ V} \leq (V_Y \text{ or } V_Z) \leq 3.8\text{ V}$ , other output = 1.2 V
Power Off	$I_{O(OFF)}$	-10		+10	$\mu\text{A}$	$-1.4\text{ V} \leq (V_Y \text{ or } V_Z) \leq 3.8\text{ V}$ , other output = 1.2 V, $0\text{ V} \leq V_{CC} \leq 1.5\text{ V}$
Output Capacitance						
Differential Output Capacitance	$C_{YZ}$		3	2.5	pF	$V_I = 0.4 \sin(30e^6\pi t)\text{ V} + 0.5\text{ V}$ , <sup>2</sup> other output = 1.2 V, DE = 0 V
Output Capacitance Balance ( $C_Y/C_Z$ )	$C_{Y/Z}$	0.99		1.01		$V_{AB} = 0.4 \sin(30e^6\pi t)\text{ V}$ , <sup>2</sup> DE = 0 V
Logic Inputs (DI, DE)						
Input High Voltage	$V_{IH}$	2		$V_{CC}$	V	
Input Low Voltage	$V_{IL}$	GND		0.8	V	
Input High Current	$I_{IH}$	0		10	$\mu\text{A}$	$V_{IH} = 2\text{ V to }V_{CC}$
Input Low Current	$I_{IL}$	0		10	$\mu\text{A}$	$V_{IL} = \text{GND to }0.8\text{ V}$
<b>RECEIVER</b>						
Differential Inputs						
Differential Input Threshold Voltage						
Type 1 Receiver (ADN4690E, ADN4692E)	$V_{TH}$	-50		+50	mV	See Table 3, Figure 35
Type 2 Receiver (ADN4694E, ADN4695E)	$V_{TH}$	50		150	mV	See Table 4, Figure 35
Input Hysteresis						
Type 1 Receiver (ADN4690E, ADN4692E)	$V_{HYS}$		25		mV	
Type 2 Receiver (ADN4694E, ADN4695E)	$V_{HYS}$		0		mV	
Differential Input Voltage Magnitude	$ V_{ID} $	0.05		$V_{CC}$	V	
Input Capacitance						
Differential Input Capacitance	$C_{AB}$			2.5	pF	$V_I = 0.4 \sin(30e^6\pi t)\text{ V} + 0.5\text{ V}$ , <sup>2</sup> other input = 1.2 V
Input Capacitance Balance ( $C_A/C_B$ )	$C_{A/B}$	0.99		1.01		$V_{AB} = 0.4 \sin(30e^6\pi t)\text{ V}$ , <sup>2</sup>
Logic Output RO						
Output High Voltage	$V_{OH}$	2.4			V	$I_{OH} = -8\text{ mA}$
Output Low Voltage	$V_{OL}$			0.4	V	$I_{OL} = 8\text{ mA}$
High Impedance Output Current	$I_{OZ}$	-10		+15	$\mu\text{A}$	$V_O = 0\text{ V or }3.6\text{ V}$
Logic Input RE						
Input High Voltage	$V_{IH}$	2		$V_{CC}$	V	
Input Low Voltage	$V_{IL}$	GND		0.8	V	
Input High Current	$I_{IH}$	-10		0	$\mu\text{A}$	$V_{IH} = 2\text{ V to }V_{CC}$
Input Low Current	$I_{IL}$	-10		0	$\mu\text{A}$	$V_{IL} = \text{GND to }0.8\text{ V}$

Parameter	Symbol	Min	Typ	Max	Unit	Test Conditions/Comments
<b>BUS INPUT/OUTPUT</b>						
Input Current						
A (Receiver or Transceiver with Driver Disabled)	$I_A$	0		32	$\mu\text{A}$	$V_B = 1.2\text{ V}, V_A = 3.8\text{ V}$
		-20		+20	$\mu\text{A}$	$V_B = 1.2\text{ V}, V_A = 0\text{ V or } 2.4\text{ V}$
		-32		0	$\mu\text{A}$	$V_B = 1.2\text{ V}, V_A = -1.4\text{ V}$
B (Receiver or Transceiver with Driver Disabled)	$I_B$	0		32	$\mu\text{A}$	$V_A = 1.2\text{ V}, V_B = 3.8\text{ V}$
		-20		+20	$\mu\text{A}$	$V_A = 1.2\text{ V}, V_B = 0\text{ V or } 2.4\text{ V}$
		-32		0	$\mu\text{A}$	$V_A = 1.2\text{ V}, V_B = -1.4\text{ V}$
Differential (Receiver or Transceiver with Driver Disabled)	$I_{AB}$	-4		+4	$\mu\text{A}$	$V_A = V_B, 1.4\text{ V} \leq V_A \leq 3.8\text{ V}$
Power-Off Input Current						
A (Receiver or Transceiver)	$I_{A(\text{OFF})}$	0		32	$\mu\text{A}$	$0\text{ V} \leq V_{CC} \leq 1.5\text{ V}$ $V_B = 1.2\text{ V}, V_A = 3.8\text{ V}$
		-20		+20	$\mu\text{A}$	$V_B = 1.2\text{ V}, V_A = 0\text{ V or } 2.4\text{ V}$
		-32		0	$\mu\text{A}$	$V_B = 1.2\text{ V}, V_A = -1.4\text{ V}$
B (Receiver or Transceiver)	$I_{B(\text{OFF})}$	0		32	$\mu\text{A}$	$V_A = 1.2\text{ V}, V_B = 3.8\text{ V}$
		-20		+20	$\mu\text{A}$	$V_A = 1.2\text{ V}, V_B = 0\text{ V or } 2.4\text{ V}$
		-32		0	$\mu\text{A}$	$V_A = 1.2\text{ V}, V_B = -1.4\text{ V}$
Differential (Receiver or Transceiver)	$I_{AB(\text{OFF})}$	-4		+4	$\mu\text{A}$	$V_A = V_B, 1.4\text{ V} \leq V_A \leq 3.8\text{ V}$
Input Capacitance (Transceiver with Driver Disabled)	$C_A$ or $C_B$		5		pF	$V_I = 0.4 \sin(30e^6\pi t)\text{ V} + 0.5\text{ V},^2$ other input = 1.2 V, DE = 0 V
Differential Input Capacitance (Transceiver with Driver Disabled)	$C_{AB}$			3	pF	$V_{AB} = 0.4 \sin(30e^6\pi t)\text{ V},^2$ DE = 0 V
Input Capacitance Balance ( $C_A/C_B$ ) (Transceiver with Driver Disabled)	$C_{A/B}$	0.99		1.01		DE = 0 V
<b>POWER SUPPLY</b>						
Supply Current						
Only Driver Enabled	$I_{CC}$		13	22	mA	DE, $\overline{RE} = V_{CC}, R_L = 50\ \Omega$
Both Driver and Receiver Disabled			1	4	mA	DE = 0 V, $\overline{RE} = V_{CC}, R_L = \text{no load}$
Both Driver and Receiver Enabled			16	24	mA	DE = $V_{CC}, \overline{RE} = 0\text{ V}, R_L = 50\ \Omega$
Only Receiver Enabled			4	13	mA	DE, $\overline{RE} = 0\text{ V}, R_L = 50\ \Omega$
Total Power Dissipation	$P_D$			94	mW	$R_L = 50\ \Omega$ , input (DI) = 50 MHz, 50% duty cycle square wave; DE = $V_{CC}$ ; $\overline{RE} = 0\text{ V}$ ; $T_A = 85^\circ\text{C}$

<sup>1</sup> All typical values are given for  $V_{CC} = 3.3\text{ V}$  and  $T_A = 25^\circ\text{C}$ .

<sup>2</sup> HP4194A impedance analyzer (or equivalent).

## RECEIVER INPUT THRESHOLD TEST VOLTAGES

$\overline{RE} = 0\text{ V}$ , H = high, L = low.

Table 3. Test Voltages for Type 1 Receiver

Applied Voltages		Input Voltage, Differential	Input Voltage, Common Mode	Receiver Output
$V_A$ (V)	$V_B$ (V)	$V_{ID}$ (V)	$V_{IC}$ (V)	RO
2.4	0	2.4	1.2	H
0	2.4	-2.4	1.2	L
3.425	3.375	0.05	3.4	H
3.375	3.425	-0.05	3.4	L
-0.975	-1.025	0.05	-1	H
-1.025	-0.975	-0.05	-1	L

Table 4. Test Voltages for Type 2 Receiver

Applied Voltages		Input Voltage, Differential	Input Voltage, Common Mode	Receiver Output
V <sub>A</sub> (V)	V <sub>B</sub> (V)	V <sub>ID</sub> (V)	V <sub>IC</sub> (V)	RO
2.4	0	2.4	1.2	H
0	2.4	-2.4	1.2	L
3.475	3.325	0.15	3.4	H
3.425	3.375	0.05	3.4	L
-0.925	-1.075	0.15	-1	H
-0.975	-1.025	0.05	-1	L

## TIMING SPECIFICATIONS

V<sub>CC</sub> = 3.0 V to 3.6 V; T<sub>A</sub> = T<sub>MIN</sub> to T<sub>MAX</sub>, unless otherwise noted.<sup>1</sup>

Table 5.

Parameter	Symbol	Min	Typ	Max	Unit	Test Conditions/Comments
<b>DRIVER</b>						
Maximum Data Rate		100			Mbps	
Propagation Delay	t <sub>PLH</sub> , t <sub>PHL</sub>	2	2.5	3.5	ns	See Figure 23, Figure 26
Differential Output Rise/Fall Time	t <sub>R</sub> , t <sub>F</sub>	2	2.6	3.2	ns	See Figure 23, Figure 26
Pulse Skew  t <sub>PHL</sub> - t <sub>PLH</sub>	t <sub>SK</sub>		30	150	ps	See Figure 23, Figure 26
Part-to-Part Skew	t <sub>SK(PP)</sub>			0.9	ns	See Figure 23, Figure 26
Period Jitter, rms (One Standard Deviation) <sup>2</sup>	t <sub>J(PER)</sub>		2	3	ps	50 MHz clock input <sup>3</sup> (see Figure 25)
Peak-to-Peak Jitter <sup>2,4</sup>	t <sub>J(PP)</sub>			150	ps	100 Mbps 2 <sup>15</sup> - 1 PRBS input <sup>5</sup> (see Figure 28)
Disable Time from High Level	t <sub>PHZ</sub>		4	7	ns	See Figure 24, Figure 27
Disable Time from Low Level	t <sub>PLZ</sub>		4	7	ns	See Figure 24, Figure 27
Enable Time to High Level	t <sub>PZH</sub>		4	7	ns	See Figure 24, Figure 27
Enable Time to Low Level	t <sub>PZL</sub>		4	7	ns	See Figure 24, Figure 27
<b>RECEIVER</b>						
Propagation Delay	t <sub>RPLH</sub> , t <sub>RPHL</sub>	2		6	ns	C <sub>L</sub> = 15 pF (see Figure 29, Figure 32)
Rise/Fall Time	t <sub>R</sub> , t <sub>F</sub>	1		2.3	ns	C <sub>L</sub> = 15 pF (see Figure 29, Figure 32)
Pulse Skew  t <sub>RPHL</sub> - t <sub>RPLH</sub>						C <sub>L</sub> = 15 pF (see Figure 29, Figure 32)
Type 1 Receiver (ADN4690E, ADN4692E)	t <sub>SK</sub>		100	300	ps	
Type 2 Receiver (ADN4694E, ADN4695E)	t <sub>SK</sub>		300	500	ps	
Part-to-Part Skew <sup>6</sup>	t <sub>SK(PP)</sub>			1	ns	C <sub>L</sub> = 15 pF (see Figure 29, Figure 32)
Period Jitter, RMS (One Standard Deviation) <sup>2</sup>	t <sub>J(PER)</sub>		4	7	ps	50 MHz clock input <sup>3</sup> (see Figure 31)
Peak-to-Peak Jitter <sup>2,4</sup>						100 Mbps 2 <sup>15</sup> - 1 PRBS input <sup>5</sup> (see Figure 34)
Type 1 Receiver (ADN4690E, ADN4692E)	t <sub>J(PP)</sub>		200	700	ps	
Type 2 Receiver (ADN4694E, ADN4695E)	t <sub>J(PP)</sub>		225	800	ps	
Disable Time from High Level	t <sub>RPHZ</sub>		6	10	ns	See Figure 30, Figure 33
Disable Time from Low Level	t <sub>RPLZ</sub>		6	10	ns	See Figure 30, Figure 33
Enable Time to High Level	t <sub>RPZH</sub>		10	15	ns	See Figure 30, Figure 33
Enable Time to Low Level	t <sub>RPZL</sub>		10	15	ns	See Figure 30, Figure 33

<sup>1</sup> All typical values are given for V<sub>CC</sub> = 3.3 V and T<sub>A</sub> = 25°C.

<sup>2</sup> Jitter parameters are guaranteed by design and characterization. Values do not include stimulus jitter.

<sup>3</sup> t<sub>R</sub> = t<sub>F</sub> = 0.5 ns (10% to 90%), measured over 30,000 samples.

<sup>4</sup> Peak-to-peak jitter specifications include jitter due to pulse skew (t<sub>SK</sub>).

<sup>5</sup> t<sub>R</sub> = t<sub>F</sub> = 0.5 ns (10% to 90%), measured over 100,000 samples.

<sup>6</sup> HP4194A impedance analyzer or equivalent.

## ABSOLUTE MAXIMUM RATINGS

$T_A = T_{MIN}$  to  $T_{MAX}$ , unless otherwise noted.

Table 6.

Parameter	Rating
$V_{CC}$	-0.5 V to +4 V
Digital Input Voltage (DE, $\overline{RE}$ , DI)	-0.5 V to +4 V
Receiver Input (A, B) Voltage	
Half-Duplex (ADN4690E, ADN4694E)	-1.8 V to +4 V
Full Duplex (ADN4692E, ADN4695E)	-4 V to +6 V
Receiver Output Voltage (RO)	-0.3 V to +4 V
Driver Output (A, B, Y, Z) Voltage	-1.8 V to +4 V
ESD Rating (A, B, Y, Z Pins)	
HBM (Human Body Model)	
Air Discharge	±15 kV
Contact Discharge	±8 kV
IEC 61000-4-2	
Air Discharge	±10 kV
Contact Discharge	±8 kV
ESD Rating (Other Pins, HBM)	±4 kV
ESD Rating (All Pins, FICDM)	±1.25 kV
Operating Temperature Range	-40°C to +85°C
Storage Temperature Range	-65°C to +150°C

Stresses at or above those listed under Absolute Maximum Ratings may cause permanent damage to the product. This is a stress rating only; functional operation of the product at these or any other conditions above those indicated in the operational section of this specification is not implied. Operation beyond the maximum operating conditions for extended periods may affect product reliability.

## THERMAL RESISTANCE

$\theta_{JA}$  is specified for the worst-case conditions, that is, a device soldered in a circuit board for surface-mount packages.

Table 7. Thermal Resistance

Package Type	$\theta_{JA}$	Unit
8-Lead SOIC	121	°C/W
14-Lead SOIC	86	°C/W

## ESD CAUTION



**ESD (electrostatic discharge) sensitive device.** Charged devices and circuit boards can discharge without detection. Although this product features patented or proprietary protection circuitry, damage may occur on devices subjected to high energy ESD. Therefore, proper ESD precautions should be taken to avoid performance degradation or loss of functionality.

PIN CONFIGURATIONS AND FUNCTION DESCRIPTIONS



Figure 3. ADN4690E/ADN4694E Pin Configuration

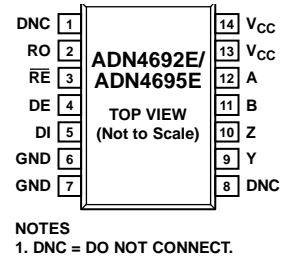

Figure 4. ADN4692E/ADN4695E Pin Configuration

Table 8. Pin Function Descriptions

ADN4690E/ ADN4694E Pin No. <sup>1</sup>	ADN4692E/ ADN4695E Pin No. <sup>1</sup>	Mnemonic	Description
1	2	RO	Receiver Output. Type 1 receiver (ADN4690E/ADN4692E), when enabled: If $A - B \geq 50$ mV, then RO = logic high. If $A - B \leq -50$ mV, then RO = logic low. Type 2 receiver (ADN4694E/ADN4695E), when enabled: If $A - B \geq 150$ mV, then RO = logic high. If $A - B \leq 50$ mV, then RO = logic low. Receiver output is undefined outside these conditions.
2	3	$\overline{RE}$	Receiver Output Enable. A logic low on this pin enables the receiver output, RO. A logic high on this pin places RO in a high impedance state.
3	4	DE	Driver Output Enable. A logic high on this pin enables the driver differential outputs. A logic low on this pin places the driver differential outputs in a high impedance state.
4	5	DI	Driver Input. Half-duplex (ADN4690E/ADN4694E), when enabled: A logic low on DI forces A low and B high, whereas a logic high on DI forces A high and B low. Full-duplex (ADN4692E/ADN4695E), when enabled: A logic low on DI forces Y low and Z high, whereas a logic high on DI forces Y high and Z low.
5	6, 7	GND	Ground.
N/A	9	Y	Noninverting Driver Output Y.
N/A	10	Z	Inverting Driver Output Z.
6	N/A	A	Noninverting Receiver Input A and Noninverting Driver Output A.
N/A	12	A	Noninverting Receiver Input A.
7	N/A	B	Inverting Receiver Input B and Inverting Driver Output B.
N/A	11	B	Inverting Receiver Input B.
8	13, 14	V <sub>CC</sub>	Power Supply (3.3 V ± 0.3 V).
N/A	1, 8	DNC	Do Not Connect. Do not connect to these pins.

<sup>1</sup> N/A means not applicable.

TYPICAL PERFORMANCE CHARACTERISTICS

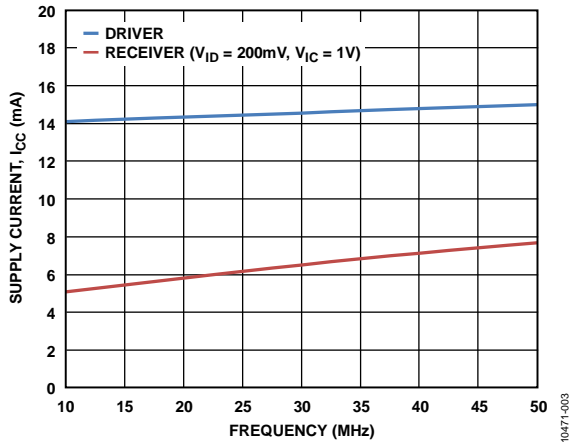

Figure 5. Power Supply Current vs. Frequency  
( $V_{CC} = 3.3\text{ V}$ ,  $T_A = 25^\circ\text{C}$ )

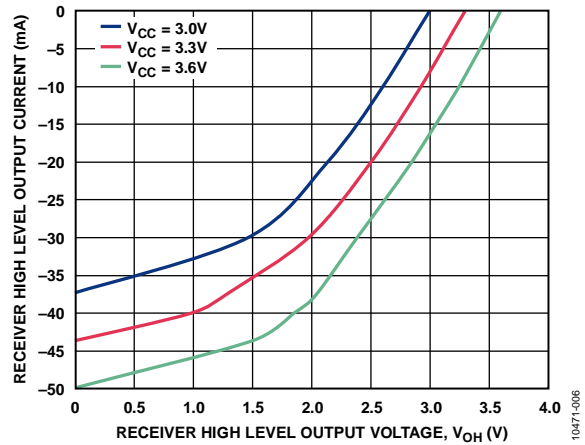

Figure 8. Receiver Output Current vs. Output Voltage (Output High)  
( $T_A = 25^\circ\text{C}$ )

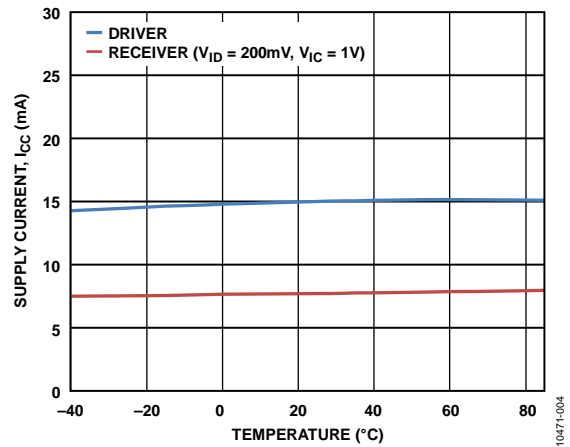

Figure 6. Power Supply Current vs. Temperature  
(Data Rate = 100 Mbps,  $V_{CC} = 3.3\text{ V}$ )

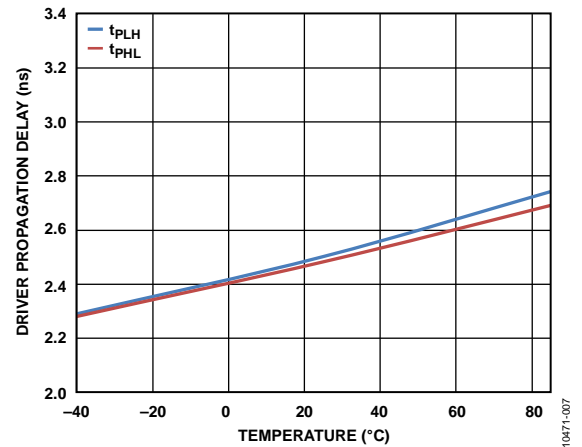

Figure 9. Driver Propagation Delay vs. Temperature  
(Data Rate = 2 Mbps,  $V_{CC} = 3.3\text{ V}$ ,  $R_L = 50\ \Omega$ )

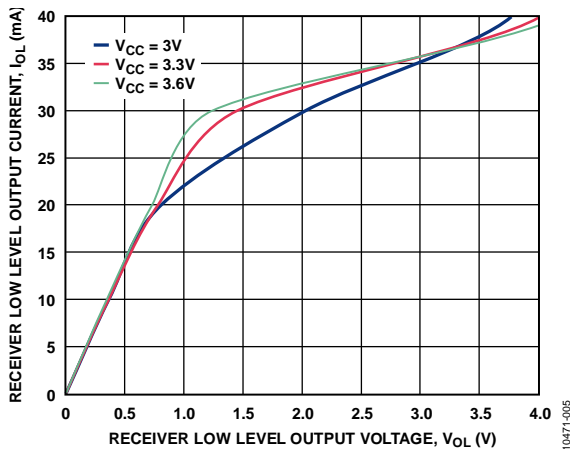

Figure 7. Receiver Output Current vs. Output Voltage (Output Low)  
( $T_A = 25^\circ\text{C}$ )

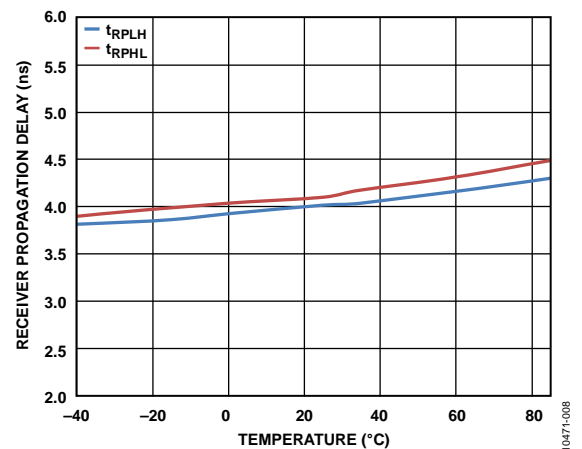

Figure 10. Receiver Propagation Delay vs. Temperature  
(Data Rate = 2 Mbps,  $V_{CC} = 3.3\text{ V}$ ,  $V_{ID} = 200\text{ mV}$ ,  $V_{IC} = 1\text{ V}$ ,  $C_L = 15\text{ pF}$ )





Figure 11. Driver Jitter (Period) vs. Frequency  
( $V_{CC} = 3.3\text{ V}$ ,  $T_A = 25^\circ\text{C}$ , Clock Input)

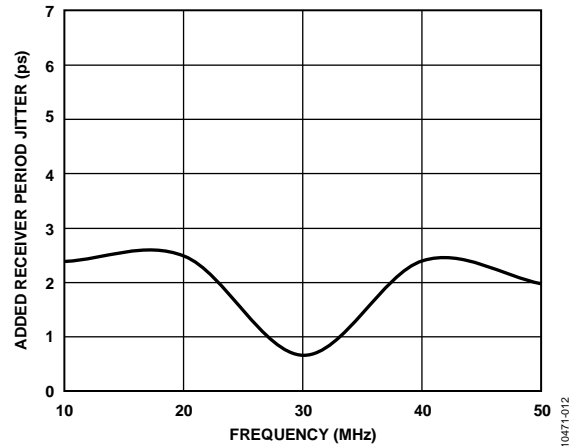

Figure 14. Receiver Jitter (Period) vs. Frequency  
( $V_{CC} = 3.3\text{ V}$ ,  $T_A = 25^\circ\text{C}$ ,  $V_{IC} = 1\text{ V}$ , Clock Input)



Figure 12. Driver Jitter (Peak-to-Peak) vs. Data Rate  
( $V_{CC} = 3.3\text{ V}$ ,  $T_A = 25^\circ\text{C}$ , PRBS  $2^{15} - 1$  NRZ Input)

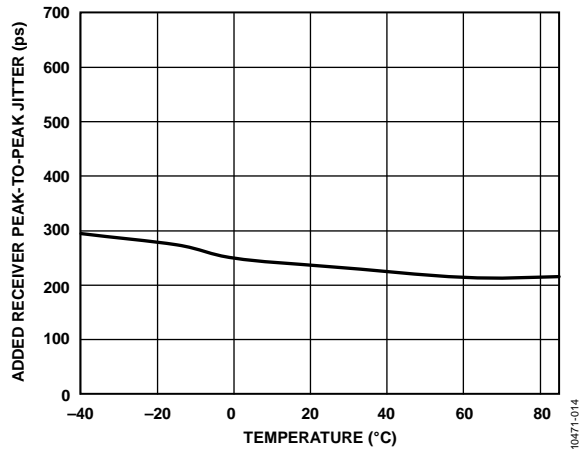

Figure 15. Receiver Jitter (Peak-to-Peak) vs. Temperature  
( $V_{CC} = 3.3\text{ V}$ ,  $V_{IC} = 1\text{ V}$ , PRBS  $2^{15} - 1$  NRZ Input)



Figure 13. Driver Jitter (Peak-to-Peak) vs. Temperature  
(Data Rate = 100 Mbps,  $V_{CC} = 3.3\text{ V}$ ,  $T_A = 25^\circ\text{C}$ , PRBS  $2^{15} - 1$  NRZ Input)



Figure 16. ADN4690E Driver Output Eye Pattern  
(Data Rate = 100 Mbps, PRBS  $2^{15} - 1$  Input,  $R_L = 50 \Omega$ )



Figure 17. ADN4690E Receiver Output Eye Pattern  
(Data Rate = 100 Mbps, PRBS  $2^{15} - 1$ ,  $C_L = 15 \text{ pF}$ )

# TEST CIRCUITS AND SWITCHING CHARACTERISTICS

## DRIVER VOLTAGE AND CURRENT MEASUREMENTS



NOTES  
1. 1% TOLERANCE FOR ALL RESISTORS.

Figure 18. Driver Voltage Measurement over Common-Mode Range

10471-017

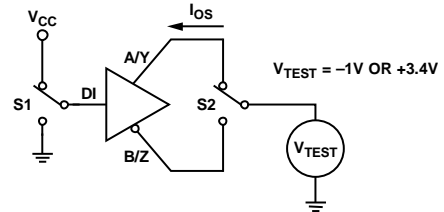

Figure 21. Driver Short Circuit

10471-020



NOTES  
1. C1, C2, AND C3 ARE 20% AND INCLUDE PROBE/STRAY CAPACITANCE < 2cm FROM DUT.  
2. R1 AND R2 ARE 1%, METAL FILM, SURFACE MOUNT, < 2cm FROM DUT.

Figure 19. Driver Common-Mode Output Voltage Measurement

10471-018



NOTES  
1. INPUT PULSE GENERATOR: 1MHz; 50% ± 5% DUTY CYCLE;  $t_r, t_f \leq 1$ ns.  
2.  $V_{OC(PP)}$  MEASURED ON TEST EQUIPMENT WITH -3dB BANDWIDTH ≥ 1GHz.

Figure 22. Driver Common-Mode Output Voltage (Steady State)

10471-021



Figure 20. Maximum Steady-State Output Voltage Measurement

10471-019

DRIVER TIMING MEASUREMENTS

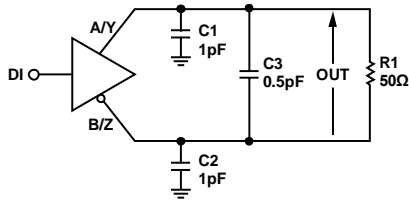

- NOTES
1. C1, C2, AND C3 ARE 20% AND INCLUDE PROBE/STRAY CAPACITANCE < 2cm FROM DUT.
  2. R1 IS 1%, METAL FILM, SURFACE MOUNT, <2cm FROM DUT.

Figure 23. Driver Timing Measurement

10471-022

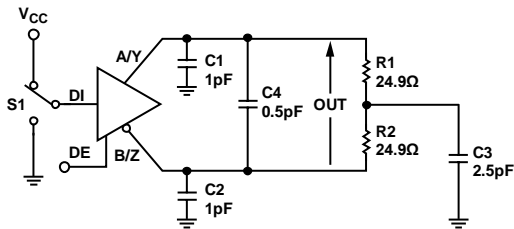

- NOTES
1. C1, C2, C3, AND C4 ARE 20% AND INCLUDE PROBE/STRAY CAPACITANCE < 2cm FROM DUT.
  2. R1 AND R2 ARE 1%, METAL FILM, SURFACE MOUNT, <2cm FROM DUT.

Figure 24. Driver Enable/Disable Time Test Circuit

10471-023

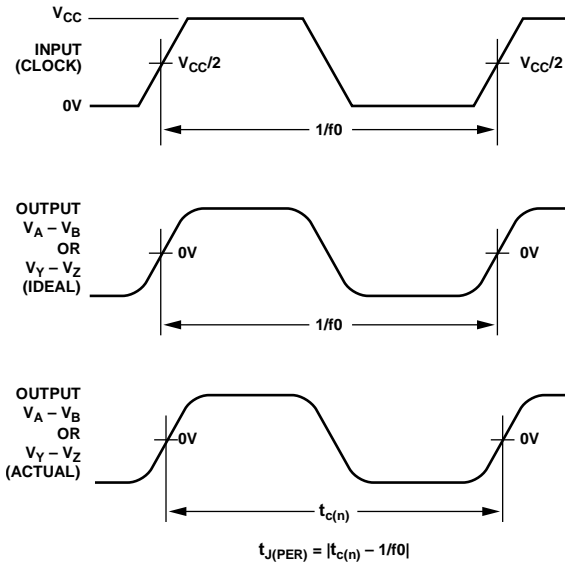

- NOTES
1. INPUT PULSE GENERATOR: AGILENT 8304A STIMULUS SYSTEM; 50MHz; 50% ± 1% DUTY CYCLE.
  2. MEASURED USING TEK TDS6604 WITH TDSJIT3 SOFTWARE.

Figure 25. Driver Period Jitter Characteristics

10471-024

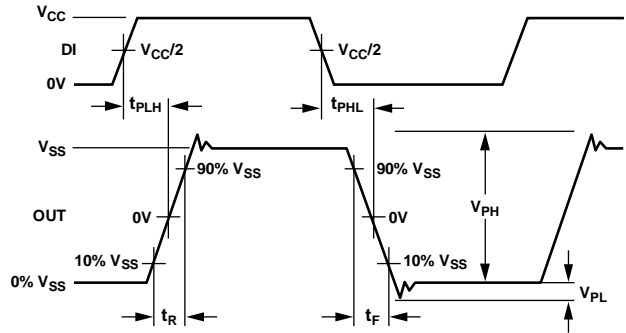

- NOTES
1. INPUT PULSE GENERATOR: 1MHz; 50% ± 5% DUTY CYCLE;  $t_R, t_F \leq 1ns$ .
  2. MEASURED ON TEST EQUIPMENT WITH -3dB BANDWIDTH ≥ 1GHz.

Figure 26. Driver Propagation, Rise/Fall Times and Voltage Overshoot

10471-025



- NOTES
1. INPUT PULSE GENERATOR: 1MHz; 50% ± 5% DUTY CYCLE;  $t_R, t_F \leq 1ns$ .
  2. MEASURED ON TEST EQUIPMENT WITH -3dB BANDWIDTH ≥ 1GHz.

Figure 27. Driver Enable/Disable Times

10471-026



- NOTES
1. INPUT PULSE GENERATOR: AGILENT 8304A STIMULUS SYSTEM; 100Mbps;  $2^{15} - 1$ PRBS.
  2. MEASURED USING TEK TDS6604 WITH TDSJIT3 SOFTWARE.

Figure 28. Driver Peak-to-Peak Jitter Characteristics

10471-027

RECEIVER TIMING MEASUREMENTS

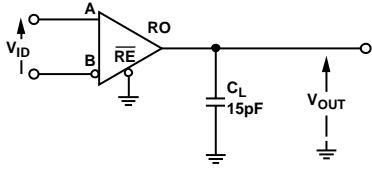

NOTES  
 1.  $C_L$  IS 20%, CERAMIC, SURFACE MOUNT, AND INCLUDES PROBE/STRAY CAPACITANCE < 2cm FROM DUT.

Figure 29. Receiver Timing Measurement

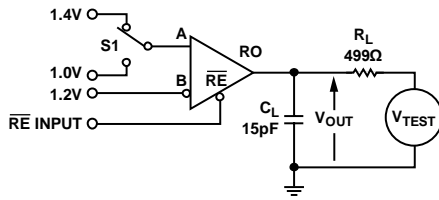

NOTES  
 1.  $C_L$  IS 20% AND INCLUDES PROBE/STRAY CAPACITANCE < 2cm FROM DUT.  
 2.  $R_L$  IS 1% METAL FILM, SURFACE MOUNT, < 2cm FROM DUT.

Figure 30. Receiver Enable/Disable Time

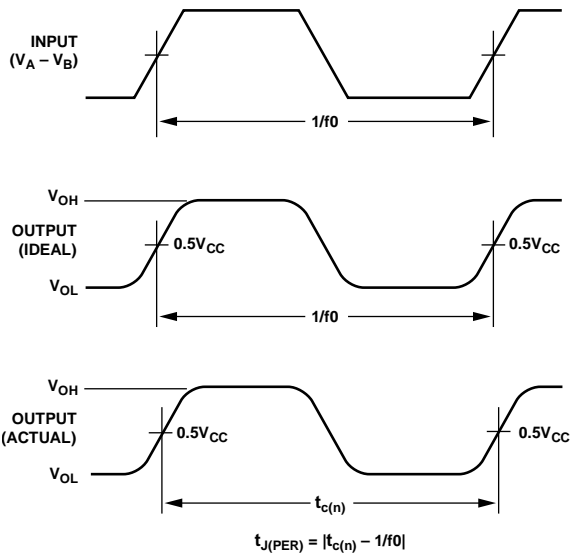

NOTES  
 1. INPUT PULSE GENERATOR: AGILENT 8304A STIMULUS SYSTEM; 50MHz; 50% ± 1% DUTY CYCLE.  
 2. MEASURED USING TEK TDS6604 WITH TDSJIT3 SOFTWARE.

Figure 31. Receiver Period Jitter Characteristics



NOTES  
 1. INPUT PULSE GENERATOR: 1MHz; 50% ± 5% DUTY CYCLE;  $t_R$ ,  $t_F$  ≤ 1ns.  
 2. MEASURED ON TEST EQUIPMENT WITH -3dB BANDWIDTH ≥ 1GHz.

Figure 32. Receiver Propagation and Rise/Fall Times



NOTES  
 1. INPUT PULSE GENERATOR: 1MHz; 50 ± 5% DUTY CYCLE;  $t_R$ ,  $t_F$  ≤ 1ns.

Figure 33. Receiver Enable/Disable Times



NOTES  
 1. INPUT PULSE GENERATOR: AGILENT 8304A STIMULUS SYSTEM; 100Mbps; 2<sup>15</sup> - 1PRBS.  
 2. MEASURED USING TEK TDS6604 WITH TDSJIT3 SOFTWARE.

Figure 34. Receiver Peak-to-Peak Jitter Characteristics

## THEORY OF OPERATION

The ADN4690E/ADN4692E/ADN4694E/ADN4695E are transceivers for transmitting and receiving multipoint, low voltage differential signaling (M-LVDS) at high speed (data rates up to 100 Mbps). Each device has a differential line driver and a differential line receiver, allowing each device to send and receive data.

Multipoint LVDS expands on the established LVDS low voltage differential signaling method by allowing bidirectional communication between more than two nodes. Up to 32 nodes can be connected on an M-LVDS bus.

### HALF-DUPLEX/FULL-DUPLEX OPERATION

Half-duplex operation allows a transceiver to transmit or receive, but not both at the same time. However, with full-duplex operation, a transceiver can transmit and receive simultaneously. The ADN4690E/ADN4694E are half-duplex devices in which the driver and the receiver share differential bus terminals. The ADN4692E/ADN4695E are full-duplex devices that have dedicated driver output and receiver input pins. Figure 36 and Figure 37 show typical half- and full-duplex bus topologies, respectively, for M-LVDS.

### THREE-STATE BUS CONNECTION

The outputs of the device can be placed in a high impedance state by disabling the driver or receiver. This allows several driver outputs to be connected to a single M-LVDS bus. Note that, on each bus line, only one driver can be enabled at a time, but many receivers can be enabled at the same time.

The driver can be enabled or disabled using the driver enable pin (DE). DE enables the driver outputs when taken high; when taken low, DE puts the driver outputs into a high impedance state. Similarly, an active low receiver enable pin ( $\overline{RE}$ ) controls the receiver. Taking this pin low enables the receiver, whereas taking it high puts the receiver outputs into a high impedance state.

Truth tables for driver and receiver output states under various conditions are shown in Table 10, Table 11, Table 12, and Table 13.

### TRUTH TABLES

Table 9. Truth Table Abbreviations

Abbreviation	Description
H	High level
L	Low level
X	Don't care
I	Indeterminate
Z	High impedance (off)
NC	Disconnected

### Driver, Half Duplex (ADN4690E/ADN4694E)

Table 10. Transmitting (see Table 9 for Abbreviations)

Power	Inputs		Outputs	
	DE	DI	A	B
Yes	H	H	H	L
Yes	H	L	L	H
Yes	H	NC	L	H
Yes	L	X	Z	Z
Yes	NC	X	Z	Z
≤1.5 V	X	X	Z	Z

### Driver, Full Duplex (ADN4692E/ADN4695E)

Table 11. Transmitting (see Table 9 for Abbreviations)

Power	Inputs		Outputs	
	DE	DI	Y	Z
Yes	H	H	H	L
Yes	H	L	L	H
Yes	H	NC	L	H
Yes	L	X	Z	Z
Yes	NC	X	Z	Z
≤1.5 V	X	X	Z	Z

### Type 1 Receiver (ADN4690E/ADN4692E)

Table 12. Receiving (see Table 9 for Abbreviations)

Power	Inputs		Output	
	A – B	$\overline{RE}$	RO	
Yes	≥50 mV	L	H	
Yes	≤–50 mV	L	L	
Yes	–50 mV < A – B < 50 mV	L	I	
Yes	NC	L	I	
Yes	X	H	Z	
Yes	X	NC	Z	
No	X	X	Z	

### Type 2 Receiver (ADN4694E/ADN4695E)

Table 13. Receiving (see Table 9 for Abbreviations)

Power	Inputs		Output	
	A – B	$\overline{RE}$	RO	
Yes	≥150 mV	L	H	
Yes	≤50 mV	L	L	
Yes	50 mV < A – B < 150 mV	L	I	
Yes	NC	L	L	
Yes	X	H	Z	
Yes	X	NC	Z	
No	X	X	Z	

### GLITCH-FREE POWER-UP/POWER-DOWN

To minimize disruption to the bus when adding nodes, the M-LVDS outputs of the device are kept glitch-free when the device is powering up or down. This feature allows insertion of devices onto a live M-LVDS bus because the bus outputs are not switched on before the device is fully powered. In addition, all outputs are placed in a high impedance state when the device is powered off.

### FAULT CONDITIONS

The ADN4690E/ADN4692E/ADN4694E/ADN4695E contain short-circuit current protection that protects the part under fault conditions in the case of short circuits on the bus. This protection limits the current in a fault condition to 24 mA at the transmitter outputs for short-circuit faults between  $-1$  V and  $+3.4$  V. Any network fault must be cleared to avoid data transmission errors and to ensure reliable operation of the data network and any devices that are connected to the network.

### RECEIVER INPUT THRESHOLDS/FAIL-SAFE

Two receiver types are available, both of which incorporate protection against short circuits.

The Type 1 receivers of the ADN4690E/ADN4692E incorporate 25 mV of hysteresis. This ensures that slow-changing signals or a loss of input does not result in oscillation of the receiver output. Type 1 receiver thresholds are  $\pm 50$  mV; therefore, the state of the receiver output is indeterminate if the differential between A and B is about 0 V. This state occurs if the bus is idle (approximately 0 V on both A and B), with no drivers enabled on the attached nodes.

Type 2 receivers (ADN4694E/ADN4695E) have an open circuit and bus-idle fail-safe. The input threshold is offset by 100 mV so that a logic low is present on the receiver output when the bus is idle or when the receiver inputs are open.

The different receiver thresholds for the two receiver types are illustrated in Figure 35. See Table 12 and Table 13 for receiver output states under various conditions.

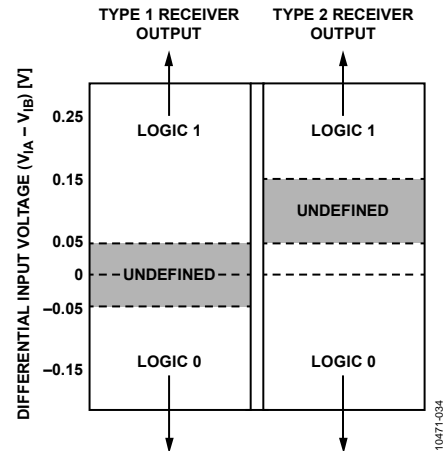

Figure 35. Input Threshold Voltages

### APPLICATIONS INFORMATION

M-LVDS extends the low power, high speed, differential signaling of LVDS (low voltage differential signaling) to multipoint systems where multiple nodes are connected over short distances in a bus topology network.

With M-LVDS, a transmitting node drives a differential signal across a transmission medium such as a twisted pair cable. The transmitted differential signal allows other receiving nodes that are connected along the bus to detect a differential voltage that can then be converted back into a single-ended logic signal by the receiver.

The communication line is typically terminated at both ends by resistors ( $R_T$ ), the value of which is chosen to match the characteristic impedance of the medium (typically 100  $\Omega$ ).

For half-duplex multipoint applications such as the one shown in Figure 36, only one driver can be enabled at any time. Full-duplex nodes allow a master slave topology, as shown in Figure 37. In this configuration, a master node can concurrently send and receive data to/from slave nodes. At any time, only one slave node can have its driver enabled to concurrently transmit data back to the master node.



- NOTES  
 1. MAXIMUM NUMBER OF NODES: 32.  
 2.  $R_T$  IS EQUAL TO THE CHARACTERISTIC IMPEDANCE OF THE CABLE USED.

Figure 36. ADN4694E Typical Half-Duplex M-LVDS Network (Type 2 Receivers with Threshold Offset for Bus-Idle Fail-Safe)

10471-035



- NOTES  
 1. MAXIMUM NUMBER OF NODES: 32.  
 2.  $R_T$  IS EQUAL TO THE CHARACTERISTIC IMPEDANCE OF THE CABLE USED.

Figure 37. ADN4695E Typical Full-Duplex M-LVDS Master-Slave Network (Type 2 Receivers with Threshold Offset for Bus-Idle Fail-Safe)

10471-036



OUTLINE DIMENSIONS



COMPLIANT TO JEDEC STANDARDS MS-012-AA  
 CONTROLLING DIMENSIONS ARE IN MILLIMETERS; INCH DIMENSIONS  
 (IN PARENTHESES) ARE ROUNDED-OFF MILLIMETER EQUIVALENTS FOR  
 REFERENCE ONLY AND ARE NOT APPROPRIATE FOR USE IN DESIGN.

Figure 38. 8-Lead Standard Small Outline Package [SOIC\_N]  
 Narrow Body  
 (R-8)

Dimensions shown in millimeters and (inches)

012407-A

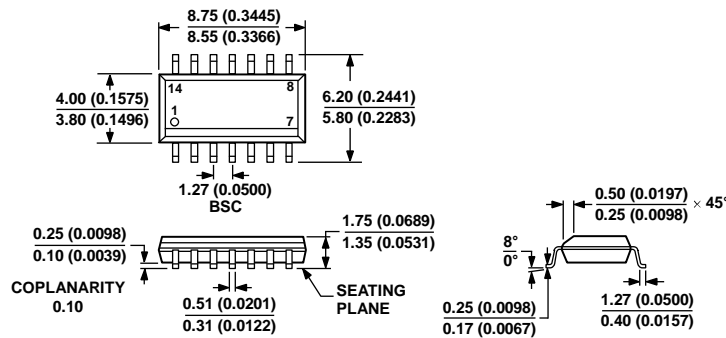

COMPLIANT TO JEDEC STANDARDS MS-012-AB  
 CONTROLLING DIMENSIONS ARE IN MILLIMETERS; INCH DIMENSIONS  
 (IN PARENTHESES) ARE ROUNDED-OFF MILLIMETER EQUIVALENTS FOR  
 REFERENCE ONLY AND ARE NOT APPROPRIATE FOR USE IN DESIGN.

Figure 39. 14-Lead Standard Small Outline Package [SOIC\_N]  
 Narrow Body  
 (R-14)

Dimensions shown in millimeters and (inches)

060606-A

ORDERING GUIDE

Model <sup>1</sup>	Temperature Range	Package Description	Package Option
ADN4690EBRZ	-40°C to +85°C	8-Lead Standard Small Outline Package (SOIC_N)	R-8
ADN4690EBRZ-RL7	-40°C to +85°C	8-Lead Standard Small Outline Package (SOIC_N)	R-8
ADN4692EBRZ	-40°C to +85°C	14-Lead Standard Small Outline Package (SOIC_N)	R-14
ADN4692EBRZ-RL7	-40°C to +85°C	14-Lead Standard Small Outline Package (SOIC_N)	R-14
ADN4694EBRZ	-40°C to +85°C	8-Lead Standard Small Outline Package (SOIC_N)	R-8
ADN4694EBRZ-RL7	-40°C to +85°C	8-Lead Standard Small Outline Package (SOIC_N)	R-8
ADN4695EBRZ	-40°C to +85°C	14-Lead Standard Small Outline Package (SOIC_N)	R-14
ADN4695EBRZ-RL7	-40°C to +85°C	14-Lead Standard Small Outline Package (SOIC_N)	R-14
EVAL-ADN469xEHDEBZ		Evaluation Board for Half-Duplex M-LVDS (ADN4690E, ADN4694E)	
EVAL-ADN469xEFDEBZ		Evaluation Board for Full-Duplex M-LVDS (ADN4692E, ADN4695E)	

<sup>1</sup> Z = RoHS Compliant Part.

**NOTES**

**NOTES**

**NOTES**

Компания «Океан Электроники» предлагает заключение долгосрочных отношений при поставках импортных электронных компонентов на взаимовыгодных условиях!

Наши преимущества:

- Поставка оригинальных импортных электронных компонентов напрямую с производств Америки, Европы и Азии, а так же с крупнейших складов мира;
- Широкая линейка поставок активных и пассивных импортных электронных компонентов (более 30 млн. наименований);
- Поставка сложных, дефицитных, либо снятых с производства позиций;
- Оперативные сроки поставки под заказ (от 5 рабочих дней);
- Экспресс доставка в любую точку России;
- Помощь Конструкторского Отдела и консультации квалифицированных инженеров;
- Техническая поддержка проекта, помощь в подборе аналогов, поставка прототипов;
- Поставка электронных компонентов под контролем ВП;
- Система менеджмента качества сертифицирована по Международному стандарту ISO 9001;
- При необходимости вся продукция военного и аэрокосмического назначения проходит испытания и сертификацию в лаборатории (по согласованию с заказчиком);
- Поставка специализированных компонентов военного и аэрокосмического уровня качества (Xilinx, Altera, Analog Devices, Intersil, Interpoint, Microsemi, Actel, Aeroflex, Peregrine, VPT, Syfer, Eurofarad, Texas Instruments, MS Kennedy, Miteq, Cobham, E2V, MA-COM, Hittite, Mini-Circuits, General Dynamics и др.);

Компания «Океан Электроники» является официальным дистрибьютором и эксклюзивным представителем в России одного из крупнейших производителей разъемов военного и аэрокосмического назначения «JONHON», а так же официальным дистрибьютором и эксклюзивным представителем в России производителя высокотехнологичных и надежных решений для передачи СВЧ сигналов «FORSTAR».



## JONHON

«JONHON» (основан в 1970 г.)

Разъемы специального, военного и аэрокосмического назначения:

(Применяются в военной, авиационной, аэрокосмической, морской, железнодорожной, горно- и нефтедобывающей отраслях промышленности)

«FORSTAR» (основан в 1998 г.)

ВЧ соединители, коаксиальные кабели, кабельные сборки и микроволновые компоненты:

(Применяются в телекоммуникациях гражданского и специального назначения, в средствах связи, РЛС, а так же военной, авиационной и аэрокосмической отраслях промышленности).



Телефон: 8 (812) 309-75-97 (многоканальный)

Факс: 8 (812) 320-03-32

Электронная почта: [ocean@oceanchips.ru](mailto:ocean@oceanchips.ru)

Web: <http://oceanchips.ru/>

Адрес: 198099, г. Санкт-Петербург, ул. Калинина, д. 2, корп. 4, лит. А