

## DESCRIPTION

The MP6529 is a gate driver IC designed for three-phase, brushless DC motor driver applications; it is capable of driving three half-bridges consisting of six N-channel power MOSFETs up to 35V.

The MP6529 uses a bootstrap capacitor to generate a supply voltage for the high-side MOSFET driver. An internal trickle-charge circuit maintains a sufficient gate driver voltage at 100% duty cycle.

Full protection features include programmable over-current protection (OCP), adjustable dead-time control, under-voltage lockout (UVLO), and thermal shutdown.

The MP6529 is available in a 28-pin TSSOP (9.7mmx6.4mm) package with an exposed thermal pad and a 28-contact QFN (4mmx4mm) package with an exposed thermal pad.

## FEATURES

- Wide 5V to 35V Input Voltage Range
- Bootstrap Gate Driver with Trickle-Charge Circuit Supports 100% Duty Cycle Operation
- Low-Power Sleep Mode for Battery-Powered Applications
- Programmable Over-Current Protection of External MOSFETs
- Adjustable Dead-Time Control to Prevent Shoot-Through
- Thermal Shutdown and UVLO Protection
- Fault Indication Output
- Thermally Enhanced Surface-Mount Package

## APPLICATIONS

- Three-Phase, Brushless DC Motors and Permanent Magnet Synchronous Motors
- Power Drills
- Impact Drivers
- E-Cigar
- E-Bike

All MPS parts are lead-free, halogen-free, and adhere to the RoHS directive. For MPS green status, please visit the MPS website under Quality Assurance. "MPS" and "The Future of Analog IC Technology" are registered trademarks of Monolithic Power Systems, Inc.

## TYPICAL APPLICATION

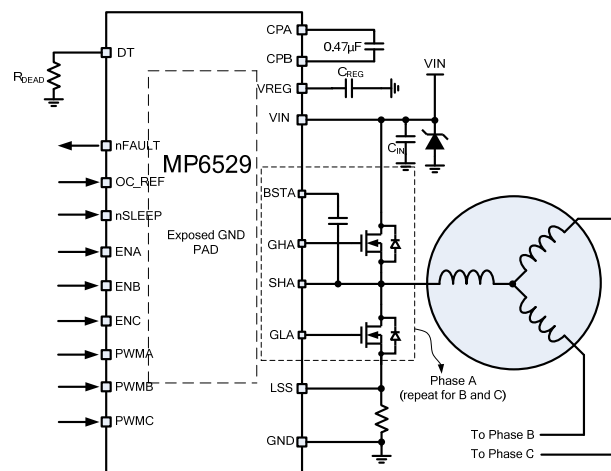

**ORDERING INFORMATION**

<b>Part Number</b>	<b>Package</b>	<b>Top Marking</b>
MP6529GR*	QFN-28 (4mmx4mm)	<i>See Below</i>
MP6529GF**	TSSOP-28 EP (9.7mmx6.4mm)	<i>See Below</i>

\* For Tape & Reel, add suffix -Z (e.g. MP6529GR-Z)

\*\* For Tape & Reel, add suffix -Z (e.g. MP6529GF-Z)

**TOP MARKING (MP6529GR)**

**MPSYWW**

**MP6529**

**LLLLLLL**

MPS: MPS prefix  
Y: Year code  
WW: Week code  
MP6529: Part number  
LLLLLL: Lot number

**TOP MARKING (MP6529GF)**

**MPSYYWW**

**MP6529**

**LLLLLLLLLLL**

MPS: MPS prefix  
YY: Year code  
WW: Week code  
MP6529: Part number  
LLLLLLLLLL: Lot number

## PACKAGE REFERENCE

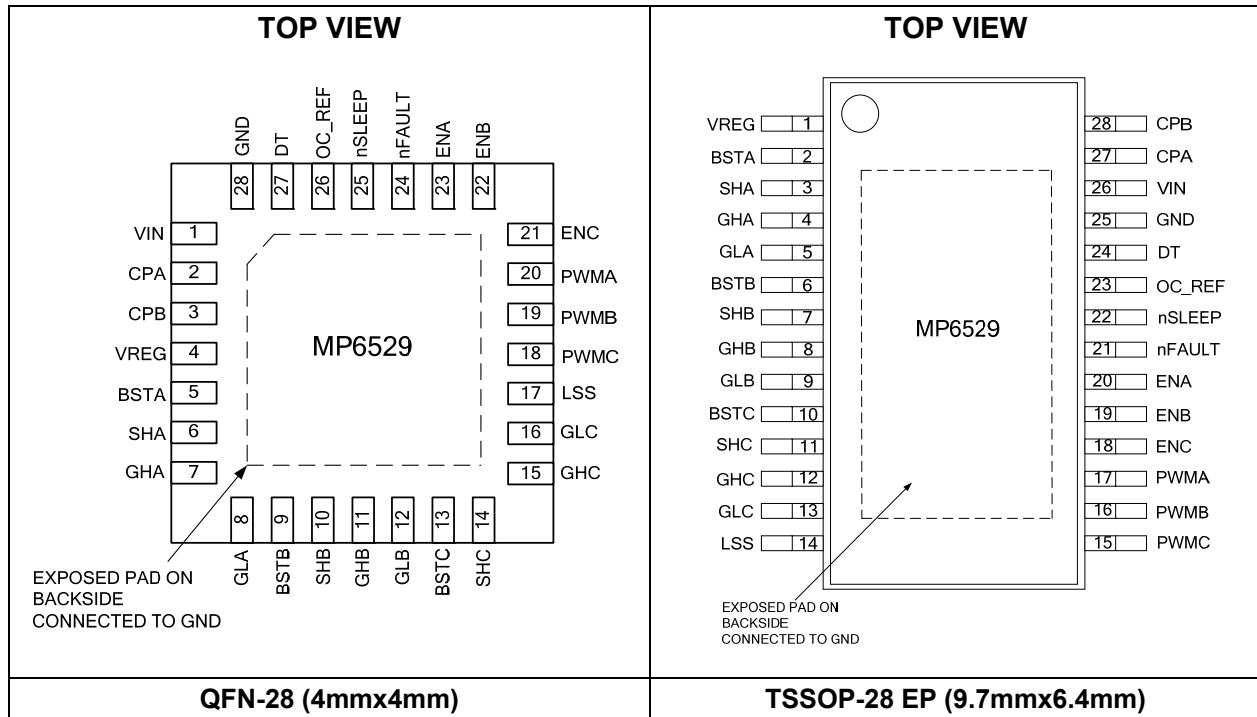

### ABSOLUTE MAXIMUM RATINGS <sup>(1)</sup>

Input voltage ( $V_{IN}$ )	-0.3V to 40V
CPA	-0.3V to 40V
CPB	-0.3V to 12.5V
VREG	-0.3V to 13V
BSTA/B/C	-0.3V to 55V
GHA/B/C	-0.3V to 55V
SHA/B/C	-0.3V to 40V
GLA/B/C	-0.3V to 13V
All other pins to AGND	-0.3V to 6.5V
<b>Continuous power dissipation (<math>T_A = +25^\circ\text{C}</math>) <sup>(2)</sup></b>	
QFN-28 (4mmx4mm)	2.9W
TSSOP-28 EP (9.7mmx6.4mm)	3.9W
Storage temperature	-55°C to +150°C
Junction temperature	+150°C
Lead temperature (solder)	+260°C

### Recommended Operating Conditions <sup>(3)</sup>

Input voltage ( $V_{IN}$ )	5V to 35V
OC_REF voltage ( $V_{OC}$ )	0.125V to 2.4V
Operating junct. temp ( $T_J$ )	-40°C to +125°C

### Thermal Resistance <sup>(4)</sup>

	$\theta_{JA}$	$\theta_{JC}$
QFN-28 (4mmx4mm)	42	9
TSSOP-28 EP (9.7mmx6.4mm)	32	6

#### NOTES:

- 1) Exceeding these ratings may damage the device.
- 2) The maximum allowable power dissipation is a function of the maximum junction temperature  $T_J$  (MAX), the junction-to-ambient thermal resistance  $\theta_{JA}$ , and the ambient temperature  $T_A$ . The maximum allowable continuous power dissipation at any ambient temperature is calculated by  $P_D$  (MAX) =  $(T_J$  (MAX) -  $T_A$ ) /  $\theta_{JA}$ . Exceeding the maximum allowable power dissipation produces an excessive die temperature, causing the regulator to go into thermal shutdown. Internal thermal shutdown circuitry protects the device from permanent damage.
- 3) The device is not guaranteed to function outside of its operating conditions.
- 4) Measured on JESD51-7, 4-layer PCB.

## ELECTRICAL CHARACTERISTICS

$V_{IN} = 24V$ ,  $T_A = 25^{\circ}C$ , unless otherwise noted.

Parameter	Symbol	Condition	Min	Typ	Max	Units
<b>Power Supply</b>						
Input supply voltage	$V_{IN}$		5		35	V
Quiescent current	$I_Q$	nSLEEP = 1, gate not switching		0.95	2	mA
	$I_{SLEEP}$	nSLEEP = 0			1	$\mu A$
<b>Control Logic</b>						
Input logic low threshold	$V_{IL}$				0.8	V
Input logic high threshold	$V_{IH}$		2			V
Logic input current	$I_{IN(H)}$	$V_{IH} = 5V$	-20		20	$\mu A$
	$I_{IN(L)}$	$V_{IL} = 0.8V$	-20		20	$\mu A$
nSLEEP pull-down current	$I_{SLEEP-PD}$			1		$\mu A$
Internal pull-down resistance	$R_{PD}$			880		k $\Omega$
<b>Fault Outputs (Open-Drain Outputs)</b>						
Output low voltage	$V_{OL}$	$I_O = 5mA$			0.5	V
Output high leakage current	$I_{OH}$	$V_O = 3.3V$			1	$\mu A$
<b>Protection Circuit</b>						
UVLO rising threshold	$V_{IN\ RISE}$		3.3	3.9	4.5	V
UVLO hysteresis	$V_{IN\ HYS}$			200		mV
VREG rising threshold	$V_{REG\ RISE}$		6.8	7.6	8.4	V
VREG hysteresis	$V_{REG\ HYS}$			0.54	1	V
VREG start-up delay	$t_{REG}$			700		$\mu s$
OC_REF threshold	$V_{OC}$	$V_{OC} = 1V$	0.8	1	1.2	V
		$V_{OC} = 2.4V$	2.18	2.4	2.62	V
OCP deglitch time	$t_{OC}$			3		$\mu s$
SLEEP wake-up time	$t_{SLEEP}$			1		ms
LSS OCP threshold	$V_{LSS-OC}$		0.4	0.5	0.6	V
Thermal shutdown	$T_{TSD}$			150		$^{\circ}C$

**ELECTRICAL CHARACTERISTICS** *(continued)*
 $V_{IN} = 24V$ ,  $T_A = 25^{\circ}C$ , unless otherwise noted.

Parameter	Symbol	Condition	Min	Typ	Max	Units
<b>Gate Drive</b>						
Bootstrap diode forward voltage	$V_{FBOOT}$	$I_D = 10mA$			0.9	V
		$I_D = 100mA$			1.3	V
VREG output voltage	$V_{REG}$	$V_{IN} = 5.5V-35V$	10	11.5	12.8	
		$V_{IN} = 5V$	$2xV_{IN}-1$			V
Maximum source current	$I_{OSO}^{(5)}$			0.8		A
Maximum sink current	$I_{OSI}^{(5)}$			1		A
Gate drive pull-up resistance	$R_{UP}$	$V_{DS} = 1V$		8		$\Omega$
HS gate drive pull-down resistance	$R_{HS-DN}$	$V_{DS} = 1V$	1.2		4.7	$\Omega$
LS gate drive pull-down resistance	$R_{LS-DN}$	$V_{DS} = 1V$	1		5.5	$\Omega$
LS passive pull-down resistance	$R_{LS-PDN}$			590		k $\Omega$
LS automatic turn-on time	$t_{LS}$			1.8		$\mu s$
Charge pump frequency	$f_{CP}$			110		kHz
Dead time	$t_{DEAD}$	Leave DT open		6		$\mu s$
		$R_{DT} = 200k\Omega$		0.74		$\mu s$
		DT tied to GND		30		ns

**NOTE:**

5) Guaranteed by design.

## TYPICAL CHARACTERISTICS

$V_{IN} = 24V$ ,  $OC\_REF = 0.5V$ ,  $R_{DT} = 200k$ ,  $ENA = ENC = H$ ,  $F_{PWM} = 20kHz$ ,  $T_A = 25^\circ C$ ,  
 resistor + inductor load:  $5\Omega + 1mH$ /phase with star connection, unless otherwise noted.

**Quiescent Current vs. Temperature**

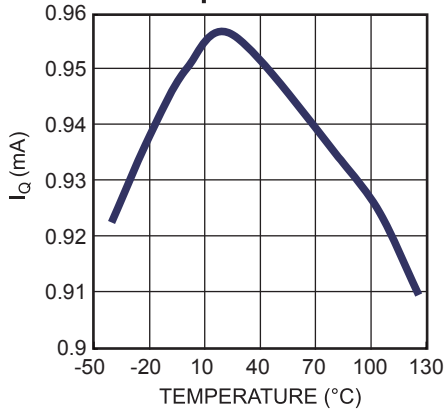

**UVLO Rising Threshold vs. Temperature**

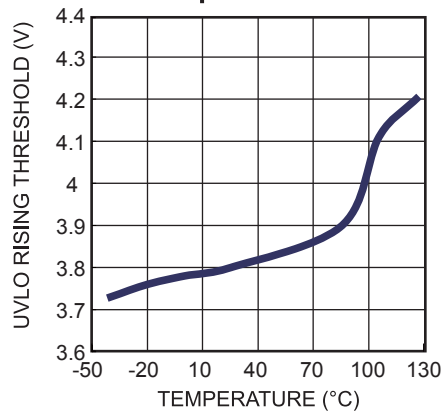

**VREG Rising Threshold vs. Temperature**

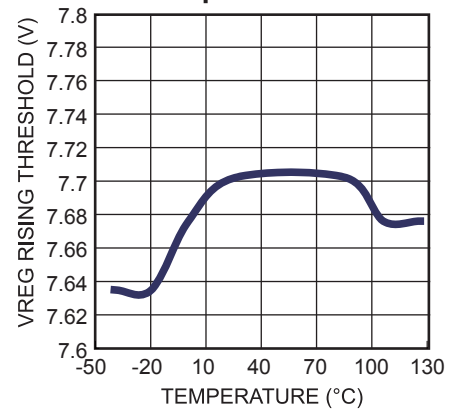

**OC\_REF Threshold vs. Temperature**

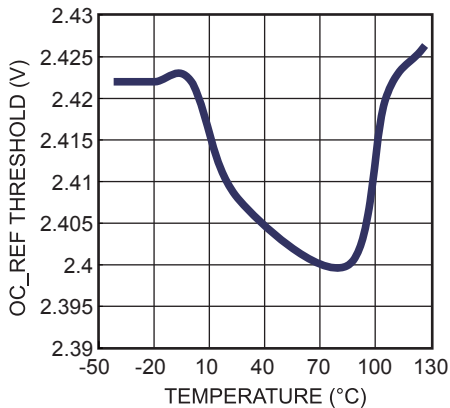

**LSS OCP Threshold vs. Temperature**

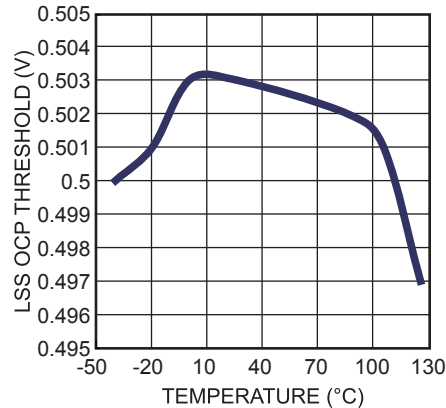

**TYPICAL PERFORMANCE CHARACTERISTICS (continued)**

$V_{IN} = 24V$ ,  $OC\_REF = 0.5V$ ,  $R_{DT} = 200k$ ,  $ENA = ENC = H$ ,  $F_{PWMA} = 20kHz$ ,  $T_A = 25^\circ C$ ,  
 resistor + inductor load:  $5\Omega + 1mH$ /phase with star connection, unless otherwise noted.

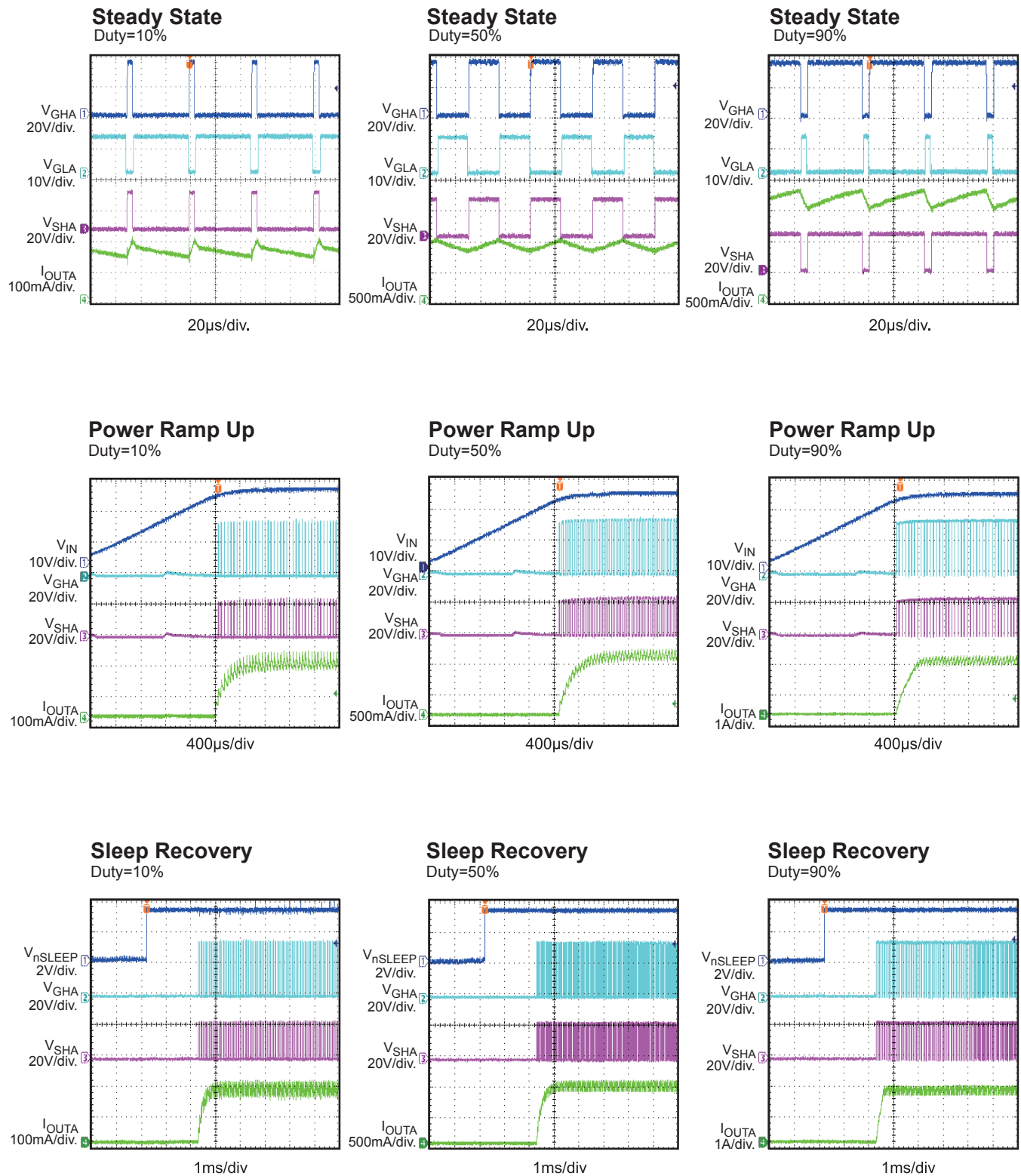

**TYPICAL PERFORMANCE CHARACTERISTICS (continued)**

$V_{IN} = 24V$ ,  $OC\_REF = 0.5V$ ,  $R_{DT} = 200k$ ,  $ENA = ENC = H$ ,  $F_{PWMA} = 20kHz$ ,  $T_A = 25^\circ C$ ,  
 resistor + inductor load:  $5\Omega + 1mH$ /phase with star connection, unless otherwise noted.

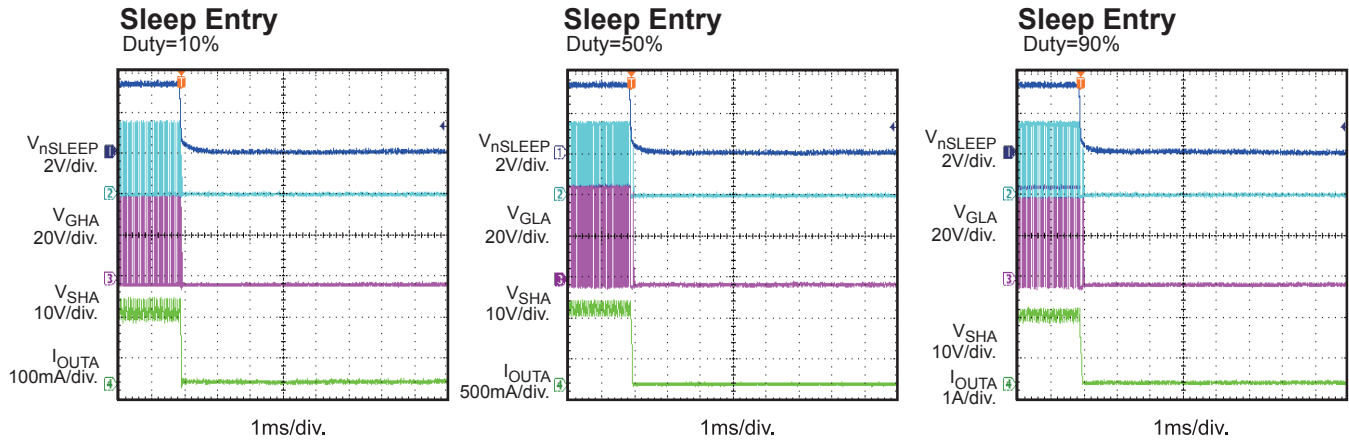



## PIN FUNCTIONS

QFN-28 Pin #	TSSOP-28 Pin #	Name	Description
1	26	VIN	<b>Input supply voltage.</b>
2	27	CPA	<b>Charge pump capacitor connect terminal.</b>
3	28	CPB	<b>Charge pump capacitor connect terminal.</b>
4	1	VREG	<b>Gate driver supply output.</b>
5	2	BSTA	<b>Bootstrap output phase A.</b>
6	3	SHA	<b>High-side source connection phase A.</b>
7	4	GHA	<b>High-side gate drive phase A.</b>
8	5	GLA	<b>Low-side gate drive phase A.</b>
9	6	BSTB	<b>Bootstrap output phase B.</b>
10	7	SHB	<b>High-side source connection phase B.</b>
11	8	GHB	<b>High-side gate drive phase B.</b>
12	9	GLB	<b>Low-side gate drive phase B.</b>
13	10	BSTC	<b>Bootstrap output phase C.</b>
14	11	SHC	<b>High-side source connection phase C.</b>
15	12	GHC	<b>High-side gate drive phase C.</b>
16	13	GLC	<b>Low-side gate drive phase C.</b>
17	14	LSS	<b>Low-side source connection.</b>
18	15	PWMC	<b>PWM input for phase C.</b>
19	16	PWMB	<b>PWM input for phase B.</b>
20	17	PWMA	<b>PWM input for phase A.</b>
21	18	ENC	<b>Enable for phase C.</b> Pull ENC below the specified threshold to disable the gate driver output for phase C.
22	19	ENB	<b>Enable for phase B.</b> Pull ENB below the specified threshold to disable the gate driver output for phase B.
23	20	ENA	<b>Enable for phase A.</b> Pull ENA below the specified threshold to disable the gate driver output for phase A.
24	21	nFAULT	<b>Fault indication.</b> Open-drain output. nFAULT is in a fault condition at logic low.
25	22	nSLEEP	<b>Sleep mode input.</b> nSLEEP is in low-power sleep mode at logic low. Float to enable.
26	23	OC_REF	<b>Over-current protection reference input.</b>
27	24	DT	<b>Dead time setting.</b>
28	25	GND	<b>Ground.</b>

BLOCK DIAGRAM

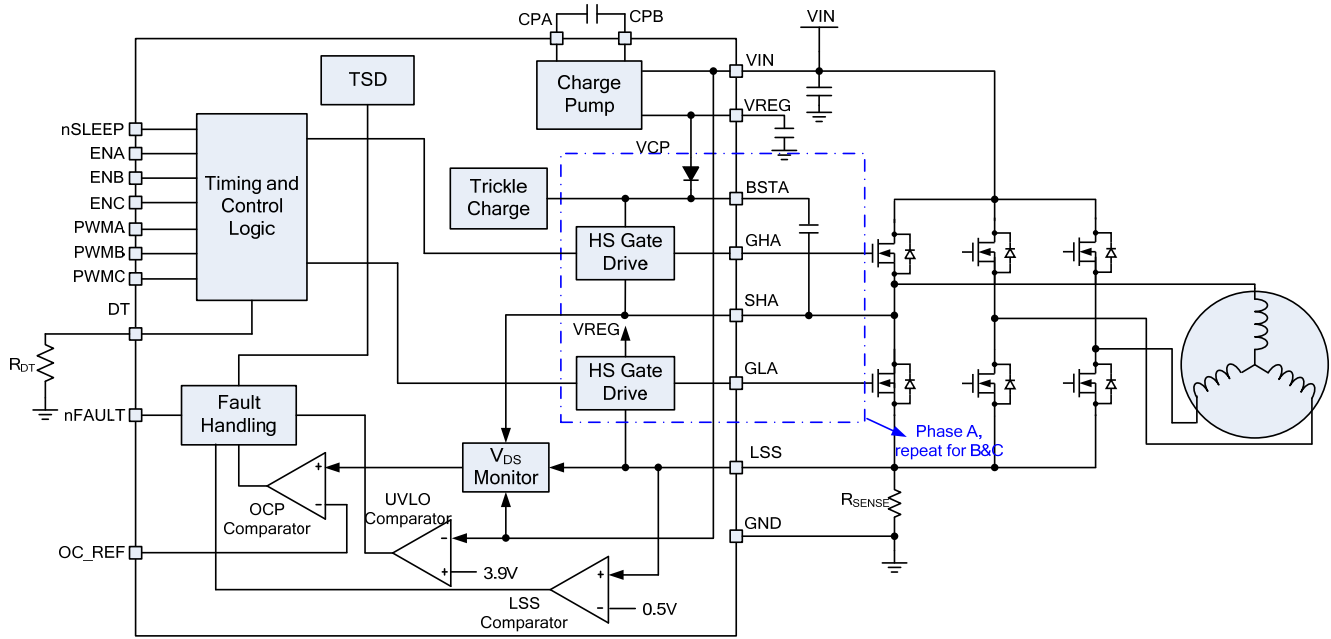

Figure 1: Functional Block Diagram

## OPERATION

The MP6529 is a three-phase, BLDC motor pre-driver that can drive three half-bridges with a 0.8A source and a 1A sink current capability over a wide input voltage range of 5V to 35V. It is designed for use in battery-powered equipment. The MP6529 features a low-power sleep mode, which disables the device and draws a very low supply current.

The MP6529 provides several flexible functions, such as adjustable dead-time control and over-current protection (OCP), which allow the device to cover a wide range of application fields.

### Input Logic

Drive nSLEEP low to put the device into a low-power sleep state. In this state, all of the internal circuits are disabled. When nSLEEP is in active low, all of the inputs are ignored. When exiting sleep mode, a brief time period of approximately 1ms must pass before issuing a PWM command. This time period allows the internal circuitry to stabilize.

ENx controls the gate driver outputs of this phase. When ENx is low, the gate driver outputs are disabled, and the PWM inputs are ignored. When ENx is high, the gate driver outputs are enabled, and the PWM inputs are recognized. Refer to Table 1 below for the logic truth table.

**Table 1: Input Logic Truth Table**

ENx	PWMx	SHx
H	H	VIN
H	L	GND
L	x	High impedance

### nFAULT

nFAULT reports to the system when a fault condition is detected, such as OCP and OTP. nFAULT can be an open-drain output, and is driven low once a fault condition occurs. If the fault condition is released, nFAULT is pulled high by an external pull-up resistor.

### Over-Current Protection (OCP)

The MP6529 implements VDS sensing circuitry to protect the power stage from damage caused by high currents. Based on the  $R_{DS-ON}$  of the power MOSFETs and the maximum allowed  $I_{DS}$ , a voltage threshold can be calculated, which

triggers the over-current protection (OCP) feature when exceeded.

This voltage threshold level is programmable through the OC\_REF terminal by applying an external reference voltage with a DAC. Also, OCP occurs if the LSS voltage exceeds 0.5V. Once an OCP event is detected, the MP6529 will enter a latched fault state and disable all functions. The MP6529 will stay latched off until it is reset by nSLEEP or UVLO.

### OCP Deglitch Time

Usually, a current spike occurs during the switching transition due to either the body diode's reverse-recovery current or the distributed inductance or capacitance. This current spike requires filtering to prevent it from erroneously triggering OCP and shutting down the external MOSFET. An internal fixed deglitch time ( $t_{OC}$ ) (which is also the minimum on time for the MOSFET) blanks the output of the VDS monitor when the outputs are switched.

### Dead-Time Adjustment

To prevent a shoot-through at any phase of the bridge, it is necessary to have a dead time ( $t_{DEAD}$ ) between a high- or low-side turn-off and the next complementary turn-on event. The dead time for all three phases is set by a single dead-time resistor ( $R_{DT}$ ) between DT and ground and is calculated with Equation (1):

$$t_{DEAD}(nS) = 3.7 * R(k\Omega) \quad (1)$$

If DT is tied to GND directly, an internal minimum dead time of 30ns is applied. Leaving DT open generates a 6µs dead time.

### Input UVLO Protection

If at any time the voltage on VIN falls below the under-voltage lockout threshold voltage, all circuitry in the device is disabled, and the internal logic resets. Operation resumes when VIN rises above the UVLO threshold.

### Thermal Shutdown

If the die temperature exceeds its safe limits, the MP6529 enters a latched fault-state similar to an OCP event, and nFAULT is driven low. Only a reset by nSLEEP or UVLO unlatches the device from an OTP fault lockout.

PACKAGE INFORMATION

QFN-28 (4mmx4mm)

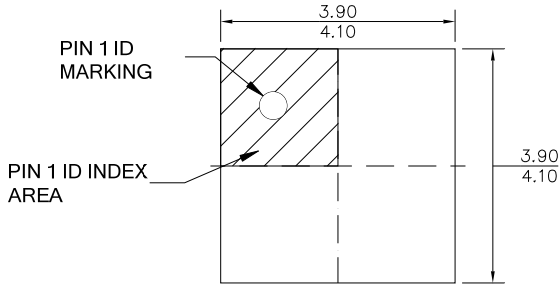

TOP VIEW

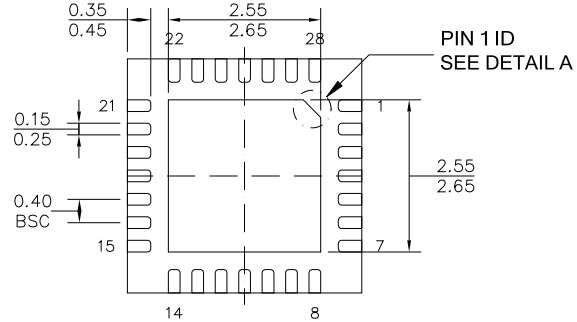

BOTTOM VIEW

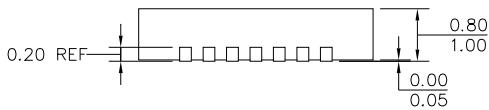

SIDE VIEW

PIN 1 ID OPTION A  
0.30x45° TYP.

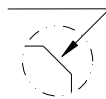

PIN 1 ID OPTION B  
R0.25 TYP.

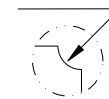

DETAIL A

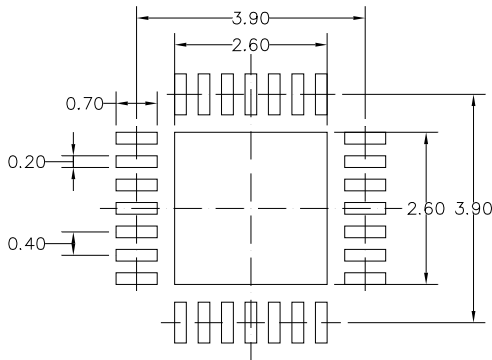

RECOMMENDED LAND PATTERN

NOTE:

- 1) ALL DIMENSIONS ARE IN MILLIMETERS.
- 2) EXPOSED PADDLE SIZE DOES NOT INCLUDE MOLD FLASH.
- 3) LEAD COPLANARITY SHALL BE 0.10 MILLIMETERS MAX.
- 4) DRAWING CONFORMS TO JEDEC MO-220.
- 5) DRAWING IS NOT TO SCALE.

## PACKAGE INFORMATION

### TSSOP-28 EP (9.7mmx6.4mm)

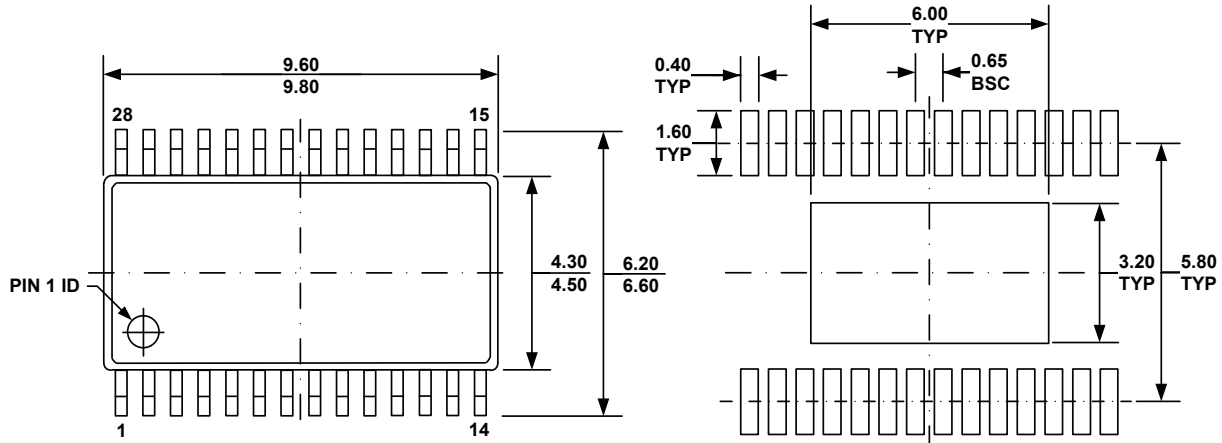

**TOP VIEW**

**RECOMMENDED LAND PATTERN**

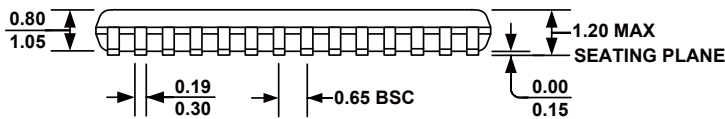

**FRONT VIEW**

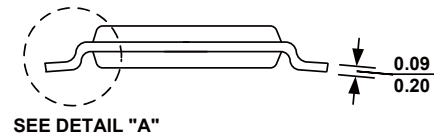

**SIDE VIEW**

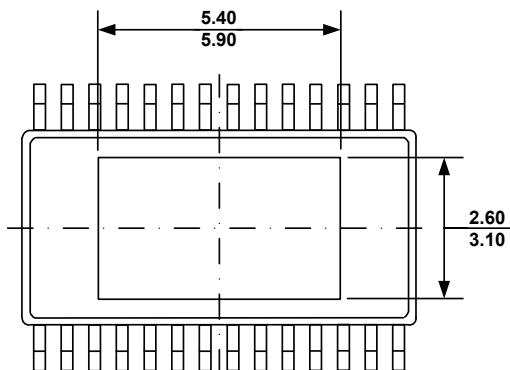

**BOTTOM VIEW**

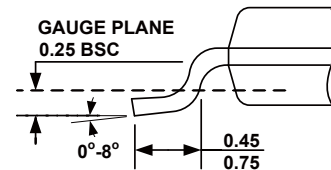

**DETAIL A**

**NOTE:**

- 1) ALL DIMENSIONS ARE IN MILLIMETERS.
- 2) PACKAGE LENGTH DOES NOT INCLUDE MOLD FLASH, PROTRUSION OR GATE BURR.
- 3) PACKAGE WIDTH DOES NOT INCLUDE INTERLEAD FLASH OR PROTRUSION.
- 4) LEAD COPLANARITY (BOTTOM OF LEADS AFTER FORMING) SHALL BE 0.10 MILLIMETERS MAX.
- 5) DRAWING CONFORMS TO JEDEC MO-153, VARIATION AET.
- 6) DRAWING IS NOT TO SCALE.

**NOTICE:** The information in this document is subject to change without notice. Please contact MPS for current specifications. Users should warrant and guarantee that third party Intellectual Property rights are not infringed upon when integrating MPS products into any application. MPS will not assume any legal responsibility for any said applications.

Компания «Океан Электроники» предлагает заключение долгосрочных отношений при поставках импортных электронных компонентов на взаимовыгодных условиях!

Наши преимущества:

- Поставка оригинальных импортных электронных компонентов напрямую с производств Америки, Европы и Азии, а так же с крупнейших складов мира;
- Широкая линейка поставок активных и пассивных импортных электронных компонентов (более 30 млн. наименований);
- Поставка сложных, дефицитных, либо снятых с производства позиций;
- Оперативные сроки поставки под заказ (от 5 рабочих дней);
- Экспресс доставка в любую точку России;
- Помощь Конструкторского Отдела и консультации квалифицированных инженеров;
- Техническая поддержка проекта, помощь в подборе аналогов, поставка прототипов;
- Поставка электронных компонентов под контролем ВП;
- Система менеджмента качества сертифицирована по Международному стандарту ISO 9001;
- При необходимости вся продукция военного и аэрокосмического назначения проходит испытания и сертификацию в лаборатории (по согласованию с заказчиком);
- Поставка специализированных компонентов военного и аэрокосмического уровня качества (Xilinx, Altera, Analog Devices, Intersil, Interpoint, Microsemi, Actel, Aeroflex, Peregrine, VPT, Syfer, Eurofarad, Texas Instruments, MS Kennedy, Miteq, Cobham, E2V, MA-COM, Hittite, Mini-Circuits, General Dynamics и др.);

Компания «Океан Электроники» является официальным дистрибьютором и эксклюзивным представителем в России одного из крупнейших производителей разъемов военного и аэрокосмического назначения «JONHON», а так же официальным дистрибьютором и эксклюзивным представителем в России производителя высокотехнологичных и надежных решений для передачи СВЧ сигналов «FORSTAR».



## JONHON

«JONHON» (основан в 1970 г.)

Разъемы специального, военного и аэрокосмического назначения:

(Применяются в военной, авиационной, аэрокосмической, морской, железнодорожной, горно- и нефтедобывающей отраслях промышленности)

«FORSTAR» (основан в 1998 г.)

ВЧ соединители, коаксиальные кабели, кабельные сборки и микроволновые компоненты:

(Применяются в телекоммуникациях гражданского и специального назначения, в средствах связи, РЛС, а так же военной, авиационной и аэрокосмической отраслях промышленности).



Телефон: 8 (812) 309-75-97 (многоканальный)

Факс: 8 (812) 320-03-32

Электронная почта: [ocean@oceanchips.ru](mailto:ocean@oceanchips.ru)

Web: <http://oceanchips.ru/>

Адрес: 198099, г. Санкт-Петербург, ул. Калинина, д. 2, корп. 4, лит. А