

PLC-RS.../21

PLC INTERFACE With PDT Relay, Universal Version

INTERFACE

Data Sheet
101780_en_02

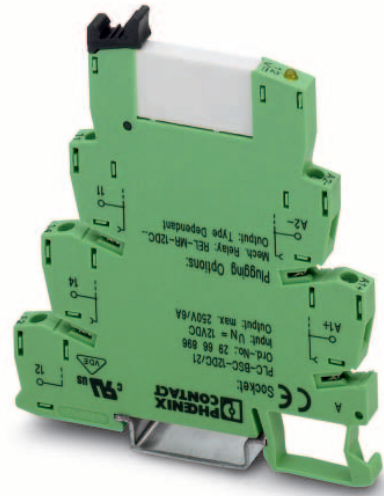

© PHOENIX CONTACT - 03/2008

1 Description

PLC-RS.../21 relay modules, which can be used universally, comprise 6.2 mm basic terminal blocks and plug-in miniature relays with PDT contact and screw or spring-cage connection.

1.1 PDT Offers a High Degree of Flexibility

The PLC-RS.../21 universal PDT module is used whenever an application requires a high degree of flexibility. It can be used either as an input or output module or in N/O, N/C or PDT contact applications.

This offers the advantage of fewer ordering and warehousing items. PLC INTERFACE modules are supplied fully equipped with a relay as standard.

1.2 Input Voltages From 12 V to 230 V

PLC-RS.../21 is available on the coil side in all common industrial voltages from 12 V to 230 V. A further advantage is the ready-integrated input circuit. It consists of a status indicator as well as free-wheeling diode and polarity reversal protection function, and ensures that the operating state is displayed clearly, also offering reliable EMI suppression for the coils and preventing destruction should the polarity be accidentally reversed.

1.3 Optimum Use of Plug-In Bridges

The PLC INTERFACE module achieves maximum efficiency with the user-friendly FBST plug-in bridge system. The PLC-RS.../21 makes effective use of the bridging options for the A1/A2 connection on the coil side and for the grouped power supply at connection 11 on the contact side. Especially effective here are the 500 mm long color-insulated continuous plug-in bridges that can easily be cut to the required length and quickly inserted in the bridge shafts. They eliminate the need for complicated and time-consuming loop bridges.

1.4 Additional Advantages

- Operational safety with RT III (IP67)-protected mechanics
- Environmentally friendly, cadmium-free power contact material for loads up to 250 V AC/6 A
- Available with gold coating for low power levels (mA) as an option
- Integrated input circuit
- Relay can be replaced using an engagement lever
- Safe isolation according to DIN EN 50178
- Inflammability class V0 according to UL94





Make sure you always use the latest documentation.
It can be downloaded at www.download.phoenixcontact.com.
A conversion table is available on the Internet at
www.download.phoenixcontact.com/general/7000_en_00.pdf.



This data sheet is valid for all products listed on the following page:



2 Ordering Data

PLC INTERFACE With Screw Connection

Description	Type	Order No.	Pcs./Pck.	
PLC INTERFACE With Multi-Layer Contact Relay, Universal Version				
PLC INTERFACE, comprising PLC-BSC.../21 basic terminal block and plug-in miniature relay (see INTERFACE catalog), for mounting on 	12 V DC	PLCRSC- 12DC/21AU	2966919	10
	24 V DC	PLCRSC- 24DC/21AU	2966265	10
	24 V AC/DC	PLCRSC- 24UC/21AU	2966278	10
	48 V DC	PLCRSC- 48DC/21AU	2966126	10
	60 V DC	PLCRSC- 60DC/21AU	2966142	10
	120 V AC/110 V DC	PLCRSC-120UC/21AU	2966281	10
	230 V AC/220 V DC ¹	PLCRSC-230UC/21AU	2966294	10
PLC INTERFACE With Power Contact Relay, Universal Version				
PLC INTERFACE, comprising PLC-BSC.../21 basic terminal block and plug-in miniature relay (see INTERFACE catalog), for mounting on 	12 V DC	PLCRSC- 12DC/21	2966906	10
	24 V DC	PLCRSC- 24DC/21	2966171	10
	24 V AC/DC	PLCRSC- 24UC/21	2966184	10
	48 V DC	PLCRSC- 48DC/21	2966113	10
	60 V DC	PLCRSC- 60DC/21	2966139	10
	120 V AC/110 V DC	PLCRSC-120UC/21	2966197	10
	230 V AC/220 V DC ¹	PLCRSC-230UC/21	2966207	10

¹ The PLC-ATP BK insulating plate must be installed for voltages greater than 250 V (L1, L2, L3) between the same terminal points on adjacent modules (see "Accessories"). FBST 8-PLC... or FBST 500... is then used for potential bridging.

PLC INTERFACE With Spring-Cage Connection

Description	Type	Order No.	Pcs./Pck.	
PLC INTERFACE With Multi-Layer Contact Relay, Universal Version				
PLC INTERFACE, comprising PLC-BSC.../21 basic terminal block and plug-in miniature relay (see INTERFACE catalog), for mounting on 	12 V DC	PLCRSP- 12DC/21AU	2967442	10
	24 V DC	PLCRSP- 24DC/21AU	2966540	10
	24 V AC/DC	PLCRSP- 24UC/21AU	2966553	10
	48 V DC	PLCRSP- 48DC/21AU	2966566	10
	60 V DC	PLCRSP- 60DC/21AU	2966579	10
	120 V AC/110 V DC	PLCRSP-120UC/21AU	2966582	10
	230 V AC/220 V DC ¹	PLCRSP-230UC/21AU	2966647	10
PLC INTERFACE With Power Contact Relay, Universal Version				
PLC INTERFACE, comprising PLC-BSC.../21 basic terminal block and plug-in miniature relay (see INTERFACE catalog), for mounting on 	12 V DC	PLCRSP- 12DC/21	2967439	10
	24 V DC	PLCRSP- 24DC/21	2966472	10
	24 V AC/DC	PLCRSP- 24UC/21	2966485	10
	48 V DC	PLCRSP- 48DC/21	2966498	10
	60 V DC	PLCRSP- 60DC/21	2966511	10
	120 V AC/110 V DC	PLCRSP-120UC/21	2966524	10
	230 V AC/220 V DC ¹	PLCRSP-230UC/21	2966537	10

¹ The PLC-ATP BK insulating plate must be installed for voltages greater than 250 V (L1, L2, L3) between the same terminal points on adjacent modules (see "Accessories"). FBST 8-PLC... or FBST 500... is then used for potential bridging.



With the 120 V and 230 V modules, an REL-MR-60DC/... 60 V relay is normally used due to the input circuit integrated in the basic terminal block. For the protection of input and output, inductive loads must be dampened with an effective protective circuit.

Accessories

Description	Type	Order No.	Pcs./Pck.
Insulating plate	PLC-ATP BK	2966841	25



The PLC-ATP BK insulating plate should be used in the following cases: always fit at the start and end of a PLC terminal strip for voltages greater than 250 V (L1, L2, L3) between the same terminal points on adjacent modules (FBST 8-PLC... or FBST 500... can be used for potential bridging) and for safe isolation between adjacent modules.

For additional accessories such as power terminal blocks and plug-in bridges, please refer to the INTERFACE catalog or www.phoenixcontact.com.

3 Technical Data

Input Data	...24DC...	...24UC...	...120UC...	...230UC...
Nominal input voltage ¹	24 V DC	24 V AC/DC	120 V AC/ 110 V DC	230 V AC/ 220 V DC
Permissible range (with reference to U _N)	See "Operating Voltage Ranges" on page 5			
Typical input current at U _N	9 mA	11 mA/8.5 mA	3.5 mA/3 mA	3 mA
Typical response time at U _N	4 ms	6 ms	6 ms	7 ms
Typical release time at U _N	8 ms	15 ms	15 ms	15 ms
Input circuit	Yellow LED, protection against polarity reversal, free- wheeling diode	Yellow LED, bridge rectifier		

¹ The PLC-ATP BK insulating plate must be installed for voltages greater than 250 V (L1, L2, L3) between the same terminal points on adjacent modules (see "Accessories"). FBST 8-PLC... or FBST 500... is then used for potential bridging.

Output Data	PLC-...21	PLC-...21AU	
Contact type	Single contact, SPDT		
Contact material	AgSnO	AgSnO + 5 μA ¹	
Maximum switching voltage	250 V AC/DC ²	30 V AC/36 V DC	
Minimum switching voltage	12 V AC/DC	100 mV	
Limiting continuous current	6 A	50 mA	
Maximum inrush current	30 A (for AC 15 operation)	50 mA	
Minimum switching current	10 mA	1 mA	
Maximum shutdown power	Ohmic load τ = 0 ms	Ohmic load τ = 0 ms	
	24 V DC	140 W	1.2 W
	48 V DC	20 W	-
	60 V DC	18 W	-
	110 V DC	23 W	-
	220 V DC	40 W	-
250 V AC	1500 VA	-	
Minimum switching power	120 mW	10 μW	

¹ If the specified maximum values are exceeded, the gold coating will be damaged. In subsequent operation, the AgSnO contact values given here will apply. This can then result in reduced service life, similar to dedicated power contacts.

² The PLC-ATP BK insulating plate must be installed for voltages greater than 250 V (L1, L2, L3) between the same terminal points on adjacent modules (see "Accessories"). FBST 8-PLC... or FBST 500... is then used for potential bridging.

General Data

Impulse voltage withstand level	4 kV, 50 Hz, 1 min.
Ambient temperature range	
Operation	-25°C ... 60°C (230 V type -25°C ... 55°C)
Storage/transport	-40°C ... 85°C
Nominal operating mode	100% operating factor
Inflammability class according to UL 94 (housing)	V0
Mechanical service life	2 x 10 ⁷ cycles

General Data (Continued)

Air and creepage distances between the circuits ¹	IEC 60664, IEC 60664 A, DIN VDE 0110, DIN EN 50178/VDE 0106-160, IEC 60255/DIN VDE 0435
Pollution degree	3
Surge voltage category	III
Mounting position	Any
Mounting	Can be aligned without spacing
Conductor cross-section	
Solid, with screw connection	0.14 mm ² ... 2.5 mm ² (26 - 14 AWG)
Stranded, with screw connection	0.14 mm ² ... 1.5 mm ² (26 - 14 AWG)
Solid, with spring-cage connection	0.2 mm ² ... 2.5 mm ² (24 - 14 AWG)
Stranded, with spring-cage connection	0.2 mm ² ... 1.5 mm ² (24 - 14 AWG)
Stripping length	
Screw connection	10 mm
Spring-cage connection	8 mm
Dimensions (W x H x D)	6.2 mm x 94 mm x 80 mm
Housing material	Polyamide PA, green

¹ The PLC-ATP BK insulating plate must be installed for safe isolation between adjacent modules (see "Accessories"). FBST 8-PLC... or FBST 500... is then used for potential bridging.

Tests/Approvals

CE	CE
UL	UL [®] cUL [®] US
GL	GL

4 Block Diagram

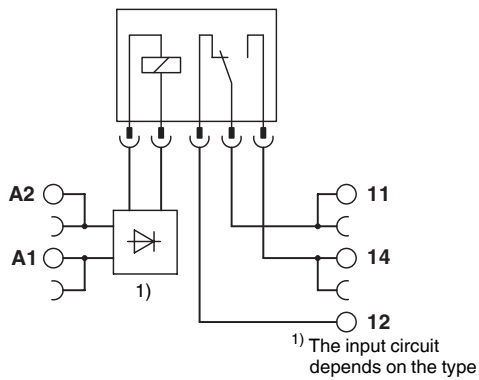

5 Operating Voltage Ranges

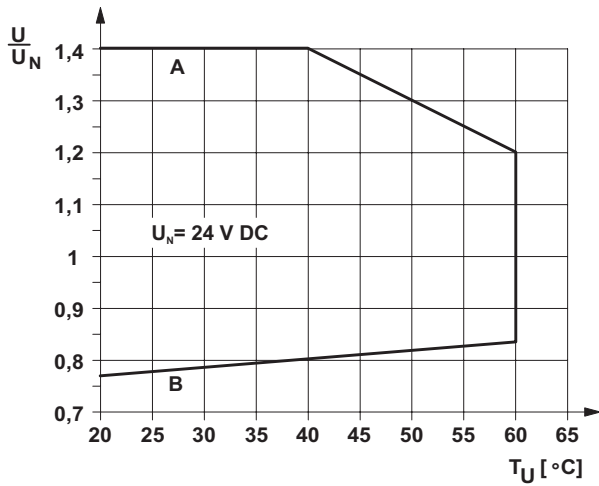

Figure 1 Operating voltage range for 24 V DC

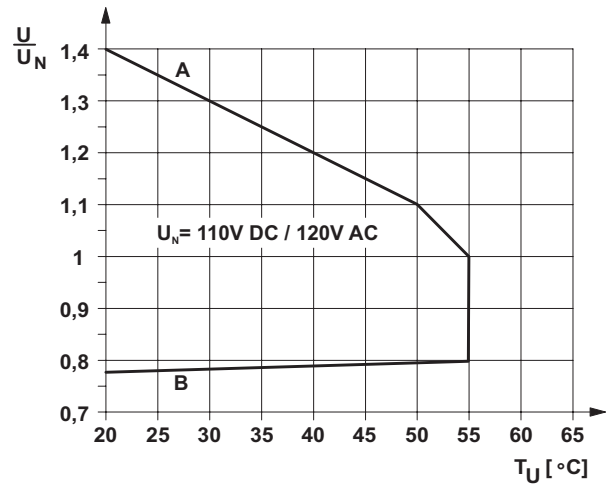

Figure 3 Operating voltage range for 120 V AC/DC

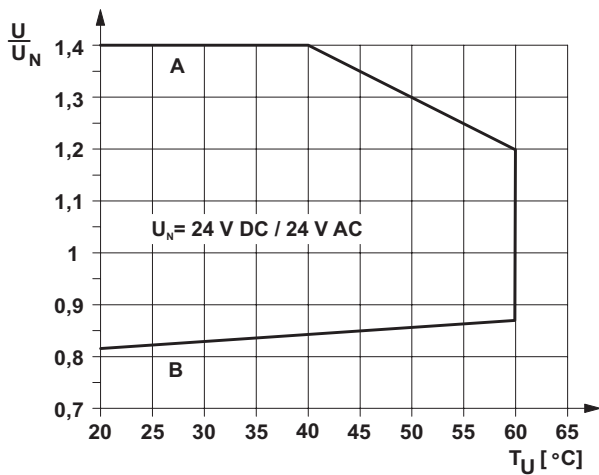

Figure 2 Operating voltage range for 24 V AC/DC

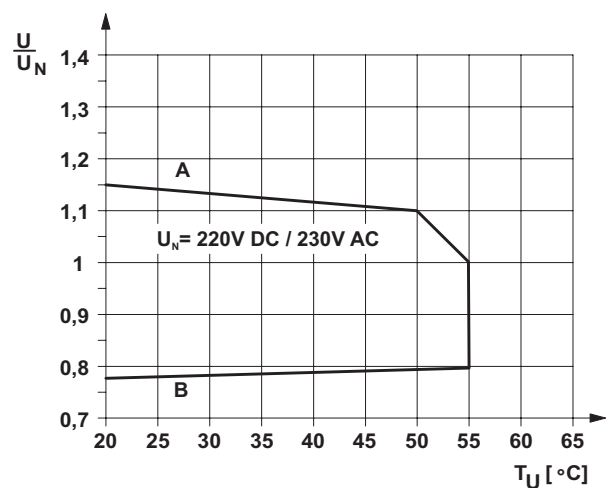

Figure 4 Operating voltage range for 230 V AC/DC

General Conditions

Direct alignment in the block, all devices 100% operating factor, horizontal or vertical mounting.

Curve A

Maximum permissible continuous voltage U_{max} with limiting continuous current on the contact side

Curve B

Minimum permissible operate voltage U_{op} following pre-excitation

Компания «Океан Электроники» предлагает заключение долгосрочных отношений при поставках импортных электронных компонентов на взаимовыгодных условиях!

Наши преимущества:

- Поставка оригинальных импортных электронных компонентов напрямую с производств Америки, Европы и Азии, а так же с крупнейших складов мира;
- Широкая линейка поставок активных и пассивных импортных электронных компонентов (более 30 млн. наименований);
- Поставка сложных, дефицитных, либо снятых с производства позиций;
- Оперативные сроки поставки под заказ (от 5 рабочих дней);
- Экспресс доставка в любую точку России;
- Помощь Конструкторского Отдела и консультации квалифицированных инженеров;
- Техническая поддержка проекта, помощь в подборе аналогов, поставка прототипов;
- Поставка электронных компонентов под контролем ВП;
- Система менеджмента качества сертифицирована по Международному стандарту ISO 9001;
- При необходимости вся продукция военного и аэрокосмического назначения проходит испытания и сертификацию в лаборатории (по согласованию с заказчиком);
- Поставка специализированных компонентов военного и аэрокосмического уровня качества (Xilinx, Altera, Analog Devices, Intersil, Interpoint, Microsemi, Actel, Aeroflex, Peregrine, VPT, Syfer, Eurofarad, Texas Instruments, MS Kennedy, Miteq, Cobham, E2V, MA-COM, Hittite, Mini-Circuits, General Dynamics и др.);

Компания «Океан Электроники» является официальным дистрибьютором и эксклюзивным представителем в России одного из крупнейших производителей разъемов военного и аэрокосмического назначения «**JONHON**», а так же официальным дистрибьютором и эксклюзивным представителем в России производителя высокотехнологичных и надежных решений для передачи СВЧ сигналов «**FORSTAR**».



JONHON

«**JONHON**» (основан в 1970 г.)

Разъемы специального, военного и аэрокосмического назначения:

(Применяются в военной, авиационной, аэрокосмической, морской, железнодорожной, горно- и нефтедобывающей отраслях промышленности)

«**FORSTAR**» (основан в 1998 г.)

ВЧ соединители, коаксиальные кабели,
кабельные сборки и микроволновые компоненты:

(Применяются в телекоммуникациях гражданского и специального назначения, в средствах связи, РЛС, а так же военной, авиационной и аэрокосмической отраслях промышленности).



Телефон: 8 (812) 309-75-97 (многоканальный)

Факс: 8 (812) 320-03-32

Электронная почта: ocean@oceanchips.ru

Web: <http://oceanchips.ru/>

Адрес: 198099, г. Санкт-Петербург, ул. Калинина, д. 2, корп. 4, лит. А