

Power Management IC Series for Automotive Body Control

High Voltage LDO Regulators



BD3570FP, BD3570HFP, BD3571FP, BD3571HFP, BD3572FP, BD3572HFP
BD3573FP, BD3573HFP, BD3574FP, BD3574HFP, BD3575FP, BD3575HFP

No.11036EBT02

●Description

BD357XFP/HFP SERIES regulators feature a high 50 V withstand-voltage and are suitable for use with onboard vehicle microcontrollers. They offer the output current of 500 mA while limiting the quiescent current to 30 μ A (TYP). With these devices, a ceramic capacitor can be selected at the output for stable operation, the output tolerance is within $\pm 2\%$ over the wide ambient temperature range (-40 to 125°C), and the short circuit protection is folded-type to minimize generation of heat during malfunction. These devices are developed to offer most robust power-supply design under the harsh automotive environment. The BD357XFP/HFP Series provide ideal solutions to lower the current consumption as well as to simplify the use with battery direct-coupled systems.

●Features

- 1) Ultra-low quiescent current: 30 μ A (TYP.)
- 2) Low-saturation voltage type P-channel DMOS output transistors
- 3) High output voltage precision: $\pm 2\%$ / I_{omax} = 500 mA
- 4) Low-ESR ceramic capacitors can be used as output capacitors.
- 5) V_{cc} power supply voltage = 50 V
- 6) Built-in overcurrent protection circuit and thermal shutdown circuit
- 7) TO252-3, TO252-5, HRP5 Package

●Applications

Onboard vehicle devices (body-control, car stereos, satellite navigation systems, etc.)

●Line up matrix

	BD3570FP/HFP	BD3571FP/HFP	BD3572FP/HFP	BD3573FP/HFP	BD3574FP/HFP	BD3575FP/HFP
Output voltage	3.3V	5.0 V	Variable	3.3V	5.0 V	Variable
SW function	—	—	—	○	○	○

Package FP:TO252-3,TO252-5
HFP:HRP5

●Absolute maximum ratings (T_a=25°C)

Parameter	Symbol	Limit	Unit
Supply voltage	V _{cc}	50 ※1	V
Switch Supply voltage	V _{sw}	50 ※2	V
Output current	I _o	500	mA
Power dissipation	P _d	1.2 (TO252-3) ※3	W
		1.3 (TO252-5) ※4	
		1.6 (HRP5) ※5	
Operating temperature range	T _{opr}	-40 to +125	°C
Storage temperature range	T _{stg}	-55 to +150	°C
Maximum junction temperature	T _{jmax}	150	°C

※1 Not to exceed P_d and ASO.

※2 for ON/OFF SW Regulator only

※3 TO252-3: Reduced by 9.6 mW/°C over 25 °C, when mounted on a glass epoxy board (70 mm × 70 mm × 1.6 mm).

※4 TO252-5: Reduced by 10.4 mW/°C over 25 °C, when mounted on a glass epoxy board (70 mm × 70 mm × 1.6 mm).

※5 HRP5: Reduced by 12.8 mW/°C over 25 °C, when mounted on a glass epoxy board (70 mm × 70 mm × 1.6 mm).

●Operating Conditions

Parameter		Symbol	Min.	Max.	Unit
Input voltage	BD3570,3572,3573,3575FP/HFP	Vcc	4.5 ※6	36.0	V
	BD3571,3574FP/HFP	Vcc	5.5 ※6	36.0	V
Output current		Io	—	500	mA
Variable Output Voltage Range		Vo	2.8	12	V

※6 Please consider that the Output voltage would be dropped (Dropout voltage) according to the output current.

●Electrical Characteristics (Unless otherwise specified, Ta=-40 to125°C, Vcc=13.2 V, SW=3V ※7, Vo settings is 5V ※8)

Parameter	Symbol	Limit			Unit	Conditions
		Min.	Typ.	Max.		
Shut Down Current ※7	Ishut	—	—	10	μA	SW=GND
Bias current	Ib	—	30	50	μA	Io=0mA
Output voltage	Vo	Vo × 0.98	Vo	Vo × 1.02	V	Io=200mA, Vo:Please refer to Product line.
ADJ Terminal voltage ※8	VADJ	1.235	1.260	1.285	V	Io=200mA
Output current	Io	0.5	—	—	A	
Dropout voltage	ΔVd	—	0.25	0.48	V	Vcc=4.75V,Io=200mA ※9
Ripple rejection	R.R.	45	55	—	dB	f=120Hz,ein=1Vrms,Io=100mA
Line Regulation	Reg.I	—	10	30	mV	VCCD※10 ≤ Vcc ≤ 25V Io = 0 mA
Load Regulation	Reg.L	—	20	40	mV	0mA ≤ Io ≤ 200mA
Swith Threshold voltage H ※7	SWH	2.0	—	—	V	Io=0 mA
Swith Threshold voltage L ※7	SWL	—	—	0.5	V	Io=0 mA
Swith Bias current ※7	SWI	—	22	60	μA	SW=5V,Io=0mA

※7 BD3573,3574,3575FP/HFP only

※8 BD3572,3575FP/HFP only

※9 BD3571,3572,3574,3575FP/HFP only

※10 BD3570,3573FP/HFP :VCCD=5.5V

BD3571,3572,3574,3575FP/HFP :VCCD=6.5V

○This product is not designed for protection against radio active rays.

● Reference Data: BD3574HFP (Unless otherwise specified, $T_a=25^\circ\text{C}$)

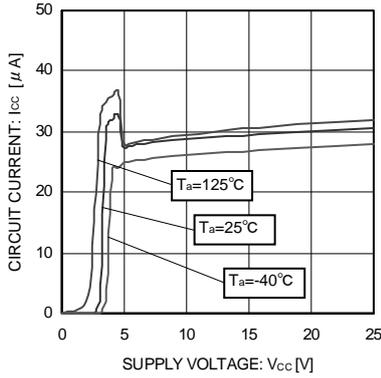

Fig. 1 Total Supply Current

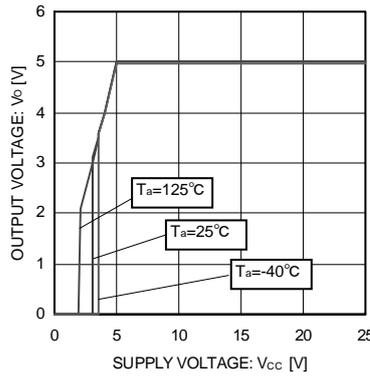

Fig. 2 Output Voltage VS Power Supply Voltage

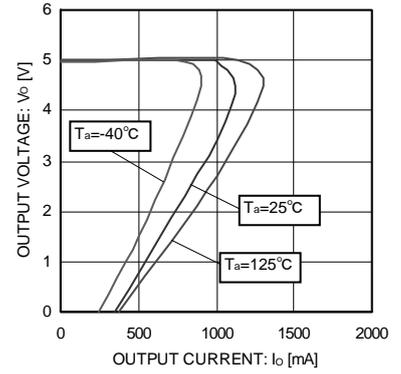

Fig. 3 Output Voltage VS Load

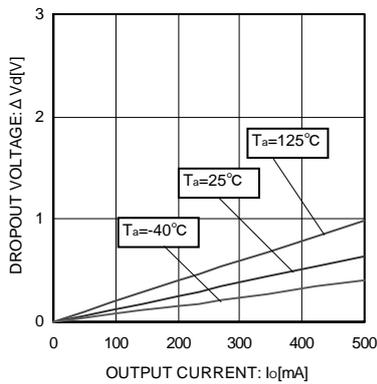

Fig. 4 Dropout Voltage

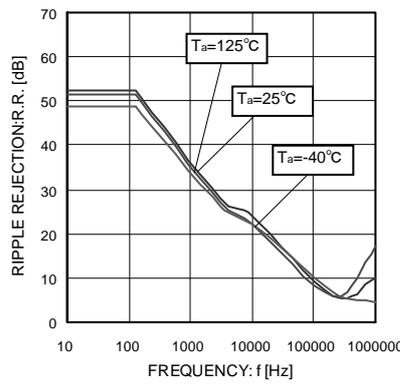

Fig. 5 Ripple rejection

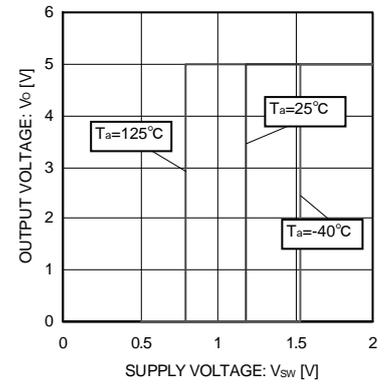

Fig. 6 Output Voltage VS SW Input Voltage

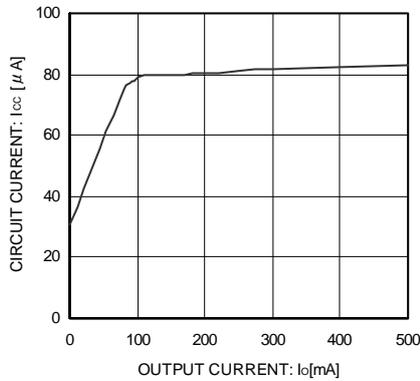

Fig. 7 Total Supply Current Classified by Load

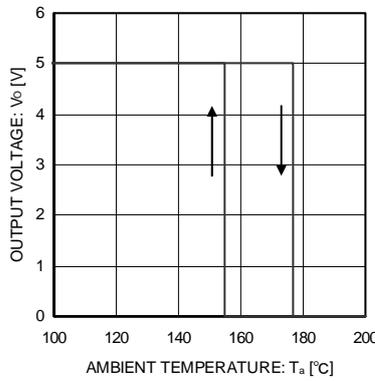

Fig. 8 Thermal Shutdown Circuit

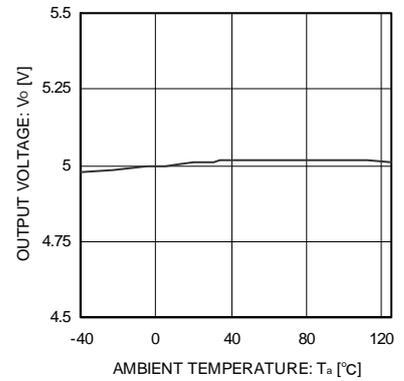

Fig. 9 Output Voltage VS Temperature

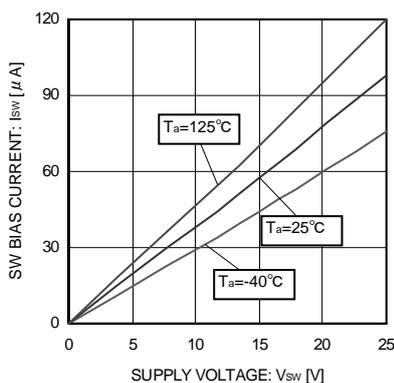

Fig. 10 SW Bias current

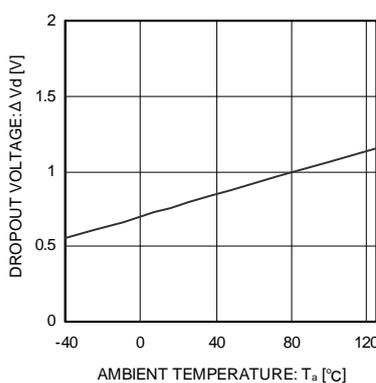

Fig. 11 Dropout voltage VS Temperature

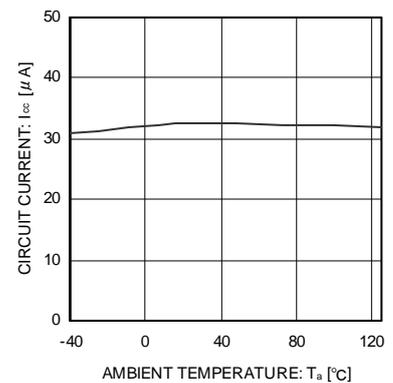

Fig. 12 Total Supply Current Temperature

●Block Diagram

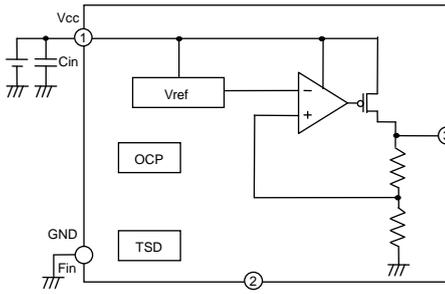

Fig.13 TO252-3

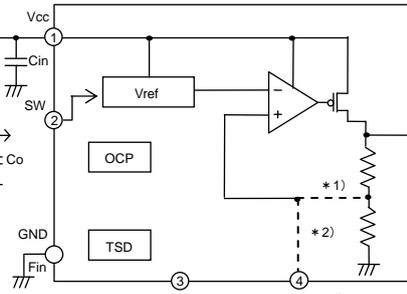

Fig.14 TO252-5

Cin : 0.33 μ F ~ 1000 μ F
Co : 0.1 μ F ~ 1000 μ F

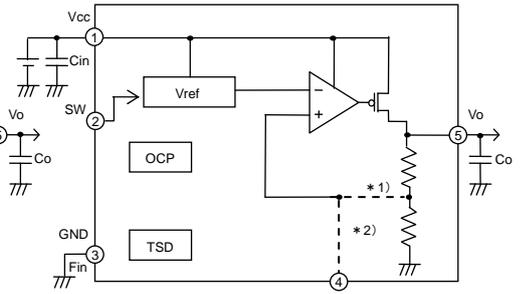

Fig.15 HRP5

* 1) For Fixed Voltage Regulator only
* 2) For adjustable Voltage Regulator only

●I/O Circuit diagram (All resistance values are typical.)

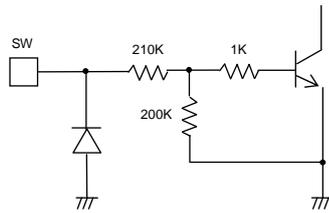

Fig.16 2PIN[SW]

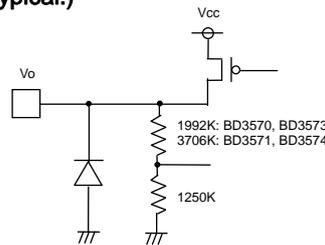

Fig.17 5PIN[Vo]
BD3570,3571,3573,3574

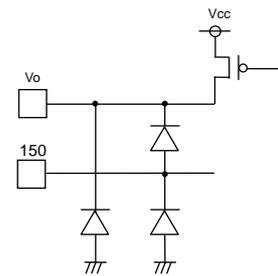

Fig.18 4.5PIN[ADJ,Vo]
BD3572,BD3575

●Pin Assignments

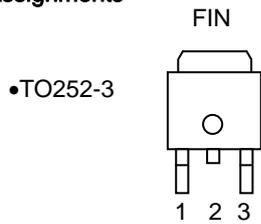

Fig. 19

Pin No.	Pin name	Function
1	Vcc	Power supply pin
2	N.C.	N.C. pin
3	Vo	Voltage output pin
Fin	GND	GND pin

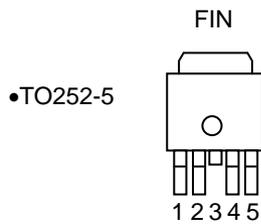

Fig.20

Pin No.	Pin name	Function
1	Vcc	Power supply pin
2	SW N.C.	Vo ON/OFF function pin N.C. pin(BD3572FP only)
3	N.C.	N.C. pin
4	N.C. ADJ	N.C. pin Output voltage setting pin(BD3572,3575FP only)
5	Vo	Voltage output pin
Fin	GND	GND pin

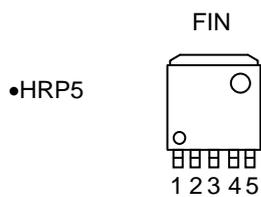

Fig. 21

Pin No.	Pin name	Function
1	Vcc	Power supply pin
2	SW N.C.	Vo ON/OFF function pin (BD3573,3574,3575HFP only) N.C. pin
3	GND	GND pin
4	N.C. ADJ	N.C. pin Output voltage setting pin(BD3572,3575HFP only)
5	Vo	Voltage output pin
Fin	GND	GND pin

●Output Voltage Adjustment

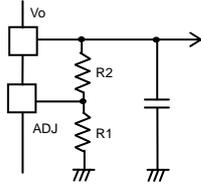

Fig.22

To set the output voltage insert pull-down resistor R1 between the ADJ and GND pins, and pull-up resistor R2 between the Vo and ADJ pins.

$$V_o = V_{ADJ} \times (R_1 + R_2) / R_1 [V]$$

{V_{ADJ}=1.26V(TYP.)}

The recommended connection resistor for the ADJ-GND is 30k~150kΩ.

●Setting of Heat

TO252-3

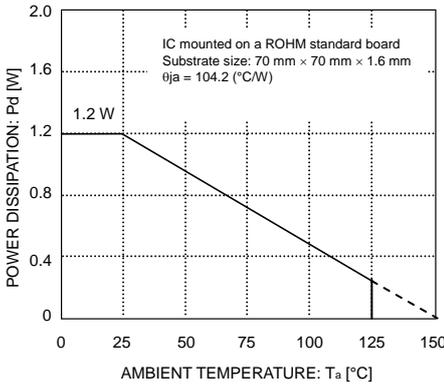

Fig. 23

TO252-5

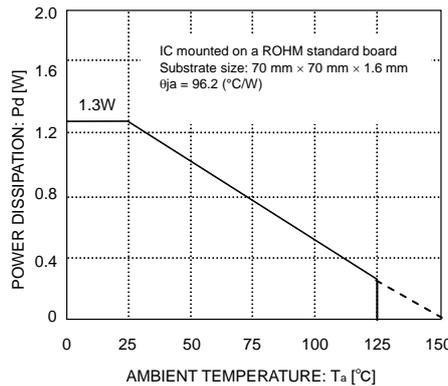

Fig. 24

HRP5

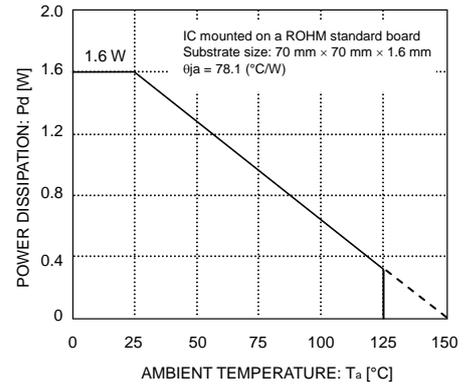

Fig. 25

Refer to the heat mitigation characteristics illustrated in Figs. 23, 24 and 25 when using the IC in an environment where $T_a \geq 25^\circ\text{C}$. The characteristics of the IC are greatly influenced by the operating temperature. If the temperature is in excess of the maximum junction temperature T_{jmax} , the elements of the IC may be deteriorated or damaged. It is necessary to give sufficient consideration to the heat of the IC in view of two points, i.e., the protection of the IC from instantaneous damage and the maintenance of the reliability of the IC in long-time operation.

In order to protect the IC from thermal destruction, it is necessary to operate the IC not in excess of the maximum junction temperature T_{jmax} . Fig. 23 illustrates the power dissipation/heat mitigation characteristics for the TO252 package. Operate the IC within the power dissipation P_d . The following method is used to calculate the power consumption P_c (W).

$$P_c = (V_{cc} - V_o) \times I_o + V_{cc} \times I_{cc}$$

Power dissipation $P_d \leq P_c$

V_{cc} : Input voltage
 V_o : Output voltage
 I_o : Load current
 I_{cc} : Total supply current

The load current I_o is obtained to operate the IC within the power dissipation.

$$I_o \leq \frac{P_d - V_{cc} \times I_{cc}}{V_{cc} - V_o} \quad (\text{For more information about } I_{cc}, \text{ see page 12.})$$

The maximum load current I_{omax} for the applied voltage V_{cc} can be calculated during the thermal design process.

●Calculation example

Example: BD3571FP $V_{cc} = 12\text{ V}$ and $V_o = 5\text{ V}$ at $T_a = 85^\circ\text{C}$

$$I_o \leq \frac{0.624 - 12 \times I_{cc}}{12 - 5}$$

$$I_o \leq 89\text{mA} \quad (I_{cc} = 30\ \mu\text{A})$$

$\left(\begin{array}{l} \theta_{ja} = 104.2^\circ\text{C/W} \rightarrow 9.6\text{mAW}/^\circ\text{C} \\ 25^\circ\text{C} = 1.2\text{W} \rightarrow 85^\circ\text{C} = 0.624\text{W} \end{array} \right)$

Make a thermal calculation in consideration of the above so that the whole operating temperature range will be within the power dissipation.

The power consumption P_c of the IC in the event of shorting (i.e., if the V_o and GND pins are shorted) will be obtained from the following equation.

$$P_c = V_{cc} \times (I_{cc} + I_{short}) \quad I_{short} = \text{Short current}$$

●Peripheral Settings for Pins and Precautions

- 1) Vcc pins
Insert capacitors with a capacitance of $0.33 \mu\text{F}$ to $1000 \mu\text{F}$ between the Vcc and GND pins.
The capacitance varies with the application. Be sure to design the capacitance with a sufficient margin.
- 2) Capacitors for stopping oscillation for output pins
Capacitors for stopping oscillation must be placed between each output pin and the GND pin. Use a capacitor within a capacitance range between $0.1 \mu\text{F}$ and $1000 \mu\text{F}$. Since oscillation does not occur even for ESR values from 0.001Ω to 100Ω , a ceramic capacitor can be used. Abrupt input voltage and load fluctuations can affect output voltages. Output capacitor capacitance values should be determined after sufficient testing of the actual application.

●Operation Notes

- 1) Absolute maximum ratings
Use of the IC in excess of absolute maximum ratings such as the applied voltage or operating temperature range may result in IC damage. Assumptions should not be made regarding the state of the IC (short mode or open mode) when such damage is suffered. A physical safety measure such as a fuse should be implemented when use of the IC in a special mode where the absolute maximum ratings may be exceeded is anticipated.
- 2) GND potential
Ensure a minimum GND pin potential in all operating conditions.
- 3) Setting of heat
Use a thermal design that allows for a sufficient margin in light of the power dissipation (Pd) in actual operating conditions.
- 4) Pin short and mistake fitting
Use caution when orienting and positioning the IC for mounting on printed circuit boards. Improper mounting may result in damage to the IC. Shorts between output pins or between output pins and the power supply and GND pins caused by the presence of a foreign object may result in damage to the IC.
- 5) Actions in strong magnetic field
Use caution when using the IC in the presence of a strong magnetic field as doing so may cause the IC to malfunction.
- 6) Testing on application boards
When testing the IC on an application board, connecting a capacitor to a pin with low impedance subjects the IC to stress. Always discharge capacitors after each process or step. Be sure to turn power off when mounting or dismounting jigs at the inspection stage. Furthermore, for countermeasures against static electricity, ground the equipment at the assembling stage and pay utmost attention at the time of transportation or storing the product.
- 7) This monolithic IC contains P+ isolation and P substrate layers between adjacent elements in order to keep them isolated. PN junction is formed by the P layer and the N layer of each element, and a variety of parasitic elements will be constituted.
For example, when a resistor and transistor are connected to pins as shown in Fig. 19,
 - the P/N junction functions as a parasitic diode when GND > Pin A for the resistor or GND > Pin B for the transistor (NPN).
 - Similarly, when GND > Pin B for the transistor (NPN), the parasitic diode described above combines with the N layer of other adjacent elements to operate as a parasitic NPN transistor.

The formation of parasitic elements as a result of the relationships of the potentials of different pins is an inevitable result of the IC's architecture. The operation of parasitic elements can cause interference with circuit operation as well as IC malfunction and damage. For these reasons, it is necessary to use caution so that the IC is not used in a way that will trigger the operation of parasitic elements, such as by the application of voltages lower than the GND (P substrate) voltage to input pins.

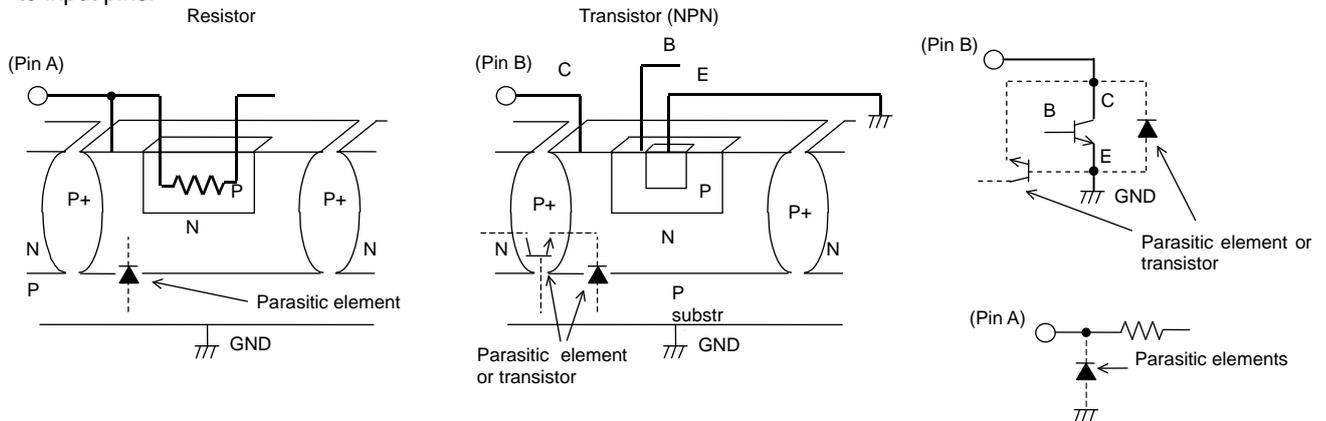

Fig. 26 Example of a Simple Monolithic IC Architecture

8) Ground wiring patterns

When using both small signal and large current GND patterns, it is recommended to isolate the two ground patterns, placing a single ground point at the application's reference point so that the pattern wiring resistance and voltage variations caused by large currents do not cause variations in the small signal ground voltage. Be careful not to change the GND wiring pattern of any external parts, either.

9) SW Pin

Do not apply the voltage to SW pin when the VCC is not applied.
And when the VCC is applied, the voltage of SW pin must not exceed VCC.

10) Thermal shutdown circuit (TSD)

This IC incorporates a built-in thermal shutdown circuit for the protection from thermal destruction. The IC should be used within the specified power dissipation range. However, in the event that the IC continues to be operated in excess of its power dissipation limits, the attendant rise in the chip's temperature T_j will trigger the thermal shutdown circuit to turn off all output power elements. The circuit automatically resets once the chip's temperature T_j drops.

The thermal shutdown circuit operates if the IC is under conditions in excess of the absolute maximum ratings. Never design sets on the premise of using the thermal shutdown circuit. (See Fig. 8)

11) Overcurrent protection circuit (OCP)

The IC incorporates a built-in overcurrent protection circuit that operates according to the output current capacity. This circuit serves to protect the IC from damage when the load is shorted. The protection circuit is designed to limit current flow by not latching in the event of a large and instantaneous current flow originating from a large capacitor or other component. These protection circuits are effective in preventing damage due to sudden and unexpected accidents. However, the IC should not be used in applications characterized by the continuous operation or transitioning of the protection circuits. At the time of thermal designing, keep in mind that the current capability has negative characteristics to temperatures. (See Fig. 3)

●Ordering Part Number

B	D		3	5	7	4		H	F	P	-	T	R
□—△形名		Part number					Package			Packaging and forming specification			
		3570 : 3.3V output no include SW					FP : TO252-3, TO252-5			E2: Embossed tape and reel (TO252-3,TO252-5)			
		3571 : 5.0V output no include SW					HFP : HRP5			TR: Embossed tape and reel (HRP5)			
		3572 : variable output no include SW											
		3573 : 3.3V output include SW											
		3574 : 5.0V output include SW											
		3575 : variable output include SW											

TO252-3

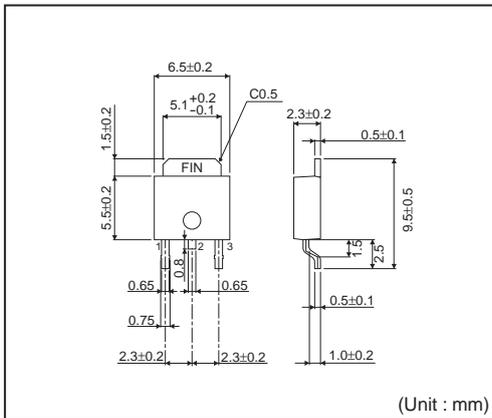

<Tape and Reel information>

Tape	Embossed carrier tape
Quantity	2000pcs
Direction of feed	E2 (The direction is the 1pin of product is at the lower left when you hold reel on the left hand and you pull out the tape on the right hand)

*Order quantity needs to be multiple of the minimum quantity.

TO252-5

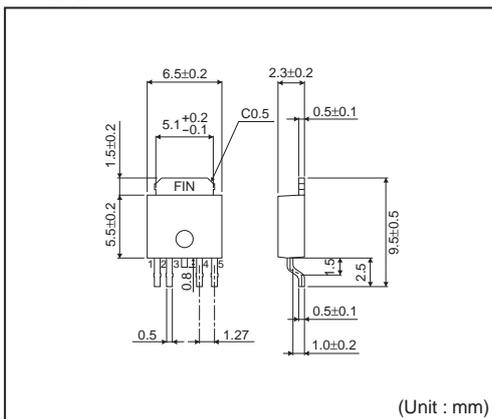

<Tape and Reel information>

Tape	Embossed carrier tape
Quantity	2000pcs
Direction of feed	E2 (The direction is the 1pin of product is at the lower left when you hold reel on the left hand and you pull out the tape on the right hand)

*Order quantity needs to be multiple of the minimum quantity.

HRP5

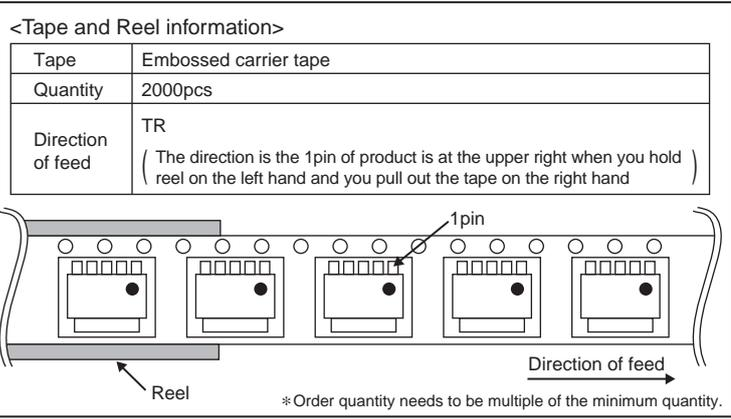
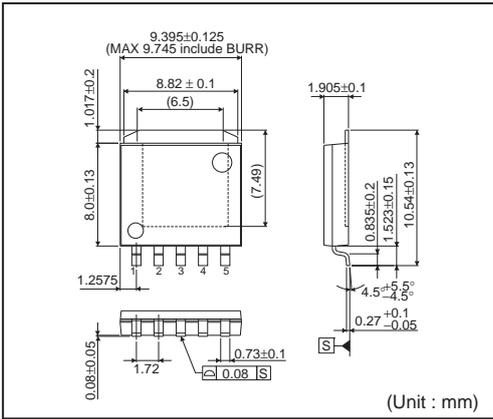

Notice

Precaution on using ROHM Products

- Our Products are designed and manufactured for application in ordinary electronic equipments (such as AV equipment, OA equipment, telecommunication equipment, home electronic appliances, amusement equipment, etc.). If you intend to use our Products in devices requiring extremely high reliability (such as medical equipment ^(Note 1), transport equipment, traffic equipment, aircraft/spacecraft, nuclear power controllers, fuel controllers, car equipment including car accessories, safety devices, etc.) and whose malfunction or failure may cause loss of human life, bodily injury or serious damage to property ("Specific Applications"), please consult with the ROHM sales representative in advance. Unless otherwise agreed in writing by ROHM in advance, ROHM shall not be in any way responsible or liable for any damages, expenses or losses incurred by you or third parties arising from the use of any ROHM's Products for Specific Applications.

(Note1) Medical Equipment Classification of the Specific Applications

JAPAN	USA	EU	CHINA
CLASS III	CLASS III	CLASS II b	CLASS III
CLASS IV		CLASS III	

- ROHM designs and manufactures its Products subject to strict quality control system. However, semiconductor products can fail or malfunction at a certain rate. Please be sure to implement, at your own responsibilities, adequate safety measures including but not limited to fail-safe design against the physical injury, damage to any property, which a failure or malfunction of our Products may cause. The following are examples of safety measures:
 - Installation of protection circuits or other protective devices to improve system safety
 - Installation of redundant circuits to reduce the impact of single or multiple circuit failure
- Our Products are designed and manufactured for use under standard conditions and not under any special or extraordinary environments or conditions, as exemplified below. Accordingly, ROHM shall not be in any way responsible or liable for any damages, expenses or losses arising from the use of any ROHM's Products under any special or extraordinary environments or conditions. If you intend to use our Products under any special or extraordinary environments or conditions (as exemplified below), your independent verification and confirmation of product performance, reliability, etc. prior to use, must be necessary:
 - Use of our Products in any types of liquid, including water, oils, chemicals, and organic solvents
 - Use of our Products outdoors or in places where the Products are exposed to direct sunlight or dust
 - Use of our Products in places where the Products are exposed to sea wind or corrosive gases, including Cl₂, H₂S, NH₃, SO₂, and NO₂
 - Use of our Products in places where the Products are exposed to static electricity or electromagnetic waves
 - Use of our Products in proximity to heat-producing components, plastic cords, or other flammable items
 - Sealing or coating our Products with resin or other coating materials
 - Use of our Products without cleaning residue of flux (even if you use no-clean type fluxes, cleaning residue of flux is recommended); or Washing our Products by using water or water-soluble cleaning agents for cleaning residue after soldering
 - Use of the Products in places subject to dew condensation
- The Products are not subject to radiation-proof design.
- Please verify and confirm characteristics of the final or mounted products in using the Products.
- In particular, if a transient load (a large amount of load applied in a short period of time, such as pulse. is applied, confirmation of performance characteristics after on-board mounting is strongly recommended. Avoid applying power exceeding normal rated power; exceeding the power rating under steady-state loading condition may negatively affect product performance and reliability.
- De-rate Power Dissipation (Pd) depending on Ambient temperature (Ta). When used in sealed area, confirm the actual ambient temperature.
- Confirm that operation temperature is within the specified range described in the product specification.
- ROHM shall not be in any way responsible or liable for failure induced under deviant condition from what is defined in this document.

Precaution for Mounting / Circuit board design

- When a highly active halogenous (chlorine, bromine, etc.) flux is used, the residue of flux may negatively affect product performance and reliability.
- In principle, the reflow soldering method must be used; if flow soldering method is preferred, please consult with the ROHM representative in advance.

For details, please refer to ROHM Mounting specification

Precautions Regarding Application Examples and External Circuits

1. If change is made to the constant of an external circuit, please allow a sufficient margin considering variations of the characteristics of the Products and external components, including transient characteristics, as well as static characteristics.
2. You agree that application notes, reference designs, and associated data and information contained in this document are presented only as guidance for Products use. Therefore, in case you use such information, you are solely responsible for it and you must exercise your own independent verification and judgment in the use of such information contained in this document. ROHM shall not be in any way responsible or liable for any damages, expenses or losses incurred by you or third parties arising from the use of such information.

Precaution for Electrostatic

This Product is electrostatic sensitive product, which may be damaged due to electrostatic discharge. Please take proper caution in your manufacturing process and storage so that voltage exceeding the Products maximum rating will not be applied to Products. Please take special care under dry condition (e.g. Grounding of human body / equipment / solder iron, isolation from charged objects, setting of ionizer, friction prevention and temperature / humidity control).

Precaution for Storage / Transportation

1. Product performance and soldered connections may deteriorate if the Products are stored in the places where:
 - [a] the Products are exposed to sea winds or corrosive gases, including Cl₂, H₂S, NH₃, SO₂, and NO₂
 - [b] the temperature or humidity exceeds those recommended by ROHM
 - [c] the Products are exposed to direct sunshine or condensation
 - [d] the Products are exposed to high Electrostatic
2. Even under ROHM recommended storage condition, solderability of products out of recommended storage time period may be degraded. It is strongly recommended to confirm solderability before using Products of which storage time is exceeding the recommended storage time period.
3. Store / transport cartons in the correct direction, which is indicated on a carton with a symbol. Otherwise bent leads may occur due to excessive stress applied when dropping of a carton.
4. Use Products within the specified time after opening a humidity barrier bag. Baking is required before using Products of which storage time is exceeding the recommended storage time period.

Precaution for Product Label

QR code printed on ROHM Products label is for ROHM's internal use only.

Precaution for Disposition

When disposing Products please dispose them properly using an authorized industry waste company.

Precaution for Foreign Exchange and Foreign Trade act

Since our Products might fall under controlled goods prescribed by the applicable foreign exchange and foreign trade act, please consult with ROHM representative in case of export.

Precaution Regarding Intellectual Property Rights

1. All information and data including but not limited to application example contained in this document is for reference only. ROHM does not warrant that foregoing information or data will not infringe any intellectual property rights or any other rights of any third party regarding such information or data. ROHM shall not be in any way responsible or liable for infringement of any intellectual property rights or other damages arising from use of such information or data.:
2. No license, expressly or implied, is granted hereby under any intellectual property rights or other rights of ROHM or any third parties with respect to the information contained in this document.

Other Precaution

1. This document may not be reprinted or reproduced, in whole or in part, without prior written consent of ROHM.
2. The Products may not be disassembled, converted, modified, reproduced or otherwise changed without prior written consent of ROHM.
3. In no event shall you use in any way whatsoever the Products and the related technical information contained in the Products or this document for any military purposes, including but not limited to, the development of mass-destruction weapons.
4. The proper names of companies or products described in this document are trademarks or registered trademarks of ROHM, its affiliated companies or third parties.

General Precaution

1. Before you use our Products, you are requested to carefully read this document and fully understand its contents. ROHM shall not be in any way responsible or liable for failure, malfunction or accident arising from the use of any ROHM's Products against warning, caution or note contained in this document.
2. All information contained in this document is current as of the issuing date and subject to change without any prior notice. Before purchasing or using ROHM's Products, please confirm the latest information with a ROHM sales representative.
3. The information contained in this document is provided on an "as is" basis and ROHM does not warrant that all information contained in this document is accurate and/or error-free. ROHM shall not be in any way responsible or liable for any damages, expenses or losses incurred by you or third parties resulting from inaccuracy or errors of or concerning such information.

Mouser Electronics

Authorized Distributor

Click to View Pricing, Inventory, Delivery & Lifecycle Information:

[ROHM Semiconductor:](#)

[BD3570HFP-TR](#) [BD3575FP-E2](#) [BD3573HFP-TR](#) [BD3573FP-E2](#)

Компания «Океан Электроники» предлагает заключение долгосрочных отношений при поставках импортных электронных компонентов на взаимовыгодных условиях!

Наши преимущества:

- Поставка оригинальных импортных электронных компонентов напрямую с производств Америки, Европы и Азии, а так же с крупнейших складов мира;
- Широкая линейка поставок активных и пассивных импортных электронных компонентов (более 30 млн. наименований);
- Поставка сложных, дефицитных, либо снятых с производства позиций;
- Оперативные сроки поставки под заказ (от 5 рабочих дней);
- Экспресс доставка в любую точку России;
- Помощь Конструкторского Отдела и консультации квалифицированных инженеров;
- Техническая поддержка проекта, помощь в подборе аналогов, поставка прототипов;
- Поставка электронных компонентов под контролем ВП;
- Система менеджмента качества сертифицирована по Международному стандарту ISO 9001;
- При необходимости вся продукция военного и аэрокосмического назначения проходит испытания и сертификацию в лаборатории (по согласованию с заказчиком);
- Поставка специализированных компонентов военного и аэрокосмического уровня качества (Xilinx, Altera, Analog Devices, Intersil, Interpoint, Microsemi, Actel, Aeroflex, Peregrine, VPT, Syfer, Eurofarad, Texas Instruments, MS Kennedy, Miteq, Cobham, E2V, MA-COM, Hittite, Mini-Circuits, General Dynamics и др.);

Компания «Океан Электроники» является официальным дистрибьютором и эксклюзивным представителем в России одного из крупнейших производителей разъемов военного и аэрокосмического назначения «JONHON», а так же официальным дистрибьютором и эксклюзивным представителем в России производителя высокотехнологичных и надежных решений для передачи СВЧ сигналов «FORSTAR».



JONHON

«JONHON» (основан в 1970 г.)

Разъемы специального, военного и аэрокосмического назначения:

(Применяются в военной, авиационной, аэрокосмической, морской, железнодорожной, горно- и нефтедобывающей отраслях промышленности)

«FORSTAR» (основан в 1998 г.)

ВЧ соединители, коаксиальные кабели, кабельные сборки и микроволновые компоненты:

(Применяются в телекоммуникациях гражданского и специального назначения, в средствах связи, РЛС, а так же военной, авиационной и аэрокосмической отраслях промышленности).



Телефон: 8 (812) 309-75-97 (многоканальный)

Факс: 8 (812) 320-03-32

Электронная почта: ocean@oceanchips.ru

Web: <http://oceanchips.ru/>

Адрес: 198099, г. Санкт-Петербург, ул. Калинина, д. 2, корп. 4, лит. А