

### General Description

The MIC2212 is a dual  $\mu$ Cap low dropout regulator with power-on reset circuit. The first regulator is capable of sourcing 150mA, while the second regulator can source up to 300mA and includes a power-on reset function.

Ideal for battery operated applications, the MIC2212 offers 1% accuracy, extremely low dropout voltage (80mV @ 100mA), and extremely low ground current, only 48 $\mu$ A total. Equipped with TTL-logic-compatible enable pins, the MIC2212 can be put into a zero-off-mode current state, drawing no current when disabled.

The MIC2212 is a  $\mu$ Cap design, operating with very small ceramic output capacitors for stability, reducing required board space and component cost.

The MIC2212 is available in fixed output voltages in the 10-pin 3mm  $\times$  3mm MLF™ leadless package.

### Features

- Input voltage range: 2.25V to 5.5V
- Stable with ceramic output capacitor
- 2 LDO outputs
  - Output 1 – 150mA output current
  - Output 2 – 300mA output current
- Power-on reset function with adjustable delay time
- Low dropout voltage of 80mV @ 100mA
- **Ultra-low quiescent current of 48 $\mu$ A**
- High output accuracy:
  - +1.0% initial accuracy
  - +2.0% over temperature
- Thermal shutdown protection
- Current limit protection
- **Tiny 10-pin 3mm  $\times$  3mm MLF™ package**

### Applications

- Cellular/PCS phones
- Wireless modems
- PDAs

### Typical Application

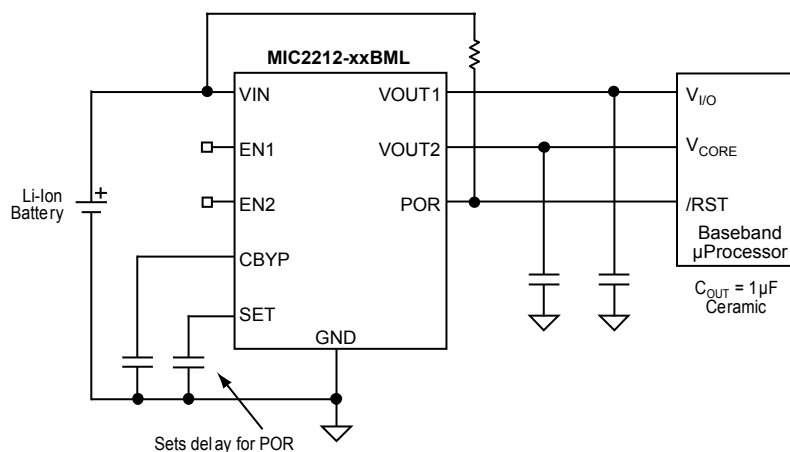

**MIC2212 Typical Cell Phone Application**

## Ordering Information

Part Number			Voltage* (Vo1/Vo2)	Junction Temp. Range	Package
Full	Manufacturing	Pb-Free			
MIC2212-1.6/2.8BML	MIC2212-WMBML	MIC2212-WMYML	1.6V/2.8V	-40°C to +125°C	10-Pin 3x3 MLF™
MIC2212-1.6/3.3BML	MIC2212-WSBML	MIC2212-WSYML	1.6V/3.3V	-40°C to +125°C	10-Pin 3x3 MLF™
MIC2212-1.8/2.6BML	MIC2212-GKBML	MIC2212-GKYML	1.8V/2.6V	-40°C to +125°C	10-Pin 3x3 MLF™
MIC2212-1.8/2.7BML	MIC2212-GLBML	MIC2212-GLYML	1.8V/2.7V	-40°C to +125°C	10-Pin 3x3 MLF™
MIC2212-1.8/2.8BML	MIC2212-GMBML	MIC2212-GMYML	1.8V/2.8V	-40°C to +125°C	10-Pin 3x3 MLF™
MIC2212-1.8/3.3BML	MIC2212-GSBML	MIC2212-GSYML	1.8V/3.3V	-40°C to +125°C	10-Pin 3x3 MLF™
MIC2212-1.85/2.85BML	MIC2212-DNBML	MIC2212-DNYML	1.85V/2.85V	-40°C to +125°C	10-Pin 3x3 MLF™
MIC2212-1.85/2.9BML	MIC2212-DOBML	MIC2212-DOYML	1.85V/2.9V	-40°C to +125°C	10-Pin 3x3 MLF™
MIC2212-2.5/3.3BML	MIC2212-JSBML	MIC2212-JSYML	2.5V/3.3V	-40°C to +125°C	10-Pin 3x3 MLF™
MIC2212-2.6/2.8BML	MIC2212-KMBML	MIC2212-KMYML	2.6V/2.8V	-40°C to +125°C	10-Pin 3x3 MLF™
MIC2212-2.6/2.85BML	MIC2212-KNBML	MIC2212-KNYML	2.6V/2.85V	-40°C to +125°C	10-Pin 3x3 MLF™
MIC2212-2.7/2.8BML	MIC2212-LMBML	MIC2212-LMYML	2.7V/2.8V	-40°C to +125°C	10-Pin 3x3 MLF™
MIC2212-2.7/2.9BML	MIC2212-LOBML	MIC2212-LOYML	2.7V/2.9V	-40°C to +125°C	10-Pin 3x3 MLF™
MIC2212-2.7/3.0BML	MIC2212-LPBML	MIC2212-LPYML	2.7V/3.0V	-40°C to +125°C	10-Pin 3x3 MLF™
MIC2212-2.8/2.6BML	MIC2212-MKBML	MIC2212-MKYML	2.8V/2.6V	-40°C to +125°C	10-Pin 3x3 MLF™
MIC2212-2.8/2.8BML	MIC2212-MMBML	MIC2212-MMYML	2.8V/2.8V	-40°C to +125°C	10-Pin 3x3 MLF™
MIC2212-2.8/3.0BML	MIC2212-MPBML	MIC2212-MPYML	2.8V/3.0V	-40°C to +125°C	10-Pin 3x3 MLF™
MIC2212-2.85/2.85BML	MIC2212-NNBML	MIC2212-NNYML	2.85V/2.85V	-40°C to +125°C	10-Pin 3x3 MLF™
MIC2212-3.0/2.8BML	MIC2212-PMBML	MIC2212-PMYML	3.0V/2.8V	-40°C to +125°C	10-Pin 3x3 MLF™
MIC2212-3.0/2.85BML	MIC2212-PNBML	MIC2212-PNYML	3.0V/2.85V	-40°C to +125°C	10-Pin 3x3 MLF™
MIC2212-3.0/3.0BML	MIC2212-PPBML	MIC2212-PPYML	3.0V/3.0V	-40°C to +125°C	10-Pin 3x3 MLF™
MIC2212-3.0/3.3BML	MIC2212-PSBML	MIC2212-PSYML	3.0V/3.3V	-40°C to +125°C	10-Pin 3x3 MLF™
MIC2212-3.3/1.8BML	MIC2212-SGBML	MIC2212-SGYML	3.3V/1.8V	-40°C to +125°C	10-Pin 3x3 MLF™
MIC2212-3.3/2.5BML	MIC2212-SJBML	MIC2212-SJYML	3.3V/2.5V	-40°C to +125°C	10-Pin 3x3 MLF™
MIC2212-3.3/2.8BML	MIC2212-SMBML	MIC2212-SMYML	3.3V/2.8V	-40°C to +125°C	10-Pin 3x3 MLF™
MIC2212-3.3/3.6BML	MIC2212-SVBML	MIC2212-SVYML	3.3V/3.6V	-40°C to +125°C	10-Pin 3x3 MLF™

\* For other output voltage options, contact Micrel marketing.

Voltage	Code
Adj.	A
1.5	F
1.6	W
1.8	G
1.850	D
1.9	Y
2.0	H
2.1	E
2.5	J
2.6	K
2.7	L

Voltage	Code
2.8	M
2.850	N
2.9	O
3.0	P
3.1	Q
3.2	R
3.3	S
3.4	T
3.5	U
3.6	V

Table 1. Voltage Codes

## Pin Configuration

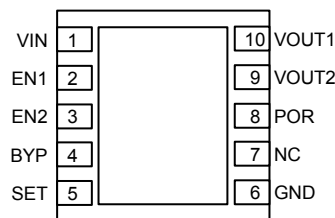

**10-Pin 3mm × 3mm MLF™ (ML)  
(Top View)**

## Pin Description

Pin Number MLF-10 (3x3)	Pin Name	Pin Function
1	VIN	Supply Input: (VIN1 and VIN2 are internally tied together.)
2	EN1	Enable Input to Regulator 1: Enables regulator 1 output. Active high input. High = on, low = off. Do not leave floating.
3	EN2	Enable Input to Regulator 2: Enables regulator 2 output. Active high input. High = on, low = off. Do not leave floating.
4	CBYP	Reference Bypass: Connect external 0.01μF to GND to reduce output noise. May be left open.
5	SET	Delay Set Input: Connect external capacitor to GND to set the internal delay for the POR output. When left open, there is no delay. This pin cannot be grounded.
6	GND	Ground: Connect externally to Exposed Pad.
7	NC	No Connection.
8	POR	Power-On Reset Output: Open-drain output. Active low indicates an output undervoltage condition on regulator 2.
9	VOUT2	Output of Regulator 2: 300mA output current.
10	VOUT1	Output of Regulator 1: 150mA output current.
EP	GND	Ground: Internally connected to the Exposed Pad. Connect externally to pin 6 of the IC.

**Absolute Maximum Rating<sup>(1)</sup>**

Supply Input Voltage ( $V_{IN}$ ).....	0V to 7V
Enable Input Voltage ( $V_{EN}$ ) .....	0V to 7V
Power Dissipation ( $P_D$ ).....	Internally Limited, <b>Note 3</b>
Junction Temperature.....	-40°C to +125°C
Storage Temperature ( $T_S$ ).....	-65°C to 150°C
Lead Temperature (soldering, 5 sec.).....	260°C

**Operating Ratings<sup>(2)</sup>**

Supply Input Voltage ( $V_{IN}$ ).....	2.25V to 5.5V
Enable Input Voltage ( $V_{EN}$ ) .....	0V to $V_{in}$
Junction Temperature ( $T_J$ ).....	-40°C to +125°C
Package Thermal Resistance MLF™-10 ( $\theta_{JA}$ ).....	60°C/W

**Electrical Characteristics<sup>(4)</sup>**

$V_{IN} = V_{OUT} + 1.0V$  for higher output of the regulator pair;  $C_{OUT} = 1.0\mu F$ ,  $I_{OUT} = 100\mu A$ ;  $T_J = 25^\circ C$ , **bold** values indicate  $-40^\circ C \leq T_J \leq +125^\circ C$ ; unless noted.

Parameter	Conditions	Min	Typ	Max	Units
Output Voltage Accuracy	Variation from nominal $V_{OUT}$	-1.0		+1.0	%
		<b>-2.0</b>		<b>+2.0</b>	%
Output Voltage Temp. Coefficient			40		ppm/C
Line Regulation <sup>(5)</sup>	$V_{IN} = V_{OUT} + 1V$ to 5.5V	-0.3 <b>-0.6</b>	0.02	0.3 <b>0.6</b>	%/V
Load Regulation	$I_{OUT} = 100\mu A$ to 150mA (Regulator 1 and 2)		0.2	1.0	%
	$I_{OUT} = 100\mu A$ to 300mA (Regulator 2)			1.5	%
Dropout Voltage <sup>(6)</sup>	$I_{OUT} = 150mA$ (Regulator 1 and 2)		120	190 <b>250</b>	mV mV
	$I_{OUT} = 300mA$ (Regulator 2)		240	340 <b>420</b>	mV
Ground Pin Current	$I_{OUT1} = I_{OUT2} = 0\mu A$		48	65 <b>80</b>	$\mu A$ $\mu A$
	$I_{OUT1} = 150mA$ and $I_{OUT2} = 300mA$		60		$\mu A$
Ground Pin Current in Shutdown	$V_{EN} \leq 0.4V$			<b>2.0</b>	$\mu A$
Ripple Rejection	$f = 1kHz$ ; $C_{OUT} = 1.0\mu F$ ceramic; $C_{BYP} = 10nF$		60		dB
	$f = 20kHz$ ; $C_{OUT} = 1.0\mu F$ ceramic; $C_{BYP} = 10nF$		40		dB
Current Limit	$V_{OUT} = 0V$ (Regulator 1)	150	280	460	mA
	$V_{OUT} = 0V$ (Regulator 2)	300	450	700	mA
Output Voltage Noise	$C_{OUT} = 1\mu F$ , $C_{BYP} = 0.01\mu F$ , 10Hz to 100kHz		30		$\mu V_{rms}$

**Enable Input**

Enable Input Voltage	Logic Low (Regulator Shutdown)			<b>0.6</b>	V
	Logic High (Regulator Enabled)	<b>1.8</b>			V
Enable Input Current	$V_{IL} < 0.6V$ (Regulator Shutdown)	-1	0.01	+1	$\mu A$
	$V_{IH} > 1.8V$ (Regulator Enabled)	-1	0.01	+1	$\mu A$

**POR Output**

$V_{TH}$	Low Threshold, % of nominal $V_{OUT2}$ (Flag ON)	90			%
	High Threshold, % of nominal $V_{OUT2}$ (Flag OFF)			96	%
$V_{OL}$	POR Output Logic Low Voltage; $I_L = 250\mu A$		0.02	0.1	V
$I_{POR}$	Flag Leakage Current, Flag OFF	-1	0.01	+1	$\mu A$

Parameter	Conditions	Min	Typ	Max	Units
<b>SET Input</b>					
SET Pin Current Source	$V_{SET} = 0V$	0.75	1.25	1.75	$\mu A$
SET Pin Threshold Voltage	$P_{OR} = High$		1.25		V

**Notes**

1. Exceeding maximum rating may damage the device.
2. The device is not guaranteed to work outside its operating rating.
3. The maximum allowable power dissipation of any  $T_A$  (ambient temperature) is  $(P_D(max) = T_J(max) - T_A) / \theta_{JA}$ . Exceeding the maximum allowable power dissipation will result in excessive die temperature, and the regulator will go into thermal shutdown.
4. Specification for packaged product only.
5. Minimum input for line regulation test is set to  $V_{OUT} + 1V$  relative to the highest output voltage.
6. Dropout voltage is defined as the input-to-output differential at which the output voltage drops 2% below its nominal value measured at 1V differential. For outputs below 2.25V, dropout voltage is the input-to-output voltage differential with the minimum input voltage 2.25V. Minimum input operating voltage is 2.25V.

# Typical Characteristics

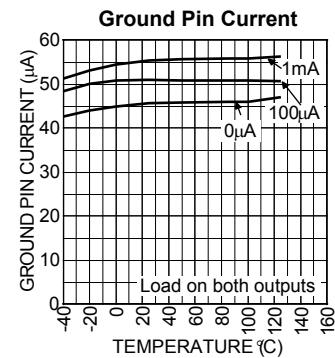
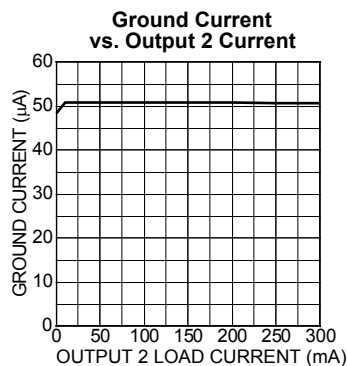
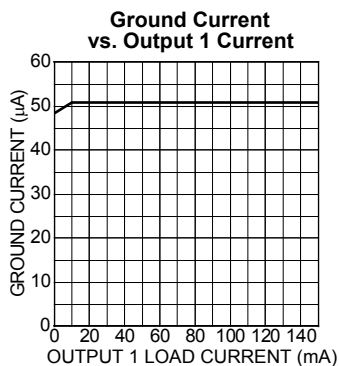
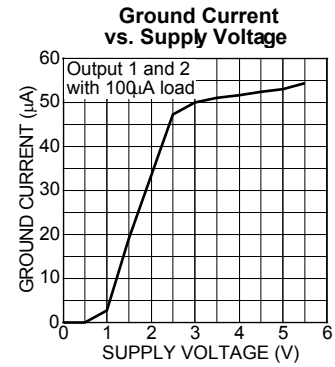
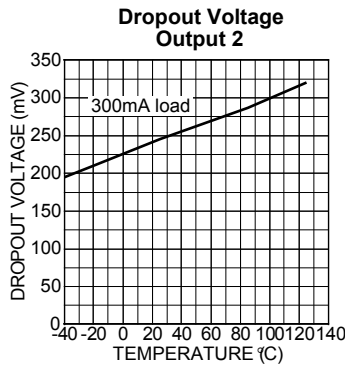
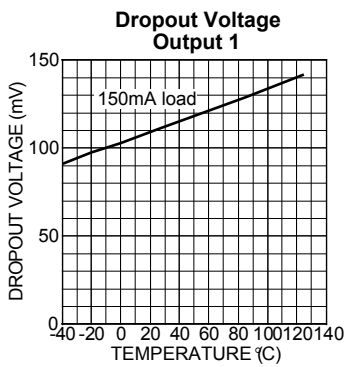
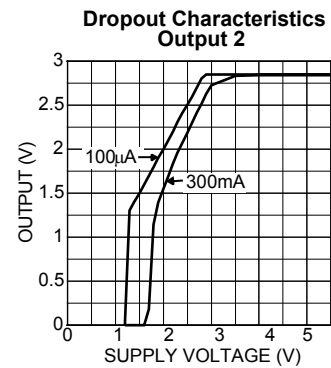
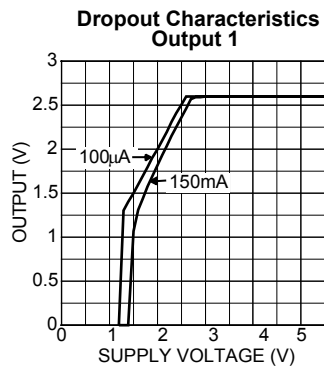
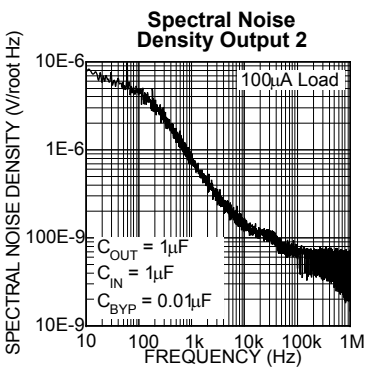
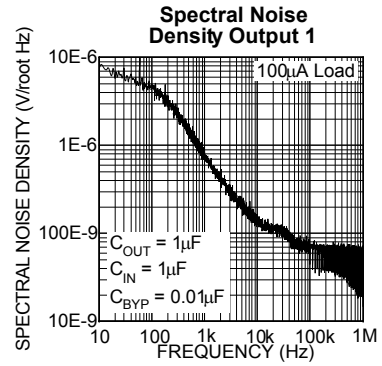
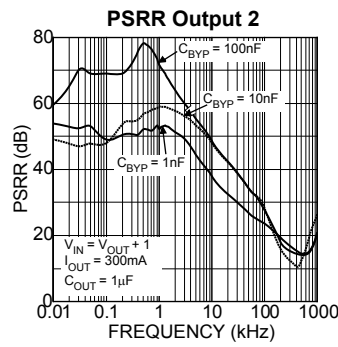
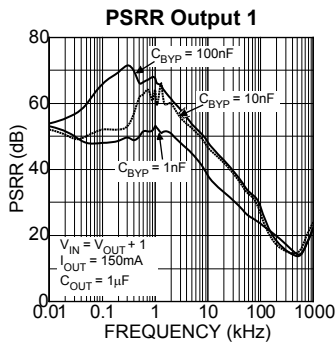

### Typical Characteristics (cont.)

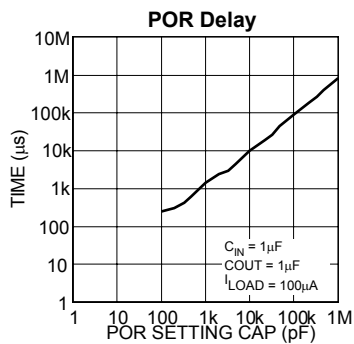
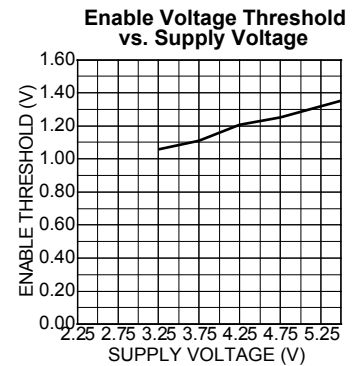
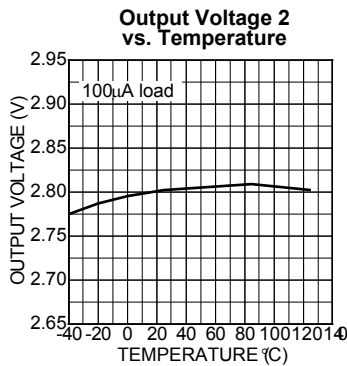
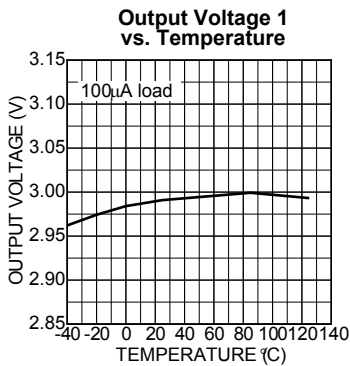
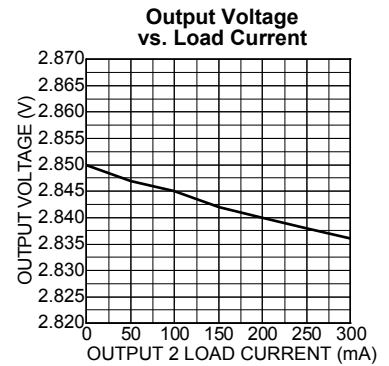
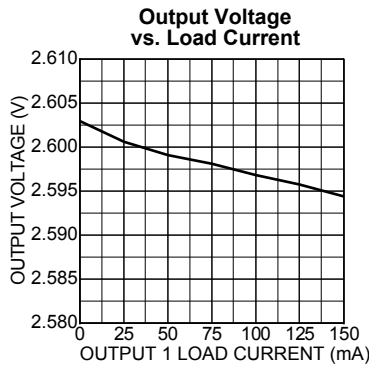
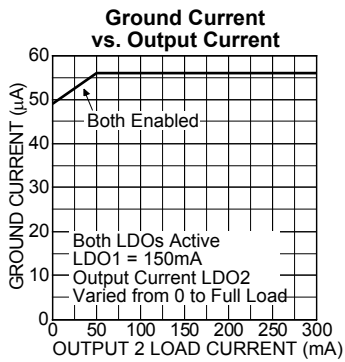
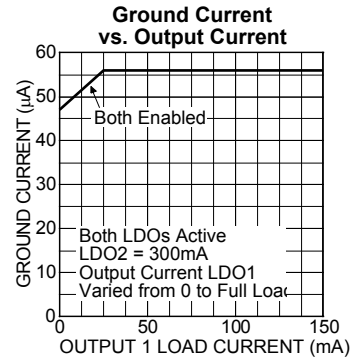
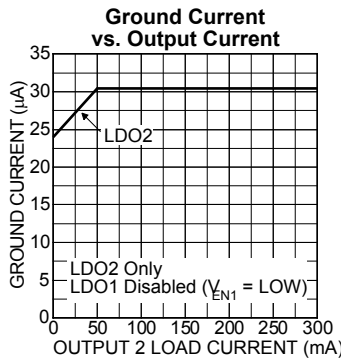
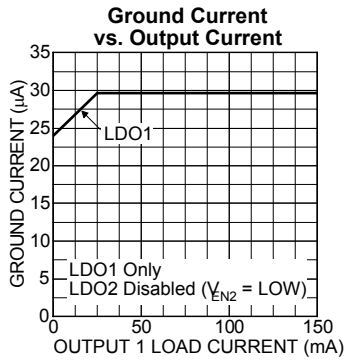

# Functional Characteristics

**Enable Characteristics**

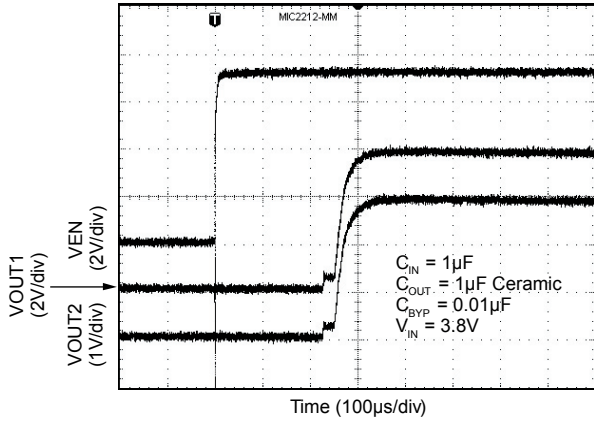

**Power-On Reset Characteristics**

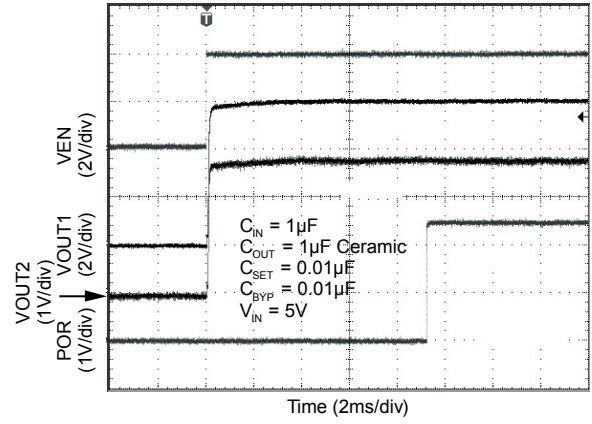

**Load Transient Response (LDO 1)**

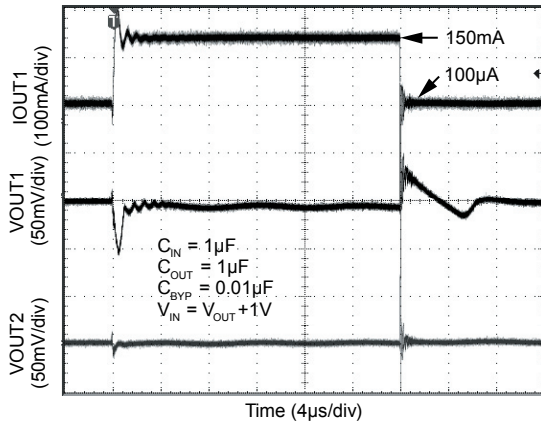

**Load Transient Response (LDO 2)**

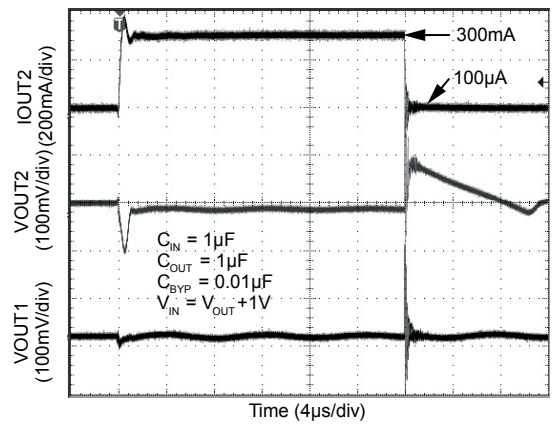



## Functional Diagram

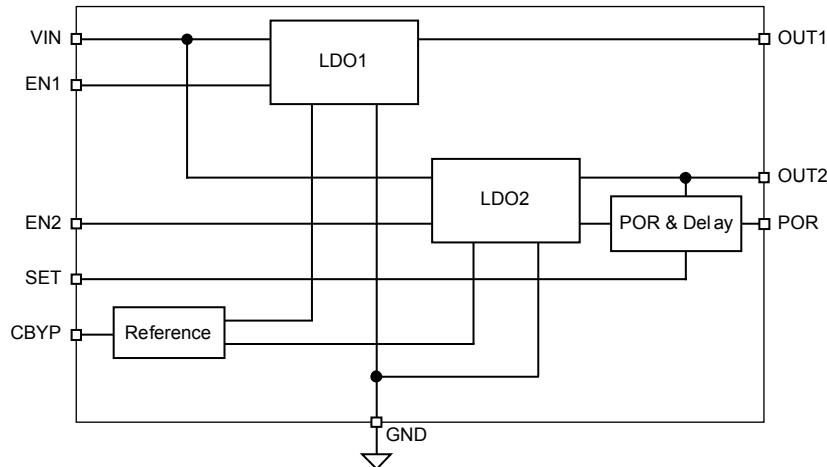

**MIC2212 Fixed Voltage Block Diagram**

## Functional Description

The MIC2212 is a high performance, low quiescent current power management IC consisting of two  $\mu$ Cap low dropout regulators, a power-on reset (POR) circuit and an open-drain driver. The first regulator is capable of sourcing 150mA at output voltages from 1.25V to 5V. The second regulator is capable of sourcing 300mA of current at output voltages from 1.25V to 5V. The second regulator has a POR circuit that monitors its output voltage and indicates when the output voltage is within 5% of nominal. The POR offers a delay time that is externally programmable with a single capacitor to ground.

### Enable 1 and 2

The enable inputs allow for logic control of both output voltages with individual enable inputs. The enable input is active high, requiring 1.8V for guaranteed operation. The enable input is CMOS logic and cannot be left floating.

### Power-On Reset (POR)

The power-on reset output is an open-drain N-Channel device, requiring a pull-up resistor to either the input voltage or output voltage for proper voltage levels. The POR output has a delay time that is programmable with a capacitor from the SET pin to ground. The delay time can be programmed to be as long as 1 second.

The SET pin is a current source output that charges a capacitor that sets the delay time for the power-on reset output. The current source is a 1 $\mu$ A current source that charges a capacitor up from 0V. When the capacitor reaches 1.25V, the output of the POR is allowed to go high.

### Input Capacitor

Good bypassing is recommended from input to ground to help improve AC performance. A 1 $\mu$ F capacitor or greater located close to the IC is recommended.

### Bypass Capacitor

The internal reference voltage of the MIC2212 can be bypassed with a capacitor to ground to reduce output noise and increase power supply rejection (PSRR). A quick-start feature allows for quick turn-on of the output voltage regardless of the size of the capacitor. The recommended nominal bypass capacitor is 0.01 $\mu$ F, but it can be increased without limit.

### Output Capacitor

Each regulator output requires a 1 $\mu$ F ceramic output capacitor for stability. The output capacitor value can be increased to improve transient response, but performance has been optimized for a 1 $\mu$ F ceramic type output capacitor.

X7R/X5R dielectric-type ceramic capacitors are recommended because of their temperature performance. X7R-type capacitors change capacitance by 15% over their operating temperature range and are the most stable type of ceramic capacitors. Z5U and Y5V dielectric capacitors change value by as much as 50% and 60% respectively over their operating temperature ranges. To use a ceramic chip capacitor with Y5V dielectric, the value must be much higher than a X7R ceramic capacitor to ensure the same minimum capacitance over the equivalent operating temperature range.

## Package Information

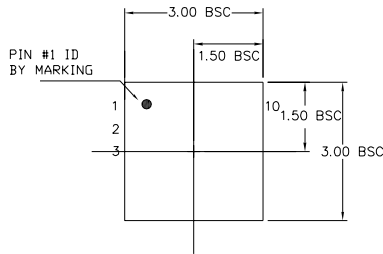

TOP VIEW

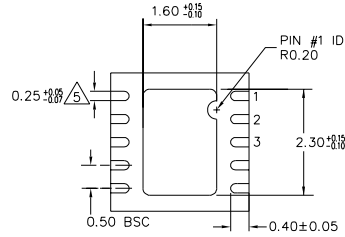

BOTTOM VIEW

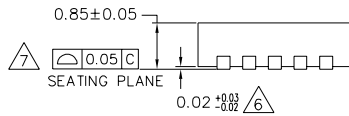

SIDE VIEW

- NOTE:
1. ALL DIMENSIONS ARE IN MILLIMETERS.
  2. MAX. PACKAGE WARPAGE IS 0.05 mm.
  3. MAXIMUM ALLOWABLE BURRS IS 0.076 mm IN ALL DIRECTIONS.
  4. PIN #1 ID ON TOP WILL BE LASER/INK MARKED.
- △ DIMENSION APPLIES TO METALIZED TERMINAL AND IS MEASURED BETWEEN 0.20 AND 0.25 mm FROM TERMINAL TIP.
- △ APPLIED ONLY FOR TERMINALS.
- △ APPLIED FOR EXPOSED PAD AND TERMINALS.

### 10-Pin 3mm x 3mm MLF (ML)

**MICREL INC. 2180 FORTUNE DRIVE SAN JOSE, CA 95131 USA**  
 TEL + 1 (408) 944-0800 FAX + 1 (408) 474-1000 WEB <http://www.micrel.com>

This information furnished by Micrel in this data sheet is believed to be accurate and reliable. However no responsibility is assumed by Micrel for its use. Micrel reserves the right to change circuitry and specifications at any time without notification to the customer.

Micrel Products are not designed or authorized for use as components in life support appliances, devices or systems where malfunction of a product can reasonably be expected to result in personal injury. Life support devices or systems are devices or systems that (a) are intended for surgical implant into the body or (b) support or sustain life, and whose failure to perform can be reasonably expected to result in a significant injury to the user. A Purchaser's use or sale of Micrel Products for use in life support appliances, devices or systems is a Purchaser's own risk and Purchaser agrees to fully indemnify Micrel for any damages resulting from such use or sale.

Компания «Океан Электроники» предлагает заключение долгосрочных отношений при поставках импортных электронных компонентов на взаимовыгодных условиях!

Наши преимущества:

- Поставка оригинальных импортных электронных компонентов напрямую с производств Америки, Европы и Азии, а так же с крупнейших складов мира;
- Широкая линейка поставок активных и пассивных импортных электронных компонентов (более 30 млн. наименований);
- Поставка сложных, дефицитных, либо снятых с производства позиций;
- Оперативные сроки поставки под заказ (от 5 рабочих дней);
- Экспресс доставка в любую точку России;
- Помощь Конструкторского Отдела и консультации квалифицированных инженеров;
- Техническая поддержка проекта, помощь в подборе аналогов, поставка прототипов;
- Поставка электронных компонентов под контролем ВП;
- Система менеджмента качества сертифицирована по Международному стандарту ISO 9001;
- При необходимости вся продукция военного и аэрокосмического назначения проходит испытания и сертификацию в лаборатории (по согласованию с заказчиком);
- Поставка специализированных компонентов военного и аэрокосмического уровня качества (Xilinx, Altera, Analog Devices, Intersil, Interpoint, Microsemi, Actel, Aeroflex, Peregrine, VPT, Syfer, Eurofarad, Texas Instruments, MS Kennedy, Miteq, Cobham, E2V, MA-COM, Hittite, Mini-Circuits, General Dynamics и др.);

Компания «Океан Электроники» является официальным дистрибьютором и эксклюзивным представителем в России одного из крупнейших производителей разъемов военного и аэрокосмического назначения «JONHON», а так же официальным дистрибьютором и эксклюзивным представителем в России производителя высокотехнологичных и надежных решений для передачи СВЧ сигналов «FORSTAR».



## JONHON

«JONHON» (основан в 1970 г.)

Разъемы специального, военного и аэрокосмического назначения:

(Применяются в военной, авиационной, аэрокосмической, морской, железнодорожной, горно- и нефтедобывающей отраслях промышленности)

«FORSTAR» (основан в 1998 г.)

ВЧ соединители, коаксиальные кабели, кабельные сборки и микроволновые компоненты:

(Применяются в телекоммуникациях гражданского и специального назначения, в средствах связи, РЛС, а так же военной, авиационной и аэрокосмической отраслях промышленности).



Телефон: 8 (812) 309-75-97 (многоканальный)

Факс: 8 (812) 320-03-32

Электронная почта: [ocean@oceanchips.ru](mailto:ocean@oceanchips.ru)

Web: <http://oceanchips.ru/>

Адрес: 198099, г. Санкт-Петербург, ул. Калинина, д. 2, корп. 4, лит. А