

Description

The AP3428/A is a 1A step-down DC-DC converter. At heavy load, the constant-frequency PWM control performs excellent stability and transient response. No external compensation components are required.

The AP3428/A supports a range of input voltages from 2.5V to 5.5V, allowing the use of a single Li+/Li-polymer cell, multiple Alkaline/NiMH cell, and other standard power sources. The output voltage is adjustable from 0.6V to the input voltage. The AP3428/A employs internal power switch and synchronous rectifier to minimize external part count and realize high efficiency. During shutdown, the input is disconnected from the output and the shutdown current is less than 1 μ A. Other key features include over-temperature and short circuit protection, and under-voltage lockout to prevent deep battery discharge.

The AP3428/A delivers 1A maximum output current while consuming only 40 μ A of no-load quiescent current. Ultra-low $R_{DS(ON)}$ integrated MOSFETs and 100% duty cycle operation make the AP3428/A an ideal choice for high output voltage, high current applications which require a low dropout threshold. Pulse skip mode allows to maintain high efficiency at light-load conditions.

The AP3428/A is available in TSOT25, U-DFN2020-6 (Type J) packages.

Features

- Output Current: Up to 1A
- Output Voltage: 0.6V to V_{IN}
- Input Voltage: 2.5V to 5.5V
- 0.6V Reference Voltage With $\pm 2\%$ Precision
- 40 μ A (Typ) No Load Quiescent Current
- Shutdown Current: $< 1\mu$ A
- 100% Duty Cycle Operation
- 1.5MHz Switching Frequency
- Internal Soft Start
- No External Compensation Required
- Current Limit Protection
- Thermal Shutdown
- TSOT25, U-DFN2020-6 (Type J) Packages
- **Totally Lead-Free & Fully RoHS Compliant (Notes 1 & 2)**
- **Halogen and Antimony Free. "Green" Device (Note 3)**

- Notes:
1. No purposely added lead. Fully EU Directive 2002/95/EC (RoHS) & 2011/65/EU (RoHS 2) compliant.
 2. See http://www.diodes.com/quality/lead_free.html for more information about Diodes Incorporated's definitions of Halogen- and Antimony-free, "Green" and Lead-free.
 3. Halogen- and Antimony-free "Green" products are defined as those which contain < 900 ppm bromine, < 900 ppm chlorine (< 1500 ppm total Br + Cl) and < 1000 ppm antimony compounds.

Pin Assignments

(Top View)

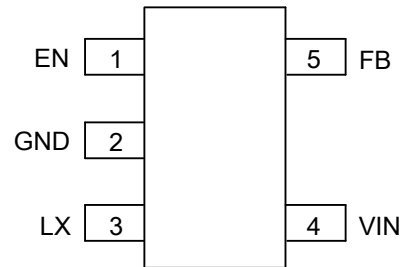

TSOT25 for AP3428

(Top View)

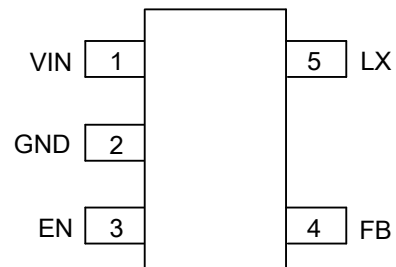

TSOT25 for AP3428A

(Top View)

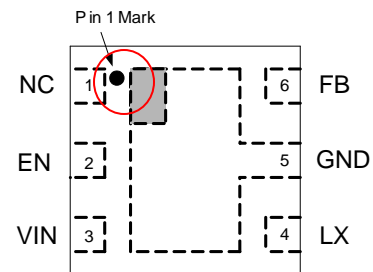

U-DFN2020-6 (Type J)

Applications

- Post DC-DC Voltage Regulation
- Set Top Boxes
- Notebook Computer
- PAD

Typical Applications Circuit

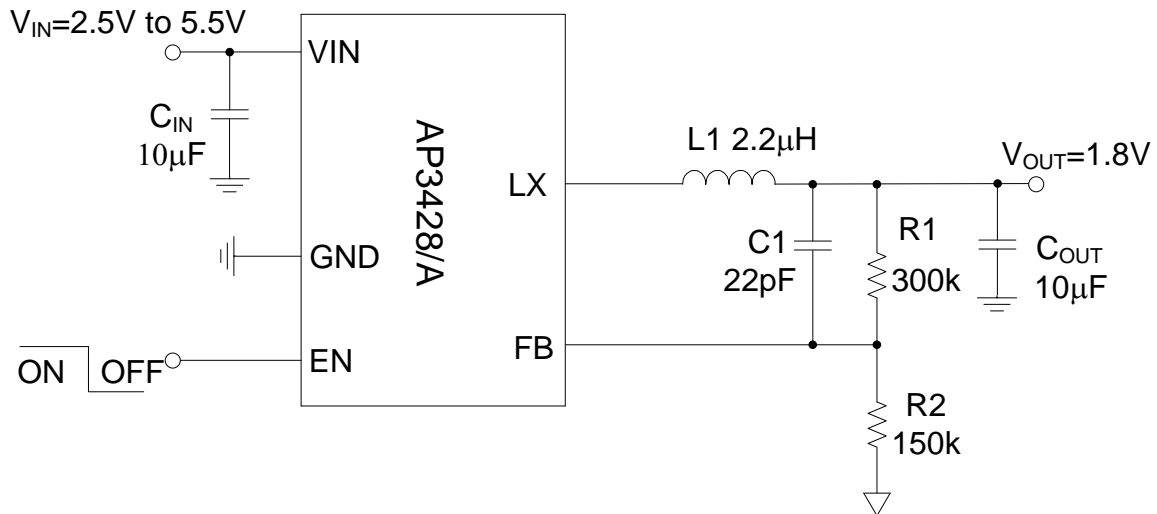

Pin Descriptions

Pin Number			Pin Name	Function
TSOT25 for AP3428	TSOT25 for AP3428A	U-DFN2020-6 (Type J)		
1	3	2	EN	Enable control input. Force this pin voltage above 1.5V enables the chip, and below 0.4V shuts down the device.
2	2	5	GND	Ground pin
3	5	4	LX	The drains of the internal main and synchronous power MOSFET.
4	1	3	VIN	Bias supply. Chip main power supply pin
5	4	6	FB	Feedback voltage to internal error amplifier, the threshold voltage is 0.6V.
-	-	1	NC	NC

Absolute Maximum Ratings (Note 4)

Symbol	Parameter	Rating		Unit
V_{IN}	Input Voltage	-0.3 to 6		V
V_{EN}	EN Pin Voltage	-0.3 to $V_{IN}+0.3$		V
V_{LX}	LX Pin Voltage	-0.3 to $V_{IN}+0.3$		V
V_{FB}	Feedback Pin Voltage	-0.3 to $V_{IN}+0.3$		V
P_D	Power Dissipation (on PCB, $T_A = +25^\circ\text{C}$)	TSOT25	0.4	W
		U-DFN2020-6 (Type J)	1.89	
θ_{JA}	Thermal Resistance (Junction to Ambient)	TSOT25	220	$^\circ\text{C/W}$
		U-DFN2020-6 (Type J)	53	
θ_{JC}	Thermal Resistance (Junction to Case, Simulation)	TSOT25	130	$^\circ\text{C/W}$
		U-DFN2020-6 (Type J)	25	
T_J	Operating Junction Temperature	+155		$^\circ\text{C}$
T_{STG}	Storage Temperature	-55 to +150		$^\circ\text{C}$
V_{MM}	ESD (Machine Model)	200		V
V_{HBM}	ESD (Human Body Model)	2000		V
V_{CDM}	ESD (Charge Device Mode)	1000		V

Note 4: Stresses greater than those listed under "Absolute Maximum Ratings" may cause permanent damage to the device. These are stress ratings only, and functional operation of the device at these or any other conditions beyond those indicated under "Recommended Operating Conditions" is not implied. Exposure to "Absolute Maximum Ratings" for extended periods may affect device reliability.

Recommended Operating Conditions

Symbol	Parameter	Min	Max	Unit
V_{IN}	Supply Voltage	2.5	5.5	V
T_J	Junction Temperature Range	-40	+125	$^\circ\text{C}$
T_A	Operating Ambient Temperature	-40	+85	$^\circ\text{C}$

Electrical Characteristics (@T_A = +25°C, V_{IN} = 5.0V, V_{OUT} = 2.5V, C_{OUT} = 10μF, L = 2.2μH, unless otherwise specified.)

Symbol	Parameter	Condition	Min	Typ	Max	Unit
V _{IN}	Input Voltage Range	–	2.5	–	5.5	V
V _{OUT}	Output Voltage Range	–	0.6	–	V _{IN}	V
I _Q	Quiescent Current	V _{FB} = 0.65V	–	40	–	μA
I _{SD}	Shutdown Current	V _{EN} = 0V	–	0.1	1	μA
V _{FB}	Regulated Feedback Voltage	–	0.588	0.6	0.612	V
I _{FB}	FB Leakage Current	V _{FB} = 1V	–	–	0.2	μA
I _{LIM}	Peak Inductor Current	–	1.3	–	–	A
f _{OSC}	Oscillator Frequency	–	–	1.5	–	MHz
R _{DS(ON)}	Drain-Source On-State Resistance	I _{SW} = 100mA High Side	–	250	–	mΩ
		I _{SW} = 100mA Low Side	–	170	–	mΩ
R _{DISCH}	Output Discharge Switch On Resistor	–	–	2.1	–	KΩ
V _{ENH}	EN Threshold High	–	1.5	–	–	V
V _{ENL}	EN Threshold Low	–	–	–	0.4	V
I _{EN}	EN Leakage Current	V _{IN} = V _{EN} = 5V	-1.0	–	1.0	μA
V _{UVLO}	Input UVLO Threshold	–	–	2.4	2.7	V
V _{HYS}	UVLO Hysteresis	–	–	0.1	–	V
T _{OTP}	Over Temperature Protection	–	–	+160	–	°C
T _{OTH}	OTP Hysteresis	–	–	+15	–	°C
t _{SS}	Soft-start Time	–	–	2	–	ms

Performance Characteristics (@ $T_A = +25^\circ\text{C}$, $V_{IN} = 5\text{V}$, $V_{OUT} = 1.8\text{V}$, unless otherwise specified.)

Efficiency vs. Load Current

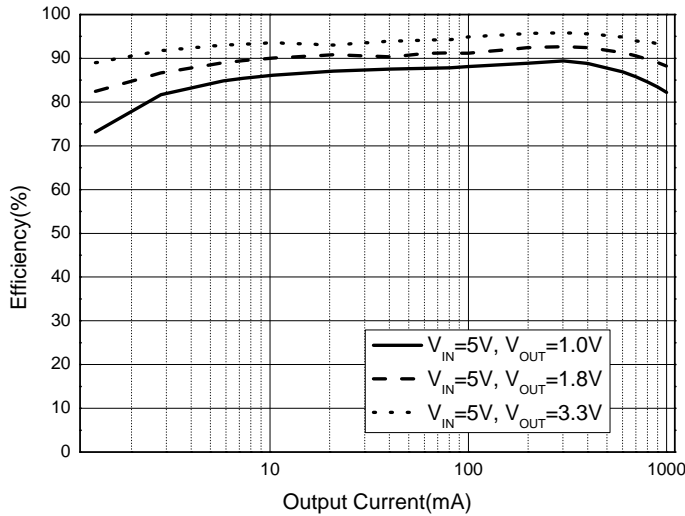

Feedback Reference Voltage vs. Temperature

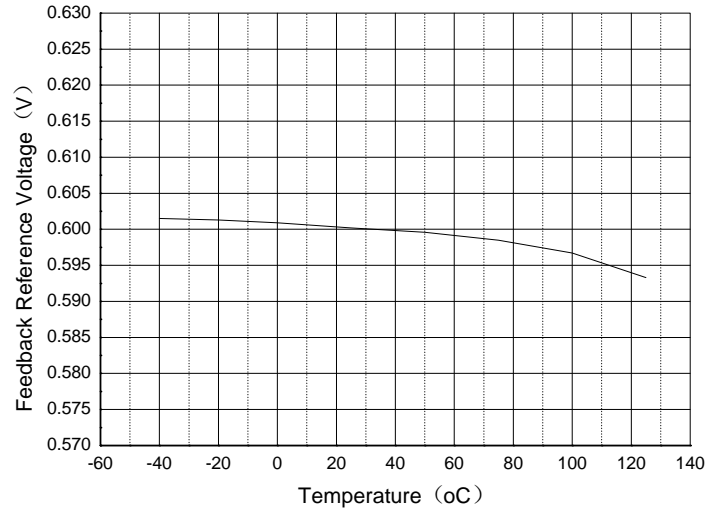

PFET Drain-Source On-State Resistance vs. Temperature

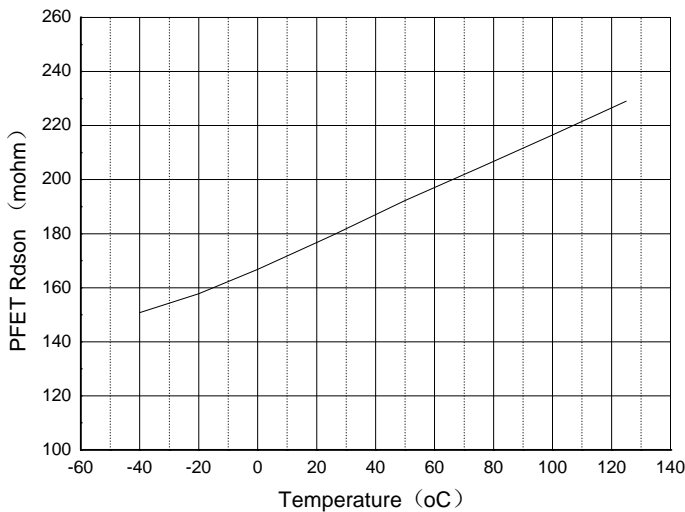

NFET Drain-Source On-State Resistance vs. Temperature

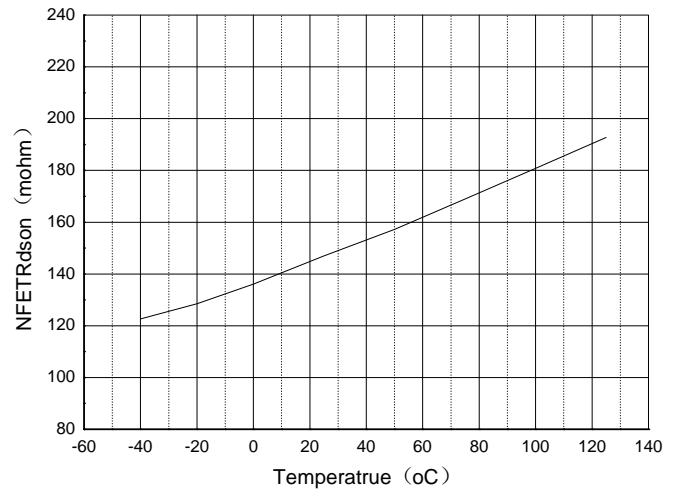

Quiescent Current vs. Temperature

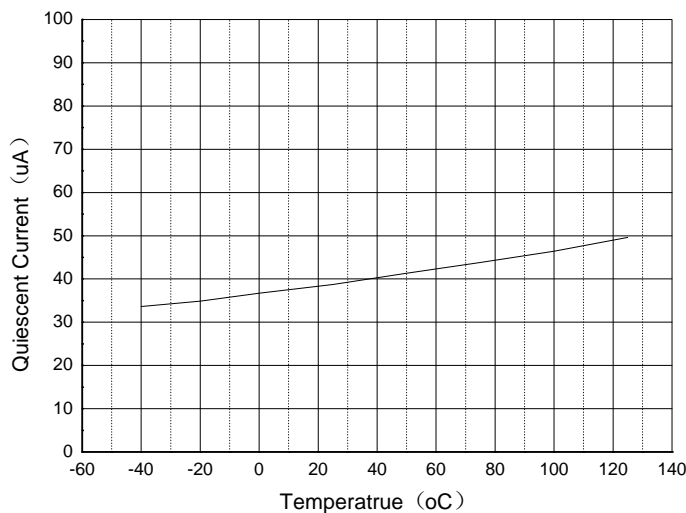

Oscillation Frequency vs. Temperature

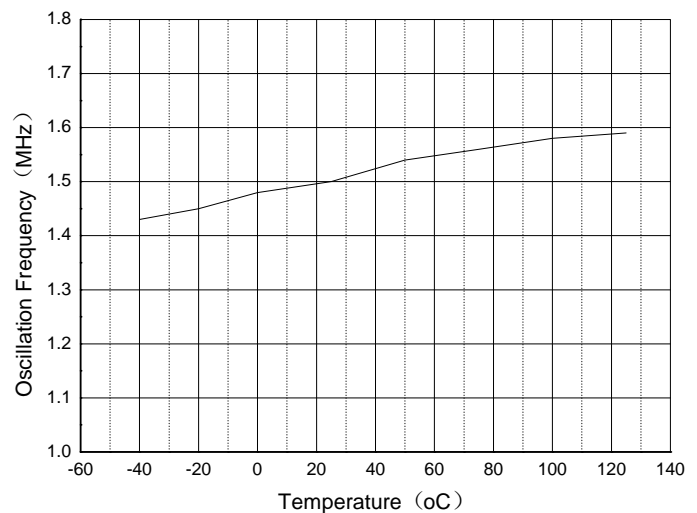

Performance Characteristics (@ $T_A = +25^\circ\text{C}$, $V_{IN} = 5\text{V}$, $V_{OUT} = 1.8\text{V}$, unless otherwise specified.)

Enable Turn on Characteristic ($I_{OUT}=1\text{A}$)

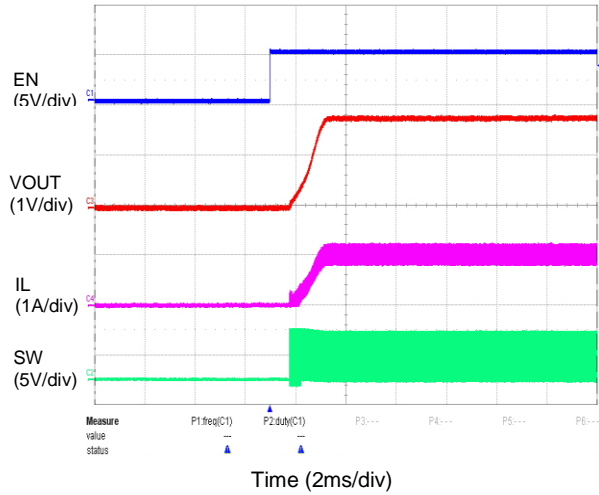

Enable Turn off Characteristic ($I_{OUT}=1\text{A}$)

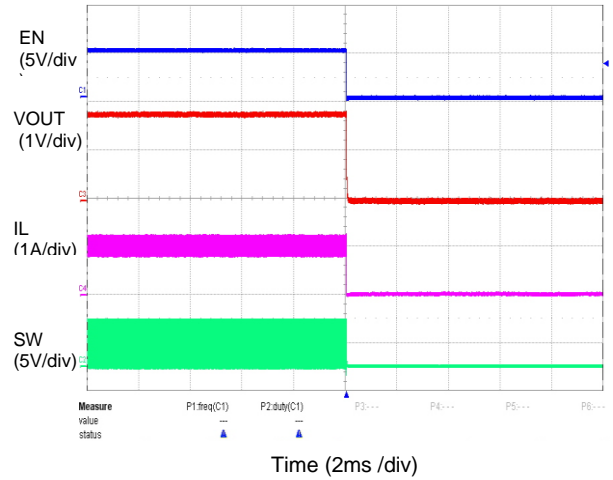

Short Current Protection ($I_{OUT}=1\text{A}$)

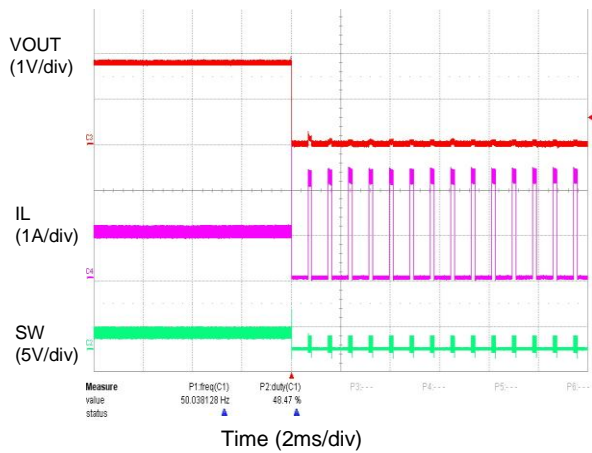

SCP Recovery ($I_{OUT}=1\text{A}$)

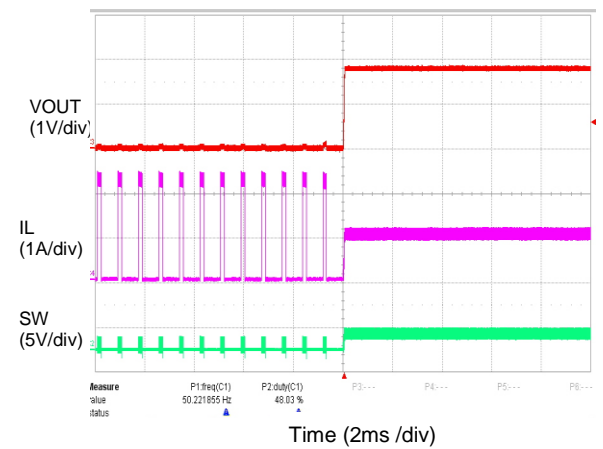

Load Transient ($I_{OUT}=0.1\text{A}$ to 1A)

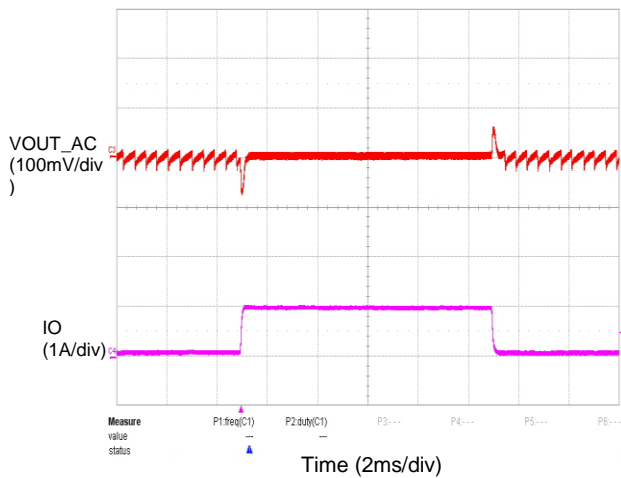

Load Transient ($I_{OUT}=0.5\text{A}$ to 1A)

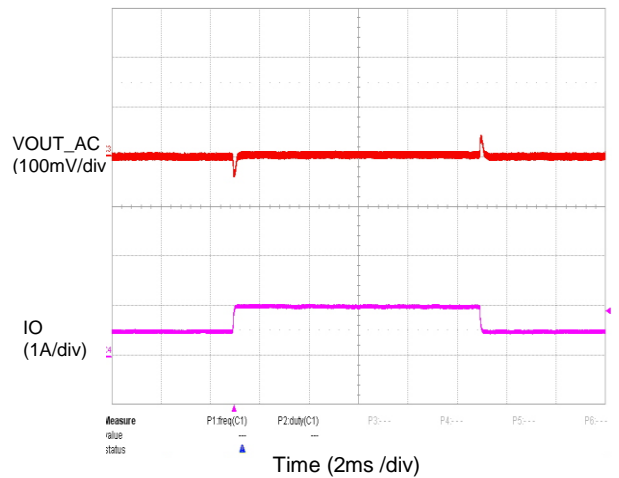

Application Information

Typical application circuit is shown in the Typical Applications Circuit and for the circuit parameters setting please refers to the following descriptions.

Under Voltage Lockout (UVLO) Circuit

When the V_{IN} drops lower than the UVLO detector threshold, the UVLO circuit starts to operate, V_{REF} stops, and high-side switch and low-side switch built-in switch transistors turn "OFF". As a result, V_{OUT} drops according to the C_{OUT} capacitance value and the load. When the V_{IN} is rising higher than UVLO released voltage, the IC will restart the operation.

Short Circuit Protection and Recovery

When the AP3428/A output node is shorted to GND that V_{FB} drops under 0.42V, AP3428/A will enter hiccup mode to protect itself. If short circuit is removed, and V_{FB} rises over 0.42V, the AP3428/A recovers to normal operation again. If the AP3428/A reaches OCP threshold while short circuit, the AP3428/A will enter cycle by cycle current limit mode until the current under OCP threshold.

Over Temperature Protection

The internal thermal temperature protection circuitry is provided to protect the integrated circuit in the event that the maximum junction temperature is exceeded. When the junction temperature exceeds +160°C, it shuts down the internal control circuit and switching power MOSFET. The AP3428/A will restart automatically under the control of soft start circuit when the junction temperature decreases to +145°C.

Setting the Output Voltage

The output voltage can be adjusted from 1 to 5V using an external resistor divider. Table 1 shows a list of resistor selections for common output voltages. Resistor R1 is selected based on a design tradeoff between efficiency and output voltage accuracy. For high values of R1 there is less current consumption in the feedback network. However the tradeoff is output voltage accuracy due to the bias current in the error amplifier. R1 can be determined by the following equation. Meanwhile, the input capacitor should close to IC for preventing unexpected influences.

$$R1 = R2 \cdot \left(\frac{V_{out}}{0.6} - 1 \right)$$

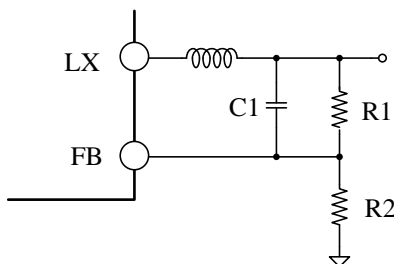
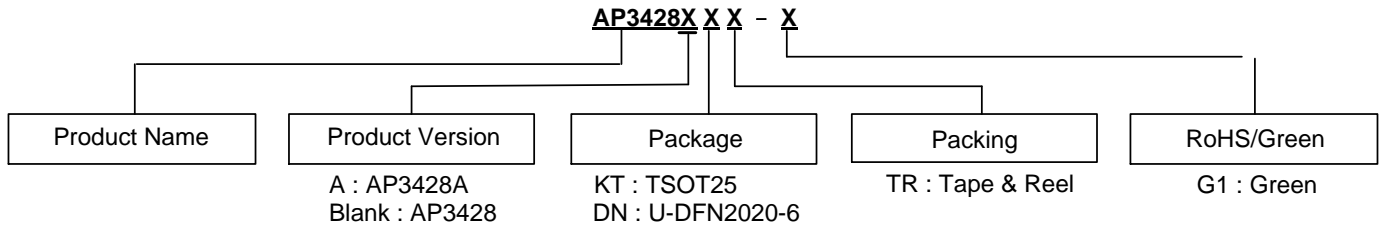

Figure 1. Feedback Divider Network

Out Voltage	R1	R2	C1
1.0V	91k	120k	22pf
1.2V	100k	100k	22pf
1.5V	150k	100k	22pf
1.8V	300k	150k	22pf
2.5V	380k	120k	22pf
2.8V	440k	120k	22pf
3.3V	430k	100k	22pf

Table 1. Resistor Selection for Common Output

Ordering Information



Package	Temperature Range	Part Number	Marking ID	Packing
TSOT25	-40 to +85°C	AP3428AKTTR-G1	L2J	3000/Tape & Reel
		AP3428KTTR-G1	L2H	3000/Tape & Reel
U-DFN2020-6 (Type J)		AP3428DNTR-G1	CQ	3000/Tape & Reel

Marking Information

(1) TSOT25 for AP3428

(Top View)

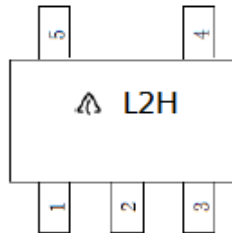

First Line: Logo and Marking ID

(2) TSOT25 for AP3428A

(Top View)

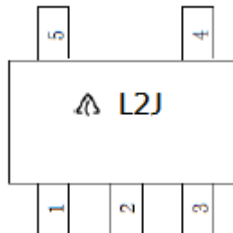

First Line: Logo and Marking ID

(3) U-DFN2020-6 (Type J)

(Top View)

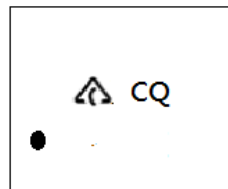

First Line: Logo and Marking ID

Package Outline Dimensions

(1) Package Type: TSOT25

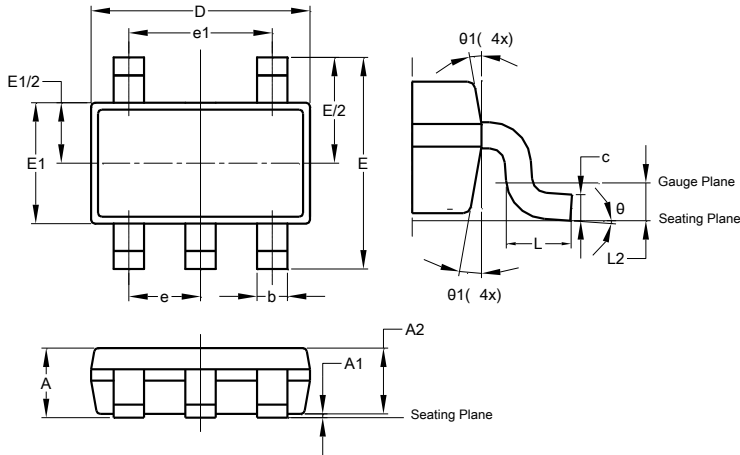

TSOT25			
Dim	Min	Max	Typ
A	-	1.00	-
A1	0.01	0.10	-
A2	0.84	0.90	-
b	0.30	0.45	-
c	0.12	0.20	-
D	-	-	2.90
E	-	-	2.80
E1	-	-	1.60
e	0.95 BSC		
e1	1.90 BSC		
L	0.30	0.50	
L2	0.25 BSC		
theta	0°	8°	4°
theta1	4°	12°	-
All Dimensions in mm			

(2) Package Type: U-DFN2020-6 (Type J)

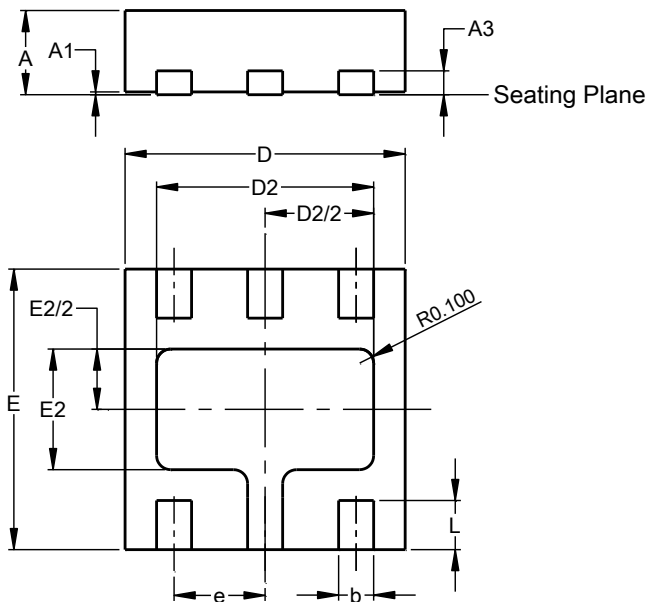

U-DFN2020-6 (Type J)			
Dim	Min	Max	Typ
A	0.50	0.60	--
A1	0.00	0.05	0.03
A3	--	--	0.203
b	0.20	0.30	0.25
D	1.95	2.075	2.00
D2	1.45	1.65	1.55
E	1.95	2.075	2.00
E2	0.76	0.96	0.86
e	0.65 BSC		
L	0.30	0.40	0.35
All Dimensions in mm			

Suggested Pad Layout

(1) Package Type: TSOT25

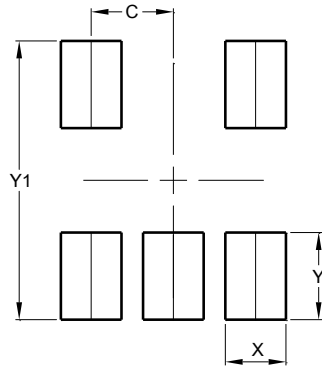

Dimensions	Value (in mm)
C	0.950
X	0.700
Y	1.000
Y1	3.199

(2) Package Type: U-DFN2020-6 (Type J)

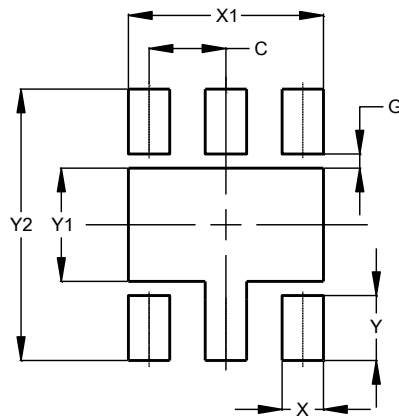

Dimensions	Value (in mm)
C	0.650
G	0.120
X	0.350
X1	1.650
Y	0.550
Y1	0.960
Y2	2.300

IMPORTANT NOTICE

DIODES INCORPORATED MAKES NO WARRANTY OF ANY KIND, EXPRESS OR IMPLIED, WITH REGARDS TO THIS DOCUMENT, INCLUDING, BUT NOT LIMITED TO, THE IMPLIED WARRANTIES OF MERCHANTABILITY AND FITNESS FOR A PARTICULAR PURPOSE (AND THEIR EQUIVALENTS UNDER THE LAWS OF ANY JURISDICTION).

Diodes Incorporated and its subsidiaries reserve the right to make modifications, enhancements, improvements, corrections or other changes without further notice to this document and any product described herein. Diodes Incorporated does not assume any liability arising out of the application or use of this document or any product described herein; neither does Diodes Incorporated convey any license under its patent or trademark rights, nor the rights of others. Any Customer or user of this document or products described herein in such applications shall assume all risks of such use and will agree to hold Diodes Incorporated and all the companies whose products are represented on Diodes Incorporated website, harmless against all damages.

Diodes Incorporated does not warrant or accept any liability whatsoever in respect of any products purchased through unauthorized sales channel. Should Customers purchase or use Diodes Incorporated products for any unintended or unauthorized application, Customers shall indemnify and hold Diodes Incorporated and its representatives harmless against all claims, damages, expenses, and attorney fees arising out of, directly or indirectly, any claim of personal injury or death associated with such unintended or unauthorized application.

Products described herein may be covered by one or more United States, international or foreign patents pending. Product names and markings noted herein may also be covered by one or more United States, international or foreign trademarks.

This document is written in English but may be translated into multiple languages for reference. Only the English version of this document is the final and determinative format released by Diodes Incorporated.

LIFE SUPPORT

Diodes Incorporated products are specifically not authorized for use as critical components in life support devices or systems without the express written approval of the Chief Executive Officer of Diodes Incorporated. As used herein:

A. Life support devices or systems are devices or systems which:

1. are intended to implant into the body, or
2. support or sustain life and whose failure to perform when properly used in accordance with instructions for use provided in the labeling can be reasonably expected to result in significant injury to the user.

B. A critical component is any component in a life support device or system whose failure to perform can be reasonably expected to cause the failure of the life support device or to affect its safety or effectiveness.

Customers represent that they have all necessary expertise in the safety and regulatory ramifications of their life support devices or systems, and acknowledge and agree that they are solely responsible for all legal, regulatory and safety-related requirements concerning their products and any use of Diodes Incorporated products in such safety-critical, life support devices or systems, notwithstanding any devices- or systems-related information or support that may be provided by Diodes Incorporated. Further, Customers must fully indemnify Diodes Incorporated and its representatives against any damages arising out of the use of Diodes Incorporated products in such safety-critical, life support devices or systems.

Copyright © 2016, Diodes Incorporated

www.diodes.com

Компания «Океан Электроники» предлагает заключение долгосрочных отношений при поставках импортных электронных компонентов на взаимовыгодных условиях!

Наши преимущества:

- Поставка оригинальных импортных электронных компонентов напрямую с производств Америки, Европы и Азии, а так же с крупнейших складов мира;
- Широкая линейка поставок активных и пассивных импортных электронных компонентов (более 30 млн. наименований);
- Поставка сложных, дефицитных, либо снятых с производства позиций;
- Оперативные сроки поставки под заказ (от 5 рабочих дней);
- Экспресс доставка в любую точку России;
- Помощь Конструкторского Отдела и консультации квалифицированных инженеров;
- Техническая поддержка проекта, помощь в подборе аналогов, поставка прототипов;
- Поставка электронных компонентов под контролем ВП;
- Система менеджмента качества сертифицирована по Международному стандарту ISO 9001;
- При необходимости вся продукция военного и аэрокосмического назначения проходит испытания и сертификацию в лаборатории (по согласованию с заказчиком);
- Поставка специализированных компонентов военного и аэрокосмического уровня качества (Xilinx, Altera, Analog Devices, Intersil, Interpoint, Microsemi, Actel, Aeroflex, Peregrine, VPT, Syfer, Eurofarad, Texas Instruments, MS Kennedy, Miteq, Cobham, E2V, MA-COM, Hittite, Mini-Circuits, General Dynamics и др.);

Компания «Океан Электроники» является официальным дистрибьютором и эксклюзивным представителем в России одного из крупнейших производителей разъемов военного и аэрокосмического назначения «JONHON», а так же официальным дистрибьютором и эксклюзивным представителем в России производителя высокотехнологичных и надежных решений для передачи СВЧ сигналов «FORSTAR».



JONHON

«JONHON» (основан в 1970 г.)

Разъемы специального, военного и аэрокосмического назначения:

(Применяются в военной, авиационной, аэрокосмической, морской, железнодорожной, горно- и нефтедобывающей отраслях промышленности)

«FORSTAR» (основан в 1998 г.)

ВЧ соединители, коаксиальные кабели, кабельные сборки и микроволновые компоненты:

(Применяются в телекоммуникациях гражданского и специального назначения, в средствах связи, РЛС, а так же военной, авиационной и аэрокосмической отраслях промышленности).



Телефон: 8 (812) 309-75-97 (многоканальный)

Факс: 8 (812) 320-03-32

Электронная почта: ocean@oceanchips.ru

Web: <http://oceanchips.ru/>

Адрес: 198099, г. Санкт-Петербург, ул. Калинина, д. 2, корп. 4, лит. А