

POLYSWITCH RESETTABLE DEVICES

Strap Battery Devices

Littelfuse PolySwitch, a pioneer of polymeric positive temperature coefficient (PPTC) resettable devices, offers several material platforms to help protect battery applications. Each of these material platforms offers different performance characteristics that allow the engineer greater design flexibility. PolySwitch devices for battery protection include SRP, LR4, VTP, VLP, VLR, MXP and MGP series, disc and special application strap devices.

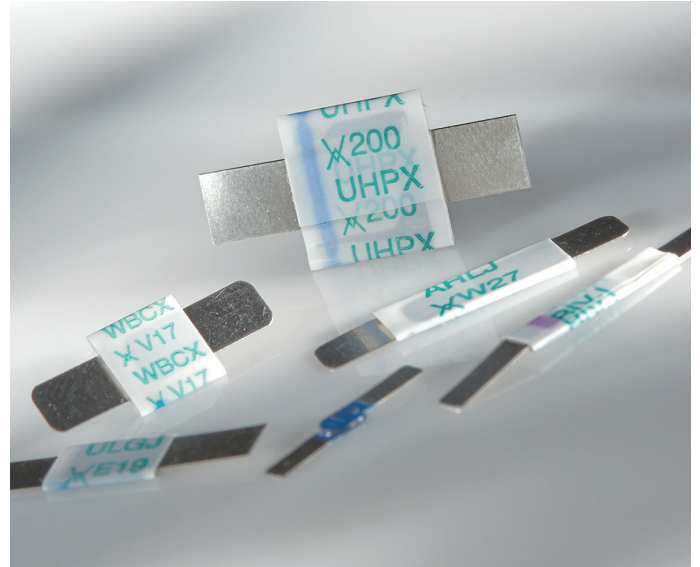

BENEFITS

- Many material platforms and device form factors help provide engineers more design flexibility
- Compatible with high-volume electronics assembly
- Assists in meeting regulatory requirements
- Low-resistance devices increase battery operating time

FEATURES

- RoHS compliant
- Lead-free versions of all devices are available
- Broad range of resettable devices available
- Current ratings from 1.1A to 13A
- Voltage ratings from 6V to 30V
- Agency recognition: UL, CSA, TÜV
- Fast time-to-trip
- Low resistance

APPLICATIONS

- Mobile phone and smart phone battery packs
- Tablet PC battery packs
- Mobile radio battery packs
- Computer battery packs
- Digital camera battery packs
- Portable media player battery packs
- Power tools (charge line)

PolySwitch Resettable Devices

Strap Battery Devices

Application Selection Guide

The guide below lists PolySwitch strap battery devices which are typically used in applications.

The following pages contain the specifications for the part numbers recommended below.

Once a device is selected, the user should evaluate and test each product for its intended application.

| Protection Application | Additional Comments | PolySwitch Resettable Devices — Key Device Selection Criteria | | |
|------------------------------|----------------------|---|--|------------------------|
| | | Installation Method | Lowest Resistance | Lowest Thermal Cut-off |
| Mobile Phone Battery Packs | Li-ion | Surface-mount | Refer to Surface-mount Section of this Catalog | |
| | | Prismatic | MXP370BD | VLR175F |
| Cordless Phone Battery Packs | NiMH | Cylindrical | VLP210F | — |
| | | | SRP175F | |
| Mobile Radio Battery Packs | NiMH | Cylindrical | LR4-380F | — |
| | | | SRP350F | |
| Computer Battery Packs | NiMH | Cylindrical | LR4-900F | — |
| | Li-ion | Cylindrical | LR4-1300SSF | — |
| | | Prismatic | Consult Local Rep | Consult Local Rep |
| Camcorder Battery Packs | NiMH or Li-ion | Prismatic | VLP270F | VTP210GF |
| | | | LR4-380F | — |
| PDA Battery Packs | Li-ion | Prismatic | VLP220F | VLR175F |
| Power Tools (Charge Line) | NiCd, NiMH or Li-ion | Cylindrical | Custom LR4 | Custom VTP |

Table B1 — Product Series - Current Rating, Voltage Rating /Typical Resistance

| Hold Current (A) | VLR | VLP | VTP | MXP | SRP | LR4 |
|------------------|--------------------------------|------------|------------|------------|------------|------------|
| | Typical Activation Temperature | | | | | |
| | 85°C | 90°C | 90°C | 120°C | 125°C | 125°C |
| 1.10 | — | — | 16V/0.054Ω | — | — | — |
| 1.20 | — | 16V/0.053Ω | — | — | 15V/0.123Ω | — |
| 1.70 | 12V/0.025Ω | — | 16V/0.041Ω | — | — | — |
| 1.75 | 12V/0.024Ω | 16V/0.032Ω | 16V/0.040Ω | — | 15V/0.070Ω | — |
| 1.80 | — | — | — | 6V/0.0105Ω | — | — |
| 1.90 | — | — | — | 6V/0.011Ω | — | 15V/0.056Ω |
| 2.00 | — | — | — | — | 30V/0.045Ω | — |
| 2.10 | — | 16V/0.024Ω | 16V/0.024Ω | — | — | — |
| 2.20 | — | 16V/0.023Ω | — | — | — | — |
| 2.30 | 12V/0.015Ω | — | — | — | — | — |
| 2.50 | — | — | — | 6V/0.011Ω | — | — |
| 2.60 | — | — | — | — | — | 15V/0.031Ω |
| 2.70 | — | 16V/0.015Ω | — | 6V/0.0105Ω | — | — |
| 3.10 | — | — | — | 6V/0.0075Ω | — | — |
| 3.50 | — | — | — | — | 30V/0.024Ω | — |
| 3.70 | — | — | — | 6V/0.007Ω | — | — |
| 3.80 | — | — | — | — | — | 15V/0.020Ω |
| 4.20 | — | — | — | — | 30V/0.018Ω | — |
| 4.50 | — | — | — | — | — | 20V/0.016Ω |
| 5.50 | — | — | — | — | — | 20V/0.013Ω |
| 6.00 | — | — | — | — | — | 20V/0.011Ω |
| 7.30 | — | — | — | — | — | 20V/0.009Ω |
| 9.00 | — | — | — | — | — | 20V/0.008Ω |
| 13.00 | — | — | — | — | — | 20V/0.006Ω |

PolySwitch Resettable Devices

Strap Battery Devices

Table B2 – Thermal Derating [Hold Current (A) at Ambient Temperature (°C)]

| Part Number | Maximum Ambient Temperature | | | | | | | | | | | | |
|---------------------------------|-----------------------------|-------|------|------|-------|------|------|------|------|------|------|------|------|
| | -40°C A | -20°C | 0°C | 20°C | 25°C | 40°C | 50°C | 60°C | 70°C | 80°C | 85°C | | |
| 85°C Typical Activation | | | | | | | | | | | | | |
| VLR* | | | | | | | | | | | | | |
| VLR170F | 3.5 | 2.9 | 2.4 | 1.84 | 1.70 | 1.2 | 1.0 | 0.7 | 0.3 | — | — | | |
| VLR175F | 3.5 | 2.9 | 2.4 | 1.87 | 1.75 | 1.3 | 1.0 | 0.8 | 0.3 | — | — | | |
| VLR175LF | 3.5 | 2.9 | 2.4 | 1.87 | 1.75 | 1.3 | 1.0 | 0.8 | 0.3 | — | — | | |
| VLR230F | 5.0 | 4.2 | 3.4 | 2.52 | 2.30 | 1.7 | 1.3 | 0.9 | 0.4 | — | — | | |
| 90°C Typical Activation | | | | | | | | | | | | | |
| VLP* | | | | | | | | | | | | | |
| VLP120UF | 2.4 | 2.1 | 1.8 | 1.30 | 1.20 | 1.0 | 0.7 | 0.6 | 0.3 | 0.2 | 0.1 | | |
| VLP175UAF | 3.2 | 2.7 | 2.3 | 1.70 | 1.75 | 1.2 | 1.0 | 0.9 | 0.5 | 0.2 | 0.1 | | |
| VLP210F | 4.3 | 3.6 | 2.9 | 2.31 | 2.10 | 1.6 | 1.3 | 1.0 | 0.6 | 0.3 | 0.1 | | |
| VLP220F | 4.5 | 3.8 | 3.0 | 2.45 | 2.20 | 1.7 | 1.4 | 1.1 | 0.7 | 0.3 | 0.1 | | |
| VLP270F | 5.6 | 4.7 | 4.0 | 3.05 | 2.70 | 2.2 | 1.7 | 1.4 | 0.9 | 0.4 | 0.1 | | |
| VTP* | | | | | | | | | | | | | |
| VTP110F | 2.0 | 1.7 | 1.4 | 1.12 | 1.10 | 0.85 | 0.75 | 0.7 | 0.4 | 0.2 | 0.1 | | |
| VTP170F | 3.2 | 2.7 | 2.2 | 1.80 | 1.70 | 1.3 | 1.0 | 0.8 | 0.5 | 0.3 | 0.1 | | |
| VTP170XSF | 3.2 | 2.7 | 2.2 | 1.80 | 1.70 | 1.3 | 1.0 | 0.8 | 0.5 | 0.3 | 0.1 | | |
| VTP175F | 3.2 | 2.7 | 2.2 | 1.84 | 1.75 | 1.3 | 1.0 | 0.8 | 0.5 | 0.3 | 0.1 | | |
| VTP175LF | 3.2 | 2.7 | 2.2 | 1.84 | 1.75 | 1.3 | 1.0 | 0.8 | 0.5 | 0.3 | 0.1 | | |
| VTP210GF | 4.1 | 3.5 | 2.9 | 2.26 | 2.10 | 1.6 | 1.3 | 1.0 | 0.7 | 0.4 | 0.1 | | |
| VTP210SF | 4.1 | 3.5 | 2.9 | 2.26 | 2.10 | 1.6 | 1.3 | 1.0 | 0.7 | 0.4 | 0.1 | | |
| Part Number | Maximum Ambient Temperature | | | | | | | | | | | | |
| | -40°C A | -20°C | 0°C | 20°C | 25°C | 40°C | 50°C | 60°C | 70°C | 75°C | 80°C | 85°C | 90°C |
| 120°C Typical Activation | | | | | | | | | | | | | |
| MXP* | | | | | | | | | | | | | |
| MXP180 | — | — | 2.45 | — | 1.8 | — | — | 0.80 | — | — | — | — | — |
| MXP190BB | — | — | 2.6 | — | 1.9 | — | — | 0.85 | — | — | — | — | — |
| MXP250K | — | — | 3.6 | — | 2.5 | — | — | 1.3 | — | — | — | — | — |
| MXP270 | — | — | 3.8 | — | 2.7 | — | — | 1.4 | — | — | — | — | 0.3 |
| MXP310 | — | — | 5.0 | — | 3.1 | — | — | 1.9 | — | 1.0 | — | — | — |
| MXP370BD | — | — | 5.0 | — | 3.7 | — | — | 1.9 | — | — | — | — | — |
| 120°C Typical Activation | | | | | | | | | | | | | |
| MGP | | | | | | | | | | | | | |
| MGP450 | — | — | — | — | 4.5 | — | — | 2.6 | — | — | — | — | — |
| MGP500 | — | — | — | — | 5.0 | — | — | 3.0 | 2.0 | — | — | — | — |
| Part Number | Maximum Ambient Temperature | | | | | | | | | | | | |
| | -40°C A | -20°C | 0°C | 20°C | 25°C | 40°C | 50°C | 60°C | 70°C | 80°C | 85°C | | |
| 125°C Typical Activation | | | | | | | | | | | | | |
| SRP | | | | | | | | | | | | | |
| SRP120F | 1.9 | 1.7 | 1.5 | 1.20 | 1.17 | 1.0 | 0.9 | 0.8 | 0.6 | 0.5 | 0.4 | | |
| SRP175F | 2.5 | 2.2 | 2.0 | 1.75 | 1.68 | 1.4 | 1.3 | 1.2 | 1.0 | 0.9 | 0.8 | | |
| SRP200F | 3.1 | 2.8 | 2.5 | 2.00 | 1.97 | 1.7 | 1.5 | 1.4 | 1.2 | 1.0 | 0.9 | | |
| SRP350F | 5.3 | 4.8 | 4.3 | 3.50 | 3.44 | 3.0 | 2.7 | 2.5 | 2.1 | 1.8 | 1.7 | | |
| SRP420F | 6.3 | 5.7 | 5.1 | 4.20 | 4.11 | 3.6 | 3.3 | 3.0 | 2.6 | 2.2 | 2.1 | | |
| LR4 | | | | | | | | | | | | | |
| LR4-190F | 2.8 | 2.5 | 2.3 | 1.9 | 1.86 | 1.6 | 1.5 | 1.4 | 1.2 | 1.1 | 1.0 | | |
| LR4-260F | 3.8 | 3.4 | 3.1 | 2.6 | 2.54 | 2.2 | 2.0 | 1.9 | 1.7 | 1.4 | 1.3 | | |
| LR4-380F | 5.4 | 4.9 | 4.4 | 3.8 | 3.64 | 3.3 | 3.0 | 2.8 | 2.5 | 2.3 | 2.1 | | |
| LR4-380XF | 5.4 | 4.9 | 4.4 | 3.8 | 3.64 | 3.3 | 3.0 | 2.8 | 2.5 | 2.3 | 2.1 | | |
| LR4-450F | 6.5 | 5.8 | 5.3 | 4.5 | 4.38 | 3.9 | 3.6 | 3.3 | 2.9 | 2.6 | 2.4 | | |
| LR4-550F | 7.6 | 6.9 | 6.2 | 5.5 | 5.32 | 4.7 | 4.3 | 4.0 | 3.6 | 3.2 | 3.0 | | |
| LR4-600F | 8.7 | 7.8 | 7.1 | 6.0 | 5.86 | 5.2 | 4.7 | 4.4 | 3.9 | 3.4 | 3.2 | | |
| LR4-600XF | 8.7 | 7.8 | 7.1 | 6.0 | 5.86 | 5.2 | 4.7 | 4.4 | 3.9 | 3.4 | 3.2 | | |
| LR4-730F | 10.5 | 9.5 | 8.6 | 7.3 | 7.13 | 6.3 | 5.7 | 5.4 | 4.7 | 4.2 | 4.0 | | |
| LR4-900F | 12.7 | 11.4 | 10.0 | 9.0 | 8.50 | 7.5 | 6.8 | 6.2 | 5.5 | 4.9 | 4.5 | | |
| LR4-1300SSF | 17.9 | 16.2 | 14.5 | 13.0 | 12.40 | 11.1 | 10.3 | 9.5 | 8.6 | 7.7 | 7.2 | | |

* Product electrical characteristics determined at 25°C.

PolySwitch Resettable Devices

Strap Battery Devices

Figure B1 – Thermal Derating Curve

- A = LR4
- B = SRP
- C = VTP, VLP, MXP
- D = MGP
- E = VLR
- F = RSD

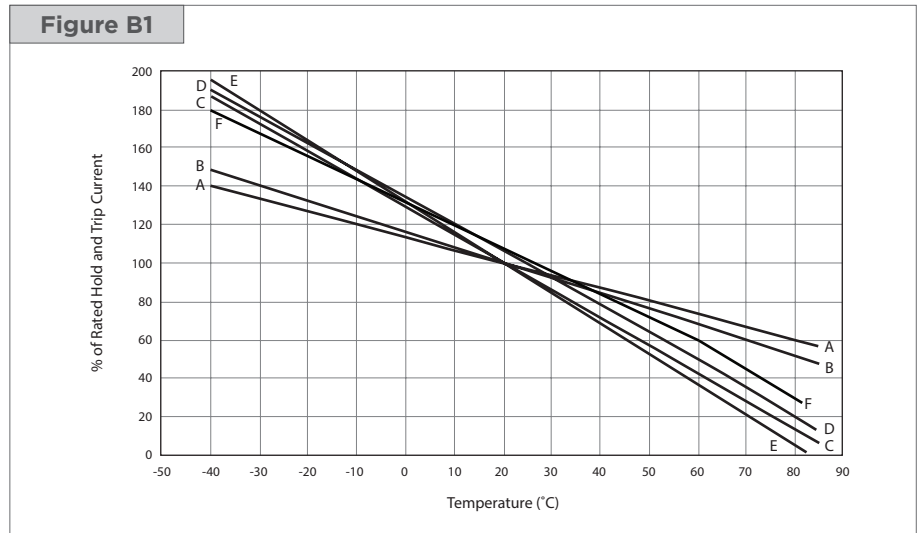

Table B3 – Electrical Characteristics

| Part Number | I _H (A) | I _T (A) | V _{MAX} (V _{DC}) | I _{MAX} (A) | P _{D MAX} (W) | Max Time-to-trip | | R _{MIN} (Ω) | R _{MAX} (Ω) | R _{1MAX} (Ω) | Figure for Dimension |
|---------------------------------|-----------------------|-----------------------|--|-------------------------|---------------------------|------------------|-----|-------------------------|-------------------------|--------------------------|----------------------|
| | | | | | | (A) | (s) | | | | |
| 85°C Typical Activation | | | | | | | | | | | |
| VLR* | | | | | | | | | | | |
| VLR170F | 1.70 | 4.1 | 12 | 100 | 1.4 | 8.50 | 5.0 | 0.018 | 0.032 | 0.064 | B3 |
| VLR175F | 1.75 | 4.2 | 12 | 100 | 1.4 | 8.75 | 5.0 | 0.017 | 0.031 | 0.062 | B3 |
| VLR175LF | 1.75 | 4.2 | 12 | 100 | 1.4 | 8.75 | 5.0 | 0.017 | 0.031 | 0.062 | B3 |
| VLR230F | 2.30 | 5.0 | 12 | 100 | 2.5 | 10.00 | 5.0 | 0.012 | 0.018 | 0.036 | B3 |
| 90°C Typical Activation | | | | | | | | | | | |
| VLP* | | | | | | | | | | | |
| VLP120UF | 1.20 | 3.6 | 16 | 60 | 1.6 | 7.00 | 5.0 | 0.039 | 0.067 | 0.134 | B5 |
| VLP175UAF | 1.75 | 3.9 | 16 | 60 | 1.8 | 8.75 | 5.0 | 0.023 | 0.041 | 0.082 | B5 |
| VLP210F | 2.10 | 5.0 | 16 | 60 | 1.8 | 10.50 | 5.0 | 0.018 | 0.030 | 0.060 | B2 |
| VLP220F | 2.20 | 5.3 | 16 | 60 | 1.8 | 11.00 | 5.0 | 0.017 | 0.029 | 0.058 | B3 |
| VLP270F | 2.70 | 6.5 | 16 | 60 | 2.5 | 13.50 | 5.0 | 0.012 | 0.018 | 0.036 | B3 |
| VTP* | | | | | | | | | | | |
| VTP110F | 1.10 | 2.7 | 16 | 100 | 1.3 | 5.50 | 5.0 | 0.038 | 0.070 | 0.140 | B5 |
| VTP170F | 1.70 | 3.4 | 16 | 100 | 1.4 | 8.50 | 5.0 | 0.030 | 0.052 | 0.105 | B2 |
| VTP170XSF | 1.70 | 3.4 | 16 | 100 | 1.4 | 8.50 | 5.0 | 0.030 | 0.052 | 0.105 | B4 |
| VTP175F | 1.75 | 3.6 | 16 | 100 | 1.4 | 8.75 | 5.0 | 0.029 | 0.051 | 0.102 | B3 |
| VTP175LF | 1.75 | 3.6 | 16 | 100 | 1.4 | 8.75 | 5.0 | 0.029 | 0.051 | 0.102 | B3 |
| VTP210GF | 2.10 | 4.7 | 16 | 100 | 1.5 | 10.00 | 5.0 | 0.018 | 0.030 | 0.060 | B3 |
| VTP210SF | 2.10 | 4.7 | 16 | 100 | 1.5 | 10.00 | 5.0 | 0.018 | 0.030 | 0.060 | B4 |
| 120°C Typical Activation | | | | | | | | | | | |
| MXP* | | | | | | | | | | | |
| MXP180 | 1.80 | 5.2 | 6 | 50 | 1.0 | 9.00 | 5.0 | 0.007 | 0.014 | 0.024 | B10 |
| MXP190BB | 1.90 | 4.9 | 6 | 50 | 1.0 | 9.50 | 2.0 | 0.007 | 0.015 | 0.024 | B9 |
| MXP250K | 2.50 | 6.2 | 6 | 50 | 1.0 | 13.50 | 2.0 | 0.006 | 0.016 | 0.028 | B10 |
| MXP270 | 2.70 | 6.2 | 6 | 50 | 1.0 | 13.50 | 2.0 | 0.006 | 0.015 | 0.026 | B10 |
| MXP310 | 3.10 | 9.0 | 6 | 50 | 1.3 | 17.50 | 5.0 | 0.003 | 0.012 | 0.018 | B10 |
| MXP370BD | 3.70 | 9.0 | 6 | 50 | 1.3 | 18.50 | 5.0 | 0.004 | 0.010 | 0.016 | B10 |

* Product electrical characteristics determined at 25°C.

PolySwitch Resettable Devices

Strap Battery Devices

Table B3 – Electrical Characteristics

(Cont'd)

| Part Number | I_H (A) | I_T (A) | V_{MAX} (V _{DC}) | I_{MAX} (A) | $P_{D MAX}$ (W) | Max Time-to-trip | | R_{MIN} (Ω) | R_{MAX} (Ω) | R_{1MAX} (Ω) | Figure for Dimension |
|---------------------------------|--------------|--------------|---------------------------------|------------------|--------------------|------------------|------|------------------|------------------|-------------------|----------------------|
| | | | | | | (A) | (s) | | | | |
| 120°C Typical Activation | | | | | | | | | | | |
| MGP | | | | | | | | | | | |
| MGP450 | 4.50 | 9.2 | 6 | 50 | 1.5 | 25.00 | 5.0 | 0.0025 | 0.007 | 0.013 | B11 |
| MGP500 | 5.00 | 9.2 | 6 | 50 | 1.5 | 25.00 | 5.0 | 0.0025 | 0.0065 | 0.013 | B12 |
| 125°C Typical Activation | | | | | | | | | | | |
| SRP | | | | | | | | | | | |
| SRP120F | 1.20 | 2.7 | 15 | 100 | 1.2 | 6.00 | 5.0 | 0.085 | 0.160 | 0.220 | B6 |
| SRP175F | 1.75 | 3.8 | 15 | 100 | 1.5 | 8.75 | 5.0 | 0.050 | 0.090 | 0.120 | B6 |
| SRP200F | 2.00 | 4.4 | 30 | 100 | 1.9 | 10.00 | 4.0 | 0.030 | 0.060 | 0.100 | B6 |
| SRP350F | 3.50 | 6.3 | 30 | 100 | 2.5 | 20.00 | 3.0 | 0.017 | 0.031 | 0.050 | B6 |
| SRP420F | 4.20 | 7.6 | 30 | 100 | 2.9 | 20.00 | 6.0 | 0.012 | 0.024 | 0.040 | B6 |
| LR4 | | | | | | | | | | | |
| LR4-190F | 1.90 | 3.9 | 15 | 100 | 1.2 | 9.5 | 5.0 | 0.0390 | 0.0720 | 0.102 | B7 |
| LR4-260F | 2.60 | 5.8 | 15 | 100 | 2.5 | 13.0 | 5.0 | 0.0200 | 0.0420 | 0.063 | B7 |
| LR4-380F | 3.80 | 8.3 | 15 | 100 | 2.5 | 19.0 | 5.0 | 0.0130 | 0.0260 | 0.037 | B7 |
| LR4-380XF | 3.80 | 8.3 | 15 | 100 | 2.5 | 19.0 | 5.0 | 0.0130 | 0.0260 | 0.037 | B7 |
| LR4-450F | 4.50 | 8.9 | 20 | 100 | 2.3 | 22.5 | 5.0 | 0.0110 | 0.0200 | 0.028 | B7 |
| LR4-550F | 5.50 | 10.5 | 20 | 100 | 2.8 | 27.5 | 5.0 | 0.0090 | 0.0160 | 0.022 | B7 |
| LR4-600F | 6.00 | 11.7 | 20 | 100 | 2.8 | 30.0 | 5.0 | 0.0070 | 0.0140 | 0.019 | B7 |
| LR4-600XF | 6.00 | 11.7 | 20 | 100 | 2.8 | 30.0 | 5.0 | 0.0075 | 0.0140 | 0.019 | B7 |
| LR4-730F | 7.30 | 14.1 | 20 | 100 | 3.3 | 30.0 | 5.0 | 0.0060 | 0.0120 | 0.015 | B7 |
| LR4-900F | 9.00 | 16.7 | 20 | 100 | 3.8 | 45.0 | 5.0 | 0.0060 | 0.0100 | 0.014 | B7 |
| LR4-1300SSF | 13.00 | 21.2 | 20 | 100 | 4.5 | 50.0 | 10.0 | 0.0035 | 0.0065 | 0.009 | B8 |

* Product electrical characteristics determined at 25°C.

Notes

- I_H : Hold current: maximum current device will pass without interruption in 20°C still air unless otherwise specified.
- I_T : Trip current: minimum current that will switch the device from low-resistance to high-resistance in 20°C still air unless otherwise specified.
- V_{MAX} : Maximum voltage device can withstand without damage at rated current.
- I_{MAX} : Maximum fault current device can withstand without damage at rated voltage.
- P_D : Power dissipated from device when in the tripped state in 20°C still air unless otherwise specified.
- R_{MIN} : Minimum resistance of device as supplied at 20°C unless otherwise specified.
- R_{MAX} : Maximum resistance of device as supplied at 20°C unless otherwise specified.
- R_{1MAX} : Maximum resistance, measured at 20°C unless otherwise specified, of device one hour after being tripped the first time.

Figures B2-B12 – Dimension Figures

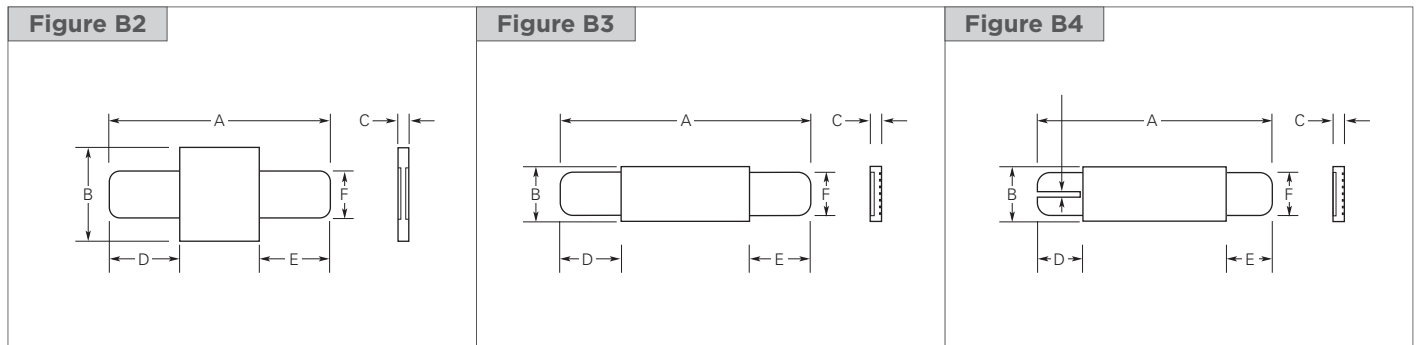

PolySwitch Resettable Devices

Strap Battery Devices

Figures B2-B12 – Dimension Figures

(Cont'd)

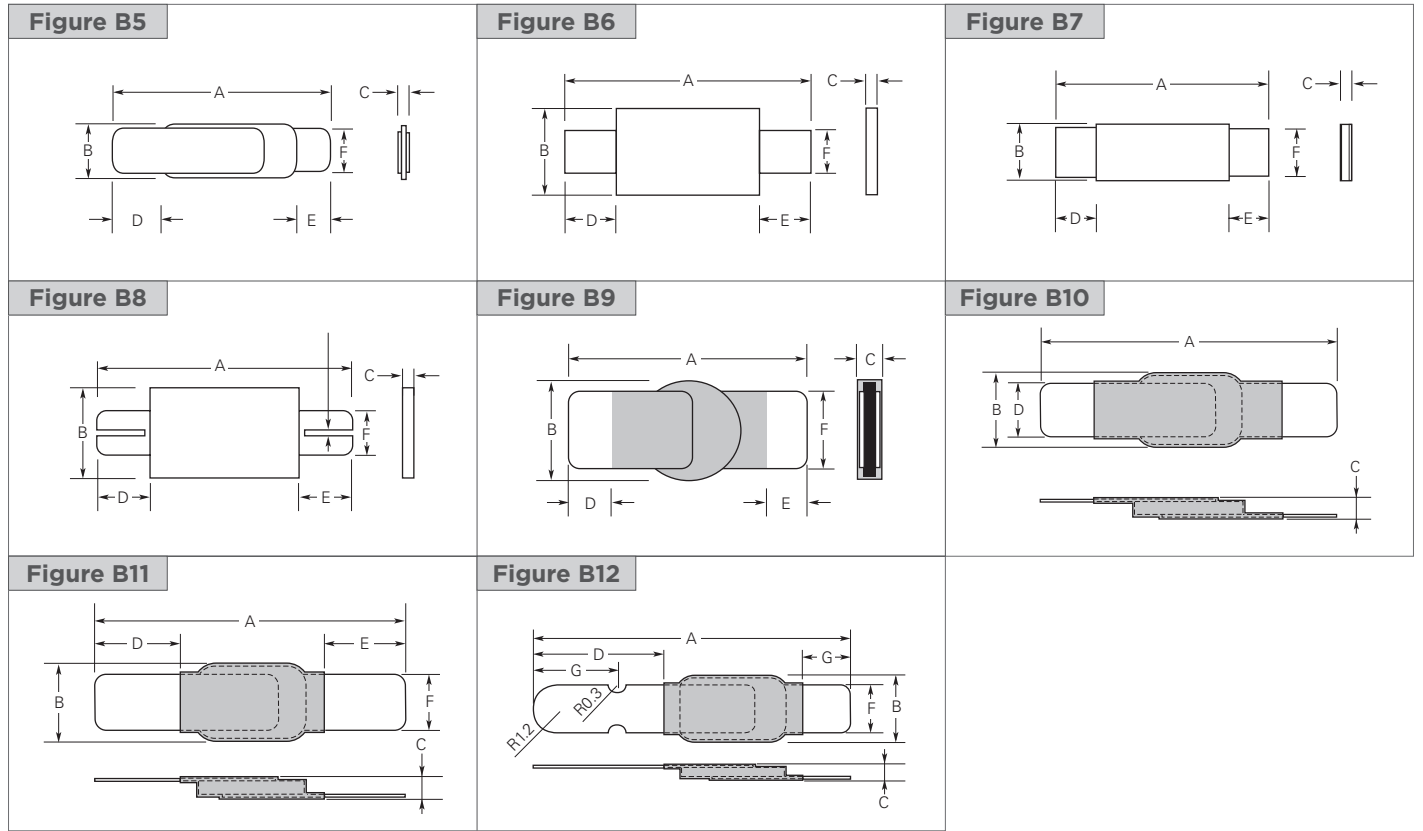

Table B4 – Dimensions in Millimeters (Inches)

| Part Number | A | | B | | C | | D | | E | | F | | G | | Figure |
|--------------------------------|-----------------|-----------------|----------------|----------------|----------------|----------------|----------------|----------------|-----------------|-----------------|----------------|----------------|-----|-----|--------|
| | Min | Max | Min | Max | Min | Max | Min | Max | Min | Max | Min | Max | Min | Max | |
| 85°C Typical Activation | | | | | | | | | | | | | | | |
| VLR | | | | | | | | | | | | | | | |
| VLR170F | 20.8 (0.832) | 23.2 (0.928) | 3.5 (0.140) | 3.9 (0.156) | — | 0.8 (0.032) | 4.5 (0.180) | 6.5 (0.260) | 4.5 (0.180) | 6.5 (0.260) | 2.4 (0.096) | 2.6 (0.104) | — | — | B3 |
| VLR175F | 23.0 (0.920) | 24.5 (0.980) | 2.9 (0.116) | 3.3 (0.132) | 0.5 (0.020) | 0.8 (0.032) | 4.7 (0.188) | 7.2 (0.288) | 3.8 (0.152) | 5.4 (0.216) | 2.4 (0.096) | 2.6 (0.104) | — | — | B3 |
| VLR175LF | 29.3 (1.172) | 31.7 (1.268) | 2.9 (0.116) | 3.3 (0.132) | — | 0.8 (0.032) | 5.2 (0.208) | 6.8 (0.272) | 10 (0.400) | 12.5 (0.500) | 2.4 (0.096) | 2.6 (0.104) | — | — | B3 |
| VLR230F | 20.9 (0.836) | 23.1 (0.924) | 4.9 (0.196) | 5.3 (0.212) | — | 0.8 (0.032) | 4.1 (0.164) | 5.8 (0.232) | 4.1 (0.164) | 5.8 (0.232) | 3.9 (0.156) | 4.1 (0.164) | — | — | B3 |
| 90°C Typical Activation | | | | | | | | | | | | | | | |
| VLP | | | | | | | | | | | | | | | |
| VLP120UF | 10.9 (0.430) | 11.8 (0.460) | 4.4 (0.170) | 4.6 (0.180) | — | 0.7 (0.028) | 5.5 (0.220) | 6.5 (0.260) | 1.65 (0.065) | 1.9 (0.075) | 2.3 (0.091) | 2.5 (0.098) | — | — | B5 |
| VLP175UAF | 23.6 (0.944) | 25.6 (1.024) | 2.7 (0.108) | 2.9 (0.116) | — | 0.7 (0.028) | 7.0 (0.280) | 8.0 (0.320) | 7.0 (0.280) | 8.0 (0.320) | 2.3 (0.092) | 2.5 (0.100) | — | — | B5 |
| VLP210F | 15.4 (0.616) | 17.5 (0.700) | 6.9 (0.276) | 7.3 (0.292) | 0.6 (0.024) | 0.8 (0.032) | 4.0 (0.160) | 6.2 (0.248) | 4.0 (0.160) | 6.2 (0.248) | 3.9 (0.156) | 4.1 (0.164) | — | — | B2 |
| VLP220F | 21.1 (0.844) | 23.3 (0.932) | 3.5 (0.140) | 3.9 (0.156) | 0.6 (0.024) | 0.8 (0.032) | 5.1 (0.204) | 6.8 (0.272) | 5.1 (0.204) | 6.8 (0.272) | 2.9 (0.116) | 3.1 (0.124) | — | — | B3 |
| VLP270F | 20.9 (0.836) | 23.1 (0.924) | 4.9 (0.196) | 5.3 (0.212) | 0.6 (0.024) | 0.8 (0.032) | 4.1 (0.164) | 5.8 (0.232) | 4.1 (0.164) | 5.8 (0.232) | 3.9 (0.156) | 4.1 (0.164) | — | — | B3 |

PolySwitch Resettable Devices

Strap Battery Devices

Table B4 – Dimensions in Millimeters (Inches)

(Cont'd)

| Part Number | A | | B | | C | | D | | E | | F | | G | | Figure |
|---------------------------------|-----------------|-----------------|-----------------|-----------------|----------------|----------------|----------------|----------------|----------------|-----------------|----------------|----------------|----------------|----------------|--------|
| | Min | Max | Min | Max | Min | Max | Min | Max | Min | Max | Min | Max | Min | Max | |
| VTP | | | | | | | | | | | | | | | |
| VTP110F | 23.6 (0.944) | 25.6 (1.024) | 2.7 (0.108) | 2.9 (0.116) | — (0.028) | 0.7 (0.028) | 7.0 (0.280) | 8.0 (0.320) | 7.0 (0.280) | 8.0 (0.320) | 2.3 (0.092) | 2.5 (0.100) | — (0.000) | — (0.000) | B5 |
| VTP170F | 15.4 (0.616) | 17.5 (0.700) | 7.0 (0.280) | 7.4 (0.296) | 0.5 (0.020) | 0.8 (0.032) | 4.0 (0.160) | 6.2 (0.248) | 4.0 (0.160) | 6.2 (0.248) | 3.9 (0.156) | 4.1 (0.164) | — (0.000) | — (0.000) | B2 |
| VTP170XSF | 20.9 (0.836) | 22.9 (0.916) | 4.9 (0.196) | 5.3 (0.212) | 0.5 (0.020) | 0.8 (0.032) | 6.0 (0.240) | 8.6 (0.344) | 6.0 (0.240) | 8.6 (0.344) | 3.9 (0.156) | 4.1 (0.164) | — (0.000) | — (0.000) | B4 |
| VTP175F | 21.2 (0.848) | 23.2 (0.928) | 3.5 (0.140) | 3.9 (0.156) | — (0.032) | 0.8 (0.032) | 4.6 (0.184) | 6.6 (0.264) | 4.6 (0.184) | 6.6 (0.264) | 2.9 (0.116) | 3.1 (0.124) | — (0.000) | — (0.000) | B3 |
| VTP175LF | 25.8 (1.032) | 28.2 (1.128) | 3.5 (0.140) | 3.9 (0.156) | — (0.032) | 0.8 (0.032) | 5.7 (0.228) | 7.3 (0.292) | 8.7 (0.348) | 10.3 (0.412) | 2.4 (0.096) | 2.6 (0.104) | — (0.000) | — (0.000) | B3 |
| VTP210GF | 20.9 (0.836) | 23.1 (0.924) | 4.9 (0.196) | 5.3 (0.212) | — (0.032) | 0.8 (0.032) | 4.1 (0.164) | 5.8 (0.232) | 4.1 (0.164) | 5.8 (0.232) | 3.9 (0.156) | 4.1 (0.164) | — (0.000) | — (0.000) | B3 |
| VTP210SF | 20.9 (0.836) | 23.1 (0.924) | 4.9 (0.196) | 5.3 (0.212) | 0.6 (0.024) | 0.8 (0.032) | 4.1 (0.164) | 5.8 (0.232) | 4.1 (0.164) | 5.8 (0.232) | 3.9 (0.156) | 4.1 (0.164) | — (0.000) | — (0.000) | B4 |
| 120°C Typical Activation | | | | | | | | | | | | | | | |
| MXP | | | | | | | | | | | | | | | |
| MXP180 | 9.4 (0.37) | 10.0 (0.39) | 2.3 (0.09) | 2.6 (0.10) | 0.7 (0.02) | 1.1 (0.04) | 1.9 (0.07) | 2.1 (0.08) | — (0.000) | — (0.000) | — (0.000) | — (0.000) | — (0.000) | — (0.000) | B10 |
| MXP190BB | 9.2 (0.36) | 10.8 (0.43) | 2.96 (0.12) | 3.26 (0.13) | 0.7 (0.03) | 1.1 (0.04) | 1.6 (0.06) | 3.1 (0.12) | 1.6 (0.06) | 3.1 (0.12) | 2.2 (0.09) | 2.4 (0.10) | — (0.000) | — (0.000) | B9 |
| MXP250K | 11.75 (0.46) | 12.35 (0.49) | 2.3 (0.09) | 2.7 (0.11) | 0.7 (0.03) | 1.1 (0.04) | 2.4 (0.09) | 2.6 (0.10) | — (0.000) | — (0.000) | — (0.000) | — (0.000) | — (0.000) | — (0.000) | B10 |
| MXP270 | 10.3 (0.40) | 11.5 (0.45) | 2.3 (0.09) | 2.7 (0.10) | 0.7 (0.02) | 1.1 (0.04) | 2.1 (0.08) | — (0.000) | 2.1 (0.08) | — (0.000) | 1.9 (0.07) | 2.1 (0.08) | — (0.000) | — (0.000) | B9 |
| MXP310 | 14.5 (0.57) | 16.5 (0.65) | 2.96 (0.11) | 3.26 (0.13) | 0.65 (0.03) | 0.95 (0.04) | 4.6 (0.18) | — (0.000) | 4.6 (0.18) | — (0.000) | 2.2 (0.09) | 2.4 (0.10) | — (0.000) | — (0.000) | B9 |
| MXP370BD | 10.5 (0.41) | 11.3 (0.44) | 2.96 (0.11) | 3.26 (0.12) | 0.7 (0.02) | 1.1 (0.04) | 2.0 (0.07) | — (0.000) | 2.0 (0.07) | — (0.000) | 2.2 (0.08) | 2.4 (0.09) | — (0.000) | — (0.000) | B9 |
| 120°C Typical Activation | | | | | | | | | | | | | | | |
| MGP | | | | | | | | | | | | | | | |
| MGP450 | 13.0 (0.51) | 14.0 (0.55) | 2.96 (0.12) | 3.26 (0.13) | — (0.04) | 0.95 (0.04) | 3.0 (0.12) | — (0.000) | 3.0 (0.12) | — (0.000) | 2.2 (0.09) | 2.4 (0.09) | — (0.000) | — (0.000) | B11 |
| MGP500 | 14.5 (0.57) | 15.5 (0.61) | 2.96 (0.12) | 3.26 (0.13) | — (0.04) | 0.95 (0.04) | 5.5 (0.22) | 7.0 (0.28) | 2.0 (0.08) | — (0.000) | 2.3 (0.09) | 2.5 (0.10) | 3.95 (0.16) | 4.05 (0.16) | B12 |
| 125°C Typical Activation | | | | | | | | | | | | | | | |
| SRP | | | | | | | | | | | | | | | |
| SRP120F | 19.9 (0.796) | 22.1 (0.884) | 4.9 (0.196) | 5.2 (0.208) | 0.6 (0.024) | 1.0 (0.040) | 5.5 (0.220) | 7.5 (0.300) | 5.5 (0.220) | 7.5 (0.300) | 3.9 (0.156) | 4.1 (0.164) | — (0.000) | — (0.000) | B6 |
| SRP175F | 20.9 (0.836) | 23.1 (0.924) | 4.9 (0.196) | 5.2 (0.208) | 0.6 (0.024) | 1.0 (0.040) | 4.1 (0.164) | 5.5 (0.220) | 4.1 (0.164) | 5.5 (0.220) | 3.9 (0.156) | 4.1 (0.164) | — (0.000) | — (0.000) | B6 |
| SRP200F | 21.3 (0.852) | 23.4 (0.936) | 10.2 (0.408) | 11.0 (0.440) | 0.5 (0.020) | 1.1 (0.044) | 5.0 (0.200) | 7.6 (0.304) | 5.0 (0.200) | 7.6 (0.304) | 4.8 (0.192) | 5.4 (0.216) | — (0.000) | — (0.000) | B6 |
| SRP350F | 28.4 (1.136) | 31.8 (1.272) | 13.0 (0.520) | 13.5 (0.540) | 0.5 (0.020) | 1.1 (0.044) | 6.3 (0.252) | 8.9 (0.356) | 6.3 (0.252) | 8.9 (0.356) | 6.0 (0.240) | 6.6 (0.264) | — (0.000) | — (0.000) | B6 |
| SRP420F | 30.6 (1.224) | 32.4 (1.296) | 12.9 (0.516) | 13.6 (0.544) | 0.5 (0.020) | 1.1 (0.044) | 5.0 (0.200) | 7.5 (0.300) | 5.0 (0.200) | 7.5 (0.300) | 6.0 (0.240) | 6.7 (0.268) | — (0.000) | — (0.000) | B6 |

PolySwitch Resettable Devices

Strap Battery Devices

Table B4 – Dimensions in Millimeters (Inches)

(Cont'd)

| Part Number | A | | B | | C | | D | | E | | F | | G | | Figure |
|-------------|-----------------|-----------------|-----------------|-----------------|----------------|----------------|----------------|----------------|----------------|----------------|----------------|----------------|-----|-----|--------|
| | Min | Max | Min | Max | Min | Max | Min | Max | Min | Max | Min | Max | Min | Max | |
| LR4 | | | | | | | | | | | | | | | |
| LR4-190F | 19.9 (0.796) | 22.1 (0.884) | 4.9 (0.196) | 5.5 (0.220) | 0.6 (0.024) | 1.0 (0.040) | 5.5 (0.220) | 7.5 (0.300) | 5.5 (0.220) | 7.5 (0.300) | 3.9 (0.156) | 4.1 (0.164) | — | — | B7 |
| LR4-260F | 20.9 (0.836) | 23.1 (0.924) | 4.9 (0.196) | 5.5 (0.220) | 0.6 (0.024) | 1.0 (0.040) | 4.1 (0.164) | 5.5 (0.220) | 4.1 (0.164) | 5.5 (0.220) | 3.9 (0.156) | 4.1 (0.164) | — | — | B7 |
| LR4-380F | 24.0 (0.960) | 26.0 (1.040) | 6.9 (0.276) | 7.5 (0.300) | 0.6 (0.024) | 1.0 (0.040) | 4.1 (0.164) | 5.5 (0.220) | 4.1 (0.164) | 5.5 (0.220) | 4.9 (0.196) | 5.1 (0.204) | — | — | B7 |
| LR4-380XF | 32.2 (1.288) | 35.8 (1.432) | 4.9 (0.196) | 5.5 (0.220) | 0.6 (0.024) | 1.0 (0.040) | 5.5 (0.220) | 7.5 (0.300) | 5.5 (0.220) | 7.5 (0.300) | 3.9 (0.156) | 4.1 (0.164) | — | — | B7 |
| LR4-450F | 24.0 (0.960) | 26 (1.040) | 9.9 (0.396) | 10.5 (0.420) | 0.6 (0.024) | 1.0 (0.040) | 5.3 (0.212) | 6.7 (0.268) | 5.3 (0.212) | 6.7 (0.268) | 5.9 (0.236) | 6.1 (0.244) | — | — | B7 |
| LR4-550F | 35.0 (1.400) | 37.0 (1.480) | 6.9 (0.276) | 7.5 (0.300) | 0.6 (0.024) | 1.0 (0.040) | 5.3 (0.212) | 6.7 (0.268) | 5.3 (0.212) | 6.7 (0.268) | 4.9 (0.196) | 5.1 (0.204) | — | — | B7 |
| LR4-600F | 24.0 (0.960) | 26.0 (1.040) | 13.9 (0.556) | 14.5 (0.580) | 0.6 (0.024) | 1.0 (0.040) | 4.1 (0.164) | 5.5 (0.220) | 4.1 (0.164) | 5.5 (0.220) | 5.9 (0.236) | 6.1 (0.244) | — | — | B7 |
| LR4-600XF | 40.5 (1.620) | 42.7 (1.708) | 6.9 (0.276) | 7.5 (0.300) | 0.6 (0.024) | 1.0 (0.040) | 5.2 (0.208) | 6.8 (0.272) | 5.2 (0.208) | 6.8 (0.272) | 4.9 (0.196) | 5.1 (0.204) | — | — | B7 |
| LR4-730F | 27.1 (1.084) | 29.1 (1.164) | 13.9 (0.556) | 14.5 (0.580) | 0.6 (0.024) | 1.0 (0.040) | 4.1 (0.164) | 5.5 (0.220) | 4.1 (0.164) | 5.5 (0.220) | 5.9 (0.236) | 6.1 (0.244) | — | — | B7 |
| LR4-900F | 45.4 (1.816) | 47.6 (1.904) | 7.9 (0.316) | 8.5 (0.340) | 0.9 (0.036) | 1.3 (0.052) | 4.6 (0.184) | 6.2 (0.248) | 4.6 (0.184) | 6.2 (0.248) | 5.9 (0.236) | 6.1 (0.244) | — | — | B7 |
| LR4-1300SSF | 61.5 (2.460) | 66.5 (2.660) | 9.4 (0.376) | 10.0 (0.400) | 0.9 (0.036) | 1.3 (0.052) | 5.0 (0.200) | 7.5 (0.300) | 5.0 (0.200) | 7.5 (0.300) | 5.9 (0.236) | 6.1 (0.244) | — | — | B8 |

Figures B13-B19 – Typical Time-to-Trip Curve at 20°C

VLR (data at 25°C)

- A = VLR170F
- B = VLR175F
- C = VLR230F

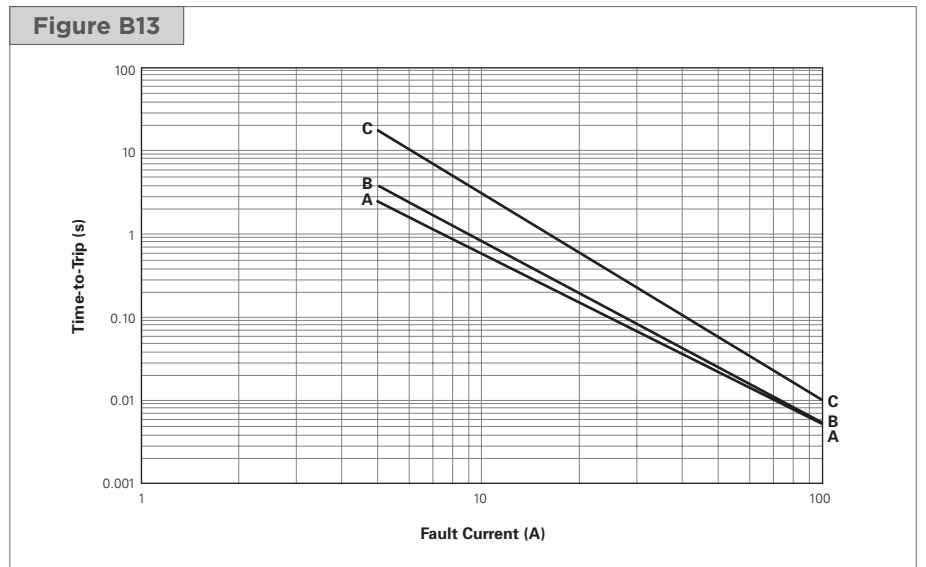

PolySwitch Resettable Devices

Strap Battery Devices

Figures B13-B19 – Typical Time-to-Trip Curve at 20°C

(Cont'd)

VLP (data at 25°C)

- A = VLP120UF
- B = VLP175UAF
- C = VLP210F
- D = VLP220F
- E = VLP270F

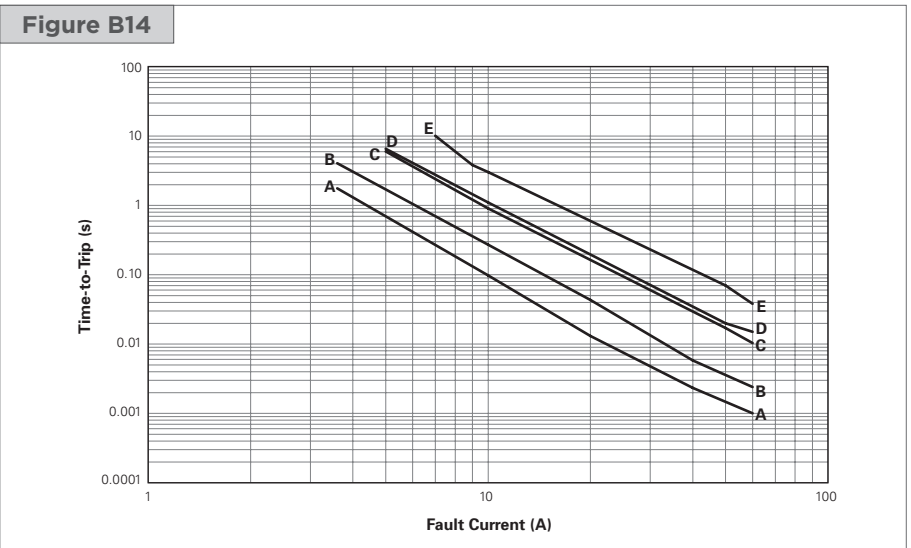

VTP (data at 25°C)

- A = VTP110F
- B = VTP170F
- C = VTP175F
- D = VTP210GF

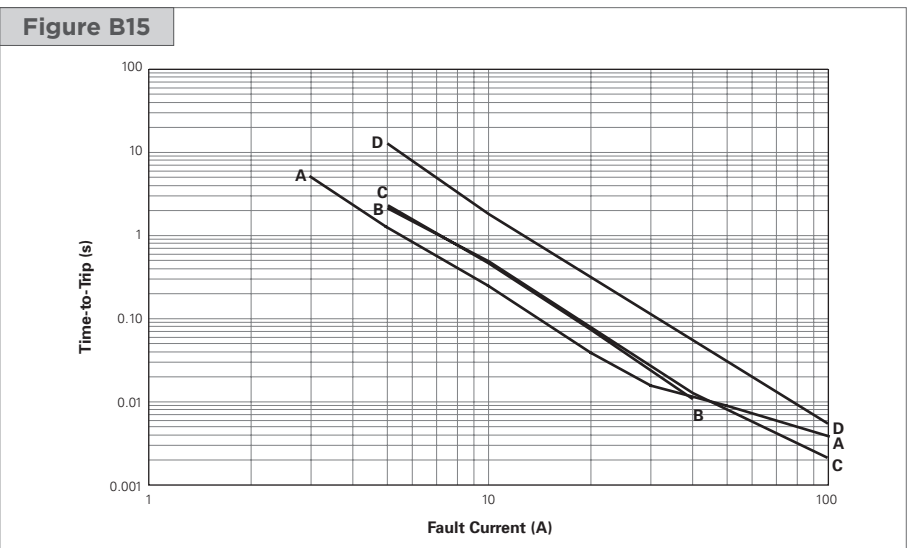

MXP (data at 25°C)

- A = MXP180
- B = MXP190BB
- C = MXP250K
- D = MXP270
- E = MXP310
- F = MXP370BD

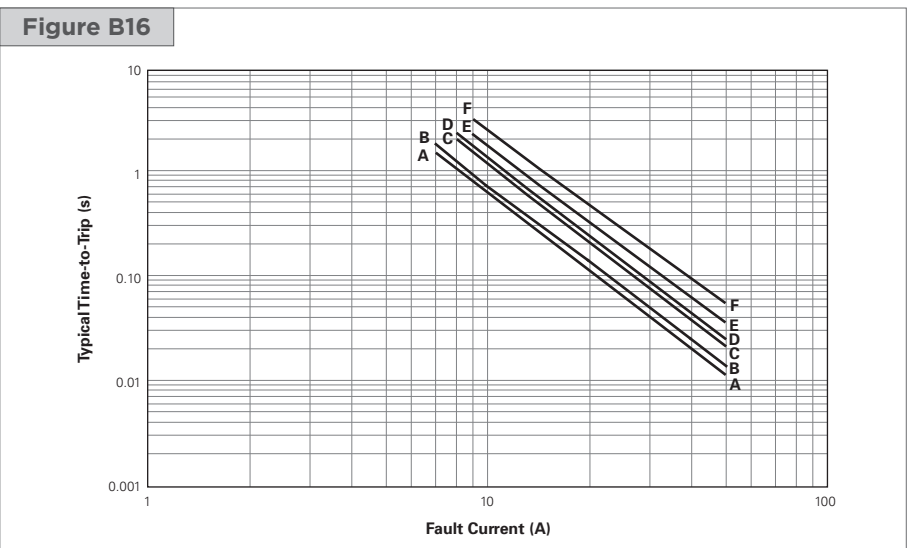

PolySwitch Resettable Devices

Strap Battery Devices

Figures B13-B19 – Typical Time-to-Trip Curve at 20°C

(Cont'd)

MGP

- A = MGP450
- B = MGP500

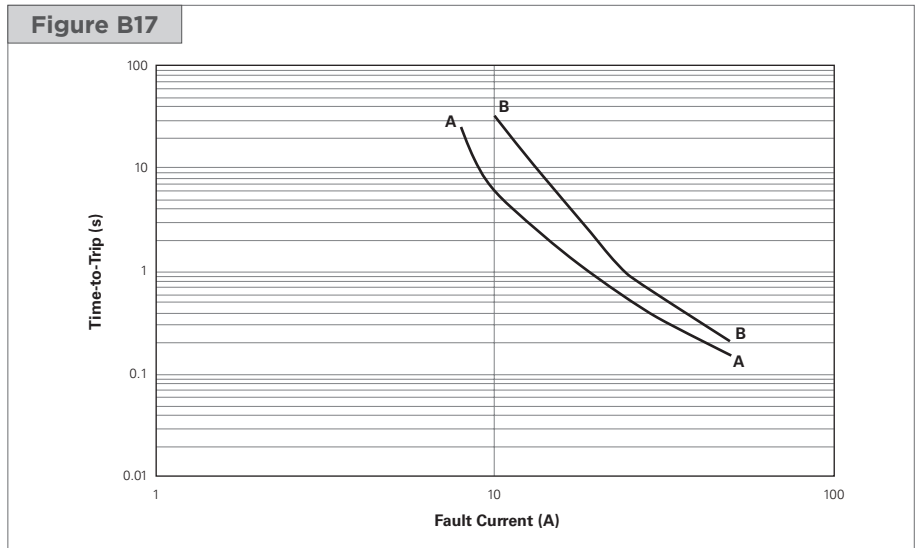

SRP

- A = SRP120F
- B = SRP175F
- C = SRP200F
- D = SRP350F
- E = SRP420F

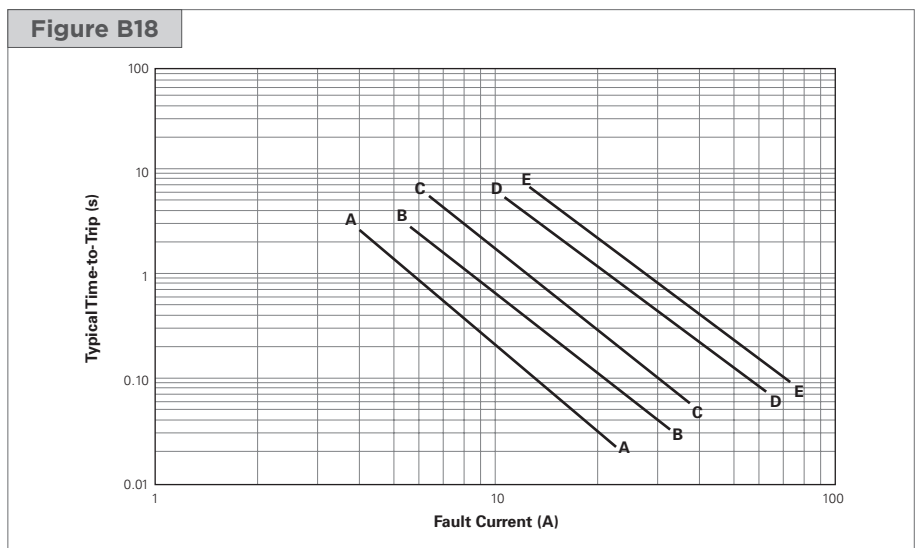

LR4

- A = LR4-190F
- B = LR4-260F
- C = LR4-380F
- D = LR4-450F
- E = LR4-550F
- F = LR4-600F
- G = LR4-730F
- H = LR4-900F
- I = LR4-1300SSF

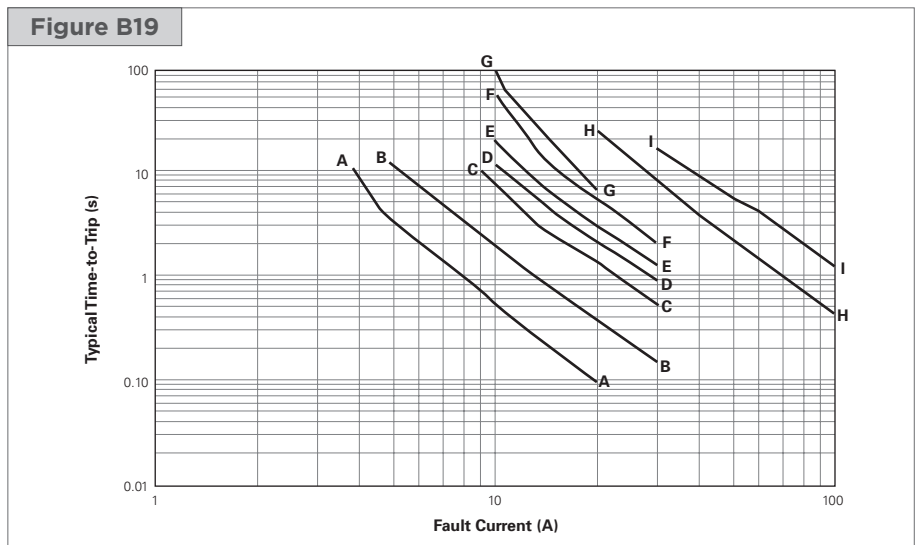

PolySwitch Resettable Devices

Strap Battery Devices

Table B5 – Physical Characteristics and Environmental Specifications

| VLR | | |
|------------------------------|--|-------------------|
| Physical Characteristics | | |
| Lead Material | 0.125mm Nominal Thickness, Quarter-hard Nickel | |
| Tape Material | Polyester | |
| Environmental Specifications | | |
| Test | Conditions | Resistance Change |
| Passive Aging | -40°C, 1000 hrs | ±5% typ |
| | 60°C, 1000 hrs | ±20% typ |
| Humidity Aging | 60°C/95% RH, 1000 hrs | ±30% typ |
| Thermal Shock | 85°C, -40°C (10 Times) | ±5% typ |
| Vibration | MIL-STD-883D, Method 2026 | No Change |
| VLP and VTP | | |
| Physical Characteristics | | |
| Lead Material | 0.125mm Nominal Thickness, Quarter-hard Nickel | |
| Tape Material | Polyester | |
| Environmental Specifications | | |
| Test | Conditions | Resistance Change |
| Passive Aging | -40°C, 1000 hrs | ±5% typ |
| | 60°C, 1000 hrs | ±10% typ |
| Humidity Aging | 60°C/95% RH, 1000 hrs | ±10% typ |
| Thermal Shock | 85°C, -40°C (10 Times) | ±5% typ |
| Vibration | MIL-STD-883D, Method 2026 | No Change |
| MXP and MGP | | |
| Physical Characteristics | | |
| Lead Material | 0.1mm Nominal Thickness, Half-hard Nickel | |
| Coating Material | Epoxy | |
| Environmental Specifications | | |
| Test | Conditions | Resistance Change |
| Passive Aging | -40°C, 1000 hrs | ±5% typ |
| | 60°C, 1000 hrs | ±20% typ |
| Humidity Aging | 60°C/95% RH, 1000 hrs | ±30% typ |
| Thermal Shock | 85°C, -40°C (10 Times) | ±5% typ |
| Vibration | MIL-STD-883D, Method 2026 | No Change |
| SRP | | |
| Physical Characteristics | | |
| Lead Material | 0.125mm Nominal Thickness, Quarter-hard Nickel | |
| Tape Material | Polyester | |
| Environmental Specifications | | |
| Test | Conditions | Resistance Change |
| Passive Aging | 70°C, 1000 hrs | ±10% typ |
| Humidity Aging | 85°C/85% RH, 7 Days | ±5% typ |
| Vibration | MIL-STD-883C, Test Condition A | No Change |

Note: Storage conditions: 40°C max., 70% RH max.; devices should remain in original sealed bags prior to use. Devices may not meet specified values if these storage conditions are exceeded.

PolySwitch Resettable Devices

Strap Battery Devices

Table B5 — Physical Characteristics and Environmental Specifications

(Cont'd)

| LR4 | | |
|------------------------------|--|-------------------|
| Physical Characteristics | | |
| Lead Material | 0.125mm Nominal Thickness, Quarter-hard Nickel | |
| Tape Material | Polyester | |
| Environmental Specifications | | |
| Test | Conditions | Resistance Change |
| Passive Aging | 70°C, 1000 hrs | ±10% typ |
| Humidity Aging | 85°C/85% RH, 7 Days | ±5% typ |
| Vibration | MIL-STD-883D, Method 2026 | No Change |

Note: Storage conditions: 40°C max., 70% RH max.; devices should remain in original sealed bags prior to use. Devices may not meet specified values if these storage conditions are exceeded.

Table B6 — Packaging and Marking Information/Agency Recognition

| Part Number | Bag Quantity | Tape and Reel Quantity | Standard Package Quantity | Part Marking | Agency Recognition |
|---------------------------------|--------------|------------------------|---------------------------|--------------|--------------------|
| 85°C Typical Activation | | | | | |
| VLR | | | | | |
| VLR170F | 1,000 | — | 10,000 | R17 | UL, CSA, TÜV |
| VLR175F | 1,000 | — | 10,000 | R1X | UL, CSA, TÜV |
| VLR175LF | 1,000 | — | 10,000 | R1X | UL, CSA, TÜV |
| VLR230F | 1,000 | — | 10,000 | R23 | UL, CSA, TÜV |
| 90°C Typical Activation | | | | | |
| VLP | | | | | |
| VLP120UF | 1,000 | — | 10,000 | — | UL, CSA, TÜV |
| VLP175UAF | 1,000 | — | 10,000 | — | UL, CSA, TÜV |
| VLP210F | 1,000 | — | 10,000 | W21 | UL, CSA, TÜV |
| VLP220F | 1,000 | — | 10,000 | W22 | UL, CSA, TÜV |
| VLP270F | 1,000 | — | 10,000 | W27 | UL, CSA, TÜV |
| VTP | | | | | |
| VTP110F | 1,000 | — | 10,000 | — | UL, CSA, TÜV |
| VTP170F | 1,000 | — | 10,000 | V17 | UL, CSA, TÜV |
| VTP170XSF | 1,000 | — | 10,000 | V17 | UL, CSA, TÜV |
| VTP175F | 1,000 | — | 10,000 | V1X | UL, CSA, TÜV |
| VTP175LF | 1,000 | — | 10,000 | V1X | UL, CSA, TÜV |
| VTP210GF | 1,000 | — | 10,000 | V21 | UL, CSA, TÜV |
| VTP210SF | 1,000 | — | 10,000 | V21 | UL, CSA, TÜV |
| 120°C Typical Activation | | | | | |
| MXP | | | | | |
| MXP180 | 2,000 | — | 48,000 | — | UL, CSA, TÜV |
| MXP190BB | 2,000 | — | 48,000 | — | UL, CSA, TÜV |
| MXP250K | 2,000 | — | 48,000 | — | UL, CSA, TÜV |
| MXP270 | 2,000 | — | 48,000 | — | UL |
| MXP310 | 2,000 | — | 48,000 | — | UL |
| MXP370BD | 2,000 | — | 48,000 | — | UL, CSA, TÜV |
| 120°C Typical Activation | | | | | |
| MGP | | | | | |
| MGP450 | 2,000 | — | 48,000 | — | — |
| MGP500 | 2,000 | — | 48,000 | — | UL, TÜV |

PolySwitch Resettable Devices

Strap Battery Devices

Table B6 — Packaging and Marking Information/Agency Recognition

(Cont'd)

| Part Number | Bag Quantity | Tape and Reel Quantity | Standard Package Quantity | Part Marking | Agency Recognition |
|-------------------------------------|--------------|------------------------|---------------------------|--------------|--------------------|
| 125°C Typical Activation SRP | | | | | |
| SRP120F | 1,000 | — | 10,000 | 120 | UL, CSA, TÜV |
| SRP175F | 2,000 | — | 10,000 | 175 | UL, CSA, TÜV |
| SRP200F | 1,000 | — | 10,000 | 200 | UL, CSA, TÜV |
| SRP350F | 500 | — | 10,000 | 350 | UL, CSA, TÜV |
| SRP420F | 500 | — | 10,000 | 420 | UL, CSA, TÜV |
| LR4 | | | | | |
| LR4-190F | 2,000 | — | 10,000 | E19 | UL, CSA, TÜV |
| LR4-260F | 1,000 | — | 10,000 | E26 | UL, CSA, TÜV |
| LR4-380F | 1,000 | — | 10,000 | E38 | UL, CSA, TÜV |
| LR4-380XF | 1,000 | — | 10,000 | E38 | UL, CSA, TÜV |
| LR4-450F | 1,000 | — | 10,000 | E45 | UL, CSA, TÜV |
| LR4-550F | 1,000 | — | 10,000 | E55 | UL, CSA, TÜV |
| LR4-600F | 1,000 | — | 10,000 | E60 | UL, CSA, TÜV |
| LR4-600XF | 1,000 | — | 10,000 | E60 | UL, CSA, TÜV |
| LR4-730F | 1,000 | — | 10,000 | E73 | UL, CSA, TÜV |
| LR4-900F | 500 | — | 10,000 | E90 | UL, CSA, TÜV |
| LR4-1300SSF | 250 | — | 10,000 | EX3 | UL, CSA, TÜV |

Agency Recognition

| | |
|-----|---|
| UL | File # E74889 |
| CSA | File # 78165C |
| TÜV | Certificate Number Available on Request |

Installation Guidelines for the Strap Family

- PPTC devices operate by thermal expansion of the conductive polymer. If devices are placed under pressure or installed in spaces that would prevent thermal expansion, they may not properly protect against damage caused by fault conditions. Designs must be selected in such a manner that adequate space is maintained over the life of the product.
- Twisting, bending, or placing the PPTC device in tension will decrease the ability of the device to protect against damage caused by electrical faults. No residual force should remain on device after installation. Mechanical damage to the PPTC device may affect device performance and should be avoided.
- Chemical contamination of PPTC devices should be avoided. Certain greases, solvents, hydraulic fluids, fuels, industrial cleaning agents, volatile components of adhesives, silicones, and electrolytes can have an adverse effect on device performance.
- PPTC strap devices are intended to be resistance welded to battery cells or to pack interconnect straps, yet some precautions must be taken when doing so. In order for the PPTC device to exhibit its specified performance, weld placement should be a minimum of 2mm from the edge of the PPTC device, weld splatter must not touch the PPTC device, and welding conditions must not heat the PPTC device above its maximum operating temperature.
- PPTC strap devices are not intended for applications where reflow onto flex circuits or rigid circuit boards is required.
- The polyester tape on PPTC strap devices is intended for marking and identification purposes only, not for electrical insulation.
- The coating on MXP and MGP devices is intended to prevent oxidization/aging of the devices. Damaging the coating or causing the coating to delaminate can have negative effects on device performance and should be avoided.
- MXP and MGP devices have a small PPTC chip size and therefore have weaker peel strength between the polymer and Ni-foil of the chip. Excessive mechanical force to the device may cause delamination of Ni-foil from the polymer.

PolySwitch Resettable Devices

Strap Battery Devices

Part Numbering System

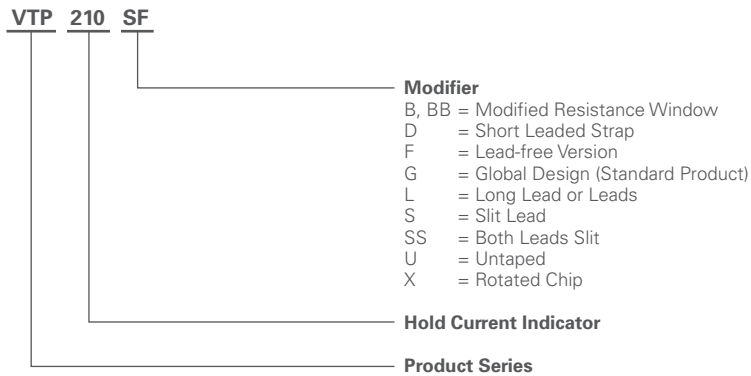

Warning :

- Users should independently evaluate the suitability of and test each product selected for their own application.
- Operation beyond the maximum ratings or improper use may result in device damage and possible electrical arcing and flame.
- These devices are intended for protection against damage caused by occasional overcurrent or overtemperature fault conditions and should not be used when repeated fault conditions or prolonged trip events are anticipated.
- Contamination of the PPTC material with certain silicone-based oils or some aggressive solvents can adversely impact the performance of the devices.
- Device performance can be impacted negatively if devices are handled in a manner inconsistent with recommended electronic, thermal, and mechanical procedures for electronic components.
- PPTC devices are not recommended for installation in applications where the device is constrained such that its PTC properties are inhibited, for example in rigid potting materials or in rigid housings, which lack adequate clearance to accommodate device expansion.
- Operation in circuits with a large inductance can generate a circuit voltage (Ldi/dt) above the rated voltage of the device.

Notice:

Information furnished is believed to be accurate and reliable. However, users should independently evaluate the suitability of and test each product selected for their own applications. Littelfuse products are not designed for, and shall not be used for, any purpose (including, without limitation, military, aerospace, medical, life-saving, life-sustaining or nuclear facility applications, devices intended for surgical implant into the body, or any other application in which the failure or lack of desired operation of the product may result in personal injury, death, or property damage) other than those expressly set forth in applicable Littelfuse product documentation. Warranties granted by Littelfuse shall be deemed void for products used for any purpose not expressly set forth in applicable Littelfuse documentation. Littelfuse shall not be liable for any claims or damages arising out of products used in applications not expressly intended by Littelfuse as set forth in applicable Littelfuse documentation. The sale and use of Littelfuse products is subject to Littelfuse Terms and Conditions of Sale, unless otherwise agreed by Littelfuse.

Компания «Океан Электроники» предлагает заключение долгосрочных отношений при поставках импортных электронных компонентов на взаимовыгодных условиях!

Наши преимущества:

- Поставка оригинальных импортных электронных компонентов напрямую с производств Америки, Европы и Азии, а так же с крупнейших складов мира;
- Широкая линейка поставок активных и пассивных импортных электронных компонентов (более 30 млн. наименований);
- Поставка сложных, дефицитных, либо снятых с производства позиций;
- Оперативные сроки поставки под заказ (от 5 рабочих дней);
- Экспресс доставка в любую точку России;
- Помощь Конструкторского Отдела и консультации квалифицированных инженеров;
- Техническая поддержка проекта, помощь в подборе аналогов, поставка прототипов;
- Поставка электронных компонентов под контролем ВП;
- Система менеджмента качества сертифицирована по Международному стандарту ISO 9001;
- При необходимости вся продукция военного и аэрокосмического назначения проходит испытания и сертификацию в лаборатории (по согласованию с заказчиком);
- Поставка специализированных компонентов военного и аэрокосмического уровня качества (Xilinx, Altera, Analog Devices, Intersil, Interpoint, Microsemi, Actel, Aeroflex, Peregrine, VPT, Syfer, Eurofarad, Texas Instruments, MS Kennedy, Miteq, Cobham, E2V, MA-COM, Hittite, Mini-Circuits, General Dynamics и др.);

Компания «Океан Электроники» является официальным дистрибьютором и эксклюзивным представителем в России одного из крупнейших производителей разъемов военного и аэрокосмического назначения «JONHON», а так же официальным дистрибьютором и эксклюзивным представителем в России производителя высокотехнологичных и надежных решений для передачи СВЧ сигналов «FORSTAR».



JONHON

«JONHON» (основан в 1970 г.)

Разъемы специального, военного и аэрокосмического назначения:

(Применяются в военной, авиационной, аэрокосмической, морской, железнодорожной, горно- и нефтедобывающей отраслях промышленности)

«FORSTAR» (основан в 1998 г.)

ВЧ соединители, коаксиальные кабели,
кабельные сборки и микроволновые компоненты:

(Применяются в телекоммуникациях гражданского и специального назначения, в средствах связи, РЛС, а так же военной, авиационной и аэрокосмической отраслях промышленности).



Телефон: 8 (812) 309-75-97 (многоканальный)

Факс: 8 (812) 320-03-32

Электронная почта: ocean@oceanchips.ru

Web: <http://oceanchips.ru/>

Адрес: 198099, г. Санкт-Петербург, ул. Калинина, д. 2, корп. 4, лит. А