

SPEC

Spec No.	TQ3C-8EAF0-E1DEZ91-00
Date	July 8, 2013

TYPE : TCG057QVLHA-G50
<5.7 inch QVGA transmissive color TFT
with LED backlight>

CONTENTS

1. Application
2. Construction and outline
3. Mechanical specifications
4. Absolute maximum ratings
5. Electrical characteristics
6. Optical characteristics
7. Interface signals
8. Input timing characteristics
9. Backlight characteristics
10. Lot number identification
11. Warranty
12. Precautions for use
13. Reliability test data
14. Outline drawing



KYOCERA DISPLAY CORPORATION

This specification is subject to change without notice.
Consult Kyocera before ordering.

Original Issue Date	Designed by: Engineering dept.			Confirmed by: QA dept.	
	Prepared	Checked	Approved	Checked	Approved
July 8, 2013	<i>K. Mori</i>	<i>Y. Yamazaki</i>	<i>M. Fujitani</i>	<i>O. Sato</i>	<i>T. Okamoto</i>

Spec No. TQ3C-8EAF0-E1DEZ91-00	Part No. TCG057QVLHA-G50	Page -
-----------------------------------	-----------------------------	-----------

Warning

1. This Kyocera LCD module has been specifically designed for use only in electronic devices and industrial machines in the area of audio control, office automation, industrial control, home appliances, etc. The module should not be used in applications where the highest level of safety and reliability are required and module failure or malfunction of such module results in physical harm or loss of life, as well as enormous damage or loss. Such fields of applications include, without limitation, medical, aerospace, communications infrastructure, atomic energy control. Kyocera expressly disclaims any and all liability resulting in any way to the use of the module in such applications.

2. Customer agrees to indemnify, defend and hold Kyocera harmless from and against any and all actions, claims, damages, liabilities, awards, costs, and expenses, including legal expenses, resulting from or arising out of Customer's use, or sale for use, or Kyocera modules in applications.

Caution

1. Kyocera shall have the right, which Customer hereby acknowledges, to immediately scrap or destroy tooling for Kyocera modules for which no Purchase Orders have been received from the Customer in a two-year period.

Spec No. TQ3C-8EAF0-E1DEZ91-00	Part No. TCG057QVLHA-G50	Page -
-----------------------------------	-----------------------------	-----------

Revision record

Date		Designed by : Engineering dept.			Confirmed by : QA dept.	
		Prepared	Checked	Approved	Checked	Approved
Rev.No.	Date	Page	Descriptions			

1. Application

This document defines the specification of TCG057QVLHA-G50. (RoHS Compliant)

2. Construction and outline

LCD	: Transmissive color dot matrix type TFT
Backlight system	: LED
Polarizer	: Glare treatment
Additional circuit	: Timing controller, Power supply (3.3V input) (without constant current circuit for LED Backlight)

3. Mechanical specifications

Item	Specification	Unit
Outline dimensions 1)	134.5(W) × 103.4(H) × 8(D)	mm
Active area	115.2(W) × 86.4(H) (14.4cm/5.7 inch(Diagonal))	mm
Dot format	320 × (B,G,R)(W) × 240(H)	dot
Dot pitch	0.12(W) × 0.36(H)	mm
Base color 2)	Normally White	-
Mass	(TBD)	g

1) Projection not included. Please refer to outline for details.

2) Due to the characteristics of the LCD material, the color varies with environmental temperature.

4. Absolute maximum ratings

4-1. Electrical absolute maximum ratings

Item	Symbol	Min.	Max.	Unit
Supply voltage	V _{DD}	0	4.0	V
Input signal voltage 1)	V _{IN}	-0.3	6.0	V
LED forward current 2)	I _F	-	100	mA

- 1) Input signal : CK, R0 ~ R5, G0 ~ G5, B0 ~ B5, H_{SYNC}, V_{SYNC}, ENAB, R/L, U/D
- 2) For each "AN-CA"
- 3) Do not apply reversed voltage.

4-2. Environmental absolute maximum ratings

Item	Symbol	Min.	Max.	Unit
Operating temperature 1)	T _{OP}	-20	70	°C
Storage temperature 2)	T _{STO}	-30	80	°C
Operating humidity 3)	H _{OP}	10	4)	%RH
Storage humidity 3)	H _{STO}	10	4)	%RH
Vibration	-	5)	5)	-
Shock	-	6)	6)	-

- 1) Operating temperature means a temperature which operation shall be guaranteed. Since display performance is evaluated at 25°C, another temperature range should be confirmed.
- 2) Temp. = -30°C < 48h , Temp. = 80°C < 168h
Store LCD at normal temperature/humidity. Keep them free from vibration and shock.
An LCD that is kept at a low or a high temperature for a long time can be defective due to other conditions, even if the low or high temperature satisfies the standard.
(Please refer to "Precautions for Use" for details.)
- 3) Non-condensing
- 4) Temp. 40°C, 85%RH Max.
Temp. > 40°C, Absolute humidity shall be less than 85%RH at 40°C.
- 5)

Frequency	10 ~ 55 Hz	Acceleration value (0.3 ~ 9 m/s ²)
Vibration width	0.15mm	
Interval	10-55-10 Hz	1 minutes

2 hours in each direction X, Y, Z (6 hours total)

EIAJ ED-2531

- 6) Acceleration: 490 m/s², Pulse width: 11 ms
3 times in each direction: ±X, ±Y, ±Z
EIAJ ED-2531

5. Electrical characteristics

Temp. = -20 ~ 70°C

Item	Symbol	Condition	Min.	Typ.	Max.	Unit
Supply voltage 1)	V _{DD}	-	3.0	3.3	3.6	V
Current consumption	I _{DD}	2)	-	80	105	mA
Permissive input ripple voltage	V _{RP}	-	-	-	100	mVp-p
Input signal voltage 3)	V _{IL}	"Low" level	0	-	0.3V _{DD}	V
	V _{IH}	"High" level	0.7V _{DD}	-	+5.5	V

1) V_{DD}-turn-on conditions

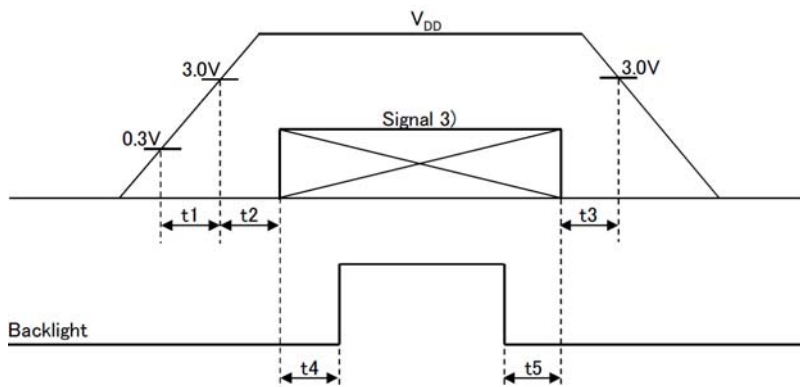

- 0 < t1 50ms
- 0 < t2 300ms
- 0 < t3 1s
- V_{SYNC} × 25pulse t4
- 0 t5

2) Display pattern:

V_{DD} = 3.3V, Temp. = 25

03456 ······ 95899999(dot)
 1
 2
 3
 :
 :
 :
 239
 240
 (dot)

3) Input signal : CK, R0 ~ R5, G0 ~ G5, B0 ~ B5, H_{SYNC}, V_{SYNC}, ENAB, R/L, U/D

6. Optical characteristics

Measuring spot = 6.0mm, Temp. = 25°C

Item	Symbol	Condition	Min.	Typ.	Max.	Unit	
Response time	Rise	τ_r	= =0°	-	10	-	ms
	Down	τ_d	= =0°	-	25	-	ms
Viewing angle range View direction : 12 o'clock (Gray inversion)	UPPER	CR 5	= =0°	-	80	-	deg.
	LOWER			-	80	-	
	LEFT			-	80	-	deg.
	ϕ RIGHT			-	80	-	
Contrast ratio	CR	= =0°	300	500	-	-	
Brightness	L	IF=60mA/Line	(700)	(1000)	-	cd/m ²	
Uniformity	LU	-	70	-	-	%	
Chromaticity coordinates	Red	x	= =0°	0.57	0.62	0.67	-
		y		0.32	0.37	0.42	
	Green	x	= =0°	0.29	0.34	0.39	
		y		0.55	0.60	0.65	
	Blue	x	= =0°	0.09	0.14	0.19	
		y		0.04	0.09	0.14	
	White	x	= =0°	0.27	0.32	0.37	
		y		0.29	0.34	0.39	

6-1. Definition of contrast ratio

$$CR(\text{Contrast ratio}) = \frac{\text{Brightness with all pixels "White"}}{\text{Brightness with all pixels "Black"}}$$

6-2. Definition of response time

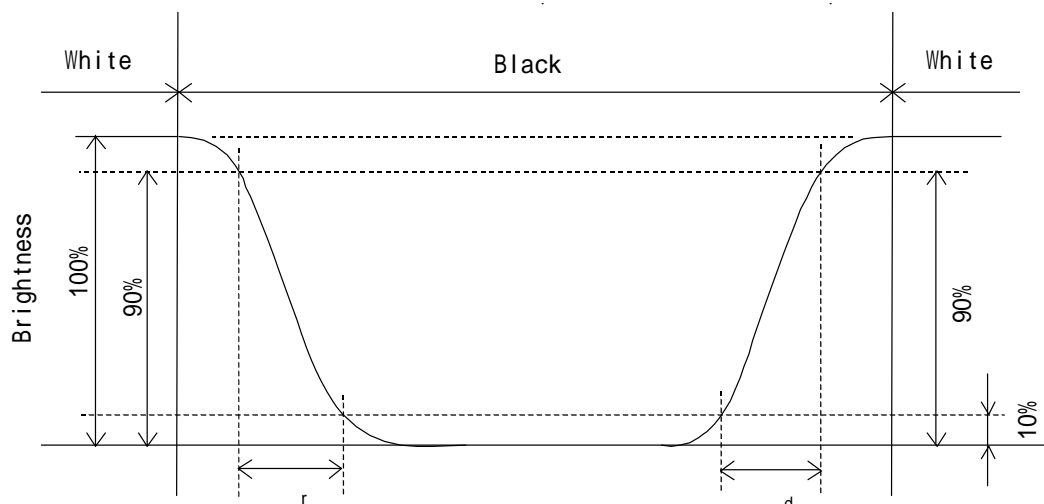

6-3. Definition of viewing angle

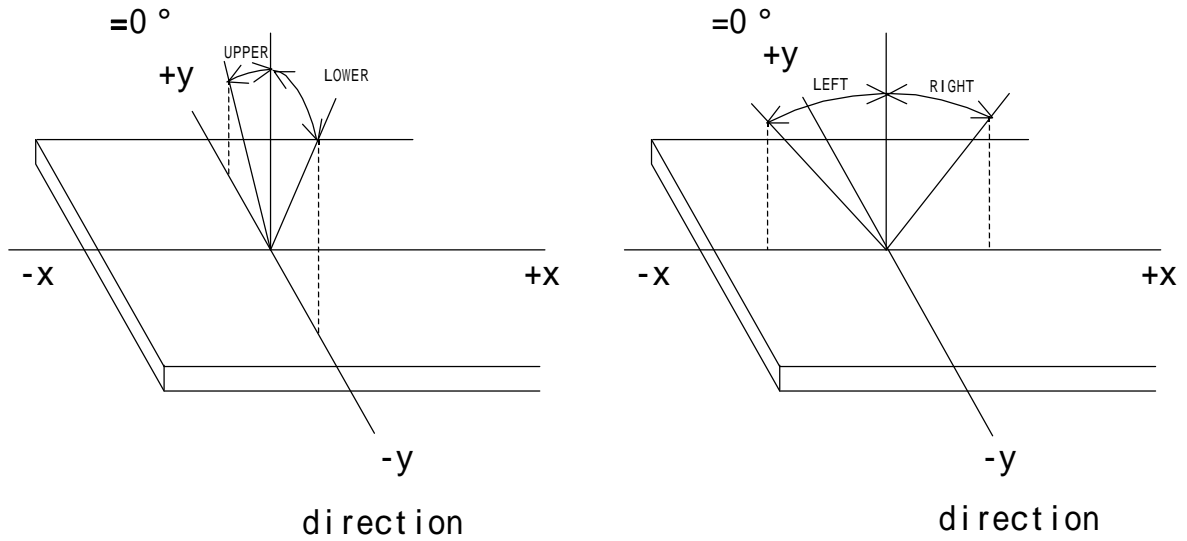

6-4. Brightness measuring points

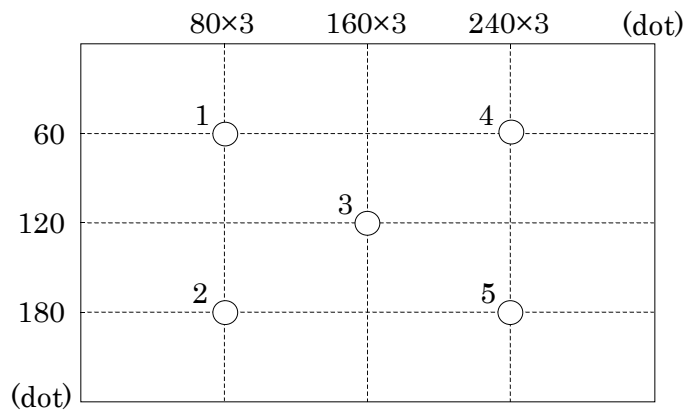

- 1) Rating is defined as the white brightness at center of display screen(3).
- 2) The brightness uniformity is calculated by using following formula.

$$\text{Brightness uniformity} = \frac{\text{Minimum brightness from 1 to 5}}{\text{Maximum brightness from 1 to 5}} \times 100 [\%]$$

- 3) 5 minutes after LED is turned on. (Ambient Temp.=25)

7. Interface signals

7-1. LCD

No.	Symbol	Description	I/O	Note
1	GND	GND	-	
2	CK	Clock signal for sampling each data signal	I	
3	H _{SYNC}	Horizontal synchronous signal (negative)	I	
4	V _{SYNC}	Vertical synchronous signal (negative)	I	
5	GND	GND	-	
6	R0	RED data signal (LSB)	I	
7	R1	RED data signal	I	
8	R2	RED data signal	I	
9	R3	RED data signal	I	
10	R4	RED data signal	I	
11	R5	RED data signal (MSB)	I	
12	GND	GND	-	
13	G0	GREEN data signal (LSB)	I	
14	G1	GREEN data signal	I	
15	G2	GREEN data signal	I	
16	G3	GREEN data signal	I	
17	G4	GREEN data signal	I	
18	G5	GREEN data signal (MSB)	I	
19	GND	GND	-	
20	B0	BLUE data signal (LSB)	I	
21	B1	BLUE data signal	I	
22	B2	BLUE data signal	I	
23	B3	BLUE data signal	I	
24	B4	BLUE data signal	I	
25	B5	BLUE data signal (MSB)	I	
26	GND	GND	-	
27	ENAB	Signal to settle the horizontal display position (positive)	I	1)
28	V _{DD}	3.3V power supply	-	
29	V _{DD}	3.3V power supply	-	
30	R/L	Horizontal display mode select signal L : Normal , H : Left / Right reverse mode	I	2)
31	U/D	Vertical display mode select signal H : Normal , L : Up / Down reverse mode	I	2)
32	NC	No connect	I	
33	GND	GND	-	

LCD connector : IMSA-9681S-33A-GF (IRISO)
Recommended matching FFC or FPC : 0.5mm pitch

- 1) The horizontal display start timing is settled in accordance with a rising timing of ENAB signal.
In case ENAB is fixed "Low", the horizontal start timing is determined.
Don't keep ENAB "High" during operation.

2)



R/L = L
U/D = H



R/L = H
U/D = H



R/L = L
U/D = L



R/L = H
U/D = L

7-2 . LED

No.	Symbol	Description
1	AN1	Anode 1
2	AN2	Anode 2
3	CA1	Cathode 1
4	CA2	Cathode 2

LCD side connector : PHR-4

(JST)

Recommended matching connector

: B4B-PH-SM4-TB

(JST)

: B4B-PH-SM4-TB(LF)(SN)

(JST)···(RoHS Compliant)

: S4B-PH-SM4-TB

(JST)

: S4B-PH-SM4-TB(LF)(SN)

(JST)···(RoHS Compliant)

8. Input timing characteristics

8-1. Timing characteristics

Item		Symbol	Min	Typ	Max	Unit	Note
Clock	Frequency	1/Tc	-	6.3	7.0	MHz	
	Duty ratio	Tch/Tc	40	50	60	%	
Data	Set up time	Tds	5	-	-	ns	
	Hold time	Tdh	10	-	-	ns	
Horizontal sync. signal	Cycle	TH	50.0	63.6	-	μs	
			360	400	450	clock	
	Pulse width	THp	2	96	200	clock	
Vertical sync. signal	Cycle	TV	251	262	280	line	
	Pulse width	TVp	2	-	34	line	
Horizontal display period		THd	320			clock	
Hsync,-Clock phase difference		THc	10	-	Tc-10	ns	
Hsync-Vsync. phase difference		TVh	Tc	-	TH-THp	ns	
Vertical sync. signal start position		TVs	7			line	
Vertical display period		TVd	240			line	

- 1) In case of lower frequency, the deterioration of the display quality, flicker etc., may occur.

8-2. Horizontal display position

Item		Symbol	Min	Typ	Max	Unit	Note
Enable signal	Set up time	Tes	5	-	Tc-10	ns	
	Pulse width	Tep	2	320	TH-10	clock	
H _{SYNC} – Enable signal phase difference		The	2	-	TH-340	clock	

- 1) When ENAB is fixed at "Low", the display starts from the data of C52(clock) as shown in 8-5.
- 2) The horizontal display position is determined by ENAB signal.

8-3. Vertical display position

- 1) The vertical display position (TVs) is 7th line.
- 2) ENAB signal is independent of vertical display position.

8-4. Input Data Signals and Display position on the screen

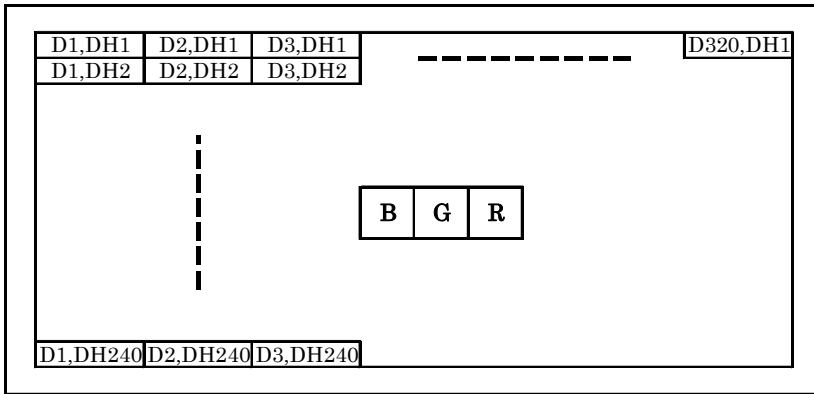

8-5. Input timing characteristics

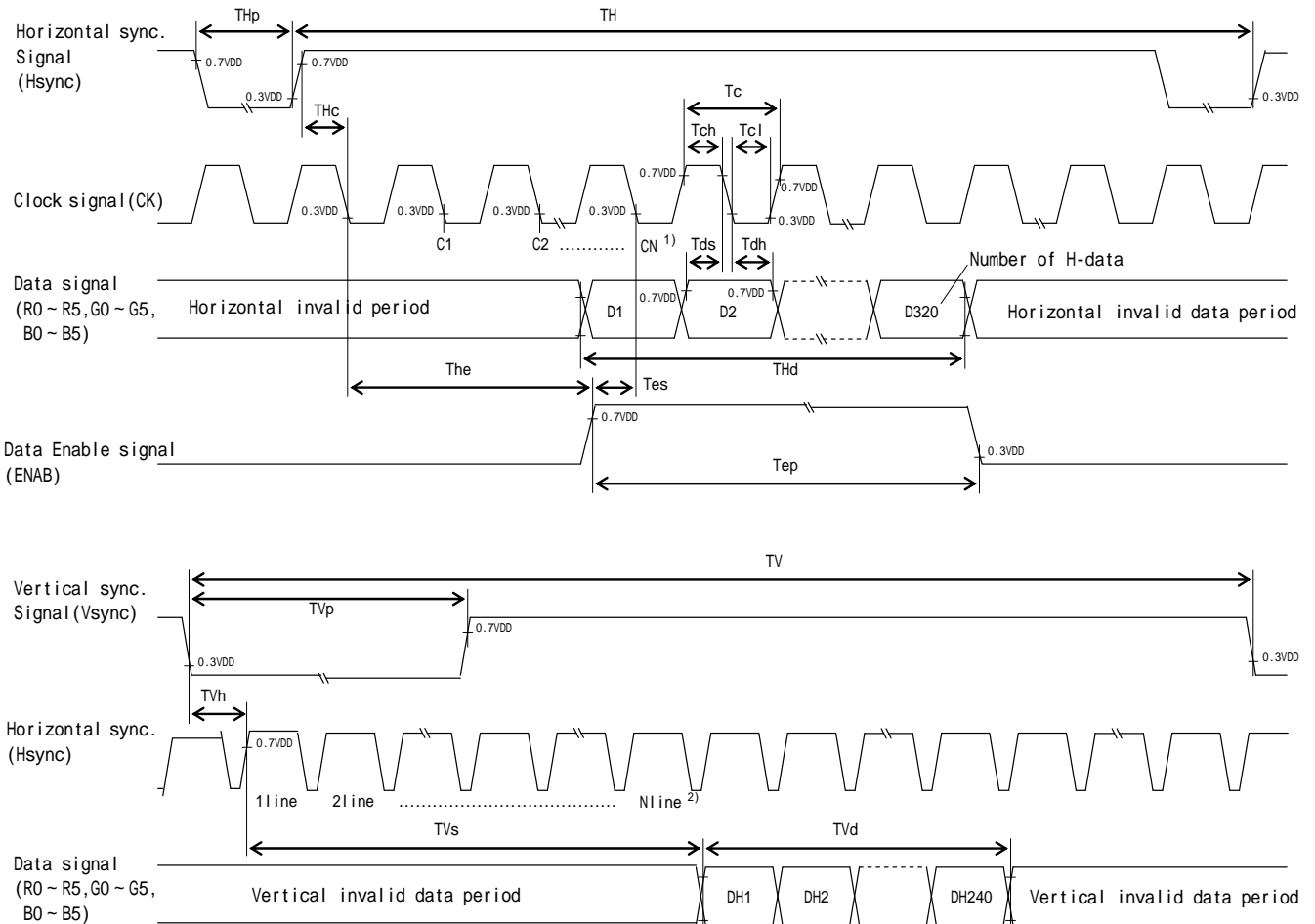

- 1) When ENAB is fixed at "Low", the display starts from the data of C52(Clock).
- 2) The vertical display position(TVs) is fixed at 7th line.

9. Backlight characteristics

Item	Symbol	Min.	Typ.	Max.	Unit	Note
Forward current 1)	IF	-	60	-	mA	Ta=-20 ~ 70°C
Forward voltage 1)	VF	-	18.9	22.1	V	IF=60mA, Ta=-20
		-	18.0	21.2	V	IF=60mA, Ta=25
		-	17.5	20.6	V	IF=60mA, Ta=70
Operating life time 2), 3)	T	-	(50,000)	-	h	IF=60mA, Ta=25

1) For each "AN-CA"

2) When brightness decrease 50% of minimum brightness.

The average life of a LED will decrease when the LCD is operating at higher temperatures.

3) Life time is estimated data.(Condition : IF=60mA, Ta=25 in chamber).

4) An input current below 15mA may reduce the brightness uniformity of the LED backlight.

This is because the amount of light from each LED chip is different. Therefore, please evaluate carefully before finalizing the input current.

10. Lot number identification

The lot number shall be indicated on the back of the backlight case of each LCD.

TCG057QVLHA-G50 - □□ - □□ - □ MADE IN □□□□□
 ↓ ↓ ↓ ↓ ↓
 1 2 3 4 5

No1. - No5. above indicate
 1. Year code
 2. Month code
 3. Date
 4. Version Number
 5. Country of origin (Japan or China)

Year	2013	2014	2015	2016	2017	2018
Code	3	4	5	6	7	8

Month	Jan.	Feb.	Mar.	Apr.	May	Jun.
Code	1	2	3	4	5	6

Month	Jul.	Aug.	Sep.	Oct.	Nov.	Dec.
Code	7	8	9	X	Y	Z

11. Warranty

11-1. Incoming inspection

Please inspect the LCD within one month after your receipt.

11-2. Production warranty

Kyocera warrants its LCD's for a period of 12 months from the ship date. Kyocera shall, by mutual agreement, replace or re-work defective LCD's that are shown to be Kyocera's responsibility.

Spec No. TQ3C-8EAF0-E1DEZ91-00	Part No. TCG057QVLHA-G50	Page 12
-----------------------------------	-----------------------------	------------

12. Precautions for use

12-1. Installation of the LCD

- 1) A transparent protection plate shall be added to protect the LCD and its polarizer
- 2) The LCD shall be installed so that there is no pressure on the LSI chips.
- 3) The LCD shall be installed flat, without twisting or bending.
- 4) A transparent protection sheet is attached to the polarizer. Please remove the protection film slowly before use, paying attention to static electricity.

12-2. Static electricity

- 1) Since CMOS ICs are mounted directly onto the LCD glass, protection from static electricity is required.
- 2) Workers should use body grounding. Operator should wear ground straps.

12-3. LCD operation

- 1) The LCD shall be operated within the limits specified. Operation at values outside of these limits may shorten life, and/or harm display images.

12-4. Storage

- 1) The LCD shall be stored within the temperature and humidity limits specified.
Store in a dark area, and protect the LCD from direct sunlight or fluorescent light.
- 2) Always store the LCD so that it is free from external pressure onto it.

12-5. Usage

- 1) **DO NOT** store in a high humidity environment for extended periods. Polarizer degradation bubbles, and/or peeling off of the polarizer may result.
- 2) The front polarizer is easily scratched or damaged. Prevent touching it with any hard material, and from being pushed or rubbed.
- 3) The LCD screen may be cleaned by wiping the screen surface with a soft cloth or cotton pad using a little Ethanol.
- 4) Water may cause damage or discoloration of the polarizer. Clean condensation or moisture from any source immediately.
- 5) Always keep the LCD free from condensation during testing. Condensation may permanently spot or stain the polarizer.
- 6) Do not pull the LED lead wires and do not bend the root of the wires. Housing should be designed to protect LED lead wires from external stress.
- 7) Do not disassemble LCD because it will result in damage.
- 8) This Kyocera LCD has been specifically designed for use in general electronic devices, but not for use in a special environment such as usage in an active gas. Hence, when the LCD is supposed to be used in a special environment, evaluate the LCD thoroughly beforehand and do not expose the LCD to chemicals such as an active gas.
- 9) Please do not use solid-base image pattern for long hours because a temporary afterimage may appear. We recommend using screen saver etc. in cases where a solid-base image pattern must be used.
- 10) Liquid crystal may leak when the LCD is broken. Be careful not to let the fluid go into your eyes and mouth. In the case the fluid touches your body; rinse it off right away with water and soap.

13. Reliability test data

Test item	Test condition	Test time	Judgement
High temp. atmosphere	80°C	240h	Display function : No defect Display quality : No defect Current consumption : No defect
Low temp. atmosphere	-30°C	240h	Display function : No defect Display quality : No defect Current consumption : No defect
High temp. humidity atmosphere	40°C 90% RH	240h	Display function : No defect Display quality : No defect Current consumption : No defect
Temp. cycle	-30°C 0.5h R.T. 0.5h 80°C 0.5h	10cycles	Display function : No defect Display quality : No defect Current consumption : No defect
High temp. operation	70°C	500h	Display function : No defect Display quality : No defect Current consumption : No defect

- 1) Each test item uses a test LCD only once. The tested LCD is not used in any other tests.
- 2) The LCD is tested in circumstances in which there is no condensation.
- 3) The reliability test is not an out-going inspection.
- 4) The result of the reliability test is for your reference purpose only.
The reliability test is conducted only to examine the LCD's capability.

No	Description	Drawn	Checked	Checked	Approved

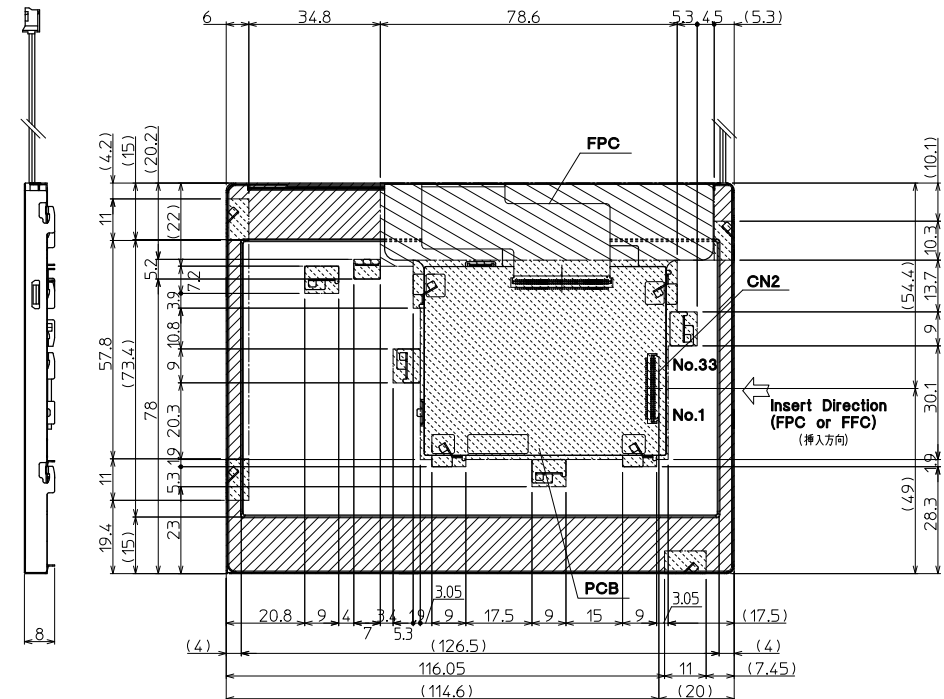
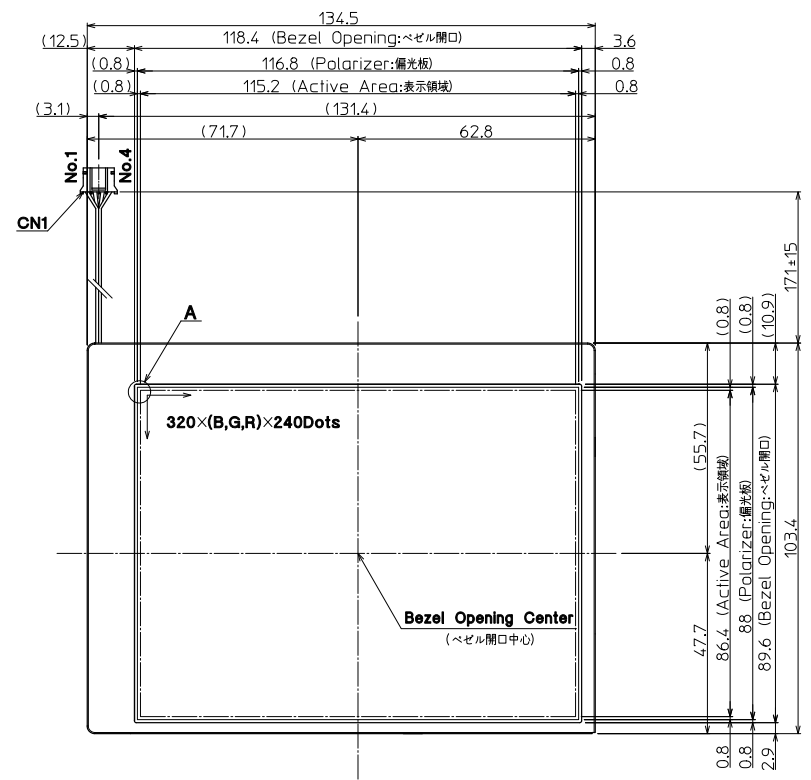

- : Projected part is 5.5mm thickness. (厚み 5.5mm)
- : Projected part is 8mm thickness. (厚み 8mm)
- : Projected part is 6mm thickness. (厚み 6mm)
- : Projected part is (7.5)mm thickness. (厚み (7.5)mm)



DETAIL A (Dot Size)
(NTS)

CN1 Pin Assign

No.	Cable Color
No.1	Black(黒)
No.2	Red(赤)
No.3	White(白)
No.4	Blue(青)

- Note. (注記)
- Connector CN1: PHR-4 (JST)
(コネクタ) CN2: IMSA-9681S-33A-GF (IRISO)
2. Matching Connector: B4B-PH-SM4-TB (JST)
(適合コネクタ) B4B-PH-SM4-TB(LF)(SN) (JST)
S4B-PH-SM4-TB (JST)
S4B-PH-SM4-TB(LF)(SN) (JST) etc.
 - The Information of LCD is displayed starting at the upper left hand corner, moving right then down to the lower right hand corner.
(LCDにおいて、画像データの表示は左上コーナーから始まり、右へ進み下へ送られ右下コーナーへ向かう。)
 - Tolerance without indication: ±0.5
(指示無き公差)

Material 材質	Treatment 処理	Approved '10.11.04	Checked	Checked '10.11.04	Drawn 圓福	Scale 1:1 (NTS)	Title TCG057QVLHA	Year-Month-Day '10.11.04	Size 2
Quantity 製作数	Description 備考	徳森		今村			Outline Dimensions	Drawing No. 121A8037300	

参考(for Reference)

IRISO 製 9681 シリーズコネクタの取り扱い上の注意

Precautions when using IRISO.9681 series connector

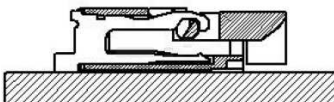
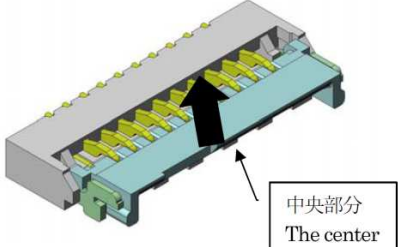
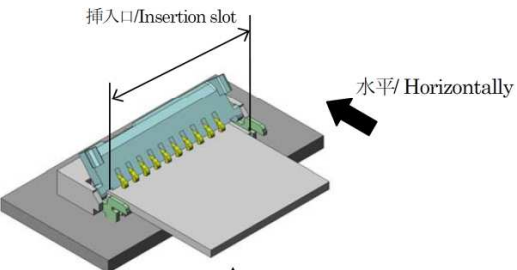
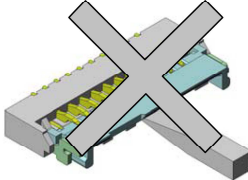
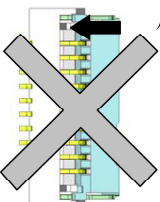
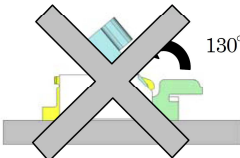
操作方法	使用上の注意点
<p>FPC/FFC挿入方法 FPC/FFC insertion</p> <p>①カバー先端を上方向に上げて開けて下さい。(カバーは回転動作をします)</p> <p>① pull up the cover tip to open up. (the cover will rotate to operate)</p> <p>カバーの先端部分を親指や人差し指の爪により、矢印方向に跳ね上げる感じでロック解除を行って下さい。破損の原因となりますので、水平方向には押さないで下さい。</p> <p>To release the lock, flip the lock to a direction of arrow with the nail of pointer or thumb.</p> <p>Please Don't push the cover horizontally; it causes damage.</p>  <p>補足 addition</p> <p>カバー中央部分を上方へ跳ね上げてロック解除を行って下さい。Flip the center part of cover to release the lock.</p>  <p>②FPC/FFC の導体面を下にして挿入して下さい。</p> <p>②Make the conductor side of FPC/FFC below, and insert it.</p> <p>挿入口/Insertion slot</p> <p>水平/ Horizontally</p>  <p>導体面(下) Conductor side(bottom)</p> <p>補足 addition</p> <p>FPC/FFC の挿入は、カバーを 130° 開いた状態で、挿入口に対して水平になる様、挿入して下さい。カバーが倒れない様、手で軽く支えますとより挿入し易くなります。</p> <p>To insert a FPC/FFC, open the cover in 130° , and insert the FPC/FFC horizontally to an insertion slot.</p> <p>Supporting the cover lightly by hand will be the way to insert easily.</p>	<p>9681 シリーズは、小型・薄型である為、強度は強くありませんので、取り扱いには十分注意して下さい。</p> <p>Please handle with fragile care.</p> <p>9681series are small and thin, so the strength are little short.</p> <p>作業の際は、手袋及びアースバンドを着用して下さい。</p> <p>Please wear gloves and a ground belt when the time of the work.</p> <p>ロック解除の際に、ドライバー等先端が細く硬い工具を使用時の操作は行わないで下さい。変形・破損する事があります。</p> <p>In case of releasing the lock, please don't use hard tools with thin tip, like a driver. It can be deformed and damaged.</p>  <p>ロック解除時、カバー片端 (左 or 右) のみに力を加えてロック解除を行わないで下さい。変形・破損する事があります。</p> <p>In case of releasing the lock, please don't make a force on the one edge of cover. It can be deformed and damaged.</p>  <p>片端のみ/only one edge</p> <p>カバーは 130° 以上開かない構造の為、更に後ろへ強い力を加えないで下さい。変形・破損する事があります。</p> <p>The cover is structured not to open more than 130° , so please don't add a strong force backward. It can be deformed and damaged.</p>  <p>130°</p> <p>FPC/FFC は、挿入口に正しく挿入して下さい。斜め挿入等、正しく挿入されていない場合は、導通不良の原因となります。</p> <p>Please insert FPC/FFC in insertion slot properly. If it's not inserted properly, like leaned insertion, it will cause a bad connection.</p> <p>FPC/FFC は、弊社推奨サイズを使用して下さい。弊社推奨サイズ以外を使用した場合は品質保証出来ません。</p> <p>Please use our preferred size of FPC/FFC. We can not certify the quality except using our recommended size of FPC/FFC.</p>

イリソ電子工業株式会社作成の資料より引用

Refer to the data made by IRISO ELECTRONICS CO., LTD.

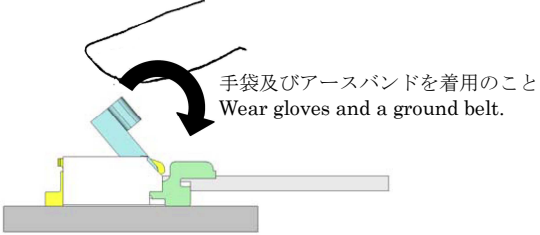
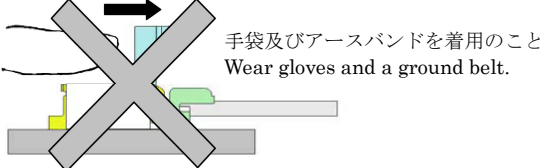
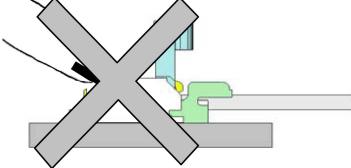
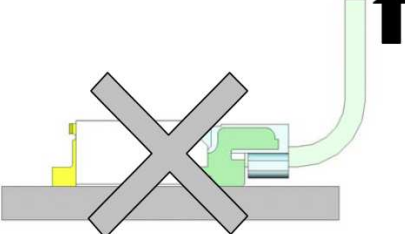
操作方法	使用上の注意点
<p>FPCのロック方法 The method to lock the FPC</p> <p>①カバーを回転させてロックして下さい。 ①Turn down the cover to lock it.</p>  <p>補足/addition ロック後、カバー両端を軽く押すと、カバーの半ロックを防止できます。 After locking, to push the both edge of cover with light force can prevent a half lock 開閉作業の際は、コンタクトに触れないで下さい。変形による接触不良の原因となります。 Please don't touch the contact while opening and shutting the cover. It causes bad connection by deformed contact.</p>	<p>ロック操作の際に下図の矢印方向に強い力を加えてカバーを押さないで下さい。変形・破損の原因となります。 In case of lock operation, please don't push the cover strongly to the direction of arrow. It causes deformation and damage.</p> <p>水平方向に押す /Pushing in a horizontal direction</p>  <p>根元を押す /Pushing the base</p>  <p>その他/ Others コネクタの構造上、上方向への引張強度は強くありませんので、上方向へ強い力を加えないで下さい。使用上、FPC/FFC に引張力が加わる場合は、上方向の力がコネクタに加わらない様、FPC/FFC をテープ等で固定して下さい。 As a structure of connector, the strength to upper direction is little short. So please don't make a force in above direction. In case of necessary to draw a FPC/FFC out, Please fix the FPC/FFC with a tape to protect the connector from an upper force.</p>  <p>カバーをロックした状態で、FPC/FFC に引張力を加えないで下さい。FPC/FFC 導体面の削れ、及び半挿入状態による導通不良の原因となります。 Please don't draw the FPC/FFC out while the cover is locked. It causes scraping the conductor surface and bad connection by half insertion.</p>

Spec No.	TQ3C-8EAF0-E2DEZ91-00
Date	July 8, 2013

KYOCERA INSPECTION STANDARD

TYPE : TCG057QVLHA-G50

KYOCERA DISPLAY CORPORATION

Original Issue Date	Designed by : Engineering dept.			Confirmed by : QA dept.	
	Prepared	Checked	Approved	Checked	Approved
July 8, 2013	<i>H. Mori</i>	<i>Y. Yamazaki</i>	<i>M. Fujitani</i>	<i>O. Sato</i>	<i>T. Okamoto</i>

Spec No. TQ3C-8EAF0-E2DEZ91-00	Part No. TCG057QVLHA-G50	Page -
-----------------------------------	-----------------------------	-----------

Revision record

Date		Designed by : Engineering dept.			Confirmed by : QA dept.	
		Prepared	Checked	Approved	Checked	Approved
Rev.No.	Date	Page	Descriptions			

Visuals specification

1) Note

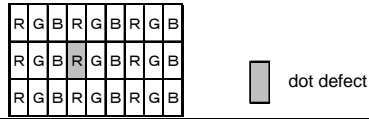
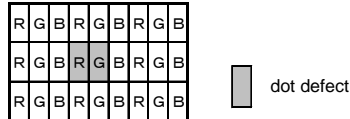
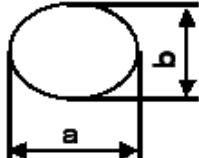
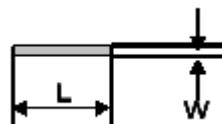
		Note
General		<p>1. Customer identified anomalies not defined within this inspection standard shall be reviewed by Kyocera, and an additional standard shall be determined by mutual consent.</p> <p>2. This inspection standard about the image quality shall be applied to any defect within the active area and shall not be applicable to outside of the area.</p> <p>3. Inspection conditions</p> <p>Luminance : 500 Lux min.</p> <p>Inspection distance : 300 mm.</p> <p>Temperature : 25 ± 5</p> <p>Direction : Directly above</p>
Definition of inspection item	Dot defect	<p>Bright dot defect</p> <p>The dot is constantly “on” when power applied to the LCD, even when all “Black” data sent to the screen. Inspection tool: 5% Transparency neutral density filter. Count dot: If the dot is visible through the filter. Don't count dot: If the dot is not visible through the filter.</p> 
		<p>Black dot defect</p> <p>The dot is constantly “off” when power applied to the LCD, even when all “White” data sent to the screen.</p>
		<p>Adjacent dot</p> <p>Adjacent dot defect is defined as two or more bright dot defects or black dot defects.</p> 
	External inspection	<p>Bubble, Scratch, Foreign particle (Polarizer, Cell, Backlight)</p> <p>Visible operating (all pixels “Black” or “White”) and non operating.</p>
		<p>Appearance inspection</p> <p>Does not satisfy the value at the spec.</p>
	Others	<p>LED wires</p> <p>Damaged to the LED wires, connector, pin, functional failure or appearance failure.</p>
	Definition of size	<p>Definition of circle size</p>  <p>$d = (a + b) / 2$</p> <p>Definition of linear size</p> 

2) Standard

Classification		Inspection item	Judgement standard																										
Defect (in LCD glass)	Dot defect	Bright dot defect	Acceptable number : 4 Bright dot spacing : 5 mm or more																										
		Black dot defect	Acceptable number : 5 Black dot spacing : 5 mm or more																										
		2 dot join	Bright dot defect	Acceptable number : 2																									
			Black dot defect	Acceptable number : 3																									
		3 or more dots join	Acceptable number : 0																										
		Total dot defects	Acceptable number : 5 Max																										
	Others	White dot, Dark dot (Circle)	<table border="1"> <thead> <tr> <th colspan="2">Size (mm)</th> <th>Acceptable number</th> </tr> </thead> <tbody> <tr> <td>d</td> <td>0.2</td> <td>(Neglected)</td> </tr> <tr> <td>0.2 < d</td> <td>0.4</td> <td>5</td> </tr> <tr> <td>0.4 < d</td> <td>0.5</td> <td>3</td> </tr> <tr> <td>0.5 < d</td> <td></td> <td>0</td> </tr> </tbody> </table>			Size (mm)		Acceptable number	d	0.2	(Neglected)	0.2 < d	0.4	5	0.4 < d	0.5	3	0.5 < d		0									
Size (mm)		Acceptable number																											
d	0.2	(Neglected)																											
0.2 < d	0.4	5																											
0.4 < d	0.5	3																											
0.5 < d		0																											
External inspection (Defect on Polarizer or between Polarizer and LCD glass)	Polarizer (Scratch)	<table border="1"> <thead> <tr> <th colspan="2">Width (mm)</th> <th colspan="2">Length (mm)</th> <th>Acceptable number</th> </tr> </thead> <tbody> <tr> <td>W</td> <td>0.1</td> <td colspan="2">-</td> <td>(Neglected)</td> </tr> <tr> <td rowspan="2">0.1 < W</td> <td rowspan="2">0.3</td> <td colspan="2">L 5.0</td> <td>(Neglected)</td> </tr> <tr> <td colspan="2">5.0 < L</td> <td>0</td> </tr> <tr> <td colspan="2">0.3 < W</td> <td colspan="2">-</td> <td>0</td> </tr> </tbody> </table>			Width (mm)		Length (mm)		Acceptable number	W	0.1	-		(Neglected)	0.1 < W	0.3	L 5.0		(Neglected)	5.0 < L		0	0.3 < W		-		0		
		Width (mm)		Length (mm)		Acceptable number																							
		W	0.1	-		(Neglected)																							
		0.1 < W	0.3	L 5.0		(Neglected)																							
	5.0 < L			0																									
	0.3 < W		-		0																								
	Polarizer (Bubble)	<table border="1"> <thead> <tr> <th colspan="2">Size (mm)</th> <th>Acceptable number</th> </tr> </thead> <tbody> <tr> <td>d</td> <td>0.2</td> <td>(Neglected)</td> </tr> <tr> <td>0.2 < d</td> <td>0.3</td> <td>5</td> </tr> <tr> <td>0.3 < d</td> <td>0.5</td> <td>3</td> </tr> <tr> <td>0.5 < d</td> <td></td> <td>0</td> </tr> </tbody> </table>			Size (mm)		Acceptable number	d	0.2	(Neglected)	0.2 < d	0.3	5	0.3 < d	0.5	3	0.5 < d		0										
		Size (mm)		Acceptable number																									
		d	0.2	(Neglected)																									
		0.2 < d	0.3	5																									
	0.3 < d	0.5	3																										
	0.5 < d		0																										
Foreign particle (Circular shape)	<table border="1"> <thead> <tr> <th colspan="2">Size (mm)</th> <th>Acceptable number</th> </tr> </thead> <tbody> <tr> <td>d</td> <td>0.2</td> <td>(Neglected)</td> </tr> <tr> <td>0.2 < d</td> <td>0.4</td> <td>5</td> </tr> <tr> <td>0.4 < d</td> <td>0.5</td> <td>3</td> </tr> <tr> <td>0.5 < d</td> <td></td> <td>0</td> </tr> </tbody> </table>			Size (mm)		Acceptable number	d	0.2	(Neglected)	0.2 < d	0.4	5	0.4 < d	0.5	3	0.5 < d		0											
	Size (mm)		Acceptable number																										
	d	0.2	(Neglected)																										
	0.2 < d	0.4	5																										
0.4 < d	0.5	3																											
0.5 < d		0																											
Foreign particle (Linear shape) Scratch	<table border="1"> <thead> <tr> <th colspan="2">Width (mm)</th> <th colspan="2">Length (mm)</th> <th>Acceptable number</th> </tr> </thead> <tbody> <tr> <td>W</td> <td>0.03</td> <td colspan="2">-</td> <td>(Neglected)</td> </tr> <tr> <td rowspan="3">0.03 < W</td> <td rowspan="3">0.1</td> <td colspan="2">L 2.0</td> <td>(Neglected)</td> </tr> <tr> <td colspan="2">2.0 < L 4.0</td> <td>3</td> </tr> <tr> <td colspan="2">4.0 < L</td> <td>0</td> </tr> <tr> <td colspan="2">0.1 < W</td> <td colspan="2">-</td> <td>(According to circular shape)</td> </tr> </tbody> </table>			Width (mm)		Length (mm)		Acceptable number	W	0.03	-		(Neglected)	0.03 < W	0.1	L 2.0		(Neglected)	2.0 < L 4.0		3	4.0 < L		0	0.1 < W		-		(According to circular shape)
	Width (mm)		Length (mm)		Acceptable number																								
	W	0.03	-		(Neglected)																								
	0.03 < W	0.1	L 2.0		(Neglected)																								
			2.0 < L 4.0		3																								
4.0 < L			0																										
0.1 < W		-		(According to circular shape)																									

Компания «Океан Электроники» предлагает заключение долгосрочных отношений при поставках импортных электронных компонентов на взаимовыгодных условиях!

Наши преимущества:

- Поставка оригинальных импортных электронных компонентов напрямую с производств Америки, Европы и Азии, а так же с крупнейших складов мира;
- Широкая линейка поставок активных и пассивных импортных электронных компонентов (более 30 млн. наименований);
- Поставка сложных, дефицитных, либо снятых с производства позиций;
- Оперативные сроки поставки под заказ (от 5 рабочих дней);
- Экспресс доставка в любую точку России;
- Помощь Конструкторского Отдела и консультации квалифицированных инженеров;
- Техническая поддержка проекта, помощь в подборе аналогов, поставка прототипов;
- Поставка электронных компонентов под контролем ВП;
- Система менеджмента качества сертифицирована по Международному стандарту ISO 9001;
- При необходимости вся продукция военного и аэрокосмического назначения проходит испытания и сертификацию в лаборатории (по согласованию с заказчиком);
- Поставка специализированных компонентов военного и аэрокосмического уровня качества (Xilinx, Altera, Analog Devices, Intersil, Interpoint, Microsemi, Actel, Aeroflex, Peregrine, VPT, Syfer, Eurofarad, Texas Instruments, MS Kennedy, Miteq, Cobham, E2V, MA-COM, Hittite, Mini-Circuits, General Dynamics и др.);

Компания «Океан Электроники» является официальным дистрибьютором и эксклюзивным представителем в России одного из крупнейших производителей разъемов военного и аэрокосмического назначения «JONHON», а так же официальным дистрибьютором и эксклюзивным представителем в России производителя высокотехнологичных и надежных решений для передачи СВЧ сигналов «FORSTAR».



JONHON

«JONHON» (основан в 1970 г.)

Разъемы специального, военного и аэрокосмического назначения:

(Применяются в военной, авиационной, аэрокосмической, морской, железнодорожной, горно- и нефтедобывающей отраслях промышленности)

«FORSTAR» (основан в 1998 г.)

ВЧ соединители, коаксиальные кабели, кабельные сборки и микроволновые компоненты:

(Применяются в телекоммуникациях гражданского и специального назначения, в средствах связи, РЛС, а так же военной, авиационной и аэрокосмической отраслях промышленности).



Телефон: 8 (812) 309-75-97 (многоканальный)

Факс: 8 (812) 320-03-32

Электронная почта: ocean@oceanchips.ru

Web: <http://oceanchips.ru/>

Адрес: 198099, г. Санкт-Петербург, ул. Калинина, д. 2, корп. 4, лит. А