

.....
Wire-Wound - 0402, 0603, 0805, 1008, 1206

RF Chip Inductors



WIRE-WOUND RF CHIP INDUCTORS



Pulse is one of the largest magnetic component design and manufacturing companies in the world. With over 19,000 employees worldwide and an extensive line of state-of-the-art magnetic solutions, Pulse has become a leading supplier of magnetic components to OEMs and Contract Manufacturers in data networking, connectivity, digital telecommunications including wireless communications, broadband/Internet, cable modems and most forms of power conversion.

In addition, Pulse designs and manufactures end-user products such as DSL filters and splitters (Excelsus[®] products), as well as components used in consumer products such as personal computers, cable modems, TVs, DVDs, PDAs, digital cameras, and set-top boxes.

Engineering design centers and manufacturing facilities in North America, Europe and Asia supply product to a broad international customer base. Sales and service operations in the United States, Canada, United Kingdom, France, Italy, Singapore, Hong Kong and Taiwan, as well as authorized distributors and representatives worldwide, support Pulse customers around the globe. The company offers a complete line of magnetic components and modules for use in T1 telecommunications, Internet/broadband access, VoIP, DSL, Ethernet data networking up to one Gigabit, AC-DC, DC-DC and UPS power conversion and communication, and power conversion for military/aerospace applications. This extensive catalog of standard products is available through distributors worldwide.

With the acquisition of Eldor (Italy) in 2003, Pulse is now a leading worldwide supplier of magnetics for consumer applications, offering a wide range of product platforms including flyback transformers (FBTs), power switch-mode transformers (SMTs) and other inductive components for TV, DVD, set-top boxes and LCD TV monitors. Pulse has the industry's widest range of inductive solutions to designers and producers in the emerging digital consumer products markets.

Pulse has a wide range of capabilities to support customers. Real-time programs track current product development, vendor delivery and production status. They also schedule available delivery dates and support product delivery programs such as vendor-managed inventory, consignment and EDI ordering.

Pulse is proactive in developing industry standard products to ensure that its customers receive high-performance, high-quality and high-reliability products. Pulse is a member of and actively participates in IEEE, ANSI, T1/E1 and the DSL Forum. As an example, Pulse is a team member of the standards committee developing DSL products that allow broadband connectivity via household telephone lines.

Ongoing research and development at Pulse has resulted in multiple product patents along with several unique manufacturing processes. Likewise, Engineering design centers around the world can provide custom designs for applications not generally available in the current, Pulse catalog product lines.

Pulse works closely with the major semiconductor manufacturers (that provide the ICs controlling computer networks, DSL and telecommunications and power conversion electronics) to develop standard magnetic components that exactly match the magnetic requirements of the IC. These semiconductor companies recommend Pulse magnetics on their datasheets. Committed to delivering high-performance products, advanced technologies, and world-class quality, Pulse supports the electronics industry and end-user with competitively priced products and services.

The 0402 to 1206 series of Miniature RF Inductors all contain wirewound technology and ceramic or ferrite cores, thus providing the ultimate performance demanded by today's RF applications. Inductors feature high Qs and SRFs and an industry standard size and footprint. Tighter inductance tolerances are available. CD, CM, CQ, and FT Series inductors are available in Tin or Gold terminations. Sample kits are available from Pulse for all series. Please refer to page 2 for part numbers. Use the Product Finder on the Pulse web site: <http://www.pulseeng.com/Products>

WIRE-WOUND RF CHIP INDUCTORS



The 0402 to 1206 series range of Miniature Chip Inductors contains the very latest in wire-wound technology and Ceramic or Ferrite Core, thus providing the ultimate in performance demanded by today's Wireless products. The Inductors provide high Q and SRFs in an industry standard size and footprint. Pulse chip inductors manufactured after February, 2005 are in compliance with RoHS requirements.

TABLE of CONTENTS

| | |
|---|-------|
| <i>Part Number Legend & Design Kits Available</i> | 2 |
| <i>Selection Guide</i> | 3 |
| <i>Performance Specifications</i> | |
| Environmental Testing | 4 |
| Mechanical Testing | 4-5 |
| Tape and Reel Specification | 5 |
| <i>Miniature Wire-wound RF Chip Inductors</i> | |
| 0402CD Series | 6-7 |
| 0603CD Series | 8-9 |
| 0805CD Series | 10-11 |
| 0805CM Series | 12-13 |
| 0805FT Series | 14-15 |
| 1008CD Series | 16-17 |
| 1008CM Series | 18-19 |
| 1008CQ Series | 20-21 |
| 1206CD Series | 22-23 |
| <i>Application Notes</i> | 24-27 |

WIRE-WOUND RF CHIP INDUCTORS



Part Number Legend



Design Kits Available from Pulse



| Product KIT Series | Kit Part Number | Tolerance |
|--------------------|-----------------|-----------|
| 0402CD Series | PE-0402CDKIT-T | 2% |
| 0603CD Series | PE-0603CDKIT-T | 2% |
| 0805CD Series | PE-0805CDKIT-T | 2% |
| 1008CD Series | PE-1008CDKIT-T | 2% |

NOTE: 0805CM, 1008CM and 1008CQ design kits are not available at this time.

WIRE-WOUND RF CHIP INDUCTORS

Selection Guides



Electrical Specifications

| Part Number | Size | Construction | Inductance (nH) | 1 | 10 | 100 | 1 | 10 | 100 | 1000 | | |
|-------------|------|--------------|-----------------|--|----|-----|---|----|-----|------|--|--|
| 0402CD | 0402 | Wirewound | 1.0 to 120 | [Bar chart showing inductance range from 1 to 100 nH] | | | | | | | | |
| 0603CD | 0603 | Wirewound | 1.6 to 390 | [Bar chart showing inductance range from 10 to 100 nH] | | | | | | | | |
| 0805CD | 0805 | Wirewound | 2.8 to 1500 | [Bar chart showing inductance range from 10 to 100 nH] | | | | | | | | |
| 0805CM | 0805 | Wirewound | 3.3 to 820 | [Bar chart showing inductance range from 10 to 100 nH] | | | | | | | | |
| 0805FT | 0805 | Wirewound | 1000 to 68000 | | | | [Bar chart showing inductance range from 1 to 100 nH] | | | | | |
| 1008CD | 1008 | Wirewound | 9.7 to 8200 | [Bar chart showing inductance range from 10 to 100 nH] | | | | | | | | |
| 1008CM | 1008 | Wirewound | 10 to 4700 | [Bar chart showing inductance range from 10 to 100 nH] | | | | | | | | |
| 1008CQ | 1008 | Wirewound | 4.1 to 390 | [Bar chart showing inductance range from 10 to 100 nH] | | | | | | | | |
| 1206CD | 1206 | Wirewound | 3.3 to 1200 | [Bar chart showing inductance range from 10 to 100 nH] | | | | | | | | |

CD Series: Standard 100% compatible with other market leaders.

CM Series: Offers improved electrical performance or alternative inductance values to Pulse CD series.

CQ Series: Offers high Q and high Idc series.

FT Series: Ferrite core offers higher inductance values.

Competition Cross Reference

| Type | Competition | Pulse Wire-wound Inductors | | | | | | |
|------------|-------------|----------------------------|--------|--------------|--------|--------|--------------|--------|
| | | 0402CD | 0603CD | 0805CD | 0805FT | 1008CQ | 1008CD | 1206CD |
| Wire Wound | Coilcraft | 0402CS | 0603CS | 0805CS/HS/HT | | 1008HQ | 1008CS/HT/CT | 1206CS |
| | Murata | | | LQW1608A | | | LQN21A | |
| | Taiyo Yuden | | | LB2012T | | | LEM_2520T | |
| | TDK | | | | NL2016 | | NLH2520 | |

WIRE-WOUND RF CHIP INDUCTORS

Performance Specifications



Environmental Testing

| | | |
|---|--|--|
| Storage and Operating Temperature Range: -40 to +125°C | Inductors are subjected to the extremes for 48 hours. Then tested at 25°C | There shall be no deformation or change in appearance Inductance shall not change by more than $\pm 5\%$ Q values shall not change by more than $\pm 10\%$ |
| Thermal Shock: -40 to +85°C | Inductors are subjected to 30 cycles for 30 minutes at each extreme. Then tested at 25°C | |
| Moisture Resistance | Inductors are subjected to 10 cycles of 24 hours at 70°C with 90 to 95% Relative Humidity Then tested at 25°C | |
| Operating Life | Inductors are subjected to 1000 hours at 85°C with 85% Relative Humidity with the rated current applied | There shall be no Damaged, Open or Shorted Windings |

Mechanical Testing

| | | |
|---------------------------|---|--|
| Temperature Range: | Inductors are subjected to the following: Use a solder pot at 260°C, with RMA Flux. Each termination is immersed in 63Sn/37Pb molten solder for 4 to 6 seconds. | There shall be no deformation or change in appearance Inductance shall not change by more than $\pm 5\%$ Q values shall not change by more than $\pm 10\%$ |
|---------------------------|---|--|

Recommended Solder Heat Resistance Profile



WIRE-WOUND RF CHIP INDUCTORS

Performance Specifications



Mechanical Testing

| | | |
|----------------------------|---|--|
| Vibration (Random) | Samplers are subjected to random vibration as per NAVMAT P9492 | There shall be no deformation or change in appearance Inductance shall not change by more than $\pm 5\%$ Q values shall not change by more than $\pm 10\%$ |
| Mechanical Shock | Inductors are subjected to one half sine wave pulse (8700 g's for 0.3 ms) in each directional axis for a total of 18 shocks | |
| Moisture Resistance | Reflow Inductors on to test pads using 63 Sn/37 Pb solder paste (IR Reflow profile = 200°C for 30 seconds or peak 235°C for 20 seconds) | The inductors shall withstand a minimum force of 1000 g's in any direction using a dynamometer force guage. |

Tape and Reel Specifications



Packaging Specifications

| Series | Parts per Reel | Reel Dimensions (mm) | | | | | Tape Dimensions (mm) | | | | | |
|--------|----------------|----------------------|-----|----|------|------|----------------------|----|----|----|-----|-----|
| | | A | B | C | D | E | W | P1 | P2 | P3 | H | T |
| 0402CD | 3000 | 178 | 50 | 13 | 14.4 | 8.4 | 8 | 2 | 4 | 4 | 1.1 | 0.3 |
| 0603CD | 2000 | 178 | 50 | 13 | 14.4 | 8.4 | 8 | 2 | 4 | 4 | 1.7 | 0.3 |
| 0805CD | 2000 | 178 | 50 | 13 | 14.4 | 8.4 | 8 | 2 | 4 | 4 | 2.1 | 0.3 |
| 0805CM | 2000 | 178 | 50 | 13 | 14.4 | 8.4 | 8 | 2 | 4 | 4 | 2.1 | 0.3 |
| 0805FT | 2000 | 178 | 50 | 13 | 14.4 | 8.4 | 8 | 2 | 4 | 4 | 2.1 | 0.3 |
| 1008CD | 1600 | 178 | 50 | 13 | 14.4 | 8.4 | 8 | 2 | 4 | 4 | 2.6 | 0.3 |
| 1008CM | 1600 | 178 | 50 | 13 | 14.4 | 8.4 | 8 | 2 | 4 | 4 | 2.6 | 0.3 |
| 1008CQ | 1600 | 178 | 50 | 13 | 14.4 | 8.4 | 8 | 2 | 4 | 4 | 2.6 | 0.3 |
| 1206CD | 3000 | 330 | 101 | 13 | 18.4 | 12.4 | 12 | 2 | 4 | 4 | 2.0 | 0.4 |

NOTE: P1, P2 and P3 are same for all chip inductor series. Keeping the same dimensions for guide hole and pocket pitch (P1), pocket pitch (P2), guide hole pitch (P3) and tape width (8mm) for all series, enables the packaging machine to maintain the same settings while changing models. The only difference between the series are the parts per reel which contribute to a different length of tapes/reel per model.

WIRE-WOUND RF CHIP INDUCTORS - 0402CD SERIES



-  Wirewound ceramic core construction
-  High Q values
-  High self resonant frequency
-  Industry standard 0402 (1005) surface mount land pattern



See page 3 for Competition Cross Reference

Electrical Specifications @ 25°C

| Part Number | Inductance 1 (nH) | Standard Tolerance | Optional Tolerance | Q 2 (MIN) | SRF 3 (MHz MIN) | R _{dc} (Ω MAX) | I _{pc} (mA MAX) |
|-----------------|----------------------|-----------------------|-----------------------|--------------|--------------------|----------------------------|-----------------------------|
| PE-0402CD1N0KTT | 1.0 @ 250MHz | ±0.3nH (S) | ±0.2nH (B) | 13 @ 250MHz | 6000 | 0.045 | 1360 |
| PE-0402CD1N2KTT | 1.2 @ 250MHz | ±10% (K) | ±5% (J), ±2% (G) | 13 @ 250MHz | 6000 | 0.060 | 1300 |
| PE-0402CD1N8KTT | 1.8 @ 250MHz | ±10% (K) | ±5% (J), ±2% (G) | 16 @ 250MHz | 6000 | 0.070 | 1040 |
| PE-0402CD1N9KTT | 1.9 @ 250MHz | ±10% (K) | ±5% (J), ±2% (G) | 16 @ 250MHz | 6000 | 0.070 | 1040 |
| PE-0402CD2N0KTT | 2.0 @ 250MHz | ±10% (K) | ±5% (J), ±2% (G) | 16 @ 250MHz | 6000 | 0.070 | 1040 |
| PE-0402CD2N2KTT | 2.2 @ 250 MHz | ±10% (K) | ±5% (J), ±2% (G) | 18 @ 250MHz | 6000 | 0.070 | 960 |
| PE-0402CD2N4KTT | 2.4 @ 250MHz | ±10% (K) | ±5% (J), ±2% (G) | 18 @ 250MHz | 6000 | 0.068 | 900 |
| PE-0402CD2N7KTT | 2.7 @ 250MHz | ±10% (K) | ±5% (J) | 18 @ 250MHz | 6000 | 0.120 | 860 |
| PE-0402CD3N3KTT | 3.3 @ 250MHz | ±10% (K) | ±5% (J), ±2% (G) | 20 @ 250MHz | 6000 | 0.066 | 840 |
| PE-0402CD3N6KTT | 3.6 @ 250MHz | ±10% (K) | ±5% (J), ±2% (G) | 20 @ 250MHz | 6000 | 0.066 | 840 |
| PE-0402CD3N9KTT | 3.9 @ 250MHz | ±10% (K) | ±5% (J), ±2% (G) | 20 @ 250MHz | 5800 | 0.066 | 840 |
| PE-0402CD4N3KTT | 4.3 @ 250MHz | ±10% (K) | ±5% (J), ±2% (G) | 20 @ 250MHz | 5800 | 0.091 | 640 |
| PE-0402CD4N7KTT | 4.7 @ 250MHz | ±10% (K) | ±5% (J), ±2% (G) | 20 @ 250MHz | 4775 | 0.130 | 640 |
| PE-0402CD5N1KTT | 5.1 @ 250MHz | ±10% (K) | ±5% (J), ±2% (G) | 23 @ 250MHz | 5800 | 0.083 | 800 |
| PE-0402CD5N6KTT | 5.6 @ 250MHz | ±10% (K) | ±5% (J), ±2% (G) | 23 @ 250MHz | 5800 | 0.083 | 760 |
| PE-0402CD6N2KTT | 6.2 @ 250MHz | ±10% (K) | ±5% (J), ±2% (G) | 23 @ 250MHz | 5800 | 0.083 | 760 |
| PE-0402CD6N8KTT | 6.8 @ 250MHz | ±10% (K) | ±5% (J), ±2% (G) | 20 @ 250MHz | 5800 | 0.083 | 680 |
| PE-0402CD7N5KTT | 7.5 @ 250MHz | ±10% (K) | ±5% (J), ±2% (G) | 25 @ 250MHz | 5800 | 0.104 | 680 |
| PE-0402CD8N2KTT | 8.2 @ 250MHz | ±10% (K) | ±5% (J), ±2% (G) | 25 @ 250MHz | 4400 | 0.104 | 680 |
| PE-0402CD8N7KTT | 8.7 @ 250MHz | ±10% (K) | ±5% (J) | 21 @ 250MHz | 4100 | 0.200 | 680 |
| PE-0402CD9N0KTT | 9.0 @ 250MHz | ±10% (K) | ±5% (J), ±2% (G) | 25 @ 250MHz | 4160 | 0.104 | 680 |
| PE-0402CD9N5KTT | 9.5 @ 250MHz | ±10% (K) | ±5% (J), ±2% (G) | 21 @ 250MHz | 4000 | 0.200 | 600 |
| PE-0402CD100KTT | 10 @ 250MHz | ±10% (K) | ±5% (J), ±2% (G) | 21 @ 250MHz | 3900 | 0.195 | 480 |
| PE-0402CD110KTT | 11 @ 250MHz | ±10% (K) | ±5% (J), ±2% (G) | 26 @ 250MHz | 3680 | 0.120 | 640 |
| PE-0402CD120KTT | 12 @ 250MHz | ±10% (K) | ±5% (J), ±2% (G) | 26 @ 250MHz | 3600 | 0.120 | 640 |
| PE-0402CD130KTT | 13 @ 250MHz | ±10% (K) | ±5% (J), ±2% (G) | 26 @ 250MHz | 3450 | 0.210 | 600 |
| PE-0402CD150KTT | 15 @ 250MHz | ±10% (K) | ±5% (J), ±2% (G) | 26 @ 250MHz | 3280 | 0.172 | 560 |
| PE-0402CD160KTT | 16 @ 250MHz | ±10% (K) | ±5% (J), ±2% (G) | 26 @ 250MHz | 3100 | 0.220 | 560 |
| PE-0402CD180KTT | 18 @ 250MHz | ±10% (K) | ±5% (J), ±2% (G) | 26 @ 250MHz | 3100 | 0.230 | 520 |
| PE-0402CD190KTT | 19 @ 250MHz | ±10% (K) | ±5% (J), ±2% (G) | 26 @ 250MHz | 3040 | 0.202 | 480 |
| PE-0402CD200KTT | 20 @ 250MHz | ±10% (K) | ±5% (J), ±2% (G) | 26 @ 250MHz | 3000 | 0.250 | 480 |
| PE-0402CD220KTT | 22 @ 250MHz | ±10% (K) | ±5% (J), ±2% (G) | 26 @ 250MHz | 2800 | 0.300 | 400 |
| PE-0402CD230KTT | 23 @ 250MHz | ±10% (K) | ±5% (J), ±2% (G) | 26 @ 250MHz | 2720 | 0.214 | 400 |
| PE-0402CD240KTT | 24 @ 250MHz | ±10% (K) | ±5% (J) | 26 @ 250MHz | 2700 | 0.300 | 400 |
| PE-0402CD270KTT | 27 @ 250MHz | ±10% (K) | ±5% (J), ±2% (G) | 26 @ 250MHz | 2480 | 0.298 | 400 |

(Continued on next page)

WIRE-WOUND RF CHIP INDUCTORS - 0402CD SERIES



Electrical Specifications @ 25°C (continued)

| Part Number | Inductance 1 (nH) | Standard Tolerance | Optional Tolerance | Q 2 (MIN) | SRF 3 (MHz MIN) | R _{DC} (Ω MAX) | I _{bc} (mA MAX) |
|-----------------|-------------------|--------------------|--------------------|-------------|-----------------|-------------------------|--------------------------|
| PE-0402CD300KTT | 30 @ 250MHz | ±10% (K) | ±5% (J), ±2% (G) | 25 @ 250MHz | 2350 | 0.300 | 350 |
| PE-0402CD330KTT | 33 @ 250MHz | ±10% (K) | ±5% (J), ±2% (G) | 24 @ 250MHz | 2350 | 0.350 | 350 |
| PE-0402CD360KTT | 36 @ 250MHz | ±10% (K) | ±5% (J), ±2% (G) | 26 @ 250MHz | 2320 | 0.403 | 320 |
| PE-0402CD390KTT | 39 @ 250MHz | ±10% (K) | ±5% (J), ±2% (G) | 25 @ 250MHz | 2100 | 0.550 | 320 |
| PE-0402CD400KTT | 40 @ 250MHz | ±10% (K) | ±5% (J), ±2% (G) | 26 @ 250MHz | 2240 | 0.438 | 320 |
| PE-0402CD430KTT | 43 @ 250MHz | ±10% (K) | ±5% (J), ±2% (G) | 25 @ 250MHz | 2030 | 0.810 | 240 |
| PE-0402CD470KTT | 47 @ 250MHz | ±10% (K) | ±5% (J), ±2% (G) | 20 @ 250MHz | 2100 | 0.830 | 100 |
| PE-0402CD510KTT | 51 @ 250MHz | ±10% (K) | ±5% (J), ±2% (G) | 25 @ 250MHz | 1750 | 0.820 | 100 |
| PE-0402CD560KTT | 56 @ 250MHz | ±10% (K) | ±5% (J), ±2% (G) | 22 @ 250MHz | 1750 | 0.970 | 100 |
| PE-0402CD680KTT | 68 @ 250MHz | ±10% (K) | ±5% (J), ±2% (G) | 18 @ 250MHz | 1840 | 0.970 | 100 |
| PE-0402CD820KTT | 82 @ 250MHz | ±10% (K) | ±5% (J), ±2% (G) | 16 @ 250MHz | 1680 | 1.250 | 100 |
| PE-0402CD101KTT | 100 @ 250MHz | ±10% (K) | ±5% (J), ±2% (G) | 16 @ 250MHz | 1620 | 2.600 | 100 |
| PE-0402CD121KTT | 120 @ 250MHz | ±10% (K) | ±5% (J), ±2% (G) | 14 @ 250MHz | 1520 | 2.700 | 90 |

Notes:

- Inductance measured using a HP4286A RF Impedance Analyzer. (Please note that inductance information is not stamped on part, because of the extremely small size).
- Q measured using a HP4291A RF Impedance Analyzer with a HP16193A Test Fixture.
- SRF measured using a HP8753C Network Analyzer.
- R_{DC} measured using a Valhalla Scientific model 4100 ATC Digital Ohmmeter.
- Based on a 15°C maximum temperature rise.
- Sample Kit Part Number: **PE-0402CDKIT-T**
- Component Weight: 0.002 grams typical.

Typical Q vs Frequency



Typical Inductance vs Frequency



Mechanical



WIRE-WOUND RF CHIP INDUCTORS - 0603CD SERIES



-  Wirewound ceramic core construction
-  High Q values
-  High self resonant frequency
-  Industry standard 0603 (1608) surface mount land pattern



See page 3 for Competition Cross Reference

Electrical Specifications @ 25°C

| Part Number | Inductance ¹ (nH) | Standard Tolerance | Optional Tolerance | Q ² (MIN) | SRF ³ (MHz MIN) | Rdc ⁴ (Ω MAX) | I _{dc} ⁵ (mA MAX) |
|-----------------|---------------------------------|-----------------------|-----------------------|-------------------------|-------------------------------|-----------------------------|--|
| PE-0603CD1N6KTT | 1.6 @ 250MHz | ±10% (K) | ±5% (J), ±2% (G) | 24 @ 250MHz | >6000 | 0.030 | 700 |
| PE-0603CD010KTT | 1.7 @ 250MHz | ±10% (K) | ±5% (J), ±2% (G) | 16 @ 250MHz | >6000 | 0.050 | 700 |
| PE-0603CD1N8KTT | 1.8 @ 250MHz | ±10% (K) | ±5% (J), ±2% (G) | 16 @ 250MHz | >6000 | 0.045 | 700 |
| PE-0603CD2N2KTT | 2.2 @ 250MHz | ±10% (K) | ±5% (J), ±2% (G) | 18 @ 250MHz | >6000 | 0.110 | 700 |
| PE-0603CD3N3KTT | 3.3 @ 250MHz | ±10% (K) | ±5% (J), ±2% (G) | 35 @ 250MHz | >6000 | 0.045 | 700 |
| PE-0603CD3N6KTT | 3.6 @ 250MHz | ±10% (K) | ±5% (J), ±2% (G) | 20 @ 250MHz | >6000 | 0.070 | 700 |
| PE-0603CD030KTT | 3.9 @ 250MHz | ±10% (K) | ±5% (J), ±2% (G) | 20 @ 250MHz | >6000 | 0.080 | 700 |
| PE-0603CD4N3KTT | 4.3 @ 250MHz | ±10% (K) | ±5% (J), ±2% (G) | 20 @ 250MHz | >6000 | 0.102 | 700 |
| PE-0603CD040KTT | 4.55 @ 250MHz | ±10% (K) | ±5% (J), ±2% (G) | 20 @ 250MHz | 5800 | 0.106 | 700 |
| PE-0603CD4N7KTT | 4.7 @ 250MHz | ±10% (K) | ±5% (J), ±2% (G) | 20 @ 250MHz | 5800 | 0.116 | 700 |
| PE-0603CD5N1KTT | 5.1 @ 250MHz | ±10% (K) | ±5% (J), ±2% (G) | 20 @ 250MHz | 5700 | 0.108 | 700 |
| PE-0603CD5N6KTT | 5.6 @ 250MHz | ±10% (K) | ±5% (J), ±2% (G) | 25 @ 250MHz | 5500 | 0.108 | 700 |
| PE-0603CD6N2KTT | 6.2 @ 250MHz | ±10% (K) | ±5% (J), ±2% (G) | 25 @ 250MHz | 5800 | 0.110 | 700 |
| PE-0603CD060KTT | 6.68 @ 250MHz | ±10% (K) | ±5% (J), ±2% (G) | 25 @ 250MHz | 5800 | 0.110 | 700 |
| PE-0603CD6N8KTT | 6.8 @ 250MHz | ±10% (K) | ±5% (J), ±2% (G) | 27 @ 250MHz | 5800 | 0.110 | 700 |
| PE-0603CD7N5KTT | 7.5 @ 250MHz | ±10% (K) | ±5% (J), ±2% (G) | 28 @ 250MHz | 4800 | 0.115 | 700 |
| PE-0603CD080KTT | 8.2 @ 250MHz | ±10% (K) | ±5% (J), ±2% (G) | 30 @ 250MHz | 4600 | 0.120 | 700 |
| PE-0603CD8N7KTT | 8.7 @ 250MHz | ±10% (K) | ±5% (J), ±2% (G) | 28 @ 250MHz | 4600 | 0.109 | 700 |
| PE-0603CD9N5KTT | 9.5 @ 250MHz | ±10% (K) | ±5% (J), ±2% (G) | 28 @ 250MHz | 5400 | 0.135 | 700 |
| PE-0603CD100KTT | 10 @ 250MHz | ±10% (K) | ±5% (J), ±2% (G) | 30 @ 250MHz | 4800 | 0.130 | 700 |
| PE-0603CD110KTT | 11 @ 250MHz | ±10% (K) | ±5% (J), ±2% (G) | 30 @ 250MHz | 4000 | 0.086 | 700 |
| PE-0603CD120KTT | 12 @ 250MHz | ±10% (K) | ±5% (J), ±2% (G) | 30 @ 250MHz | 4000 | 0.130 | 700 |
| PE-0603CD130KTT | 13 @ 250MHz | ±10% (K) | ±5% (J), ±2% (G) | 38 @ 250MHz | 3600 | 0.106 | 700 |
| PE-0603CD150KTT | 15 @ 250MHz | ±10% (K) | ±5% (J), ±2% (G) | 30 @ 250MHz | 4000 | 0.170 | 700 |
| PE-0603CD160KTT | 16 @ 250MHz | ±10% (K) | ±5% (J), ±2% (G) | 35 @ 250MHz | 3300 | 0.170 | 700 |
| PE-0603CD180KTT | 18 @ 250MHz | ±10% (K) | ±5% (J), ±2% (G) | 35 @ 250MHz | 3100 | 0.170 | 700 |
| PE-0603CD220KTT | 22 @ 250MHz | ±10% (K) | ±5% (J), ±2% (G) | 35 @ 250MHz | 3000 | 0.190 | 700 |
| PE-0603CD230KTT | 23 @ 250MHz | ±10% (K) | ±5% (J), ±2% (G) | 38 @ 250MHz | 2850 | 0.190 | 700 |
| PE-0603CD240KTT | 24 @ 250MHz | ±10% (K) | ±5% (J), ±2% (G) | 35 @ 250MHz | 2650 | 0.200 | 600 |
| PE-0603CD270KTT | 27 @ 250MHz | ±10% (K) | ±5% (J), ±2% (G) | 35 @ 250MHz | 2800 | 0.220 | 600 |
| PE-0603CD300KTT | 30 @ 250MHz | ±10% (K) | ±5% (J), ±2% (G) | 37 @ 250MHz | 2250 | 0.144 | 600 |
| PE-0603CD330KTT | 33 @ 250MHz | ±10% (K) | ±5% (J), ±2% (G) | 35 @ 250MHz | 2300 | 0.220 | 600 |
| PE-0603CD360KTT | 36 @ 250MHz | ±10% (K) | ±5% (J), ±2% (G) | 37 @ 250MHz | 2080 | 0.250 | 600 |
| PE-0603CD390KTT | 39 @ 250MHz | ±10% (K) | ±5% (J), ±2% (G) | 35 @ 250MHz | 2200 | 0.250 | 600 |
| PE-0603CD430KTT | 43 @ 250MHz | ±10% (K) | ±5% (J), ±2% (G) | 35 @ 250MHz | 2000 | 0.280 | 600 |
| PE-0603CD470KTT | 47 @ 200MHz | ±10% (K) | ±5% (J), ±2% (G) | 35 @ 200MHz | 2000 | 0.280 | 600 |
| PE-0603CD510KTT | 51 @ 200MHz | ±10% (K) | ±5% (J), ±2% (G) | 35 @ 200MHz | 1900 | 0.270 | 600 |
| PE-0603CD560KTT | 56 @ 200MHz | ±10% (K) | ±5% (J), ±2% (G) | 35 @ 200MHz | 1900 | 0.310 | 600 |
| PE-0603CD680KTT | 68 @ 200MHz | ±10% (K) | ±5% (J), ±2% (G) | 35 @ 200MHz | 1700 | 0.340 | 600 |
| PE-0603CD720KTT | 72 @ 150MHz | ±10% (K) | ±5% (J), ±2% (G) | 34 @ 150MHz | 1700 | 0.490 | 400 |

(Continued on next page)

WIRE-WOUND RF CHIP INDUCTORS - 0603CD SERIES



Electrical Specifications @ 25°C (continued)

| Part Number | Inductance ¹ (nH) | Standard Tolerance | Optional Tolerance | Q ² (MIN) | SRF ³ (MHz MIN) | R _{DC} ⁴ (Ω MAX) | I _{DC} ⁵ (mA MAX) |
|-----------------|---------------------------------|-----------------------|-----------------------|-------------------------|-------------------------------|---|--|
| PE-0603CD820KTT | 82 @ 150MHz | ±10% (K) | ±5% (J), ±2% (G) | 34 @ 150MHz | 1700 | 0.540 | 400 |
| PE-0603CD101KTT | 98.50 @ 150MHz | ±10% (K) | ±5% (J), ±2% (G) | 34 @ 150MHz | 1400 | 0.580 | 400 |
| PE-0603CDR10KTT | 100 @ 150MHz | ±10% (K) | ±5% (J), ±2% (G) | 34 @ 150MHz | 1400 | 0.580 | 400 |
| PE-0603CD111KTT | 110 @ 150MHz | ±10% (K) | ±5% (J), ±2% (G) | 33 @ 150MHz | 1300 | 0.610 | 300 |
| PE-0603CDR12KTT | 120 @ 150MHz | ±10% (K) | ±5% (J), ±2% (G) | 32 @ 150MHz | 1300 | 0.650 | 300 |
| PE-0603CD121KTT | 122 @ 150MHz | ±10% (K) | ±5% (J), ±2% (G) | 33 @ 150MHz | 1300 | 0.650 | 300 |
| PE-0603CD151KTT | 150 @ 150MHz | ±10% (K) | ±5% (J), ±2% (G) | 28 @ 150MHz | 990 | 0.920 | 280 |
| PE-0603CD181KTT | 180 @ 100MHz | ±10% (K) | ±5% (J), ±2% (G) | 25 @ 100MHz | 990 | 1.250 | 240 |
| PE-0603CD201KTT | 200 @ 100MHz | ±10% (K) | ±5% (J), ±2% (G) | 25 @ 100MHz | 900 | 1.980 | 240 |
| PE-0603CD211KTT | 210 @ 100MHz | ±10% (K) | ±5% (J), ±2% (G) | 27 @ 100MHz | 895 | 2.060 | 220 |
| PE-0603CD221KTT | 220 @ 100MHz | ±10% (K) | ±5% (J), ±2% (G) | 25 @ 100MHz | 900 | 1.900 | 200 |
| PE-0603CD251KTT | 250 @ 100MHz | ±10% (K) | ±5% (J), ±2% (G) | 25 @ 100MHz | 822 | 3.550 | 180 |
| PE-0603CD271KTT | 270 @ 100MHz | ±10% (K) | ±5% (J), ±2% (G) | 24 @ 100MHz | 860 | 2.300 | 170 |
| PE-0603CD331KTT | 330 @ 100MHz | ±10% (K) | ±5% (J), ±2% (G) | 22 @ 100MHz | 500 | 2.300 | 150 |
| PE-0603CD391KTT | 390 @ 100MHz | ±10% (K) | ±5% (J), ±2% (G) | 20 @ 100 MHz | 350 | 2.900 | 130 |

Notes:

- Inductance measured using a HP4286A RF Impedance Analyzer.
- Q measured using a HP4291A RF Impedance Analyzer with a HP16193A Test Fixture.
- SRF measured using a HP8753C Network Analyzer.
- R_{DC} measured using a Valhalla Scientific model 4100 ATC Digital Ohmmeter.
- Based on a 15°C maximum temperature rise.
- Sample Kit Part Number: **PE-0603CDKIT-T**
- 5-sides or top side epoxy cap.

Typical Q vs Frequency



Typical Inductance vs Frequency



Mechanical



WIRE-WOUND RF CHIP INDUCTORS - 0805CD SERIES



-  Wirewound ceramic core construction
-  High Q values and self resonant frequency
-  Industry standard 0805 (2012) surface mount land pattern



See page 3 for Competition Cross Reference

Electrical Specifications @ 25°C

| Part Number | Inductance ¹ (nH) | Standard Tolerance | Optional Tolerance | Q ² (MIN) | SRF ³ (MHz MIN) | R _{DC} ⁴ (Ω MAX) | I _{DC} ⁵ (mA MAX) |
|-----------------|---------------------------------|-----------------------|---------------------------|-------------------------|-------------------------------|---|--|
| PE-0805CD2N8KTT | 2.8 @ 250MHz | ±10% (K) | ±5% (J), ±2% (G), ±1% (F) | 80 @ 1500MHz | >6000 | 0.06 | 600 |
| PE-0805CD3N0KTT | 3.0 @ 250MHz | ±10% (K) | ±5% (J), ±2% (G), ±1% (F) | 65 @ 1500MHz | >6000 | 0.06 | 600 |
| PE-0805CD030KTT | 3.32 @ 250MHz | ±10% (K) | ±5% (J), ±2% (G), ±1% (F) | 40 @ 1500MHz | 6000 | 0.08 | 600 |
| PE-0805CD050KTT | 5.6 @ 250MHz | ±10% (K) | ±5% (J), ±2% (G), ±1% (F) | 50 @ 1500MHz | 5500 | 0.10 | 600 |
| PE-0805CD060KTT | 6.5 @ 250MHz | ±10% (K) | ±5% (J), ±2% (G), ±1% (F) | 50 @ 1000MHz | 5000 | 0.11 | 600 |
| PE-0805CD7N5KTT | 7.5 @ 250MHz | ±10% (K) | ±5% (J), ±2% (G), ±1% (F) | 50 @ 1000MHz | 4500 | 0.14 | 600 |
| PE-0805CD080KTT | 7.9 @ 250MHz | ±10% (K) | ±5% (J), ±2% (G), ±1% (F) | 50 @ 1000MHz | 4700 | 0.12 | 600 |
| PE-0805CD100KTT | 10.2 @ 250MHz | ±10% (K) | ±5% (J), ±2% (G), ±1% (F) | 50 @ 500MHz | 4100 | 0.14 | 600 |
| PE-0805CD120KTT | 11.9 @ 250MHz | ±10% (K) | ±5% (J), ±2% (G), ±1% (F) | 50 @ 500MHz | 4000 | 0.15 | 600 |
| PE-0805CD150KTT | 14.9 @ 250MHz | ±10% (K) | ±5% (J), ±2% (G), ±1% (F) | 50 @ 500MHz | 3400 | 0.17 | 600 |
| PE-0805CD180KTT | 17.95 @ 250MHz | ±10% (K) | ±5% (J), ±2% (G), ±1% (F) | 50 @ 500MHz | 3300 | 0.20 | 600 |
| PE-0805CD220KTT | 21.7 @ 250MHz | ±10% (K) | ±5% (J), ±2% (G), ±1% (F) | 55 @ 500MHz | 2600 | 0.22 | 500 |
| PE-0805CD240KTT | 24 @ 250MHz | ±10% (K) | ±5% (J), ±2% (G), ±1% (F) | 50 @ 500MHz | 2000 | 0.22 | 500 |
| PE-0805CD270KTT | 26.5 @ 250MHz | ±10% (K) | ±5% (J), ±2% (G), ±1% (F) | 55 @ 500MHz | 2500 | 0.25 | 500 |
| PE-0805CD330KTT | 32.75 @ 250MHz | ±10% (K) | ±5% (J), ±2% (G), ±1% (F) | 60 @ 500MHz | 2050 | 0.27 | 500 |
| PE-0805CD360KTT | 36 @ 250MHz | ±10% (K) | ±5% (J), ±2% (G), ±1% (F) | 55 @ 500MHz | 1700 | 0.27 | 500 |
| PE-0805CD390KTT | 38.5 @ 250MHz | ±10% (K) | ±5% (J), ±2% (G), ±1% (F) | 60 @ 500MHz | 2000 | 0.29 | 500 |
| PE-0805CD430KTT | 43 @ 200MHz | ±10% (K) | ±5% (J), ±2% (G), ±1% (F) | 60 @ 500MHz | 1650 | 0.34 | 500 |
| PE-0805CD470KTT | 46.6 @ 200MHz | ±10% (K) | ±5% (J), ±2% (G), ±1% (F) | 60 @ 500MHz | 1650 | 0.31 | 500 |
| PE-0805CD560KTT | 55.5 @ 200MHz | ±10% (K) | ±5% (J), ±2% (G), ±1% (F) | 60 @ 500MHz | 1550 | 0.34 | 500 |
| PE-0805CD680KTT | 67.8 @ 200MHz | ±10% (K) | ±5% (J), ±2% (G), ±1% (F) | 60 @ 500MHz | 1450 | 0.38 | 500 |
| PE-0805CD820KTT | 82.7 @ 150MHz | ±10% (K) | ±5% (J), ±2% (G), ±1% (F) | 60 @ 500MHz | 1300 | 0.42 | 400 |
| PE-0805CD910KTT | 91 @ 150MHz | ±10% (K) | ±5% (J), ±2% (G), ±1% (F) | 65 @ 500MHz | 1200 | 0.44 | 400 |
| PE-0805CD101KTT | 98.7 @ 150MHz | ±10% (K) | ±5% (J), ±2% (G), ±1% (F) | 60 @ 500MHz | 1200 | 0.46 | 400 |
| PE-0805CD111KTT | 110 @ 150MHz | ±10% (K) | ±5% (J), ±2% (G), ±1% (F) | 50 @ 250MHz | 1000 | 0.48 | 400 |
| PE-0805CD121KTT | 119.7 @ 150MHz | ±10% (K) | ±5% (J), ±2% (G), ±1% (F) | 50 @ 250MHz | 1100 | 0.51 | 400 |
| PE-0805CD151KTT | 149.4 @ 100MHz | ±10% (K) | ±5% (J), ±2% (G), ±1% (F) | 50 @ 250MHz | 920 | 0.56 | 400 |
| PE-0805CD181KTT | 179.6 @ 100MHz | ±10% (K) | ±5% (J), ±2% (G), ±1% (F) | 50 @ 250MHz | 870 | 0.64 | 400 |
| PE-0805CD221KTT | 217 @ 100MHz | ±10% (K) | ±5% (J), ±2% (G), ±1% (F) | 45 @ 250MHz | 850 | 0.70 | 400 |
| PE-0805CD241KTT | 240 @ 100MHz | ±10% (K) | ±5% (J), ±2% (G), ±1% (F) | 44 @ 250MHz | 690 | 1.00 | 350 |
| PE-0805CD271KTT | 269 @ 100MHz | ±10% (K) | ±5% (J), ±2% (G), ±1% (F) | 45 @ 250MHz | 650 | 1.00 | 350 |
| PE-0805CD331KTT | 331 @ 100MHz | ±10% (K) | ±5% (J), ±2% (G), ±1% (F) | 45 @ 250MHz | 600 | 1.40 | 310 |
| PE-0805CD391KTT | 386 @ 100MHz | ±10% (K) | ±5% (J), ±2% (G), ±1% (F) | 35 @ 250MHz | 560 | 1.50 | 290 |
| PE-0805CD471KTT | 477 @ 50MHz | ±10% (K) | ±5% (J), ±2% (G), ±1% (F) | 33 @ 100MHz | 375 | 1.76 | 250 |
| PE-0805CD561KTT | 545 @ 25MHz | ±10% (K) | ±5% (J), ±2% (G), ±1% (F) | 23 @ 50MHz | 340 | 1.90 | 230 |
| PE-0805CD681KTT | 674 @ 25MHz | ±10% (K) | ±5% (J), ±2% (G), ±1% (F) | 23 @ 50MHz | 188 | 2.20 | 190 |
| PE-0805CD821KTT | 783 @ 25MHz | ±10% (K) | ±5% (J), ±2% (G), ±1% (F) | 23 @ 50MHz | 215 | 2.35 | 180 |
| PE-0805CD102KTT | 1000 @ 25MHz | ±10% (K) | ±5% (J), ±2% (G), ±1% (F) | 20 @ 50MHz | 200 | 3.60 | 150 |
| PE-0805CD122KTT | 1200 @ 25MHz | ±10% (K) | ±5% (J), ±2% (G), ±1% (F) | 20 @ 50MHz | 200 | 4.10 | 120 |
| PE-0805CD152KTT | 1500 @ 25MHz | ±10% (K) | ±5% (J), ±2% (G), ±1% (F) | 20 @ 50MHz | 200 | 5.00 | 100 |

For other inductance values in 0805 size, please refer to 0805CM (page 12-13) and 0805FT (page 14-15).

NOTES:

1. Inductance measured with HP4286A RF Impedance Analyzer.
2. Q measured using a HP4291A RF Impedance Analyzer with a HP16193A Test Fixture.
3. SRF measured using a HP8753C Network Analyzer.
4. R_{DC} measured using a Valhalla Scientific model 4100 ATC Digital Ohmmeter.
5. Based on a 15°C maximum temperature rise.
6. Sample Kit Part Number: **PE-0805CDKIT-T**

USA 858 674 8100 • Germany 49 7032 7806 0 • Singapore 65 6287 8998 • Shanghai 86 21 62787060 • China 86 755 33966678 • Taiwan 886 3 4356768

WIRE-WOUND RF CHIP INDUCTORS - 0805CD SERIES



Typical Q vs Frequency



Typical Inductance vs Frequency



Mechanical



Weight 0.012 grams
 Tape & Reel 2000/reel
 Dimensions: Inches
 mm
 Unless otherwise specified
 all tolerances are $\pm .010$

WIRE-WOUND RF CHIP INDUCTORS - 0805CM SERIES



-  Wirewound ceramic core construction
-  High Q values and self resonant frequency
-  Industry standard 0805 (2012) surface mount land pattern



See page 3 for Competition Cross Reference

Electrical Specifications @ 25°C

| Part Number | Inductance ¹ (nH) | Standard Tolerance | Optional Tolerance | Q ² (MIN) | SRF ³ (MHz MIN) | R _{DC} ⁴ (Ω MAX) | I _{DC} ⁵ (mA MAX) |
|-----------------|---------------------------------|-----------------------|-----------------------|-------------------------|-------------------------------|---|--|
| PE-0805CM030KTT | 3.3 @ 250MHz | ±10% (K) | ±5% (J), ±2% (G) | 37 @ 1500MHz | 5000 | 0.08 | 600 |
| PE-0805CM060KTT | 6.8 @ 250MHz | ±10% (K) | ±5% (J), ±2% (G) | 46 @ 1000MHz | 5000 | 0.15 | 600 |
| PE-0805CM080KTT | 8.2 @ 250MHz | ±10% (K) | ±5% (J), ±2% (G) | 47 @ 1000MHz | 3900 | 0.13 | 600 |
| PE-0805CM100KTT | 10 @ 250MHz | ±10% (K) | ±5% (J), ±2% (G) | 60 @ 500MHz | 3900 | 0.10 | 600 |
| PE-0805CM120KTT | 12 @ 250MHz | ±10% (K) | ±5% (J), ±2% (G) | 50 @ 500MHz | 2900 | 0.13 | 600 |
| PE-0805CM150KTT | 15 @ 250MHz | ±10% (K) | ±5% (J), ±2% (G) | 50 @ 500MHz | 2700 | 0.15 | 600 |
| PE-0805CM180KTT | 18 @ 250MHz | ±10% (K) | ±5% (J), ±2% (G) | 50 @ 500MHz | 2600 | 0.13 | 600 |
| PE-0805CM220KTT | 22 @ 250MHz | ±10% (K) | ±5% (J), ±2% (G) | 55 @ 500MHz | 2200 | 0.13 | 500 |
| PE-0805CM270KTT | 27 @ 250MHz | ±10% (K) | ±5% (J), ±2% (G) | 55 @ 500MHz | 2000 | 0.23 | 500 |
| PE-0805CM330KTT | 33 @ 250MHz | ±10% (K) | ±5% (J), ±2% (G) | 58 @ 500MHz | 1800 | 0.18 | 500 |
| PE-0805CM390KTT | 39 @ 250MHz | ±10% (K) | ±5% (J), ±2% (G) | 60 @ 500MHz | 1600 | 0.23 | 500 |
| PE-0805CM470KTT | 47 @ 200MHz | ±10% (K) | ±5% (J), ±2% (G) | 60 @ 500MHz | 1650 | 0.25 | 500 |
| PE-0805CM560KTT | 56 @ 200MHz | ±10% (K) | ±5% (J), ±2% (G) | 60 @ 500MHz | 1300 | 0.16 | 500 |
| PE-0805CM680KTT | 68 @ 200MHz | ±10% (K) | ±5% (J), ±2% (G) | 60 @ 500MHz | 1350 | 0.18 | 500 |
| PE-0805CM820KTT | 82 @ 150MHz | ±10% (K) | ±5% (J), ±2% (G) | 60 @ 500MHz | 1300 | 0.36 | 400 |
| PE-0805CM101KTT | 100 @ 150MHz | ±10% (K) | ±5% (J), ±2% (G) | 55 @ 500MHz | 1100 | 0.36 | 400 |
| PE-0805CM121KTT | 120 @ 150MHz | ±10% (K) | ±5% (J), ±2% (G) | 45 @ 250MHz | 1100 | 0.56 | 350 |
| PE-0805CM151KTT | 150 @ 100MHz | ±10% (K) | ±5% (J), ±2% (G) | 50 @ 250MHz | 900 | 0.56 | 350 |
| PE-0805CM181KTT | 180 @ 100MHz | ±10% (K) | ±5% (J), ±2% (G) | 50 @ 250MHz | 875 | 0.69 | 300 |
| PE-0805CM221KTT | 220 @ 100MHz | ±10% (K) | ±5% (J), ±2% (G) | 45 @ 250MHz | 800 | 0.85 | 300 |
| PE-0805CM271KTT | 270 @ 100MHz | ±10% (K) | ±5% (J), ±2% (G) | 40 @ 100MHz | 800 | 0.90 | 300 |
| PE-0805CM331KTT | 330 @ 100MHz | ±10% (K) | ±5% (J), ±2% (G) | 40 @ 100MHz | 775 | 1.28 | 300 |
| PE-0805CM391KTT | 390 @ 100MHz | ±10% (K) | ±5% (J), ±2% (G) | 40 @ 100MHz | 725 | 1.70 | 300 |
| PE-0805CM471KTT | 470 @ 100MHz | ±10% (K) | ±5% (J), ±2% (G) | 38 @ 100MHz | 600 | 3.25 | 240 |
| PE-0805CM561KTT | 560 @ 100MHz | ±10% (K) | ±5% (J), ±2% (G) | 40 @ 100MHz | 600 | 3.10 | 240 |
| PE-0805CM681KTT | 680 @ 50MHz | ±10% (K) | ±5% (J), ±2% (G) | 32 @ 50MHz | 550 | 3.50 | 240 |
| PE-0805CM821KTT | 820 @ 50MHz | ±10% (K) | ±5% (J), ±2% (G) | 23 @ 50MHz | 215 | 2.35 | 200 |

NOTES:

1. Inductance measured using a HP4286A RF Impedance Analyzer.
2. Q measured using a HP4291A RF Impedance Analyzer with a HP16193A Test Fixture.
3. SRF measured using a HP8753C Network Analyzer.
4. R_{DC} measured using a Valhalla Scientific model 4100 ATC Digital Ohmmeter.
5. Based on a 15°C maximum temperature rise.

WIRE-WOUND RF CHIP INDUCTORS - 0805CM SERIES



Typical Q vs Frequency



Typical Inductance vs Frequency

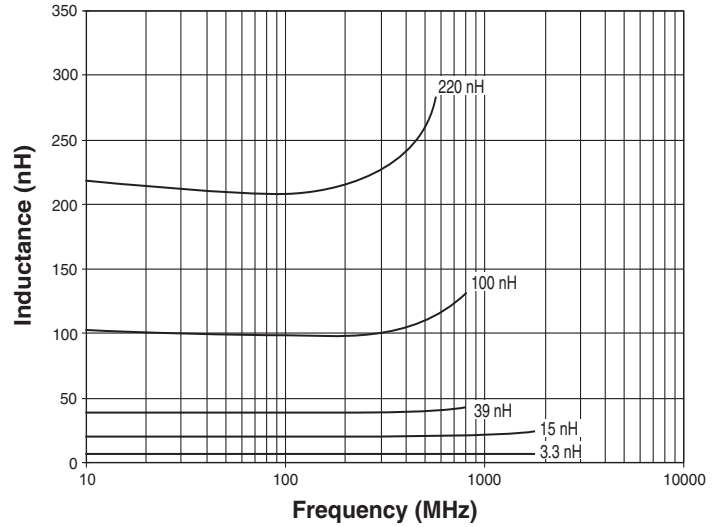

Mechanical

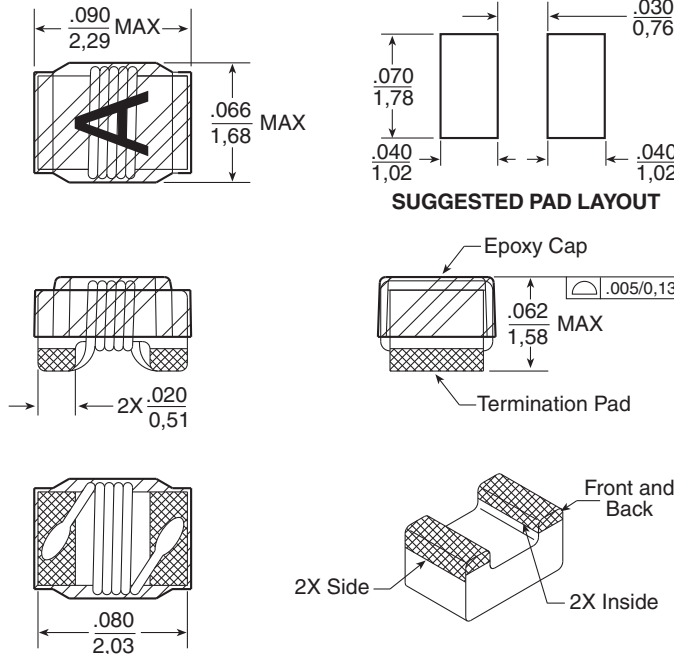

Weight 0.012 grams
Tape & Reel 2000/reel
Dimensions: Inches
mm
Unless otherwise specified
all tolerances are $\pm .010$

WIRE-WOUND RF CHIP INDUCTORS - 0805FT SERIES



-  Wirewound ferrite core construction
-  High Q values and self resonant frequency
-  Industry standard 0805 (2012) surface mount land pattern



See page 3 for Competition Cross Reference

Electrical Specifications @ 25°C

| Part Number | Inductance ¹ (μ H) | Standard Tolerance | Optional Tolerance | Q ² (MIN) | SRF ³ (MHz MIN) | R _{DC} ⁴ (Ω MAX) | I _{DC} ⁵ (mA MAX) |
|-----------------|---------------------------------------|-----------------------|-----------------------|-------------------------|-------------------------------|---|--|
| PE-0805FT102KTT | 1.0 @ 7.96MHz | ±10% (K) | ±5% (J) | 15 @ 7.96MHz | 63 | 1.20 | 245 |
| PE-0805FT152KTT | 1.5 @ 7.96MHz | ±10% (K) | ±5% (J) | 15 @ 7.96MHz | 60 | 1.45 | 225 |
| PE-0805FT222KTT | 2.2 @ 7.96MHz | ±10% (K) | ±5% (J) | 15 @ 7.96MHz | 58 | 1.80 | 200 |
| PE-0805FT332KTT | 3.3 @ 7.96MHz | ±10% (K) | ±5% (J) | 15 @ 7.96MHz | 50 | 2.30 | 175 |
| PE-0805FT472KTT | 4.7 @ 7.96MHz | ±10% (K) | ±5% (J) | 15 @ 7.96MHz | 43 | 2.80 | 140 |
| PE-0805FT682KTT | 6.8 @ 7.96MHz | ±10% (K) | ±5% (J) | 15 @ 7.96MHz | 36 | 3.40 | 115 |
| PE-0805FT103KTT | 10 @ 2.52MHz | ±10% (K) | ±5% (J) | 10 @ 2.52MHz | 30 | 4.70 | 98 |
| PE-0805FT153KTT | 15 @ 2.52MHz | ±10% (K) | ±5% (J) | 10 @ 2.52MHz | 23 | 6.50 | 80 |
| PE-0805FT223KTT | 22 @ 2.52MHz | ±10% (K) | ±5% (J) | 10 @ 2.52MHz | 20 | 8.00 | 68 |
| PE-0805FT333KTT | 33 @ 2.52MHz | ±10% (K) | ±5% (J) | 10 @ 2.52MHz | 17 | 10.70 | 60 |
| PE-0805FT473KTT | 47 @ 2.52MHz | ±10% (K) | ±5% (J) | 10 @ 2.52MHz | 14 | 13.80 | 55 |
| PE-0805FT683KTT | 68 @ 2.52MHz | ±10% (K) | ±5% (J) | 8 @ 2.52MHz | 11 | 17.50 | 49 |

NOTES:

1. Inductance measured using a HP4286A RF Impedance Analyzer.
2. Q measured using a HP4291A RF Impedance Analyzer with a HP16193A Test Fixture.
3. SRF measured using a HP8753C Network Analyzer.
4. R_{DC} measured using a Valhalla Scientific model 4100 ATC Digital Ohmmeter.
5. Based on a 15°C maximum temperature rise.
6. Sample Kit Part Number: **PE-0805FTKIT-T**

WIRE-WOUND RF CHIP INDUCTORS - 0805FT SERIES



Typical Q vs. Frequency



| | |
|-----------------|-----------------|
| PE-0805FT102FTT | PE-0805FT152JTT |
| PE-0805FT222JTT | PE-0805FT332JTT |
| PE-0805FT472JTT | PE-0805FT682JTT |
| PE-0805FT103JTT | PE-0805FT153JTT |
| PE-0805FT223JTT | PE-0805FT333JTT |

Typical Inductance vs. Frequency

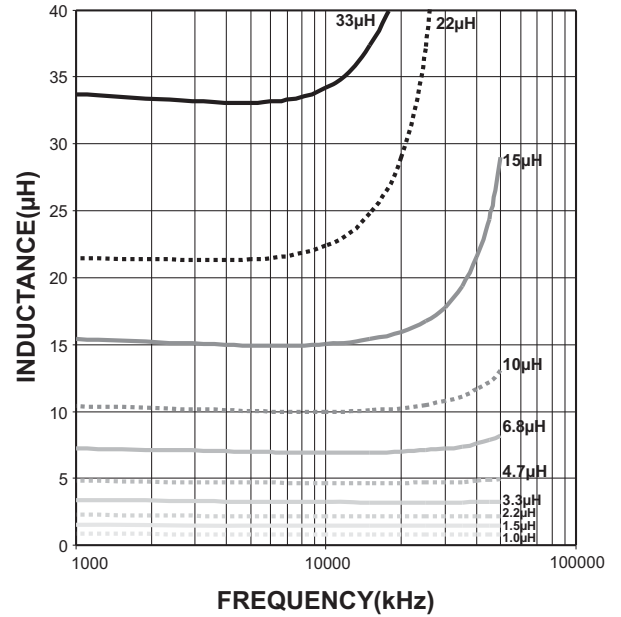

| | |
|-----------------|-----------------|
| PE-0805FT102JTT | PE-0805FT152JTT |
| PE-0805FT222JTT | PE-0805FT332JTT |
| PE-0805FT472JTT | PE-0805FT682JTT |
| PE-0805FT103JTT | PE-0805FT153JTT |
| PE-0805FT223JTT | PE-0805FT333JTT |



Mechanical



Weight 0.012 grams
Tape & Reel 2000/reel
Dimensions: inches
mm
Unless otherwise specified
all tolerances are $\pm .010$

WIRE-WOUND RF CHIP INDUCTORS - 1008CD SERIES



-  Wirewound ceramic core construction
-  High Q values and high self-resonant frequency
-  Industry standard 1008 (2520)
SMT land pattern



See page 3 for Competition Cross Reference

Electrical Specifications @ 25°C

| Part Number | Inductance ¹ (nH) | Standard Tolerance | Optional Tolerance | Q ² (MIN) | SRF ³ (MHz MIN) | R _{Dc} ⁴ (Ω MAX) | I _{Dc} ⁵ (mA MAX) |
|-----------------|---------------------------------|-----------------------|---------------------------|-------------------------|-------------------------------|---|--|
| PE-1008CD090KTT | 9,7 @ 50MHz | ±10% (K) | ±5% (J), ±2% (G), ±1% (F) | 50 @ 500MHz | 4100 | 0.09 | 1000 |
| PE-1008CD100KTT | 10 @ 50MHz | ±10% (K) | ±5% (J), ±2% (G), ±1% (F) | 50 @ 500MHz | 4100 | 0.09 | 1000 |
| PE-1008CD120KTT | 12 @ 50MHz | ±10% (K) | ±5% (J), ±2% (G), ±1% (F) | 50 @ 500MHz | 3300 | 0.09 | 1000 |
| PE-1008CD140KTT | 14,3 @ 50MHz | ±10% (K) | ±5% (J), ±2% (G), ±1% (F) | 50 @ 500MHz | 1850 | 0.10 | 1000 |
| PE-1008CD150KTT | 15 @ 50MHz | ±10% (K) | ±5% (J), ±2% (G), ±1% (F) | 50 @ 500MHz | 1850 | 0.10 | 1000 |
| PE-1008CD180KTT | 17,8 @ 50MHz | ±10% (K) | ±5% (J), ±2% (G), ±1% (F) | 50 @ 350MHz | 2500 | 0.11 | 1000 |
| PE-1008CD210KTT | 20,9 @ 50MHz | ±10% (K) | ±5% (J), ±2% (G), ±1% (F) | 55 @ 350MHz | 1800 | 0.12 | 1000 |
| PE-1008CD220KTT | 22 @ 50MHz | ±10% (K) | ±5% (J), ±2% (G), ±1% (F) | 55 @ 350MHz | 1800 | 0.12 | 1000 |
| PE-1008CD260KTT | 26,2 @ 50MHz | ±10% (K) | ±5% (J), ±2% (G), ±1% (F) | 55 @ 350MHz | 1500 | 0.13 | 1000 |
| PE-1008CD270KTT | 27 @ 50MHz | ±10% (K) | ±5% (J), ±2% (G), ±1% (F) | 55 @ 350MHz | 1500 | 0.11 | 1000 |
| PE-1008CD320KTT | 31,8 @ 50MHz | ±10% (K) | ±5% (J), ±2% (G), ±1% (F) | 60 @ 350MHz | 1600 | 0.16 | 1000 |
| PE-1008CD330KTT | 33 @ 50MHz | ±10% (K) | ±5% (J), ±2% (G), ±1% (F) | 60 @ 350MHz | 1600 | 0.14 | 1000 |
| PE-1008CD380KTT | 38,2 @ 50MHz | ±10% (K) | ±5% (J), ±2% (G), ±1% (F) | 60 @ 350MHz | 1400 | 0.15 | 1000 |
| PE-1008CD390KTT | 39 @ 50MHz | ±10% (K) | ±5% (J), ±2% (G), ±1% (F) | 60 @ 350MHz | 1400 | 0.12 | 1000 |
| PE-1008CD450KTT | 44,9 @ 50MHz | ±10% (K) | ±5% (J), ±2% (G), ±1% (F) | 65 @ 350MHz | 1200 | 0.16 | 1000 |
| PE-1008CD470KTT | 47 @ 50MHz | ±10% (K) | ±5% (J), ±2% (G), ±1% (F) | 65 @ 350MHz | 1200 | 0.08 | 1000 |
| PE-1008CD540KTT | 54 @ 50MHz | ±10% (K) | ±5% (J), ±2% (G), ±1% (F) | 65 @ 350MHz | 1150 | 0.18 | 1000 |
| PE-1008CD560KTT | 56 @ 50MHz | ±10% (K) | ±5% (J), ±2% (G), ±1% (F) | 65 @ 350MHz | 1150 | 0.12 | 1000 |
| PE-1008CD650KTT | 65 @ 50MHz | ±10% (K) | ±5% (J), ±2% (G), ±1% (F) | 65 @ 350MHz | 1100 | 0.20 | 1000 |
| PE-1008CD680KTT | 68 @ 50MHz | ±10% (K) | ±5% (J), ±2% (G), ±1% (F) | 65 @ 350MHz | 1100 | 0.07 | 1000 |
| PE-1008CD790KTT | 79 @ 50MHz | ±10% (K) | ±5% (J), ±2% (G), ±1% (F) | 60 @ 350MHz | 950 | 0.22 | 1000 |
| PE-1008CD820KTT | 82 @ 50MHz | ±10% (K) | ±5% (J), ±2% (G), ±1% (F) | 60 @ 350MHz | 950 | 0.14 | 1000 |
| PE-1008CD960KTT | 96,1 @ 25MHz | ±10% (K) | ±5% (J), ±2% (G), ±1% (F) | 60 @ 350MHz | 900 | 0.56 | 650 |
| PE-1008CD101KTT | 100 @ 25MHz | ±10% (K) | ±5% (J), ±2% (G), ±1% (F) | 60 @ 350MHz | 900 | 0.15 | 650 |
| PE-1008CD121KTT | 120 @ 25MHz | ±10% (K) | ±5% (J), ±2% (G), ±1% (F) | 60 @ 350MHz | 950 | 0.63 | 650 |
| PE-1008CD141KTT | 145,7 @ 25MHz | ±10% (K) | ±5% (J), ±2% (G), ±1% (F) | 45 @ 100MHz | 625 | 0.70 | 580 |
| PE-1008CD151KTT | 150 @ 25MHz | ±10% (K) | ±5% (J), ±2% (G), ±1% (F) | 45 @ 100MHz | 625 | 0.16 | 580 |
| PE-1008CD161KTT | 160 @ 25MHz | ±10% (K) | ±5% (J), ±2% (G), ±1% (F) | 45 @ 100MHz | 625 | 0.77 | 600 |
| PE-1008CD171KTT | 170,2 @ 25MHz | ±10% (K) | ±5% (J), ±2% (G), ±1% (F) | 45 @ 100MHz | 650 | 0.77 | 620 |
| PE-1008CD181KTT | 180 @ 25MHz | ±10% (K) | ±5% (J), ±2% (G), ±1% (F) | 45 @ 100MHz | 650 | 0.77 | 620 |
| PE-1008CD211KTT | 216 @ 25MHz | ±10% (K) | ±5% (J), ±2% (G), ±1% (F) | 45 @ 100MHz | 625 | 0.84 | 500 |
| PE-1008CD221KTT | 220 @ 25MHz | ±10% (K) | ±5% (J), ±2% (G), ±1% (F) | 45 @ 100MHz | 625 | 0.84 | 500 |
| PE-1008CD261KTT | 260,5 @ 25MHz | ±10% (K) | ±5% (J), ±2% (G), ±1% (F) | 45 @ 100MHz | 525 | 0.91 | 500 |
| PE-1008CD271KTT | 270 @ 25MHz | ±10% (K) | ±5% (J), ±2% (G), ±1% (F) | 45 @ 100MHz | 525 | 0.91 | 500 |
| PE-1008CD311KTT | 313,6 @ 25MHz | ±10% (K) | ±5% (J), ±2% (G), ±1% (F) | 45 @ 100MHz | 500 | 1.05 | 450 |
| PE-1008CD331KTT | 330 @ 25MHz | ±10% (K) | ±5% (J), ±2% (G), ±1% (F) | 45 @ 100MHz | 500 | 1.05 | 450 |
| PE-1008CD361KTT | 365 @ 25MHz | ±10% (K) | ±5% (J), ±2% (G), ±1% (F) | 45 @ 100MHz | 500 | 1.12 | 470 |
| PE-1008CD391KTT | 390 @ 25MHz | ±10% (K) | ±5% (J), ±2% (G), ±1% (F) | 45 @ 100MHz | 475 | 1.12 | 470 |
| PE-1008CD451KTT | 447 @ 25MHz | ±10% (K) | ±5% (J), ±2% (G), ±1% (F) | 45 @ 100MHz | 450 | 1.19 | 420 |
| PE-1008CD471KTT | 470 @ 25MHz | ±10% (K) | ±5% (J), ±2% (G), ±1% (F) | 45 @ 100MHz | 450 | 1.19 | 420 |
| PE-1008CD541KTT | 535 @ 25MHz | ±10% (K) | ±5% (J), ±2% (G), ±1% (F) | 45 @ 100MHz | 415 | 1.33 | 310 |
| PE-1008CD561KTT | 560 @ 25MHz | ±10% (K) | ±5% (J), ±2% (G), ±1% (F) | 45 @ 100MHz | 415 | 1.33 | 310 |
| PE-1008CD591KTT | 586 @ 25MHz | ±10% (K) | ±5% (J), ±2% (G), ±1% (F) | 45 @ 100MHz | 375 | 1.40 | 300 |
| PE-1008CD621KTT | 620 @ 25MHz | ±10% (K) | ±5% (J), ±2% (G), ±1% (F) | 45 @ 100MHz | 375 | 1.40 | 300 |
| PE-1008CD641KTT | 636 @ 25MHz | ±10% (K) | ±5% (J), ±2% (G), ±1% (F) | 45 @ 100MHz | 375 | 1.47 | 230 |
| PE-1008CD681KTT | 680 @ 25MHz | ±10% (K) | ±5% (J), ±2% (G), ±1% (F) | 45 @ 100MHz | 375 | 1.47 | 230 |
| PE-1008CD711KTT | 708,8 @ 25MHz | ±10% (K) | ±5% (J), ±2% (G), ±1% (F) | 45 @ 100MHz | 360 | 1.54 | 200 |
| PE-1008CD751KTT | 750 @ 25MHz | ±10% (K) | ±5% (J), ±2% (G), ±1% (F) | 45 @ 100MHz | 350 | 1.61 | 200 |
| PE-1008CD771KTT | 768 @ 25MHz | ±10% (K) | ±5% (J), ±2% (G), ±1% (F) | 45 @ 100MHz | 325 | 1.61 | 180 |
| PE-1008CD821KTT | 820 @ 25MHz | ±10% (K) | ±5% (J), ±2% (G), ±1% (F) | 45 @ 100MHz | 325 | 1.61 | 180 |
| PE-1008CD851KTT | 849.8 @ 25MHz | ±10% (K) | ±5% (J), ±2% (G), ±1% (F) | 35 @ 50MHz | 320 | 1.68 | 150 |

USA 858 674 8100 • Germany 49 7032 7806 0 • Singapore 65 6287 8998 • Shanghai 86 21 62787060 • China 86 755 33966678 • Taiwan 886 3 4356768

WIRE-WOUND RF CHIP INDUCTORS - 1008CD SERIES



Electrical Specifications @ 25°C (continued)

| Part Number | Inductance ¹ (nH) | Standard Tolerance | Optional Tolerance | Q ² (MIN) | SRF ³ (MHz MIN) | R _{DC} ⁴ (Ω MAX) | I _{DC} ⁵ (mA MAX) |
|-----------------|---------------------------------|-----------------------|---------------------------|-------------------------|-------------------------------|---|--|
| PE-1008CD911KTT | 909.5 @ 25MHz | ±10% (K) | ±5% (J), ±2% (G), ±1% (F) | 35 @ 50MHz | 290 | 1.75 | 150 |
| PE-1008CD102KTT | 1000 @ 25MHz | ±10% (K) | ±5% (J), ±2% (G), ±1% (F) | 35 @ 50MHz | 260 | 1.90 | 120 |
| PE-1008CD112KTT | 1184 @ 7.9MHz | ±10% (K) | ±5% (J), ±2% (G), ±1% (F) | 35 @ 50MHz | 250 | 2.00 | 310 |
| PE-1008CD122KTT | 1200 @ 7.9MHz | ±10% (K) | ±5% (J), ±2% (G), ±1% (F) | 35 @ 50MHz | 250 | 2.00 | 310 |
| PE-1008CD142KTT | 1470 @ 7.9MHz | ±10% (K) | ±5% (J), ±2% (G), ±1% (F) | 28 @ 50MHz | 200 | 2.30 | 330 |
| PE-1008CD152KTT | 1500 @ 7.9MHz | ±10% (K) | ±5% (J), ±2% (G), ±1% (F) | 28 @ 50MHz | 200 | 2.30 | 330 |
| PE-1008CD182KTT | 1792.9 @ 7.9MHz | ±10% (K) | ±5% (J), ±2% (G), ±1% (F) | 28 @ 50MHz | 160 | 2.60 | 300 |
| PE-1008CD212KTT | 2154.5 @ 7.9MHz | ±10% (K) | ±5% (J), ±2% (G), ±1% (F) | 28 @ 50MHz | 80 | 2.80 | 280 |
| PE-1008CD222KTT | 2200 @ 7.9MHz | ±10% (K) | ±5% (J), ±2% (G), ±1% (F) | 28 @ 50MHz | 80 | 2.80 | 280 |
| PE-1008CD262KTT | 2646.8 @ 7.9MHz | ±10% (K) | ±5% (J), ±2% (G), ±1% (F) | 22 @ 25MHz | 90 | 3.20 | 290 |
| PE-1008CD272KTT | 2700 @ 7.9MHz | ±10% (K) | ±5% (J), ±2% (G), ±1% (F) | 22 @ 25MHz | 90 | 3.20 | 290 |
| PE-1008CD322KTT | 3207.6 @ 7.9MHz | ±10% (K) | ±5% (J), ±2% (G), ±1% (F) | 22 @ 25MHz | 40 | 3.40 | 290 |
| PE-1008CD332KTT | 3300 @ 7.9MHz | ±10% (K) | ±5% (J), ±2% (G), ±1% (F) | 22 @ 25MHz | 40 | 3.40 | 290 |
| PE-1008CD372KTT | 3758.2 @ 7.9MHz | ±10% (K) | ±5% (J), ±2% (G), ±1% (F) | 20 @ 25MHz | 35 | 3.60 | 260 |
| PE-1008CD392KTT | 3900 @ 7.9MHz | ±10% (K) | ±5% (J), ±2% (G), ±1% (F) | 20 @ 25MHz | 35 | 3.60 | 260 |
| PE-1008CD452KTT | 4526.2 @ 7.9MHz | ±10% (K) | ±5% (J), ±2% (G), ±1% (F) | 20 @ 25MHz | 25 | 4.00 | 260 |
| PE-1008CD472KTT | 4700 @ 7.9MHz | ±10% (K) | ±5% (J), ±2% (G), ±1% (F) | 20 @ 25MHz | 25 | 4.00 | 260 |
| PE-1008CD562KTT | 5600 @ 7.9MHz | ±10% (K) | ±5% (J), ±2% (G), ±1% (F) | 20 @ 25MHz | 60 | 5.40 | 240 |
| PE-1008CD682KTT | 6800 @ 7.9MHz | ±10% (K) | ±5% (J), ±2% (G), ±1% (F) | 18 @ 7.9MHz | 40 | 4.90 | 200 |
| PE-1008CD822KTT | 8200 @ 7.9MHz | ±10% (K) | ±5% (J), ±2% (G), ±1% (F) | 18 @ 7.9MHz | 25 | 6.00 | 160 |

Notes: ***For other inductance values in 1008 size, please refer to 1008CM (pages 18-19) and 1008CQ (pages 20-21)***

- Inductance measured using a HP4286A RF Impedance Analyzer.
- Q measured using a HP4291A RF Impedance Analyzer with a HP16193A Test Fixture.
- SRF measured using a HP8753C Network Analyzer.
- R_{DC} measured using Valhalla Scientific model 4100 ATC Digital Ohmmeter.
- Based on a 15°C maximum temperature rise.
- Sample Kit Part Number: **PE-1008CDKIT-T**
- Component Weight: 0.032 grams typical.
- These components are 0.055" in height.

Typical Q vs Frequency



Typical Inductance vs Frequency



Mechanical



Dimensions: $\frac{\text{Inches}}{\text{mm}}$

Unless otherwise specified, all tolerances are $\pm \frac{.010}{0.25}$

WIRE-WOUND RF CHIP INDUCTORS - 1008CM SERIES



-  Wirewound ceramic core construction
-  High Q values and self-resonant frequency
-  Industry standard 1008 (2520) surface mount land pattern



See page 3 for Competition Cross Reference

Electrical Specifications @ 25°C

| Part Number | Inductance ¹ (nH) | Standard Tolerance | Optional Tolerance | Q ² (MIN) | SRF Min ³ (MHz MIN) | R _{DC} ⁴ (Ω MAX) | I _{DC} ⁵ (mA MAX) |
|-----------------|---------------------------------|-----------------------|-----------------------|-------------------------|-----------------------------------|---|--|
| PE-1008CM100KTT | 10 @ 50MHz | ±10% (K) | ±5% (J), ±2% (G) | 50 @ 500MHz | 4500 | 0.09 | 1000 |
| PE-1008CM120KTT | 12 @ 50MHz | ±10% (K) | ±5% (J), ±2% (G) | 65 @ 500MHz | 2300 | 0.09 | 1000 |
| PE-1008CM150KTT | 15 @ 50MHz | ±10% (K) | ±5% (J), ±2% (G) | 55 @ 500MHz | 1850 | 0.19 | 1000 |
| PE-1008CM180KTT | 18 @ 50MHz | ±10% (K) | ±5% (J), ±2% (G) | 55 @ 350MHz | 2200 | 0.06 | 1000 |
| PE-1008CM220KTT | 22 @ 50MHz | ±10% (K) | ±5% (J), ±2% (G) | 55 @ 350MHz | 1800 | 0.09 | 1000 |
| PE-1008CM270KTT | 27 @ 50MHz | ±10% (K) | ±5% (J), ±2% (G) | 60 @ 350MHz | 1500 | 0.11 | 1000 |
| PE-1008CM330KTT | 33 @ 50MHz | ±10% (K) | ±5% (J), ±2% (G) | 60 @ 350MHz | 1800 | 0.18 | 800 |
| PE-1008CM390KTT | 39 @ 50MHz | ±10% (K) | ±5% (J), ±2% (G) | 70 @ 350MHz | 1400 | 0.12 | 1000 |
| PE-1008CM470KTT | 47 @ 50MHz | ±10% (K) | ±5% (J), ±2% (G) | 70 @ 350MHz | 1200 | 0.08 | 1000 |
| PE-1008CM560KTT | 56 @ 50MHz | ±10% (K) | ±5% (J), ±2% (G) | 60 @ 350MHz | 1150 | 0.12 | 1000 |
| PE-1008CM680KTT | 68 @ 50MHz | ±10% (K) | ±5% (J), ±2% (G) | 70 @ 350MHz | 1100 | 0.07 | 1000 |
| PE-1008CM820KTT | 82 @ 50MHz | ±10% (K) | ±5% (J), ±2% (G) | 65 @ 350MHz | 950 | 0.14 | 950 |
| PE-1008CM101KTT | 100 @ 25MHz | ±10% (K) | ±5% (J), ±2% (G) | 65 @ 350MHz | 900 | 0.15 | 650 |
| PE-1008CM121KTT | 120 @ 25MHz | ±10% (K) | ±5% (J), ±2% (G) | 60 @ 350MHz | 825 | 0.22 | 650 |
| PE-1008CM151KTT | 150 @ 25MHz | ±10% (K) | ±5% (J), ±2% (G) | 50 @ 100MHz | 625 | 0.16 | 580 |
| PE-1008CM161KTT | 160 @ 25MHz | ±10% (K) | ±5% (J), ±2% (G) | 50 @ 100MHz | 625 | 0.25 | 600 |
| PE-1008CM181KTT | 180 @ 25MHz | ±10% (K) | ±5% (J), ±2% (G) | 50 @ 100MHz | 650 | 0.25 | 600 |
| PE-1008CM201KTT | 200 @ 25MHz | ±10% (K) | ±5% (J), ±2% (G) | 50 @ 100MHz | 630 | 0.24 | 580 |
| PE-1008CM221KTT | 220 @ 25MHz | ±10% (K) | ±5% (J), ±2% (G) | 50 @ 100MHz | 625 | 0.28 | 500 |
| PE-1008CM271KTT | 270 @ 25MHz | ±10% (K) | ±5% (J), ±2% (G) | 45 @ 100MHz | 525 | 0.50 | 500 |
| PE-1008CM331KTT | 330 @ 25MHz | ±10% (K) | ±5% (J), ±2% (G) | 50 @ 100MHz | 500 | 0.80 | 450 |
| PE-1008CM371KTT | 370 @ 25MHz | ±10% (K) | ±5% (J), ±2% (G) | 50 @ 100MHz | 490 | 0.80 | 430 |
| PE-1008CM391KTT | 390 @ 25MHz | ±10% (K) | ±5% (J), ±2% (G) | 50 @ 100MHz | 475 | 0.75 | 425 |
| PE-1008CM401KTT | 400 @ 25MHz | ±10% (K) | ±5% (J), ±2% (G) | 50 @ 100MHz | 470 | 0.75 | 420 |
| PE-1008CM471KTT | 470 @ 25MHz | ±10% (K) | ±5% (J), ±2% (G) | 50 @ 100MHz | 450 | 0.70 | 350 |
| PE-1008CM561KTT | 560 @ 25MHz | ±10% (K) | ±5% (J), ±2% (G) | 50 @ 100MHz | 425 | 0.80 | 350 |
| PE-1008CM621KTT | 620 @ 25MHz | ±10% (K) | ±5% (J), ±2% (G) | 45 @ 100MHz | 375 | 1.90 | 200 |
| PE-1008CM681KTT | 680 @ 25MHz | ±10% (K) | ±5% (J), ±2% (G) | 45 @ 100MHz | 375 | 2.30 | 200 |
| PE-1008CM751KTT | 750 @ 25MHz | ±10% (K) | ±5% (J), ±2% (G) | 45 @ 100MHz | 350 | 1.60 | 200 |
| PE-1008CM821KTT | 820 @ 25MHz | ±10% (K) | ±5% (J), ±2% (G) | 40 @ 100MHz | 325 | 3.30 | 200 |
| PE-1008CM911KTT | 910 @ 25MHz | ±10% (K) | ±5% (J), ±2% (G) | 40 @ 50MHz | 300 | 2.10 | 200 |
| PE-1008CM102KTT | 1000 @ 25MHz | ±10% (K) | ±5% (J), ±2% (G) | 40 @ 50MHz | 300 | 1.80 | 200 |
| PE-1008CM122KTT | 1200 @ 10MHz | ±10% (K) | ±5% (J), ±2% (G) | 40 @ 50MHz | 250 | 3.00 | 200 |
| PE-1008CM152KTT | 1500 @ 10MHz | ±10% (K) | ±5% (J), ±2% (G) | 40 @ 50MHz | 200 | 4.00 | 150 |
| PE-1008CM182KTT | 1800 @ 10MHz | ±10% (K) | ±5% (J), ±2% (G) | 40 @ 50MHz | 150 | 5.09 | 150 |
| PE-1008CM222KTT | 2200 @ 10MHz | ±10% (K) | ±5% (J), ±2% (G) | 30 @ 25MHz | 80 | 5.85 | 150 |
| PE-1008CM272KTT | 2700 @ 10MHz | ±10% (K) | ±5% (J), ±2% (G) | 30 @ 25MHz | 90 | 7.70 | 150 |
| PE-1008CM332KTT | 3300 @ 10MHz | ±10% (K) | ±5% (J), ±2% (G) | 25 @ 15MHz | 40 | 7.80 | 150 |
| PE-1008CM392KTT | 3900 @ 10MHz | ±10% (K) | ±5% (J), ±2% (G) | 20 @ 15MHz | 35 | 8.30 | 135 |
| PE-1008CM472KTT | 4700 @ 10MHz | ±10% (K) | ±5% (J), ±2% (G) | 16 @ 15MHz | 25 | 6.00 | 150 |

Notes:

1. Inductance measured using a HP4191A RF Impedance Analyzer.
2. Q measured using a HP4291A RF Impedance Analyzer with a HP16193A Test Fixture.
3. SRF measured using a HP8753C Network Analyzer.
4. R_{DC} measured using a Valhalla Scientific model 4100 ATC Digital Ohmmeter.
5. Based on a 15°C maximum temperature rise.
6. Component Weight: 0.032 grams typical.

WIRE-WOUND RF CHIP INDUCTORS - 1008CM SERIES



Typical Q vs Frequency



Typical Inductance vs Frequency



Mechanical



SUGGESTED PAD LAYOUT



Dimensions: $\frac{\text{Inches}}{\text{mm}}$

Unless otherwise specified
all tolerances are $\pm \frac{.010}{0,25}$



WIRE-WOUND RF CHIP INDUCTORS - 1008CQ SERIES

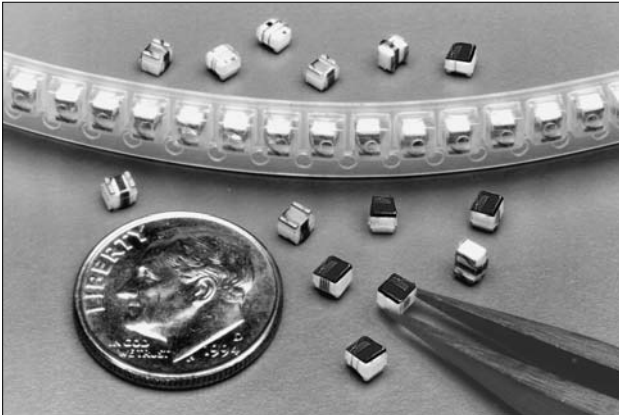

-  Wirewound ceramic core construction
-  High Q values and I_{dc} values
-  High self-resonant frequency
-  Industry standard 1008 (2520) surface mount land pattern



See page 3 for Competition Cross Reference

Electrical Specifications @ 25°C

| Part Number | Inductance ¹ (nH) | Standard Tolerance | Optional Tolerance | Q ² (MIN) | SRF Min ³ (MHz MIN) | R _{DC} ⁴ (Ω MAX) | I _{DC} ⁵ (mA MAX) |
|-----------------|---------------------------------|-----------------------|-----------------------|-------------------------|-----------------------------------|---|--|
| PE-1008CQ4N1KTT | 4.1 @ 50MHz | ±10% (K) | ±5% (J) | 75 @ 1500MHz | 6000 | 0.05 | 1600 |
| PE-1008CQ100KTT | 10 @ 50MHz | ±10% (K) | ±5% (J) | 60 @ 500MHz | 3600 | 0.06 | 1600 |
| PE-1008CQ120KTT | 12 @ 50MHz | ±10% (K) | ±5% (J) | 70 @ 500MHz | 2800 | 0.06 | 1500 |
| PE-1008CQ180KTT | 18 @ 50MHz | ±10% (K) | ±5% (J) | 62 @ 350MHz | 2700 | 0.07 | 1400 |
| PE-1008CQ220KTT | 22 @ 50MHz | ±10% (K) | ±5% (J) | 62 @ 350MHz | 2050 | 0.07 | 1400 |
| PE-1008CQ330KTT | 33 @ 50MHz | ±10% (K) | ±5% (J) | 75 @ 350MHz | 1700 | 0.09 | 1300 |
| PE-1008CQ390KTT | 39 @ 50MHz | ±10% (K) | ±5% (J) | 75 @ 350MHz | 1300 | 0.09 | 1300 |
| PE-1008CQ470KTT | 47 @ 50MHz | ±10% (K) | ±5% (J) | 75 @ 350MHz | 1450 | 0.12 | 1200 |
| PE-1008CQ560KTT | 56 @ 50MHz | ±10% (K) | ±5% (J) | 75 @ 350MHz | 1230 | 0.12 | 1200 |
| PE-1008CQ680KTT | 68 @ 50MHz | ±10% (K) | ±5% (J) | 80 @ 350MHz | 1150 | 0.13 | 1100 |
| PE-1008CQ820KTT | 82 @ 50MHz | ±10% (K) | ±5% (J) | 80 @ 350MHz | 1060 | 0.16 | 1100 |
| PE-1008CQ101KTT | 100 @ 50MHz | ±10% (K) | ±5% (J) | 62 @ 350MHz | 820 | 0.16 | 1000 |
| PE-1008CQ121KTT | 120 @ 50MHz | ±10% (K) | ±5% (J) | 62 @ 350MHz | 800 | 0.17 | 1000 |
| PE-1008CQ151KTT | 150 @ 50MHz | ±10% (K) | ±5% (J) | 60 @ 350MHz | 750 | 0.21 | 950 |
| PE-1008CQ181KTT | 180 @ 50MHz | ±10% (K) | ±5% (J) | 40 @ 350MHz | 720 | 0.23 | 920 |
| PE-1008CQ221KTT | 220 @ 50MHz | ±10% (K) | ±5% (J) | 35 @ 350MHz | 680 | 0.29 | 900 |
| PE-1008CQ271KTT | 270 @ 50MHz | ±10% (K) | ±5% (J) | 35 @ 350MHz | 600 | 0.55 | 600 |
| PE-1008CQ331KTT | 330 @ 50MHz | ±10% (K) | ±5% (J) | 35 @ 100MHz | 550 | 0.60 | 550 |
| PE-1008CQ391KTT | 390 @ 50MHz | ±10% (K) | ±5% (J) | 35 @ 350MHz | 500 | 0.82 | 470 |

Notes:

1. Inductance measured using a HP4191A RF Impedance Analyzer.
2. Q measured using a HP4291A RF Impedance Analyzer with a HP16193A Test Fixture.
3. SRF measured using a HP8753C Network Analyzer.
4. R_{DC} measured using a Valhalla Scientific model 4100 ATC Digital Ohmmeter.
5. Based on a 15°C maximum temperature rise.
6. Component Weight: 0.032 grams typical.

WIRE-WOUND RF CHIP INDUCTORS - 1008CQ SERIES



Typical Q vs Frequency



Typical Inductance vs Frequency



Mechanical

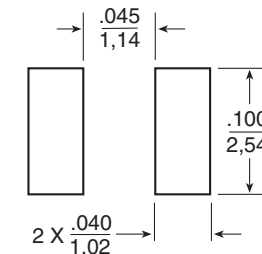

SUGGESTED PAD LAYOUT

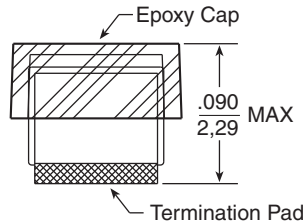

Dimensions: $\frac{\text{Inches}}{\text{mm}}$

Unless otherwise specified
all tolerances are $\pm .010$
 $0,25$

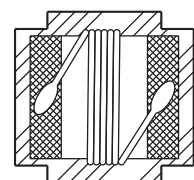

WIRE-WOUND RF CHIP INDUCTORS - 1206CD SERIES



-  Wirewound ceramic core construction
-  High Q values and self-resonant frequency
-  Industry standard 1206 (3216) SMT land pattern



See page 3 for Competition Cross Reference

Electrical Specifications @ 25°C

| Part Number | Inductance ¹ (nH) | Standard Tolerance | Optional Tolerance | Q ² (MIN) | SRF Min ³ (MHz MIN) | R _{DC} ⁴ (Ω MAX) | I _{DC} ⁵ (mA MAX) |
|-----------------|---------------------------------|-----------------------|-----------------------|-------------------------|-----------------------------------|---|--|
| PE-1206CD030KTT | 3.3 @ 100MHz | ±10% (K) | ±5% (J), ±2% (G) | 30 @ 300MHz | 6200 | 0.05 | 1000 |
| PE-1206CD060KTT | 6.8 @ 100MHz | ±10% (K) | ±5% (J), ±2% (G) | 30 @ 300MHz | 5500 | 0.07 | 1000 |
| PE-1206CD100KTT | 10 @ 100MHz | ±10% (K) | ±5% (J), ±2% (G) | 40 @ 300MHz | 4000 | 0.08 | 1000 |
| PE-1206CD120KTT | 12 @ 100MHz | ±10% (K) | ±5% (J), ±2% (G) | 40 @ 300MHz | 3200 | 0.08 | 1000 |
| PE-1206CD150KTT | 15 @ 100MHz | ±10% (K) | ±5% (J), ±2% (G) | 40 @ 300MHz | 3200 | 0.10 | 1000 |
| PE-1206CD180KTT | 18 @ 100MHz | ±10% (K) | ±5% (J), ±2% (G) | 50 @ 300MHz | 2800 | 0.10 | 1000 |
| PE-1206CD220KTT | 22 @ 100MHz | ±10% (K) | ±5% (J), ±2% (G) | 50 @ 300MHz | 2200 | 0.10 | 1000 |
| PE-1206CD270KTT | 27 @ 100MHz | ±10% (K) | ±5% (J), ±2% (G) | 50 @ 300MHz | 1800 | 0.11 | 1000 |
| PE-1206CD330KTT | 33 @ 100MHz | ±10% (K) | ±5% (J), ±2% (G) | 55 @ 300MHz | 1800 | 0.11 | 1000 |
| PE-1206CD390KTT | 39 @ 100MHz | ±10% (K) | ±5% (J), ±2% (G) | 55 @ 300MHz | 1800 | 0.12 | 1000 |
| PE-1206CD470KTT | 47 @ 100MHz | ±10% (K) | ±5% (J), ±2% (G) | 55 @ 300MHz | 1500 | 0.13 | 1000 |
| PE-1206CD560KTT | 56 @ 100MHz | ±10% (K) | ±5% (J), ±2% (G) | 55 @ 300MHz | 1450 | 0.14 | 1000 |
| PE-1206CD680KTT | 68 @ 100MHz | ±10% (K) | ±5% (J), ±2% (G) | 55 @ 300MHz | 1200 | 0.26 | 900 |
| PE-1206CD820KTT | 82 @ 100MHz | ±10% (K) | ±5% (J), ±2% (G) | 55 @ 300MHz | 1200 | 0.21 | 900 |
| PE-1206CD101KTT | 100 @ 100 MHz | ±10% (K) | ±5% (J), ±2% (G) | 55 @ 300MHz | 1100 | 0.26 | 850 |
| PE-1206CD121KTT | 120 @ 100MHz | ±10% (K) | ±5% (J), ±2% (G) | 60 @ 300MHz | 1100 | 0.26 | 800 |
| PE-1206CD151KTT | 150 @ 100MHz | ±10% (K) | ±5% (J), ±2% (G) | 60 @ 300MHz | 950 | 0.31 | 750 |
| PE-1206CD181KTT | 180 @ 50MHz | ±10% (K) | ±5% (J), ±2% (G) | 60 @ 300MHz | 900 | 0.43 | 700 |
| PE-1206CD221KTT | 220 @ 50MHz | ±10% (K) | ±5% (J), ±2% (G) | 60 @ 300MHz | 760 | 0.50 | 670 |
| PE-1206CD271KTT | 270 @ 50MHz | ±10% (K) | ±5% (J), ±2% (G) | 55 @ 300MHz | 730 | 0.56 | 630 |
| PE-1206CD331KTT | 330 @ 50MHz | ±10% (K) | ±5% (J), ±2% (G) | 45 @ 150MHz | 650 | 0.62 | 590 |
| PE-1206CD391KTT | 390 @ 50MHz | ±10% (K) | ±5% (J), ±2% (G) | 45 @ 150MHz | 600 | 0.75 | 530 |
| PE-1206CD471KTT | 470 @ 50MHz | ±10% (K) | ±5% (J), ±2% (G) | 45 @ 150MHz | 550 | 1.30 | 490 |
| PE-1206CD561KTT | 560 @ 35MHz | ±10% (K) | ±5% (J), ±2% (G) | 45 @ 150MHz | 470 | 1.34 | 460 |
| PE-1206CD621KTT | 620 @ 35MHz | ±10% (K) | ±5% (J), ±2% (G) | 45 @ 150MHz | 470 | 1.58 | 430 |
| PE-1206CD681KTT | 680 @ 35MHz | ±10% (K) | ±5% (J), ±2% (G) | 45 @ 150MHz | 450 | 1.58 | 430 |
| PE-1206CD751KTT | 750 @ 35MHz | ±10% (K) | ±5% (J), ±2% (G) | 45 @ 150MHz | 440 | 2.25 | 400 |
| PE-1206CD821KTT | 820 @ 35MHz | ±10% (K) | ±5% (J), ±2% (G) | 45 @ 150MHz | 420 | 1.82 | 400 |
| PE-1206CD911KTT | 910 @ 35MHz | ±10% (K) | ±5% (J), ±2% (G) | 45 @ 150MHz | 410 | 2.95 | 400 |
| PE-1206CD102KTT | 1000 @ 35MHz | ±10% (K) | ±5% (J), ±2% (G) | 45 @ 150MHz | 400 | 2.80 | 320 |
| PE-1206CD122KTT | 1200 @ 35MHz | ±10% (K) | ±5% (J), ±2% (G) | 45 @ 150MHz | 380 | 3.20 | 300 |

Notes:

1. Inductance measured using a HP4286A RF Impedance Analyzer.
2. Q measured using a HP4291A RF Impedance Analyzer with a HP16193A Test Fixture.
3. SRF measured using a HP8753C Network Analyzer.
4. R_{DC} measured using a Valhalla Scientific model 4100 ATC Digital Ohmmeter.
5. Based on a 15°C maximum temperature rise.
6. Sample Kit Part Number: **PE-1206CD KIT-T**
7. Component Weight: 0.035 grams typical.
8. These components are 0.060" in height.

USA 858 674 8100 • Germany 49 7032 7806 0 • Singapore 65 6287 8998 • Shanghai 86 21 62787060 • China 86 755 33966678 • Taiwan 886 3 4356768

WIRE-WOUND RF CHIP INDUCTORS - 1206CD SERIES



Typical Q vs Frequency



Typical Inductance vs Frequency



Mechanical



WIRE-WOUND RF CHIP INDUCTORS



Application Notes

The Basics of Wire-Wound Chip Inductors

Pulse currently supplies high quality magnetic products to companies such as 3COM, Cisco, Ericsson, Intel, Marconi, Nokia and Nortel and has been active in the field of RF engineering, since the launch of its first wire-wound 1008 chip product in 1982. Pulse now offers seven ranges of wire-wound chip from 0402 to 1206 (see table 1.0 below): the "CD Range" with 100% compatibility to other market leaders, and the "CM and CQ ranges" with improved electrical performance or alternative inductance values with a ceramic core construction; the FT series with a Ferrite core construction.

In recent years, Pulse has leveraged its strength within the Telecoms and Networking industry to extend its product range to encompass RF products for the Cable Modem, CATV, MMDS and TETRA markets. Pulse now also offers Wide Bandwidth RF Transformers, Splitter Combiners, Couplers, Diplexers, Low Pass Filters and High Power Impedance Matching Transformers. To explore the complete range of RF products, visit the Pulse website:

http://www.pulseeng.com./Products/finder/rf_hfc_cable.htm for cable products and

<http://www.pulseeng.com/scripts/finder/rfind/mcis.cfm> for RF chip inductors.

| Pulse Part No. | Inductance Range (nH) | Number of Values | Tolerance Range | Availability |
|----------------|-----------------------|------------------|-----------------|--------------------|
| PE-0402CD | 1.0 ~ 120 | 48 | 2, 5 & 10% | In Mass Production |
| PE-0603CD | 1.6 ~ 390 | 55 | 2, 5 & 10% | In Mass Production |
| PE-0805CD | 2.8 ~ 1500 | 40 | 1, 2, 5 & 10% | In Mass Production |
| PE-0805CM | 3.3 ~ 820 | 27 | 2, 5 & 10% | In Mass Production |
| PE-0805FT | 1000 ~ 68000 | 12 | 5 & 10% | In Mass Production |
| PE-1008CD | 4.0 ~ 8200 | 71 | 1, 2, 5 & 10% | In Mass Production |
| PE-1008CM | 4.7 ~ 4700 | 40 | 2, 5 & 10% | In Mass Production |
| PE-1008CQ | 3.0 ~ 390 | 19 | 5 & 10% | In Mass Production |
| PE-1206CD | 3.3 ~ 1200 | 31 | 2, 5 & 10% | In Mass Production |

Table 1.0 Pulse Chip Inductor Product Range

Competing Chip Inductor Types

Capacitor and resistors are available in a wide variety of sizes and component values and it is possible to purchase almost any value, tolerance or other rating. Inductors, on the other hand, are not so readily available and engineers may find it necessary to wind their own inductors to get a specific value of inductance.

There are mainly 3 varieties of inductor in common use today and they are wire-wound, multi-layer and drum core chip inductors. The primary differences between these competing types are the core material used to enhance the inductance of coil and the construction method. Wire is wound around a ceramic or ferrite bobbin or in the case of multi-layer the coil is formed by interconnecting layers of conductive material printed on a ceramic substrate.

Table 2.0 indicates that the performance merits of wire-wound inductors versus the alternative multi-layer and drum core platforms. If price were the only consideration then, of course, there would be no market available for wire-wound chip inductors. But price is not the only consideration, since RF engineers must also consider the needs of the application in terms of Q factor, I_{dc} (maximum current carrying capacity), R_{dc} (resistance at dc), Tolerance and SRF (self-resonant or series resonant frequency).

| SMT | Technology | Material Substrate | Q Factor | SRF | I _{dc} | Tolerance |
|---------------|------------|--------------------|----------|------|-----------------|-----------|
| Chip Inductor | Wire-wound | Ceramic | High | High | High | Good |
| Chip Inductor | Wire-wound | Ferrite | Low | Low | High | Poor |
| Multi-layer | Printed | Ceramic | Low | Low | Low | Poor |
| Drum Core | Wire-wound | Ferrite | Low | Low | Low | Poor |

Table 2.0 Summary of Chip Inductor Relative Performance

WIRE-WOUND RF CHIP INDUCTORS

Application Notes

The Inductor Basics

An inductor is formed by winding a wire around a ceramic or ferrite core to increase the magnetic flux linkage between the turns of the coil. The majority of high frequency inductors above 50MHz are formed on a ceramic bobbin or substrate. Nonmagnetic cores (ceramic cores) have the opposite effect to a magnetic core in that they reduce instead of increase the inductance of the coil. Ceramic cores are mainly used to reduce the RF core losses as the high frequency currents mainly flow near the surface of the conductor. The resistance that a conductor offers to the high frequency alternating current is much greater than the resistance of the same conductor to direct current (dc) and is known as the skin effect. The skin effect is a characteristic of conductors that carry alternating current and is much more pronounced in coils than in straight conductors.

Skin effect causes the current in the conductor to be much denser near the surface of the conductor than at its centre. Consequentially, as the instantaneous value of the alternating current changes the inductance of a conductor in its interior is much greater than the instantaneous inductance near its surface. The result is more current flows near the surface or "skin" of the conductor than at its centre. Since the inductance of the coil increases proportionally to the increasing frequency, the skin effect also increases as the frequency is increased.

Another source of loss is the dielectric material used to form the body of the inductor. There is no perfect insulator and so dielectric losses can not be avoided at very high frequencies. Dielectric losses, like skin effect also tend to increase the effective resistance of a coil at high frequencies.

Whilst there is no perfect component compared to a resistor or capacitor, inductors are probably the component most prone to changing its performance over frequency. Figure 1.0 illustrates what a real world inductor looks like at RF frequencies and the resultant equivalent circuit.



Fig. 1.0 A shows how capacitive coupling (C_d) can occur between two wires, when the wires are placed in close proximity to one another and only separated by a dielectric. The resistance (R_s) is a representation of the wire resistance that exists in a wire. **Fig. 1.0 B** shows a representation of the lumped resistive, capacitive and inductive component elements of an inductor.

WIRE-WOUND RF CHIP INDUCTORS

Application Notes

The Inductor Basics *(continued)*

The effect of C_d can have a dramatic effect upon the impedance of the inductor as illustrated in Fig 2.0, because "fringe" effects become dominant at high frequencies. At low frequencies the inductor's reactance parallels that of an ideal inductor. With increasing frequency the reactance of the inductor departs from the ideal curve and increases at a much faster rate until it reaches a peak value at the inductor's parallel resonant frequency (F_r). Above F_r the inductor's reactance begins to decrease with increasing frequency and thus the inductor begins to look like a capacitor. The series resistance (R_s) of the coil prevents the impedance of the inductor from reaching infinity at resonance (F_r). Another effect of R_s is to broaden the resonant peak of the impedance curve at F_r .

Comparisons made between inductors at near to F_r will produce an inaccurate representation of the inductor's performance. This can lead to problems in the end application since the performance of one inductor to another may vary quite markedly since the performance of the inductor is dominated by the parasitic content (distributed capacitance C_d) of the inductor.



Fig. 2.0 Impedance and Inductance Characteristic of a Real World Inductor

WIRE-WOUND RF CHIP INDUCTORS

Application Notes



Q factor / SRF

The ratio of an inductor's reactance (XL) to its series resistance (Rs) is often used as measure of the quality factor of the inductor. The larger the ratio, the better the inductor. The quality factor of an inductor is often referred to as the Q of the inductor. If the inductor were constructed from a perfect conductor (zero loss), its Q would be infinite. Of course this is impossible, and so the Q of an inductor will always have some finite value.

The Q factor, Fr and SRF of an inductor are directly linked to one another. If the test frequency is near Fr or SRF, the inductor results may be misleading by very wide margins, since the result is dominated by distributed capacitance reactance. To overcome this problem, the test frequency of the inductor is normally located at a point on the inductor's curve where the reactance of the inductor approaches that of an ideal inductor, so that component to component variations are kept to a minimum since the parasitic contribution is also at a minimum. To overcome this problem, RF engineers should select an inductor with the highest test frequency possible to guarantee the quality of the inductor.

At low frequencies, the Q of an inductor is very good because the only resistance in the winding is the dc resistance of the wire which is very small (Fig. 2.0). As mentioned earlier, as the frequency increases, the skin effect increases to degrade the Q of the inductor. At low frequencies, the Q increases directly inline with the reactance (XL) since the skin effect has not become noticeable. The Q continues to rise, but as the frequency approaches Fr, the skin effect starts to become a dominant, reducing the rate of increase. At Fr, the series resistance and reactance are increasing at the same rate. Above Fr, the distributed capacitance Cd and skin effect of the winding combine together to decrease the Q of the inductor to zero at SRF.

Understanding Inductor Curves

RF design engineers require inductors to meet the following requirements:

1. Low cost
2. Compatibility to the competition
 - Q, SRF and useable frequency range => competition
3. Component to component variation small
4. Performance approaches that of an ideal inductor
 - High Q (low series resistance)
 - High SRF (low distributed capacitance)

| | Ideal Inductor | | Real World Inductor | |
|--------------------------------|----------------|--------------|---------------------|---------------------|
| Distributed Capacitance | Cd = 0 | Infinite SRF | Cd = Min | High SRF High Fr |
| Series resistor | Rs = 0 | Infinite Q | Rs = Min | High Q High Fr |

3.0 Characteristics of a Real World Inductor Vs Ideal Inductor

Determining the Inductor Equivalent Circuit

To determine the inductor equivalent circuit, an RF engineer must deduce the value of Rs and Cd from the curves supplied by the inductor manufacturer. To do this, the following equations can be used. Of course, the values deduced only apply at one specific frequency. The recommended frequency at which the inductor is used within the application should be an order of magnitude ($\div 10$) below the SRF, and preferably not near than $\frac{1}{2}$ Fr.

Equation 1: $F_c < \frac{SRF}{10}$ and/or $< \frac{FR}{2}$

Equation 2: $R_s = \frac{X_L}{Q} = \frac{2 * \pi * F_c * L}{Q}$

Equation 3: $C_d = \frac{1}{(2 * \pi * SRF)^2 * L}$

Where:

- Fc** = Centre frequency of application / intended operation
- SRF** = Series resonant or self resonant frequency of the inductor
- π** = 3.14159
- L** = Inductor value

WIRE-WOUND RF CHIP INDUCTORS

Sales Offices



| | | | | | |
|---|--|--|---|---|--|
| Pulse Worldwide Headquarters 12220 World Trade Dr. San Diego, CA 92128 U.S.A. www.pulseeng.com Tel: 858 674 8100 | Pulse Europe Einsteinstrasse 1D-71083 Herrenberg Germany Tel: 49 7032 7806 0 | Pulse China Headquarters B402, Shenzhen Academy of Aerospace Technology Bldg. 10th Kejinan Rd. High-Tech Zone Nanshan District Shenzen, PR China 518057 TEL: 86 755 33966678 | Pulse North China Room 1503 XinYin Building No. 888 YiShan Rd. Shanghai 200233 China Tel: 86 21 54643211/2 | Pulse South Asia 135 Joo Seng Rd. #03-02 PM Industrial Bldg. Singapore 368363 TEL: 65 6287 8998 | Pulse North Asia No. 26, Kao Ching Rd. Yang Mei Chen Taoyuan Hsien Taiwan R. O. C. Tel: 886 3 4643715 |
|---|--|--|---|---|--|

Performance warranty of products offered on this data sheet is limited to the parameters specified. Data is subject to change without notice. Other brand and product names mentioned herein may be trademarks or registered trademarks of their respective owners.

Компания «Океан Электроники» предлагает заключение долгосрочных отношений при поставках импортных электронных компонентов на взаимовыгодных условиях!

Наши преимущества:

- Поставка оригинальных импортных электронных компонентов напрямую с производств Америки, Европы и Азии, а так же с крупнейших складов мира;
- Широкая линейка поставок активных и пассивных импортных электронных компонентов (более 30 млн. наименований);
- Поставка сложных, дефицитных, либо снятых с производства позиций;
- Оперативные сроки поставки под заказ (от 5 рабочих дней);
- Экспресс доставка в любую точку России;
- Помощь Конструкторского Отдела и консультации квалифицированных инженеров;
- Техническая поддержка проекта, помощь в подборе аналогов, поставка прототипов;
- Поставка электронных компонентов под контролем ВП;
- Система менеджмента качества сертифицирована по Международному стандарту ISO 9001;
- При необходимости вся продукция военного и аэрокосмического назначения проходит испытания и сертификацию в лаборатории (по согласованию с заказчиком);
- Поставка специализированных компонентов военного и аэрокосмического уровня качества (Xilinx, Altera, Analog Devices, Intersil, Interpoint, Microsemi, Actel, Aeroflex, Peregrine, VPT, Syfer, Eurofarad, Texas Instruments, MS Kennedy, Miteq, Cobham, E2V, MA-COM, Hittite, Mini-Circuits, General Dynamics и др.);

Компания «Океан Электроники» является официальным дистрибьютором и эксклюзивным представителем в России одного из крупнейших производителей разъемов военного и аэрокосмического назначения «**JONHON**», а так же официальным дистрибьютором и эксклюзивным представителем в России производителя высокотехнологичных и надежных решений для передачи СВЧ сигналов «**FORSTAR**».



JONHON

«**JONHON**» (основан в 1970 г.)

Разъемы специального, военного и аэрокосмического назначения:

(Применяются в военной, авиационной, аэрокосмической, морской, железнодорожной, горно- и нефтедобывающей отраслях промышленности)

«**FORSTAR**» (основан в 1998 г.)

ВЧ соединители, коаксиальные кабели,
кабельные сборки и микроволновые компоненты:

(Применяются в телекоммуникациях гражданского и специального назначения, в средствах связи, РЛС, а так же военной, авиационной и аэрокосмической отраслях промышленности).



Телефон: 8 (812) 309-75-97 (многоканальный)

Факс: 8 (812) 320-03-32

Электронная почта: ocean@oceanchips.ru

Web: <http://oceanchips.ru/>

Адрес: 198099, г. Санкт-Петербург, ул. Калинина, д. 2, корп. 4, лит. А